

# SWEEP MAPS: A CONTINUOUS FAMILY OF SORTING ALGORITHMS

DREW ARMSTRONG, NICHOLAS A. LOEHR, AND GREGORY S. WARRINGTON

ABSTRACT. We define a family of maps on lattice paths, called *sweep maps*, that assign levels to each step in the path and sort steps according to their level. Surprisingly, although sweep maps act by sorting, they appear to be bijective in general. The sweep maps give concise combinatorial formulas for the  $q, t$ -Catalan numbers, the higher  $q, t$ -Catalan numbers, the  $q, t$ -square numbers, and many more general polynomials connected to the nabla operator and rational Catalan combinatorics. We prove that many algorithms that have appeared in the literature (including maps studied by Andrews, Egge, Gorsky, Haglund, Hanusa, Jones, Killpatrick, Krattenthaler, Kremer, Orsina, Mazin, Papi, Vaillé, and the present authors) are all special cases of the sweep maps or their inverses. The sweep maps provide a very simple unifying framework for understanding all of these algorithms. We explain how inversion of the sweep map (which is an open problem in general) can be solved in known special cases by finding a “bounce path” for the lattice paths under consideration. We also define a generalized sweep map acting on words over arbitrary alphabets with arbitrary weights, which is also conjectured to be bijective.

## 1. INTRODUCTION

This paper introduces a family of sorting maps on words that we call *sweep maps*. In its simplest form, a sweep map  $sw_{r,s}$  uses coprime parameters  $r$  and  $s$  to associate a *level*  $l_i$  to each letter  $w_i$  in a word  $w = w_1w_2 \cdots w_n$  consisting of  $|s|$  copies of the letter N and  $|r|$  copies of the letter E. (Note that  $r$  or  $s$  may be negative.) This assignment is done recursively: use the convention that  $l_0 = 0$ ; for  $i \geq 1$  we set  $l_i = l_{i-1} + r$  if  $w_i = N$  and  $l_i = l_{i-1} + s$  if  $w_i = E$ . The word  $sw_{r,s}(w)$  is then obtained by sorting the letters in  $w$  according to level, starting with  $-1, -2, -3, \dots$ , then continuing with  $\dots, 2, 1, 0$ . Figure 1 provides an example of  $sw_{5,-3}$  acting on the word  $w = ENEENNEE$ . (Here we have identified  $w$  with a lattice path in the plane: each N corresponds to a unit-length north step, while each E corresponds to a unit-length east step.)

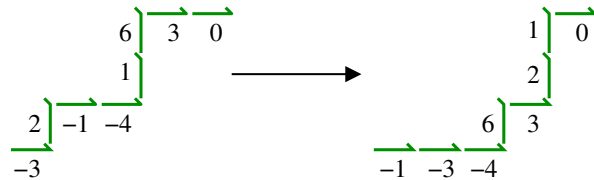

FIGURE 1. The action of the sweep map  $sw_{5,-3}$  on the word  $w = ENEENNEE$ . Next to each step in  $w$  is written its level,  $l_i$ . Each step in  $sw_{5,-3}(w)$  has been labeled by the level of the corresponding step in  $w$ .

Surprisingly, even though sweep maps act by sorting, they are (apparently) bijective. The reader may find it useful to check this bijectivity by hand for  $sw_{3,-2}$  acting on the set of all lattice

---

*Date:* March 24, 2022.

This work was partially supported by a grant from the Simons Foundation (#244398 to Nicholas Loehr).

Third author supported in part by National Science Foundation grant DMS-1201312.

paths from  $(0, 0)$  to  $(3, 2)$ . As detailed in Conjecture 3.3, bijectivity seems to hold even for the general sweep maps over arbitrary alphabets with arbitrary weights, described in Section 3.4. The bijectivity of the general sweep maps appears to be a very subtle and difficult fact.

**Remark 1.1.** The order in which the levels are traversed is a key ingredient to bijectivity. For example, in the case of  $r = 3$ ,  $s = -2$ , if we scan levels in the order  $k = \dots, 2, 1, 0, -1, -2, \dots$ , both of the paths NENEE and NEENE map to NNEEE.

The sweep maps encode complex combinatorial information related to  $q, t$ -Catalan numbers, the Bergeron-Garsia nabla operator, and other constructions arising in representation theory, algebraic geometry, and symmetric functions. Researchers have discovered special cases of the sweep map in many different guises over the last fifteen years or so. One of the goals of this paper is to present a unifying framework for all of this work. In [16, 17, 18], Loehr introduced bijections on  $m$ -Dyck paths, as well as generalizations to lattice paths contained in certain trapezoids, that turn out to be special cases of the sweep map. The bijection in the case  $m = 1$  also appears in a paper of Haglund and Loehr [15] and is foreshadowed by a counting argument in Haglund’s seminal paper on  $q, t$ -Catalan numbers [14, proof of Thm. 3.1]. The inverse bijection in the case  $m = 1$  appears even earlier, where it was used by Andrews et al. [1] in their study of  $ad$ -nilpotent  $\mathfrak{b}$ -ideals in the Lie algebra  $\mathfrak{sl}(n)$ . (See also [21].) More recently, special cases of the sweep map have arisen while studying lattice paths in squares [20]; partition statistics [19]; simultaneous core partitions [2]; and compactified Jacobians [12, 13]. We discuss a number of these connections in more detail in Section 4.

We suspect that to the typical mathematician, the most interesting question regarding the sweep maps is whether they are bijective (as conjectured in Conjecture 3.3). For a researcher interested in the  $q, t$ -Catalan numbers, however, of comparable interest is the connection between the sweep maps and statistics on lattice paths such as **area**, **bounce** and **div**. Since shortly after Haiman’s introduction of **div**, it has been known that a “zeta map” takes **div** to **area** to **bounce**. One point of view, then, is that rather than having three statistics on Dyck paths, we have one statistic — **area** — and a sweep map. Many polynomials related to the  $q, t$ -Catalan numbers can be defined using only an “area” and an appropriate sweep map. That these polynomials are jointly symmetric (conjecturally) supports the utility of this view (see Section 6).

The structure of this paper is as follows. Section 2 introduces the necessary background on lattice paths. We then define sweep maps and present Conjecture 3.3 on their bijectivity in Section 3. Section 4 reviews various algorithms that have appeared in the literature that are equivalent to special cases of the sweep map, while Section 5 describes how to invert these maps (when known). Finally, Section 6 shows how the sweep maps may be used to give concise combinatorial formulas for the higher  $q, t$ -Catalan numbers and related polynomials formed by applying the nabla operator to appropriate symmetric functions and then extracting the coefficient of  $s_{(1^n)}$ .

An extended abstract of this paper appears as [4].

## 2. PARTITIONS, WORDS, AND LATTICE PATHS

This section introduces our basic conventions regarding partitions, words, and lattice paths. Integer parameters  $a$  and  $b$  will serve to restrict our attention to such objects fitting within a rectangle of height  $a$  and width  $b$ . Integer parameters  $r$  and  $s$  will be used to assign a “level” to the components of the various objects considered. Of particular interest is the case of  $r = b$  and  $s = -a$ . The constraint of  $\gcd(a, b) = 1$  arises naturally in some particular sweep maps such as the map due to Armstrong, Hanusa and Jones [2] and the map due to Gorksy and Mazin [12, 13] (see Sections 4.2 and 4.3, respectively).

Let  $a, b \in \mathbb{Z}_{\geq 0}$ . Integer partition diagrams with at most  $a$  parts and largest part at most  $b$  (drawn according to the English convention) fit in the rectangle with vertices  $(0, 0)$ ,  $(b, 0)$ ,  $(0, a)$

and  $(b, a)$ . We denote the set of such partitions (identified with their diagrams, which are collections of unit squares in the first quadrant) by  $\mathcal{R}^{\text{ptn}} = \mathcal{R}^{\text{ptn}}(a, b)$ . Let  $\{N, E\}^*$  denote the set of all words  $w = w_1 w_2 \cdots w_n$ ,  $n \geq 0$ , for which each  $w_j \in \{N, E\}$ , and let  $\mathcal{R}^{\text{word}} = \mathcal{R}^{\text{word}}(N^a E^b)$  denote the subset of words consisting of  $a$  copies of  $N$  and  $b$  copies of  $E$ . Finally, let  $\mathcal{R}^{\text{path}} = \mathcal{R}^{\text{path}}(N^a E^b)$  denote the set of lattice paths from  $(0, 0)$  to  $(b, a)$  consisting of  $a$  unit-length north steps and  $b$  unit-length east steps.

There are natural bijections among the three sets  $\mathcal{R}^{\text{ptn}}$ ,  $\mathcal{R}^{\text{word}}$  and  $\mathcal{R}^{\text{path}}$ . Each word  $w \in \mathcal{R}^{\text{word}}$  encodes a lattice path in  $\mathcal{R}^{\text{path}}$  by letting each  $E$  correspond to an east step and each  $N$  correspond to a north step. The frontier of a partition  $\pi \in \mathcal{R}^{\text{ptn}}$  also naturally encodes a path in  $\mathcal{R}^{\text{path}}$ . We write  $\text{WORD}(P)$  or  $\text{WORD}(\pi)$  for the word associated with a path  $P$  or a partition  $\pi$ , respectively. Operators  $\text{PATH}$  and  $\text{PTN}$  are defined analogously. For example, taking  $a = 3$  and  $b = 5$ , the path  $P$  shown on the left in Figure 1 has  $\text{WORD}(P) = \text{ENEENNEE}$  and  $\text{PTN}(P) = (3, 3, 1)$ . For the word  $w = \text{EEENENNE}$ ,  $\text{PATH}(w)$  is the path shown on the right in Figure 1, whereas  $\text{PTN}(w) = (4, 4, 3)$ .

Let  $r, s \in \mathbb{Z}$ . We assign a **level** to each square of a partition and each step of a path in the following manner. First, assign to each lattice point  $(x, y)$  the  $(r, s)$ -**level**  $ry + sx$ . Assign to each lattice square the level of its southeast corner. We will have occasion to consider two different conventions for associating levels to north and east steps of paths. For the **east-north (E-N)** convention, each east (resp. north) step inherits the level of its eastern (resp. northern) endpoint. For the **west-south (W-S)** convention, each east (resp. north) step inherits the level of its western (resp. southern) endpoint. Figure 2 illustrates the various levels relevant to the word  $\text{NNENE}$  for  $r = 8$  and  $s = -5$ .

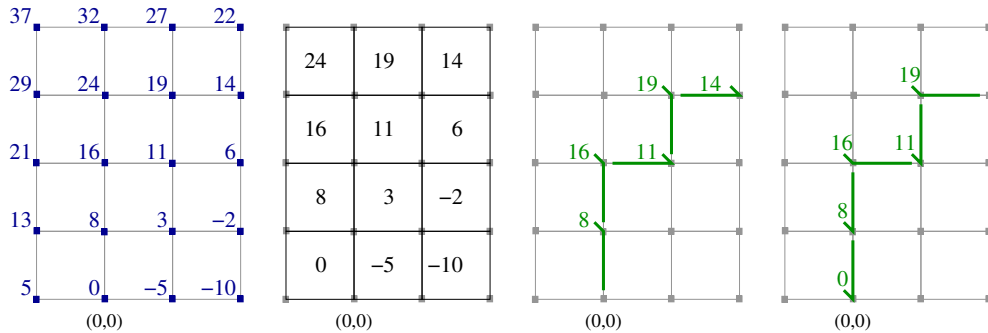

FIGURE 2. Illustration of level-assignment conventions for lattice points, squares, path steps with the east-north convention, and path steps with the west-south convention for the case of  $r = 8$  and  $s = -5$ .

Let  $\mathcal{D}_{r,s}^{\text{path}}(N^a E^b)$  denote the set of lattice paths in  $\mathcal{R}^{\text{path}}(N^a E^b)$  whose steps all have nonnegative  $(r, s)$ -levels under the E-N convention. We call these paths  $(r, s)$ -**Dyck paths**. A word  $w \in \mathcal{R}^{\text{word}}(N^a E^b)$  is an  $(r, s)$ -**Dyck word** iff  $\text{PATH}(w)$  is an  $(r, s)$ -Dyck path; let  $\mathcal{D}_{r,s}^{\text{word}}(N^a E^b)$  denote the set of such words. A partition  $\pi \in \mathcal{R}^{\text{ptn}}(a, b)$  is an  $(r, s)$ -**Dyck partition** iff  $\text{PATH}(\pi)$  is an  $(r, s)$ -Dyck path; let  $\mathcal{D}_{r,s}^{\text{ptn}}(a, b)$  denote the set of such partitions.

### 3. THE SWEEP MAP

We begin in Section 3.1 by giving an algorithmic description of the basic sweep maps for words over the alphabet  $\{N, E\}$ . Some minor variations are presented in Sections 3.2 and 3.3. We then present a general sweep map in Section 3.4 that acts on words over any alphabet with arbitrary weights assigned to each letter.

**3.1. The Basic Sweep Map.** Let  $r, s \in \mathbb{Z}$ . We first describe the  $(r, s)^-$ -sweep map,  $\text{sw}_{r,s}^- : \{\mathbb{N}, \mathbb{E}\}^* \rightarrow \{\mathbb{N}, \mathbb{E}\}^*$ . Given  $w \in \{\mathbb{N}, \mathbb{E}\}^*$ , assign levels using the east-north convention applied to  $\text{PATH}(w)$ . Define a word  $y = \text{sw}_{r,s}^-(w)$  by the following algorithm. Initially,  $y$  is the empty word. For  $k = -1, -2, -3, \dots$  and then for  $k = \dots, 3, 2, 1, 0$ , scan  $w$  from right to left. Whenever a letter  $w_i$  is encountered with level equal to  $k$ , append  $w_i$  to  $y$ . The  $(r, s)^+$ -sweep map  $\text{sw}_{r,s}^+$  is defined the same way as  $\text{sw}_{r,s}^-$ , except that: the value 0 is the first value of  $k$  used rather than the last; and for each value of  $k$ ,  $w$  is scanned from left to right. Figure 3 illustrates the action of both  $\text{sw}_{3,-2}^+$  and  $\text{sw}_{3,-2}^-$  on a path in  $\mathcal{R}^{\text{path}}(\mathbb{N}^8\mathbb{E}^{10})$ . We define the action of  $\text{sw}_{r,s}^-$  on a partition  $\pi$  as  $\text{PTN}(\text{sw}_{r,s}^-(\text{WORD}(\pi)))$  and the action of  $\text{sw}_{r,s}^-$  on a path as  $\text{PATH}(\text{sw}_{r,s}^-(\text{WORD}(P)))$ ; similarly for  $\text{sw}_{r,s}^+$ .

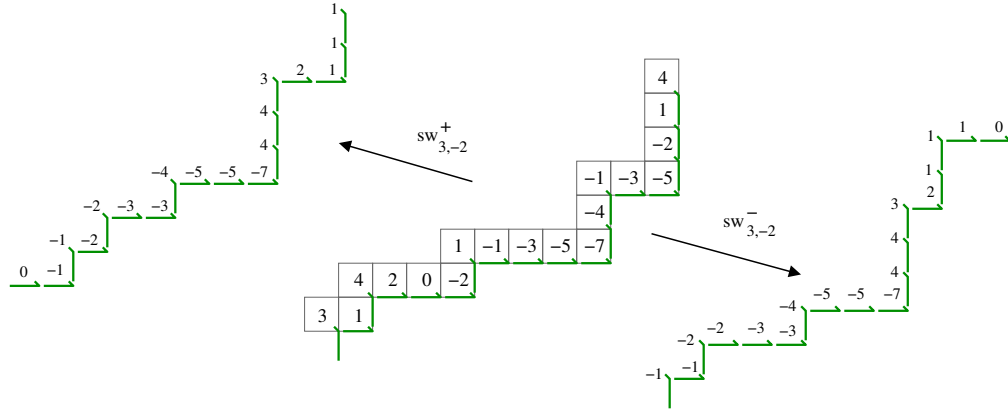

FIGURE 3. Images of  $\text{sw}_{3,-2}^-$  and  $\text{sw}_{3,-2}^+$  acting on a path in  $\mathcal{R}^{\text{path}}(\mathbb{N}^8\mathbb{E}^{10})$ .

Geometrically, we think of each step in  $\text{PATH}(w)$  as a *wand* whose *tip* is located at the lattice point at the end of each step. This visual description reminds us that the maps  $\text{sw}_{r,s}^\pm$  are assigning levels to steps in the path using the east-north convention. For  $r > 0$  and  $s < 0$ ,  $\text{sw}_{r,s}^-$  acts by scanning southwest along each diagonal line  $ry + sx = k$  (taking  $k$ 's in the appropriate order) and “sweeping up” the wands whose tips lie on each of these diagonals. The wands are laid out in the order in which they were swept up to produce the output lattice path. The labels on the wand tips are *not* part of the final output. It is clear from this description, or from the original definition, that the sweep map depends only on the “slope”  $-s/r$ ; i.e.,  $\text{sw}_{r,s}^\pm = \text{sw}_{rm,sm}^\pm$  for every positive integer  $m$ .

**Remark 3.1.** The  $\text{area}_{r,s}^*$  statistic introduced in Section 6.1 is computed using the  $(r, s)$ -levels of the steps in  $w$ , which depend not just on the ratio  $-s/r$  but on the specific values of  $r$  and  $s$ . So it is not always safe to assume that  $r$  and  $s$  are relatively prime.

Since the sweep maps rearrange the letters in the input word  $w$ , it is immediate that both  $\text{sw}_{r,s}^-$  and  $\text{sw}_{r,s}^+$  map each set  $\mathcal{R}^{\text{word}}(\mathbb{N}^a\mathbb{E}^b)$  into itself. We will see later that  $\text{sw}_{r,s}^-$  maps each set  $\mathcal{D}_{r,s}^{\text{word}}(\mathbb{N}^a\mathbb{E}^b)$  into itself.

**3.2. The Irrational-Slope Sweep Map.** So far, for each rational  $-s/r$ , we have defined the basic sweep map  $\text{sw}_{r,s}^-$  (which we also call the **negative-type** sweep map) and the **positive-type** sweep map  $\text{sw}_{r,s}^+$ . We can extend this setup to define sweep maps  $\text{sw}_\beta$  indexed by *irrational* numbers  $\beta$ . We regard inputs to  $\text{sw}_\beta$  as lattice paths  $\text{PATH}(w) \in \mathcal{R}^{\text{path}}(\mathbb{N}^a\mathbb{E}^b)$  consisting of “wands” with tips at their north ends and east ends. There is a “sweep line”  $y - \beta x = k$  that sweeps through the plane as  $k$  decreases from just below zero to negative infinity, then from positive infinity to zero.

Because  $\beta$  is irrational, every sweep line intersects at most one wand tip in  $\text{PATH}(w)$ . We obtain  $\text{sw}_\beta(w)$  by writing the wands in the order in which the sweep line hits the wand tips.

For fixed  $a, b \geq 0$  and fixed  $r > 0, s < 0$ , one readily checks that  $\text{sw}_{r,s}^-(w) = \text{sw}_\beta(w)$  for all irrationals  $\beta$  with  $\beta < -s/r$  and  $\beta$  sufficiently close to  $-s/r$ . On the other hand,  $\text{sw}_{r,s}^+(w) = \text{sw}_\beta(w)$  for all irrationals  $\beta$  with  $\beta > -s/r$  and  $\beta$  sufficiently close to  $-s/r$ . This explains the terminology “positive-type” and “negative-type” sweep map. One approach to studying the sweep map is to understand the “jump discontinuities” between  $\text{sw}_{r,s}^+$  and  $\text{sw}_{r,s}^-$  that occur at certain critical rationals  $-s/r$ .

For irrational  $\beta$ , we say  $w$  is a  $\beta$ -**Dyck word** iff for all lattice points  $(x, y)$  visited by  $\text{PATH}(w)$ ,  $y - \beta x \geq 0$ .

**Proposition 3.2.** (a) For all irrational  $\beta$ , if  $w \in \{\text{N}, \text{E}\}^*$  is a  $\beta$ -Dyck word then  $v = \text{sw}_\beta(w)$  is a  $\beta$ -Dyck word. (b) For all  $r, s \in \mathbb{Z}$ , if  $w \in \{\text{N}, \text{E}\}^*$  is an  $(r, s)$ -Dyck word, then  $v = \text{sw}_{r,s}^-(w)$  is an  $(r, s)$ -Dyck word.

*Proof.* (a) If  $\beta < 0$  then all words are  $\beta$ -Dyck words, so the proposition certainly holds. Therefore, in the following we assume  $\beta > 0$ . Fix  $j > 0$ ; it suffices to show that the point  $(x, y)$  reached by the first  $j$  steps of  $\text{PATH}(v)$  satisfies  $y > \beta x$ . Since  $\beta$  is irrational and  $w$  is a  $\beta$ -Dyck word, there exists a real  $k > 0$  such that  $v_1 \cdots v_j$  consists of all the symbols in  $w$  with wand tips at levels higher than  $k$ . In other words,  $v_1 \cdots v_j$  is a rearrangement of all the steps of  $\text{PATH}(w)$  that end at points  $(x, y)$  with  $y > \beta x + k$ . Now,  $\text{PATH}(w)$  begins at the origin, which has level zero. In general, this path enters and leaves the region  $R_k = \{(x, y) : y > \beta x + k\}$  several times. Let  $w^{(1)}, \dots, w^{(t)}$  be the maximal substrings of consecutive letters in  $w$  such that every step of  $w^{(i)}$  ends in  $R_k$ . Every  $w^{(i)}$  begins with a north step that enters  $R_k$  from below, and every  $w^{(i)}$  except possibly  $w^{(t)}$  is followed by an east step that exits  $R_k$  to the right. Suppose  $w^{(i)}$  consists of  $a_i$  north steps and  $b_i$  east steps; since the boundary of  $R_k$  is a line of slope  $\beta$ , the geometric fact in the previous sentence implies that  $a_i/b_i > \beta$  for  $1 \leq i \leq t$ . By definition,  $v_1 \cdots v_j$  is some rearrangement of  $a = a_1 + \cdots + a_t$  north steps and  $b = b_1 + \cdots + b_t$  east steps. Now  $a_i > \beta b_i$  for all  $i$  implies  $a > \beta b$ . Thus,  $v_1 \cdots v_j$  is a path from  $(0, 0)$  to  $(b, a)$ , where  $a > \beta b$ . Since  $j$  was arbitrary,  $\text{PATH}(v)$  is a  $\beta$ -Dyck path.

(b) It suffices to treat the case  $r > 0, s < 0$ . Fix  $a, b \geq 0$  and  $w \in \mathcal{D}_{r,s}^{\text{word}}(\text{N}^a \text{E}^b)$ . We can choose an irrational  $\beta < -s/r$  so close to  $-s/r$  that the region  $S = \{(x, y) \in \mathbb{R}^2 : \beta x \leq y < (-s/r)x, y \leq a\}$  contains no lattice points, and  $v = \text{sw}_\beta(w) = \text{sw}_{r,s}^-(w)$ . Since  $w$  is an  $(r, s)$ -Dyck word and  $\beta < -s/r$ ,  $w$  is also a  $\beta$ -Dyck word. By part (a),  $v = \text{sw}_\beta(w)$  is a  $\beta$ -Dyck word. Since  $S$  contains no lattice points,  $v$  is an  $(r, s)$ -Dyck word, as needed. □

**3.3. Reversed and Transposed Sweeps.** For a fixed choice of  $r$  and  $s$ , there are four parameters that can be used to define a potential sweep map:

- the level to start sweeping at,
- the direction of sweep for a given level (i.e., right-to-left or left-to-right),
- the relative order in which to visit levels (i.e.,  $k + 1$  after level  $k$  versus  $k - 1$  after level  $k$ ),
- the convention for levels assigned to steps (i.e., using the west-south convention or the east-north convention).

Empirical evidence suggests that for each of the  $8 = 2^3$  possible choices for the second through fourth parameters, there is a unique choice of starting level that will lead to a bijective sweep map for general  $\mathcal{R}^{\text{path}}(\text{N}^a \text{E}^b)$ . In fact, each of these maps is closely related to the others through the following two natural involutions on words. Let  $\text{rev} : \{\text{N}, \text{E}\}^* \rightarrow \{\text{N}, \text{E}\}^*$  be the **reversal map** given by  $\text{rev}(w_1 w_2 \cdots w_n) = w_n \cdots w_2 w_1$ . Let  $\text{flip} : \{\text{N}, \text{E}\}^* \rightarrow \{\text{N}, \text{E}\}^*$  be the **transposition map** that acts by interchanging N’s and E’s. Evidently, both  $\text{rev}$  and  $\text{flip}$  are involutions;  $\text{rev}$  maps  $\mathcal{R}^{\text{path}}(\text{N}^a \text{E}^b)$  bijectively onto itself, whereas  $\text{flip}$  maps  $\mathcal{R}^{\text{path}}(\text{N}^a \text{E}^b)$  bijectively onto  $\mathcal{R}^{\text{path}}(\text{N}^b \text{E}^a)$ .

We can modify the sweep maps by composing on the left or right with **rev** and/or **flip**. The new maps are bijections (between appropriate domains and codomains) iff the original sweep maps are bijections. Table 1 displays the eight maps along with their relationships to  $\text{sw}_{r,s}^-$  and  $\text{sw}_{r,s}^+$ . One can also check that

$$\text{rev} \circ \text{sw}_{-r,-s}^+ = \text{sw}_{r,s}^- \quad \text{and} \quad \text{flip} \circ \text{sw}_{s,r}^- \circ \text{flip} = \text{sw}_{r,s}^-.$$

The following degenerate cases of the sweep map are readily verified.

- If  $r < 0$  and  $s < 0$ , then  $\text{sw}_{r,s}^\pm = \text{id}$ , the identity map on  $\{\mathbf{N}, \mathbf{E}\}^*$ .
- If  $r > 0$  and  $s > 0$ , then  $\text{sw}_{r,s}^\pm = \text{rev}$ , the reversal map.
- For  $r = s = 0$ ,  $\text{sw}_{0,0}^- = \text{rev}$  and  $\text{sw}_{0,0}^+ = \text{id}$ .
- If  $r = 0$  and  $s < 0$ , then  $\text{sw}_{r,s}^+ = \text{id}$ , whereas  $\text{sw}_{r,s}^-$  maps  $\mathbf{N}^{a_0} \mathbf{E} \mathbf{N}^{a_1} \mathbf{E} \mathbf{N}^{a_2} \dots \mathbf{E} \mathbf{N}^{a_k}$  (where  $a_j \geq 0$ ) to  $\mathbf{N}^{a_1} \mathbf{E} \mathbf{N}^{a_2} \mathbf{E} \dots \mathbf{N}^{a_k} \mathbf{E} \mathbf{N}^{a_0}$ . Similar statements hold in the cases:  $r = 0$  and  $s > 0$ ;  $s = 0$  and  $r < 0$ ;  $s = 0$  and  $r > 0$ .

TABLE 1. Symmetries of sweep maps.

Map	Step-labeling convention	Order to scan levels	Sweep direction on each level	Start level
$\text{sw}_{r,s}^-$	E-N	decreasing	$\leftarrow$	$-1$
$\text{sw}_{r,s}^+$	E-N	decreasing	$\rightarrow$	$0$
$\text{rev} \circ \text{sw}_{r,s}^-$	E-N	increasing	$\rightarrow$	$0$
$\text{rev} \circ \text{sw}_{r,s}^+$	E-N	increasing	$\leftarrow$	$1$
$\text{sw}_{r,s}^- \circ \text{rev}$	W-S	increasing	$\rightarrow$	$ra + sb + 1$
$\text{sw}_{r,s}^+ \circ \text{rev}$	W-S	increasing	$\leftarrow$	$ra + sb$
$\text{rev} \circ \text{sw}_{r,s}^- \circ \text{rev}$	W-S	decreasing	$\leftarrow$	$ra + sb$
$\text{rev} \circ \text{sw}_{r,s}^+ \circ \text{rev}$	W-S	decreasing	$\rightarrow$	$ra + sb - 1$

**3.4. The General Sweep Map.** Suppose  $A = \{x_1, \dots, x_k\}$  is a given alphabet and  $\text{wt} : A \rightarrow \mathbb{Z}$  is a function assigning an integer **weight** to each letter in  $A$ . Given a word  $w = w_1 w_2 \dots w_n \in A^*$ , define the *levels*  $l_0, \dots, l_n$  relative to the weight function  $\text{wt}$  by setting  $l_0 = 0$  and, for  $1 \leq i \leq n$ , letting  $l_i = l_{i-1} + \text{wt}(w_i)$ . (These levels are essentially computed according to the east-north convention, though the west-south convention works equally well.) Define  $\text{sw}_{\text{wt}} : A^* \rightarrow A^*$  as follows: For each  $k$  from  $-1$  down to  $-\infty$  and then from  $\infty$  down to  $0$ , scan  $w$  from right to left, writing down each  $w_i$  with  $l_i = k$  and  $i > 0$ . Let  $\mathcal{R}^{\text{word}}(x_1^{n_1} \dots x_k^{n_k})$  be the set of words  $w \in A^*$  consisting of  $n_j$  copies of  $j$  for  $1 \leq j \leq k$ . Let  $\mathcal{D}_{\text{wt}}^{\text{word}}(x_1^{n_1} \dots x_k^{n_k})$  be the set of such words for which all levels  $l_i$  are nonnegative.

**Conjecture 3.3.** *Let  $A = \{x_1, \dots, x_k\}$  be an alphabet and  $\text{wt} : A \rightarrow \mathbb{Z}$  a weight function. For any nonnegative integers  $n_1, n_2, \dots, n_k$ ,*

- $\text{sw}_{\text{wt}}$  maps  $\mathcal{R}^{\text{word}}(x_1^{n_1} \dots x_k^{n_k})$  bijectively to itself.
- $\text{sw}_{\text{wt}}$  maps  $\mathcal{D}_{\text{wt}}^{\text{word}}(x_1^{n_1} \dots x_k^{n_k})$  bijectively to itself.

#### 4. ALGORITHMS EQUIVALENT TO A SWEEP MAP

This section reviews some algorithms that have appeared in the literature that are equivalent to special cases of the sweep map and its variations. We describe each algorithm and indicate its exact relation to the general sweep map. The algorithms reviewed here fall into three main classes: algorithms that operate on area vectors, algorithms that operate on hook-lengths of cells in a partition, and algorithms involving generators of certain semi-modules. The algorithms based

on area vectors arose in the study of the  $q, t$ -Catalan polynomials and their generalizations; these polynomials will be discussed at greater length later in this paper. The algorithms involving hook-lengths and semi-modules were introduced to study the special case of Dyck objects where the dimensions  $a$  and  $b$  are coprime. The sweep map provides a single unifying framework that simultaneously generalizes all these previously studied algorithms. We find it remarkable that this map, which has such a simple definition, encodes such a rich array of mathematical structures.

#### 4.1. Algorithms Based on Area Vectors.

4.1.1. *Introduction.* This subsection studies several algorithms that operate on lattice paths by manipulating an *area vector* that records how many area cells in each row lie between the path and a diagonal boundary. The simplest version of these algorithms is a bijection on Dyck paths described in a paper by Haglund and Loehr [15, §3, Bijections]. In [16, 17, 18], Loehr generalized this bijection to define a family of maps  $\phi$  acting on  $m$ -Dyck paths and on lattice paths contained in certain trapezoids. We begin our discussion with the maps for trapezoidal lattice paths, which contain the earlier maps as special cases. We then look at a generalization of  $\phi$  acting on lattice paths inside squares, followed by a different variation that acts on Schröder paths containing diagonal steps.

4.1.2. *Trapezoidal Lattice Paths.* Fix integers  $k \geq 0$  and  $n, m > 0$ . Let  $T_{n,k,m}$  denote the set of *trapezoidal lattice paths* from  $(0, 0)$  to  $(k + mn, n)$  that never go strictly to the right of the line  $x = k + my$ . The paper [18] introduces a bijection  $\phi = \phi_{n,k,m} : T_{n,k,m} \rightarrow T_{n,k,m}$  and its inverse. That paper (last paragraph of Section 3.1) accidentally switches the roles of  $\phi$  and  $\phi^{-1}$  compared to [16] and other literature. The map  $\phi_{n,k,m}$  discussed below is the composite  $\alpha^{-1} \circ \beta \circ \gamma$  from [18] (which is erroneously denoted  $\phi^{-1}$  in that paper). After recalling the definition of this map, we show that a variant of  $\phi_{n,k,m}$  is a sweep map.

Given a path  $P \in T_{n,k,m}$ , we first construct the **area vector**  $g(P) = (g_0, g_1, \dots, g_{n-1})$ , where  $g_i$  is the number of complete lattice squares in the horizontal strip  $\{(x, y) : x \geq 0, i \leq y \leq i + 1\}$  that lie to the right of  $P$  and to the left of the line  $x = k + my$ . The area vector  $g(P)$  has the following properties:  $0 \leq g_0 \leq k$ ;  $g_i$  is a nonnegative integer for  $0 \leq i < n$ ; and  $g_i \leq g_{i-1} + m$  for  $1 \leq i < n$ . One readily checks that  $P \mapsto g(P)$  is a bijection from  $T_{n,k,m}$  to the set of vectors of length  $n$  with the properties just stated.

For  $P \in T_{n,k,m}$ , we compute  $\phi(P)$  by concatenating lattice paths (regarded as words in  $\{N, E\}^*$ ) that are built up from subwords of  $g(P)$  as follows. For  $i = 0, 1, 2, \dots$ , let  $z^{(i)}$  be the subword of  $g(P)$  consisting of symbols in the set  $\{i, i - 1, i - 2, \dots, i - m\}$ ; let  $M$  be the largest  $i$  such that  $z^{(i)}$  is nonempty. Create a word  $\sigma^{(i)} \in \{N, E\}^*$  from  $z^{(i)}$  by replacing each symbol  $i$  in  $z^{(i)}$  by  $N$  and replacing all other symbols in  $z^{(i)}$  by  $E$ . Let  $\sigma$  be the concatenation of words

$$\sigma = \sigma^{(0)} E\sigma^{(1)} E\sigma^{(2)} \dots E\sigma^{(k)} \sigma^{(k+1)} \dots \sigma^{(M)},$$

in which an extra east step is added after the first  $k$  words. Define  $\phi(P) = \text{PATH}(\sigma)$ . It is proved in [18, Sec. 3] that  $\phi(P)$  always lies in  $T_{n,k,m}$ , and that  $\phi_{n,k,m}$  is a bijection.

To relate  $\phi$  to the sweep map, we need to introduce a modified map  $\phi'$  that incorporates the bijection described in [18, Sec. 4]. Keep the notation of the previous paragraph. For all  $i$  with  $k < i \leq M$ , note that  $\sigma^{(i)}$  must begin with an  $E$ , so we can write  $\sigma^{(i)} = E\tilde{\sigma}^{(i)}$ . Let  $\tau^{(i)} = \text{rev}(\sigma^{(i)})$  for  $0 \leq i \leq k$ , and let  $\tau^{(i)} = E \text{rev}(\tilde{\sigma}^{(i)})$  for  $k < i \leq M$ . Define  $\phi'(P) = \text{PATH}(\tau)$ , where

$$\tau = \tau^{(0)} E\tau^{(1)} E\tau^{(2)} \dots E\tau^{(k)} \tau^{(k+1)} \dots \tau^{(M)}.$$

**Example 4.1.** Let  $n = 8, k = 2, m = 2$ , and  $\text{WORD}(P) = \text{ENNEENEEEEENNEEENNEEENEEEE}$ . Then  $g(P) = (1, 3, 3, 0, 2, 1, 3, 2)$ , so

$$\begin{aligned} z^{(0)} &= 0, & z^{(1)} &= 101, & z^{(2)} &= 10212, & z^{(3)} &= 1332132, & z^{(4)} &= 33232, & z^{(5)} &= 333, \\ \sigma^{(0)} &= \text{N}, & \sigma^{(1)} &= \text{NEN}, & \sigma^{(2)} &= \text{EENEN}, & \sigma^{(3)} &= \text{ENNEENE}, & \sigma^{(4)} &= \text{EEEEEE}, & \sigma^{(5)} &= \text{EEE}, \\ \tau^{(0)} &= \text{N}, & \tau^{(1)} &= \text{NEN}, & \tau^{(2)} &= \text{NENEE}, & \tau^{(3)} &= \text{EENEENN}, & \tau^{(4)} &= \text{EEEEEE}, & \tau^{(5)} &= \text{EEE}, \end{aligned}$$

$$\begin{aligned} \text{WORD}(\phi(P)) &= \sigma = \text{N ENEN EEENEN ENNEENE EEEEE EEE}, \\ \text{WORD}(\phi'(P)) &= \tau = \text{N ENEN ENENEE EENEENN EEEEE EEE}. \end{aligned}$$

**Theorem 4.2.** For all  $k \geq 0, n, m > 0$ , and  $P \in T_{n,k,m}$ ,

$$\text{WORD}(\phi'_{n,k,m}(P)) = \text{flip} \circ \text{rev} \circ \text{sw}_{1,-m}^- \circ \text{rev} \circ \text{flip}(\text{WORD}(P)).$$

*Proof. Step 1.* Write  $w = \text{WORD}(P) = w_1 w_2 \cdots w_{k+n+nm}$  and  $\text{sw}' = \text{flip} \circ \text{rev} \circ \text{sw}_{1,-m}^- \circ \text{rev} \circ \text{flip}$ . One may routinely check that  $\text{sw}'(w)$  may be computed by the following algorithm. Let  $l_1 = k$ ,  $l_{j+1} = l_j + m$  if  $w_j = \text{N}$ , and  $l_{j+1} = l_j - 1$  if  $w_j = \text{E}$ . (Thus in this variation, a north step  $w_j$  from  $(x, y)$  to  $(x, y + 1)$  has associated level  $l_j = k + my - x \geq 0$ , whereas an east step  $w_j$  from  $(x, y)$  to  $(x + 1, y)$  has associated level  $l_j = k + my - x > 0$ . Up to the shift by  $k$ , this is the west-south convention for assigning levels.) Generate an output word  $y$  from left to right as follows. For each level  $L = 0, 1, 2, \dots$ , scan  $w$  from right to left, and append the letter  $w_j$  to the right end of  $y$  whenever an index  $j \leq k + n + nm$  is scanned for which  $l_j = L$ . For each  $i \geq 0$ , let  $\rho^{(i)}$  be the subword of  $y$  generated in the  $L = i$  iteration of the algorithm.

In the preceding example, the sequence of steps and levels is

$$\begin{aligned} &\text{ENNEENEEEEENNEEENNEEENEEEE} \\ &2\ 1\ 3\ 5\ 4\ 3\ 5\ 4\ 3\ 2\ 1\ 0\ 2\ 4\ 3\ 2\ 1\ 3\ 5\ 4\ 3\ 2\ 4\ 3\ 2\ 1\ (0), \end{aligned}$$

where the zero in parentheses is the level following the final east step. The subwords  $\rho^{(i)}$  are

$$\rho^{(0)} = \text{N}, \rho^{(1)} = \text{ENEN}, \rho^{(2)} = \text{ENENEE}, \rho^{(3)} = \text{EENEENN}, \rho^{(4)} = \text{EEEEEE}, \rho^{(5)} = \text{EEE}.$$

By definition of the levels, one sees that the maximum level of any letter in  $w$  is the same value  $M$  appearing in the definition of  $\phi'(P)$ . Since  $y = \text{sw}'(w) = \rho^{(0)}\rho^{(1)}\cdots\rho^{(M)}$ , it will suffice to prove that  $\rho^{(0)} = \tau^{(0)}$ ,  $\rho^{(i)} = \text{E}\tau^{(i)}$  for  $1 \leq i \leq k$ , and  $\rho^{(i)} = \tau^{(i)}$  for all  $i$  with  $k < i \leq M$  (as illustrated by Example 4.1). Define  $\tilde{\rho}^{(i)} = \text{rev}(\rho^{(i)})$  for all  $i$ ; this is the word obtained by scanning  $w$  from left to right and taking all letters at level  $i$ . By reversing everything, it is enough to prove that  $\tilde{\rho}^{(0)} = \sigma^{(0)}$ ,  $\tilde{\rho}^{(i)} = \sigma^{(i)}\text{E}$  for  $1 \leq i \leq k$ , and  $\tilde{\rho}^{(i)} = \tilde{\sigma}^{(i)}\text{E}$  for all  $i$  with  $k < i \leq M$ .

**Step 2.** Fix a level  $L = i$ . We define an **event sequence** in  $\{\text{A}, \text{B}, \text{C}\}^*$  associated with a left-to-right scan of level  $i$ . It follows from Step 1 that the levels of the north steps of  $P$  will be  $g_0, g_1, \dots, g_{n-1}$  in this order. As we scan  $w$  during this iteration, the following **events** may occur:

- A. We scan an N of  $w$  at level  $i$ , which appends an N onto both  $\sigma^{(i)}$  and  $\tilde{\rho}^{(i)}$ .
- B. We scan an E of  $w$  at level  $i$ , which appends an E onto  $\tilde{\rho}^{(i)}$ .
- C. We scan an N of  $w$  with level in  $\{i - 1, i - 2, \dots, i - m\}$ , which appends an E onto  $\sigma^{(i)}$ .

Consider the sequence of events A, B, C that occur during the  $L = i$  scan. In our example, the  $L = 2$  scan has event sequence BCBCABCAB, whereas the  $L = 3$  scan has event sequence CAABCBCABC.

**Step 3.** We prove that  $\tilde{\rho}^{(0)} = \sigma^{(0)}$ . For the  $L = 0$  scan, events B and C are impossible, since the path stays within the trapezoid. So the event sequence consists of  $j$  A's for some  $j$ , and  $\tilde{\rho}^{(0)}$  and  $\sigma^{(0)}$  both consist of  $j$  N's.



**Step 4.** For  $0 < i \leq M$ , we analyze the possible transitions between events A, B, and C that may occur during the  $L = i$  scan. Note that events A and B can only occur when the level of the current character in  $w$  is  $\geq i$ , whereas event C only occurs when this level is  $< i$ . Moreover, the only way to transition from a level  $\geq i$  to a level  $< i$  is via event B, and the only way to transition from a level  $< i$  to a level  $\geq i$  is via event C. Consequently, in the event sequence for  $L = i$ , every A (not at the end) can only be followed by A or B; every B (not at the end) can only be followed by C; and every C (not at the end) can only be followed by A or B. The path  $P$  ends at level  $0 < i$ , so the event sequence must end in a B.

**Step 5.** We prove that  $\tilde{\rho}^{(i)} = \sigma^{(i)}E$  for  $1 \leq i \leq k$ . Since  $i \leq k$  and the origin has level  $k$ , the first letter in the event sequence must be A or B. By Step 4, the event sequence is some rearrangement of A's and BC's, except there is an unmatched B at the end. By definition of the events in Step 2, this means that  $\tilde{\rho}^{(i)}$  and  $\sigma^{(i)}$  agree, except for an extra E at the end of  $\tilde{\rho}^{(i)}$ .

**Step 6.** We prove that  $\tilde{\rho}^{(i)} = \tilde{\sigma}^{(i)}E$  for  $k < i \leq M$ . Since  $i > k$  and the origin has level  $k$ , the first letter in the event sequence must be an unmatched C. Thereafter, the event sequence consists of A's and matched BC pairs, with one unmatched B at the end. The initial C gives the initial E in  $\sigma^{(i)}$  that is deleted to form  $\tilde{\sigma}^{(i)}$ . As in Step 5, we see that  $\tilde{\rho}^{(i)}$  and  $\tilde{\sigma}^{(i)}$  agree, except for an extra E at the end of  $\tilde{\rho}^{(i)}$  caused by the unmatched B.  $\square$

The proof structure above can be readily adapted to show that other algorithms based on area vectors are equivalent to suitable sweep maps. For this reason, we will omit the details of these proofs in the remainder of this subsection. For instance, one can modify the preceding proof to show that the map  $\phi_{n,0,1}$  (which acts on Dyck paths of order  $n$ ) is also a sweep map.

**Theorem 4.3.** For all  $n > 0$  and  $P \in T_{n,0,1}$ ,  $\text{WORD}(\phi_{n,0,1}(P)) = \text{flip} \circ \text{rev} \circ \text{sw}_{1,-1}^-(\text{WORD}(P))$ .

Similarly, let  $\phi_{\text{HL}}$  denote the map described in [15, §3, Bijections] that sends unlabeled Dyck paths to unlabeled Dyck paths.

**Theorem 4.4.** For all  $n > 0$  and  $P \in T_{n,0,1}$ ,  $\text{WORD}(\phi_{\text{HL}}(P)) = \text{sw}_{1,-1}^-(\text{WORD}(P))$ .

We note that the partition  $\text{PTN}(\phi_{n,0,1}(P))$  is the transpose of the partition  $\text{PTN}(\phi_{\text{HL}}(P))$ . Since

$$\text{flip} \circ \text{rev}(\text{WORD}(\pi)) = \text{WORD}(\pi')$$

for all partitions  $\pi$  (where  $\pi'$  denotes the transpose of  $\pi$ ), the theorem for  $\phi_{\text{HL}}$  follows from the theorem for  $\phi_{n,0,1}$  and vice versa.

**4.1.3. Square Lattice Paths.** In [20], Loehr and Warrington modified the map  $\phi_{\text{HL}}$  to obtain a bijection  $\phi_{\text{LW}}$  on  $\mathcal{R}^{\text{path}}(\mathbb{N}^n \mathbb{E}^n)$ , the set of lattice paths in an  $n \times n$  square. Given  $P \in \mathcal{R}^{\text{path}}(\mathbb{N}^n \mathbb{E}^n)$ , we define its **area vector**  $g(P) = (g_0, g_1, \dots, g_{n-1})$  by letting  $g_i + n - i$  be the number of complete squares in the strip  $\{(x, y) : x \geq 0, i \leq y \leq i + 1\}$  that lie to the right of  $P$  and to the left of  $x = n$ . (This reduces to the previous area vector if  $P$  is a Dyck path.) The area vectors of paths in  $\mathcal{R}^{\text{path}}(\mathbb{N}^n \mathbb{E}^n)$  are characterized by the following properties:  $g_0 \leq 0$ ;  $g_i + n - i \geq 0$  for  $0 \leq i < n$ ; and  $g_i \leq g_{i-1} + 1$  for  $1 \leq i < n$ .

Given  $P \in \mathcal{R}^{\text{path}}(\mathbb{N}^n \mathbb{E}^n)$ , we define a new path  $\phi_{\text{LW}}(P)$  as follows. For all  $i \in \mathbb{Z}$ , let  $z^{(i)}$  be the subword of  $g(P)$  consisting of all occurrences of  $i$  and  $i - 1$ . Create words  $\sigma^{(i)}$  from  $z^{(i)}$  by replacing each  $i$  by E and each  $i - 1$  by N. For all  $i \geq 0$ , let  $\tau^{(i)}$  be the reversal of  $\sigma^{(i)}$ . For all  $i < 0$ ,  $\sigma^{(i)}$  must end in E, so we can write  $\sigma^{(i)} = \tilde{\sigma}^{(i)}E$ ; let  $\tau^{(i)} = \text{rev}(\tilde{\sigma}^{(i)})E$ . Finally, define

$$\tau = \tau^{(-1)}\tau^{(-2)} \dots \tau^{(-n)}\tau^{(n)} \dots \tau^{(2)}\tau^{(1)}\tau^{(0)},$$

and set  $\phi_{\text{LW}}(P) = \text{PATH}(\tau)$ .

**Example 4.5.** Let  $P \in \mathcal{R}^{\text{path}}(\mathbb{N}^{16}\mathbb{E}^{16})$  be such that

$$\text{WORD}(P) = w = \text{ENEENENNNNEENEEEEENNENEENNENEENNEE}.$$

Then  $g(P) = (-1, -2, -2, -1, 0, 1, 0, -3, -2, -1, -1, -2, -1, 0, 1, 1)$ , so (for instance)  $z^{(1)} = 010011$ ,  $\sigma^{(1)} = \text{NENNEE}$ ,  $\tau^{(1)} = \text{EENNEN}$ ,  $z^{(-2)} = -2 -2 -3 -2 -2$ ,  $\sigma^{(-2)} = \text{EENEE}$ ,  $\tau^{(-2)} = \text{ENEEEE}$ , and so on. Next,  $\tau$  is the concatenation of the words  $\tau^{(-1)} = \text{NEENENNEE}$ ,  $\tau^{(-2)} = \text{ENEEEE}$ ,  $\tau^{(-3)} = \text{E}$ ,  $\tau^{(2)} = \text{NNN}$ ,  $\tau^{(1)} = \text{EENNEN}$ , and  $\tau^{(0)} = \text{ENNNEENN}$ , and  $\phi_{\text{LW}}(P) = \text{PATH}(\tau)$ . On the other hand, the reader can check that  $\tau = \text{sw}_{1,-1}^-(w)$ . In fact, for all  $i \in \mathbb{Z}$ , the subword  $\tau^{(i)}$  is precisely the subword  $\rho^{(i)}$  of letters in  $\text{sw}_{1,-1}^-(w)$  coming from letters in  $w$  with  $(1, -1)$ -level (using the E-N convention) equal to  $i$ . One can prove this always happens, by adapting the ideas in the proof of Theorem 4.2, to obtain the following theorem.

**Theorem 4.6.** For all  $n > 0$  and all  $P \in \mathcal{R}^{\text{path}}(\mathbb{N}^n\mathbb{E}^n)$ ,  $\text{WORD}(\phi_{\text{LW}}(P)) = \text{sw}_{1,-1}^-(\text{WORD}(P))$ .

4.1.4. *Schröder Lattice Paths.* A **Schröder path** of order  $n$  is a path from the origin  $(0, 0)$  to  $(n, n)$ , never going below  $y = x$ , with the allowed steps being north steps of length 1, east steps of length 1, and a northeast step of length  $\sqrt{2}$ . In [9, Theorem 6], Egge, Haglund, Killpatrick, and Kremer extend  $\phi_{\text{HL}}$  to a bijection  $\phi_{\text{EHKK}}$  acting on Schröder paths.

**Theorem 4.7.** After converting from paths to words,  $\phi_{\text{EHKK}}$  is the sweep map  $\text{sw}_{\text{wt}}$  associated to the alphabet  $A = \{\mathbb{N}, \mathbb{D}, \mathbb{E}\}$  with weight function  $\text{wt}(\mathbb{N}) = 1$ ,  $\text{wt}(\mathbb{D}) = 0$ , and  $\text{wt}(\mathbb{E}) = -1$ .

4.2. **An Algorithm Based on Hook-Lengths.** Throughout this subsection, fix positive integers  $a$  and  $b$  with  $\gcd(a, b) = 1$ . In [2], D. Armstrong, C. Hanusa and B. Jones investigate the combinatorics of  $(a, b)$ -cores. In the process, they define a map  $\text{zeta} : \mathcal{D}_{b,-a}^{\text{ptn}}(a, b) \rightarrow \mathcal{D}_{b,-a}^{\text{ptn}}(a, b)$ . For  $\pi \in \mathcal{D}_{b,-a}^{\text{ptn}}(a, b)$ , the partition  $\text{zeta}(\pi)$  is defined in two stages. First, create a partition  $\nu = f(\pi)$  as follows. Consider the levels of all lattice squares lying above  $by = ax$  and below the path  $\text{PATH}(\pi)$ . Since  $\gcd(a, b) = 1$ , these levels must all be distinct. Sort these levels into increasing order, and write them in a column from bottom to top. Let  $\nu = f(\pi)$  be the unique partition such that these levels are the hook-lengths of the cells in the first column. (Recall that the **hook** of a cell  $c$  in a partition diagram consists of  $c$  itself, all cells below  $c$  in its column, and all cells right of  $c$  in its row. The **hook-length** of  $c$ , denoted  $h(c)$ , is the number of cells in the hook of  $c$ .)

The second stage maps  $\nu$  to a new partition  $\rho = g(\nu)$  as follows. There will be one nonzero row of  $\rho$  for each row of  $\nu$  whose first-column hook-length is the level of a square directly east of a north step of  $\text{PATH}(\pi)$ . To determine the length of each row in  $\rho$ , count the number of cells of  $\nu$  in the corresponding row whose hook-length is less than or equal to  $b$ . The  $\text{zeta}$  map is then defined by  $\text{zeta}(\pi) = g \circ f(\pi)$ . See Figure 4 for an example.

**Theorem 4.8.** For all  $\pi \in \mathcal{D}_{b,-a}^{\text{ptn}}(a, b)$ ,  $\text{WORD}(\text{zeta}(\pi)) = \text{sw}_{b,-a}^+ \circ \text{rev}(\text{WORD}(\pi))$ .

To prove this theorem, we will introduce alternate formulations of the maps  $f$  and  $g$ , denoted  $\tilde{f}$  and  $\tilde{g}$ , that focus attention on the lattice paths making up the frontiers of  $\pi$ ,  $\nu$ , and  $\rho$ . This will enable us to compare the action of the  $\text{zeta}$  map on partitions to the action of the sweep map on lattice paths. To start, define  $\tilde{f} : \mathcal{D}^{\text{ptn}} \rightarrow \mathcal{R}^{\text{ptn}}$  by setting  $\tilde{f}(\pi) = \text{PTN}(z_0 z_1 z_2 \cdots)$ , where  $z_0 = \mathbb{E}$ , and for all  $i > 0$ ,

$$z_i = \begin{cases} \mathbb{N}, & \text{if the square with level } i \text{ lies between } \text{PATH}(\pi) \text{ and the line } by = ax, \\ \mathbb{E}, & \text{otherwise.} \end{cases}$$

Since  $\text{PATH}(\pi)$  begins at  $(0, 0)$  and ends at  $(b, a)$ , we must have  $z_i = \mathbb{E}$  for all  $i > ab - a - b$ .

**Lemma 4.9.** For all  $\pi \in \mathcal{D}^{\text{ptn}}$ ,  $\tilde{f}(\pi) = f(\pi)$ .

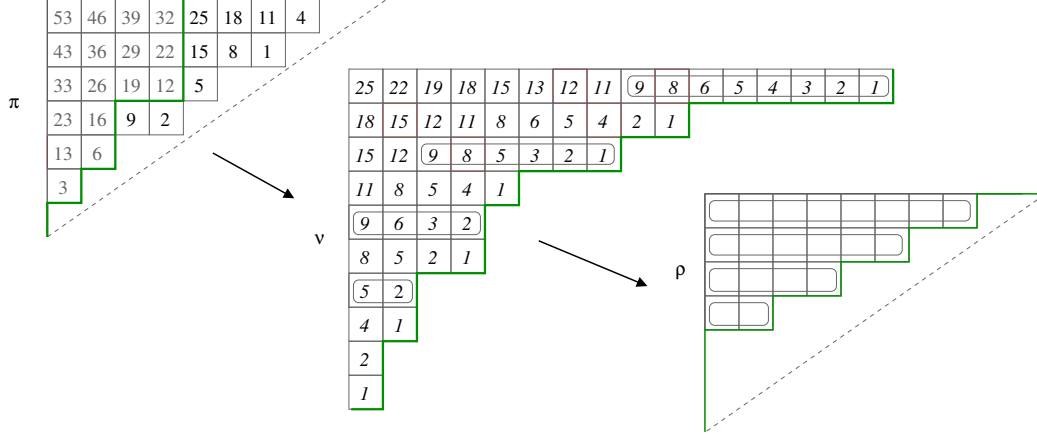

FIGURE 4. Example of the zeta map applied to  $\pi = (4, 4, 4, 2, 2, 1)$  for  $a = 7$  and  $b = 10$ . The partitions  $\nu = f(\pi)$  and  $\rho = g(\nu) = \mathbf{zeta}(\pi) = (8, 6, 4, 2)$  are shown. Each cell of  $\nu$  is labeled with its hook-length.

*Proof.* We first observe that the partitions  $\tilde{f}(\pi)$  and  $f(\pi)$  will have the same number of (positive-length) rows. For, on one hand, the first-column hook-lengths in  $f(\pi)$  will be the levels of the squares between  $\text{PATH}(\pi)$  and  $by = ax$ . On the other hand, these same levels will be the indices of the north steps of  $\text{PATH}(\tilde{f}(\pi))$ .

Now we show that the row lengths will be the same. Consider the  $i$ -th row from the bottom (starting with  $i = 1$  for the bottom row) in each partition. Suppose the first-column hook-length in this row in  $f(\pi)$  is  $k$ . By definition, the length of this row in  $f(\pi)$  will be  $k - i + 1$ . Additionally, since we are in the  $i$ -th row from the bottom, it follows that of the values  $\{0, 1, 2, \dots, k-1\}$ , exactly  $i - 1$  are levels of lattice squares below  $\text{PATH}(\pi)$ , while the remaining  $k - i + 1$  values are levels of lattice squares above  $\text{PATH}(\pi)$ . But the levels corresponding to squares above  $\text{PATH}(\pi)$  map to E's under  $\tilde{f}$ . So  $|\{j : 0 \leq j \leq k \text{ and } z_j = \text{E}\}| = k - i + 1$ , which implies that the number of cells in the  $i$ -th row from the bottom of  $\tilde{f}(\pi)$  will also be  $k - i + 1$ .  $\square$

We now define an analog of the map  $g$  that maps  $\nu = \tilde{f}(\pi) = f(\pi)$  to a new partition  $\rho$ . With the word  $z = z_0 z_1 z_2 \dots$  defined as above, let  $y = y_0 y_1 y_2 \dots$  be the subword of  $z$  formed by retaining only those  $z_i$  for which  $i + a$  is the level (using the W-S convention) of a step of  $\text{PATH}(\pi)$ ; then set  $\tilde{g}(\nu) = \text{PTN}(y)$ . (Technically,  $\tilde{g}$  depends not only on the partition  $\nu$ , but on  $a$ ,  $b$  and  $\pi = \tilde{f}^{-1}(\nu)$  as well. However,  $a$  and  $b$  are fixed and we consider  $\tilde{g}$  only as part of the composition  $\tilde{g} \circ \tilde{f}$ .)

**Lemma 4.10.** *For all  $\pi \in \mathcal{D}_{b,-a}^{\text{ptn}}(a, b)$ ,  $\text{WORD}(\tilde{g} \circ \tilde{f}(\pi)) = \text{sw}_{b,-a}^+ \circ \text{rev}(\text{WORD}(\pi))$ .*

*Proof.* Recall from Table 1 that the sweep map variation on the right side of the lemma acts on  $\text{WORD}(\pi)$  by scanning the levels  $0, 1, 2, \dots$  in this order, sweeping up path steps with levels assigned according to the W-S convention. (Since  $\gcd(a, b) = 1$ , each level appears at most once in  $\text{WORD}(\pi)$ . Also, for  $r = b$  and  $s = -a$ ,  $ra + sb = 0$ .)

To compare this sweep map to the action of  $\tilde{g} \circ \tilde{f}$ , first note that a north step on the frontier of  $\pi$  has level  $i + a$  iff the lattice square directly east of that north step has level  $i$ . Such lattice squares are encoded as  $z_i = \text{N}$  by  $\tilde{f}$  and are then retained by  $\tilde{g}$ . Similarly, an east step on the frontier of  $\pi$  has level  $i + a$  iff the lattice square directly north of that east step has level  $i$ . Such lattice squares are encoded as  $z_i = \text{E}$  by  $\tilde{f}$  and are then retained by  $\tilde{g}$ . All other lattice squares not of these two types are discarded by  $\tilde{g}$ . Thus  $\text{WORD}(\tilde{g} \circ \tilde{f}(\pi))$ , which is precisely the subword of  $z_0 z_1 z_2 \dots$  consisting of letters retained by  $\tilde{g}$ , will be the same word produced by the sweep map.  $\square$

Intuitively, one can think of  $\tilde{f}$  as sweeping up *all* lattice-square levels, and then  $\tilde{g}$  keeps only those levels of squares that are “adjacent” to the frontier of  $\pi$  in the sense described above. Below, we will call these squares *frontier squares* of  $\pi$ .

Before proving our final lemma, we need to introduce some temporary notation for describing the cells and rows of  $\nu = f(\pi) = \tilde{f}(\pi)$ . First, let  $\text{FCHL}_\nu$  be the set of hook-lengths of cells in the first (leftmost) column of  $\nu$ . In our running example,  $\text{FCHL}_\nu = \{1, 2, 4, 5, 8, 9, 11, 15, 18, 25\}$ . Each square  $c$  in the diagram of  $\nu$  lies due north of an east step on the frontier of  $\nu$ , say  $z_i = \text{E}$ ; and  $c$  lies due west of a north step on the frontier of  $\nu$ , say  $z_m = \text{N}$ . Identify the square  $c$  with the ordered pair of labels  $[i, m]$ . Observe that  $[i, m]$  is the label of some cell  $c$  in the diagram of  $\nu$  iff  $0 \leq i < m$  and  $z_i = \text{E}$  and  $z_m = \text{N}$ ; in this case, we must have  $m \in \text{FCHL}_\nu$ . It is routine to check that the hook-length  $h(c)$  is  $m - i$ . For all  $m \in \text{FCHL}_\nu$ , the *row of  $\nu$  indexed by  $m$*  is the row with leftmost cell  $[0, m]$ , whose hook-length is  $m$ .

**Lemma 4.11.** *For all  $\pi \in \mathcal{D}_{b,-a}^{\text{ptn}}(a, b)$ ,  $\tilde{g}(\tilde{f}(\pi)) = g(f(\pi))$ .*

*Proof.* Let  $\nu = \tilde{f}(\pi) = f(\pi)$ . We must show  $g(\nu) = \tilde{g}(\nu)$ .

**Step 1.** We show that  $g$  and  $\tilde{g}$  keep the same rows of  $\nu$ . On one hand, the definition of  $g$  tells us to keep the rows of  $\nu$  indexed by those  $m \in \text{FCHL}_\nu$  appearing as the level of a square immediately east of a north step in  $\text{PATH}(\pi)$ . These squares are the frontier squares of  $\pi$  below  $\text{PATH}(\pi)$ . On the other hand, the definition of  $\tilde{g}$  tells us to retain the frontier steps  $z_m = \text{N}$  of  $\nu$  for those  $m \in \text{FCHL}_\nu$  such that  $m + a$  is the level of a north step of  $\text{PATH}(\pi)$ . As observed in the earlier lemma, these  $m$ 's correspond to  $m$ 's that are the levels of frontier squares of  $\pi$  below  $\text{PATH}(\pi)$ . So  $g$  and  $\tilde{g}$  do retain the same rows of  $\nu$ .

**Step 2.** For each fixed  $m \in \text{FCHL}_\nu$ , we compare the cells in the row of  $\nu$  indexed by  $m$  that are discarded by  $g$  and  $\tilde{g}$ . On one hand, let

$$C_m = \{c : c \text{ is a cell in the row of } \nu \text{ indexed by } m, \text{ and } h(c) > b\}.$$

The cells in  $C_m$  are erased by  $g$ . So, for those row indices  $m$  retained by  $g$ ,  $|C_m|$  is the difference between the length of this row in  $\nu$  and the length of the corresponding row in  $g(\nu)$ . On the other hand, let

$$B_m = \{j : 1 \leq j < m, z_j = \text{E}, \text{ and the square with level } j \text{ is not a frontier square of } \pi\}.$$

The values  $j \in B_m$  index the east steps  $z_j = \text{E}$  prior to the north step  $z_j = m$  that are discarded by  $\tilde{g}$ . So, for those row indices  $m$  retained by  $\tilde{g}$ ,  $|B_m|$  is the difference between the length of this row in  $\nu$  and the length of the corresponding row in  $\tilde{g}(\nu)$ . Since  $g$  and  $\tilde{g}$  retain the same row indices  $m$  (by Step 1), it will now suffice to show that  $|B_m| = |C_m|$  for all  $m \in \text{FCHL}_\nu$ .

**Step 3.** Fix  $m \in \text{FCHL}_\nu$ ; we define bijections  $G : B_m \rightarrow C_m$  and  $H : C_m \rightarrow B_m$ . Given  $j \in B_m$ , let  $G(j) = [j - b, m]$ . Given a cell  $[i, m] \in C_m$ , let  $H([i, m]) = i + b$ . It is clear that  $H \circ G$  and  $G \circ H$  are identity maps, so the proof will be complete once we check that  $G$  does map  $B_m$  into  $C_m$ , and  $H$  does map  $C_m$  into  $B_m$ . Consider a fixed  $j \in B_m$ . Since  $z_j = \text{E}$ ,  $j$  is the level of a square above  $\text{PATH}(\pi)$ , but this square is not a frontier square of  $\pi$ . Hence, the square directly below this square (whose level is  $j - b$ ) is also above  $\text{PATH}(\pi)$ . This implies  $j - b \geq 0$  and  $z_{j-b} = \text{E}$ . Moreover, since  $j < m$ , the hook-length of the cell  $[j - b, m]$  is  $m - (j - b) = b + (m - j) > b$ , proving that  $G(j) = [j - b, m] \in C_m$ . Now consider a fixed cell  $[i, m] \in C_m$ . By definition of  $C_m$ , we must have  $z_i = \text{E}$  and  $m - i > b$ . So the square with level  $i$  is above  $\text{PATH}(\pi)$ , and hence the square with level  $i + b$  is also above  $\text{PATH}(\pi)$  and is not a frontier square of  $\pi$ . In particular,  $z_{i+b} = \text{E}$ . Finally,  $i + b < m$  and  $i + b > 0$ , so  $i + b \in B_m$ . We conclude that  $H([i, m]) \in B_m$ .  $\square$

In our running example, the row indices  $m$  retained by both  $g$  and  $\tilde{g}$  are 5, 9, 15, 25. For  $m = 25$ , we have

$$B_{25} = \{10, 13, 16, 17, 20, 22, 23, 24\};$$

$$C_{25} = \{[0, 25], [3, 25], [6, 25], [7, 25], [10, 25], [12, 25], [13, 25], [14, 25]\}.$$

( $C_{25}$  is the set of the leftmost eight cells in the top row of  $\nu$ .) The map  $j \mapsto [j - 10, 25]$  defines a bijection from  $B_{25}$  to  $C_{25}$ .

**4.3. An Algorithm Based on Semi-Module Generators.** In [12, 13], E. Gorsky and M. Mazin relate the  $q, t$ -Catalan numbers and their generalizations to the homology of compactified Jacobians for singular plane curves with Puiseux pair  $(a, b)$ . In the course of their investigations, they introduce the following map  $G_{b,a}$  on partitions in  $\mathcal{D}_{b,-a}^{\text{ptn}}(a, b)$  (we follow the notation of [13]). Let  $a, b \in \mathbb{Z}_{>0}$  with  $\gcd(a, b) = 1$  and  $\pi \in \mathcal{D}_{b,-a}^{\text{ptn}}(a, b)$ . For  $1 \leq i \leq b$ , define the  **$b$ -generators of  $\pi$** , denoted  $\beta_1 < \dots < \beta_b$ , to be the levels of the squares immediately above  $\text{PATH}(\pi)$ . Define  $\Delta = \Delta(\pi)$  to be the set of levels of *all* lattice squares lying north or west of  $\text{PATH}(\pi)$  (i.e., including squares not adjacent to  $\text{PATH}(\pi)$ ). Equivalently,  $\Delta = \mathbb{Z}_{\geq 0} \setminus \Delta^c$  where  $\Delta^c$  is the finite set of levels of lattice squares between  $\text{PATH}(\pi)$  and  $by = ax$ . We then define a new partition  $\rho = G_{b,a}(\pi)$  by setting the  $i$ -th column of  $\rho$  to have length

$$g_{b,a}(\beta_i) = |\{\beta_i, \beta_i + 1, \dots, \beta_i + a - 1\} \setminus \Delta| = |\{\beta_i, \beta_i + 1, \dots, \beta_i + a - 1\} \cap \Delta^c|.$$

For our running example where  $\pi = (4, 4, 4, 2, 2, 1)$ ,  $a = 7$ , and  $b = 10$ , the 10-generators are  $\{0, 3, 6, 7, 12, 14, 19, 21, 28, 35\}$ ,

$$\Delta^c = \{1, 2, 4, 5, 8, 9, 11, 15, 18, 25\},$$

and  $\Delta = \mathbb{Z}_{\geq 0} \setminus \Delta^c$ . It follows that

$$\begin{aligned} g_{10,7}(0) &= |\{0, \dots, 6\} \setminus \{0, 3, 6\}| = 4, \\ g_{10,7}(3) &= |\{3, \dots, 9\} \setminus \{3, 6, 7\}| = 4, \\ g_{10,7}(6) &= |\{6, \dots, 12\} \setminus \{6, 7, 10, 12\}| = 3, \\ g_{10,7}(7) &= |\{7, \dots, 13\} \setminus \{7, 10, 12, 13\}| = 3, \\ g_{10,7}(12) &= |\{12, \dots, 18\} \setminus \{12, 13, 14, 16, 17\}| = 2, \\ g_{10,7}(14) &= |\{14, \dots, 20\} \setminus \{14, 16, 17, 19, 20\}| = 2, \\ g_{10,7}(19) &= |\{19, \dots, 25\} \setminus \{19, 20, 21, 22, 23, 24\}| = 1, \\ g_{10,7}(21) &= |\{21, \dots, 27\} \setminus \{21, 22, 23, 24, 26, 27\}| = 1, \\ g_{10,7}(28) &= |\{28, \dots, 34\} \setminus \{28, \dots, 34\}| = 0, \\ g_{10,7}(35) &= |\{35, \dots, 41\} \setminus \{35, \dots, 41\}| = 0. \end{aligned}$$

The vector  $(g_{10,7}(0), g_{10,7}(3), \dots, g_{10,7}(35)) = (4, 4, 3, 3, 2, 2, 1, 1)$  gives the column lengths of the partition  $\rho = G_{7,3}(\pi) = (8, 6, 4, 2)$ . See Figure 5.

The preceding example suggests that the Gorsky-Mazin map coincides with the map discussed in §4.2. We now prove this fact.

**Theorem 4.12.** *For  $a, b \in \mathbb{Z}_{>0}$  with  $\gcd(a, b) = 1$  and all  $\pi \in \mathcal{D}_{b,-a}^{\text{ptn}}(a, b)$ ,*

$$\text{WORD}(G(\pi)) = \text{sw}_{b,-a}^+ \circ \text{rev}(\text{WORD}(\pi)).$$

*Proof.* Let  $\pi \in \mathcal{D}_{b,-a}^{\text{ptn}}(a, b)$  have  $b$ -generators  $\beta_1 < \beta_2 < \dots < \beta_b$ . Recall from Table 1 that  $\text{sw}_{b,-a}^+ \circ \text{rev}$  uses the west-south convention to assign levels to steps of a lattice path. It follows that the levels of east steps in  $\text{PATH}(\pi)$  are precisely the numbers  $a + \beta_1 < a + \beta_2 < \dots < a + \beta_b$ . The  $i$ -th east step in the output of  $\text{sw}_{b,-a}^+ \circ \text{rev}$  will be preceded by all the north steps whose levels are

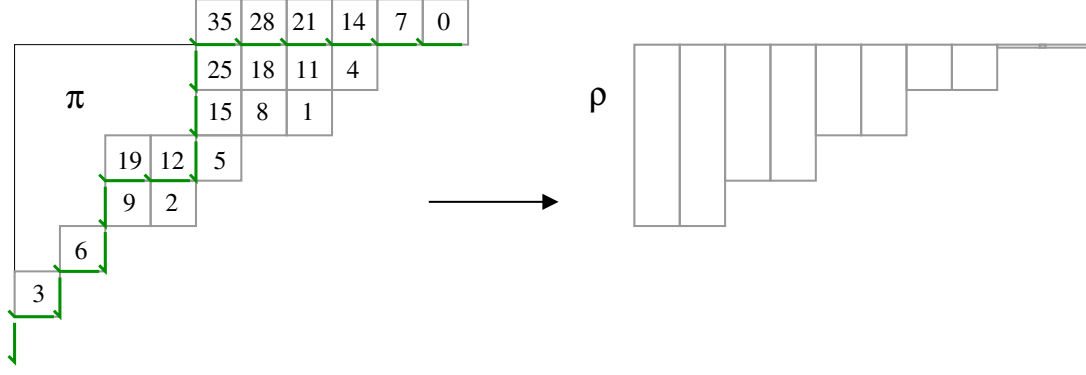

FIGURE 5. Example of the Gorsky-Mazin map  $G_{7,3}$ .

less than  $a + \beta_i$  and followed by all the north steps whose levels are greater than  $a + \beta_i$ . Since the output has exactly  $a$  north steps total, it will suffice to prove (for each fixed  $i$ ) that

$$(\text{the number of north steps of level } < a + \beta_i) + g_{b,a}(\beta_i) = a.$$

For each north step of level  $a + k$ , the lattice square with level  $k$  lies below  $\text{PATH}(\pi)$ , but all of the squares to the left lie west of  $\text{PATH}(\pi)$  and have levels of the form  $k + ja$  for some  $j \in \mathbb{Z}_{\geq 1}$ . On the other hand, for each  $b$ -generator  $\beta_i$ ,  $g_{b,a}(\beta_i)$  is the number of levels in the set  $\{\beta_i, \beta_i + 1, \dots, \beta_i + a - 1\}$  that are the levels of squares below  $\text{PATH}(\pi)$ . For each north step of level  $a + k$  with  $k \geq \beta_i$ ,

$$|\{\beta_i, \dots, \beta_i + a - 1\} \cap \{k + ja\}_{j>0}| = 0.$$

But for each north step of level  $a + k$  with  $k < \beta_i$ , then the cardinality will be exactly 1. Thus the number of levels removed from the  $a$ -element set  $\{\beta_i, \dots, \beta_i + a - 1\}$  to obtain  $g_{b,a}(\beta_i)$  is the same as the number of north steps of level  $< a + \beta_i$ , as needed.  $\square$

## 5. INVERTING THE SWEEP MAP

**5.1. Introduction.** The main open problem in this paper is to prove that *all sweep maps are bijections*. Even in the two-letter case, this problem appears to be very difficult in general. Nevertheless, many special cases of the sweep map are known to be invertible. After discussing the basic strategy for inversion (which involves recreating the labels on the output steps by drawing a suitable “bounce path”), we describe the inverse sweep maps that have appeared in the literature in various guises. We omit detailed proofs that the inverse maps work, since these appear in the references.

**5.2. Strategy for Inversion.** In Figure 3, we showed the computation of  $Q = \text{sw}_{3,-2}^-(P)$  where  $P, Q$  are paths in  $\mathcal{R}^{\text{path}}(\mathbb{N}^8 \mathbb{E}^{10})$ . The output  $Q$  is the path shown on the far right of the figure, *not including labels*. Suppose we were given  $Q$  and needed to compute  $P = (\text{sw}_{3,-2}^-)^{-1}(Q)$ . If we could somehow recreate the labels on the steps of  $Q$  (as shown in the figure), then the sweep map could be easily inverted, as follows. By counting the total number of north and east steps, we deduce that  $P$  must end at level  $8 \cdot 3 + 10 \cdot (-2) = 4$ . We now reconstruct the steps of  $P$  in reverse order. The last step of  $P$  must be the first step of  $Q$  in the collection of steps labeled 4 (since, when sweeping  $P$  to produce  $Q$ , level 4 is swept from right to left). We mark that step of  $Q$  as being used. Since it is a north step, the preceding step of  $P$  must end at level 1. We now take the first unused step of  $Q$  labeled 1 (which is a north step), mark it as used, and note that the preceding step of  $P$  must end at level  $-2$ . We continue similarly, producing  $P$  in reverse until reaching the origin, and marking steps in  $Q$  as they are used. Because  $Q$  is in the image of the sweep map,

this process must succeed (in the sense that all steps of  $Q$  are used at the end, and we never get stuck at some level where all steps in  $Q$  with that label have already been used). Evidently, the strategy outlined here works for any choice of weights, including the general case of alphabets with more than one letter. Variations of the sweep map (such as  $\text{sw}^+$ ) can be handled analogously. The crucial question is *how to recreate the labels on the steps of  $Q$* .

This question has been answered in the literature for Dyck paths,  $m$ -Dyck paths, trapezoidal lattice paths, square paths, Schröder paths,  $(n, nm + 1)$ -Dyck paths, and  $(n, nm - 1)$ -Dyck paths. In every known case, the key to recreating the labels is to define a *bounce path* for a lattice path  $Q$ . The steps of  $Q$  associated with the “ $i$ -th bounce” in the bounce path receive label  $i$ . Once labels have been assigned, one can reverse the sweep map as described in the previous paragraph. We begin by discussing the simplest instance of the bounce path, which is used to invert the map  $\text{sw}_{1,-1}^- = \phi_{\text{HL}}$  (see §4.1.2) acting on Dyck paths. Ironically, several different authors independently introduced inverse sweep maps even before the map  $\phi_{\text{HL}}$  was proposed in the context of  $q, t$ -Catalan numbers. We describe these inverses in §5.4 and §5.5 below.

**5.3. Inversion of  $\phi_{\text{HL}}$  via Haglund’s Bounce Path.** Figure 6 shows the computation of  $Q = \text{sw}_{1,-1}^-(P) = \phi_{\text{HL}}(P)$  for a Dyck path  $P \in \mathcal{D}^{\text{path}}(\mathbb{N}^{14}\mathbb{E}^{14})$ . To understand how to find  $P = \phi_{\text{HL}}^{-1}(Q)$  given  $Q$ , it suffices (by the above remarks) to see how to pass from the unlabeled path  $Q$  on the right side of the figure to the labeled path in the middle of the figure.

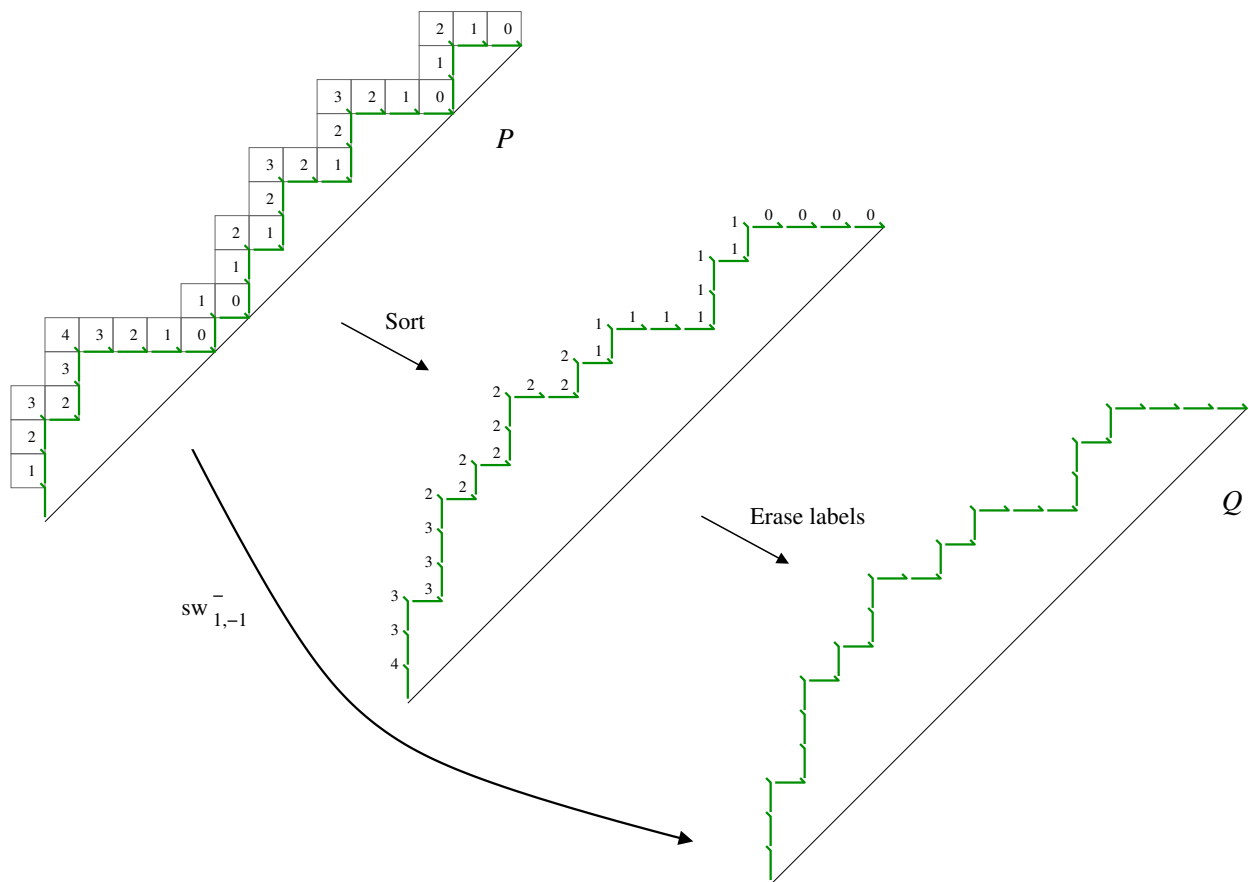

FIGURE 6. Illustration of the action of  $\text{sw}_{1,-1}^-$  on a path  $P \in \mathcal{D}^{\text{path}}(\mathbb{N}^{14}\mathbb{E}^{14})$ .

To recreate the labels, we draw the *bounce path* for the Dyck path  $Q$ , using the following definition due to Haglund [14]. The bounce path starts at  $(n, n)$  and makes a sequence of horizontal moves  $H_i$  and vertical moves  $V_i$ , for  $i = 0, 1, 2, \dots$ , until reaching  $(0, 0)$ . Each horizontal move is determined by moving west from the current position as far as possible without going strictly left of the path  $Q$ . Then the next vertical move goes south back to the diagonal  $y = x$ . Figure 7 shows the bounce path for our example path  $Q$ . In this example, the labels we are trying to recreate are related to the bounce path as follows: every step of  $Q$  located above the bounce move  $H_i$  and to the left of bounce move  $V_{i-1}$  has label  $i$ . As special cases, the steps of  $Q$  above  $H_0$  have label zero, and the steps of  $Q$  to the left of the last bounce move  $V_s$  have label  $s + 1$ . We claim that this relation between the labels and the bounce path holds in general, for any Dyck path  $Q$  of the form  $\phi_{\text{HL}}(P)$ . This claim implies that  $P$  can be uniquely recovered from  $Q$ , so that  $\phi_{\text{HL}}$  is injective and hence bijective.

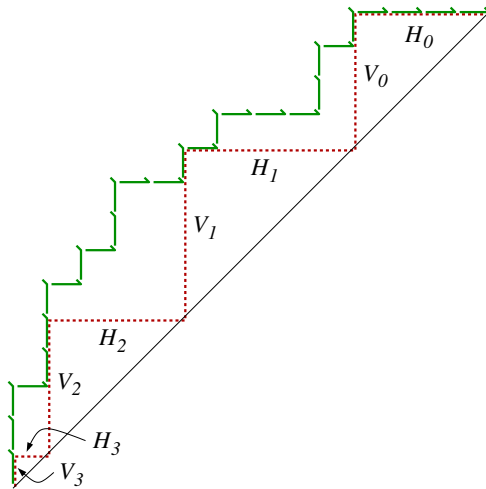

FIGURE 7. Bounce path for path  $Q$  of Figure 6.

To prove the claim, let  $h_i$  be the length of the horizontal move  $H_i$  of the bounce path for  $Q$ , and let  $v_i = h_i$  be the length of the vertical move  $V_i$  of the bounce path for  $Q$ . Also define  $v_i = h_i = 0$  for  $i < 0$  and  $i > s$ , where  $s + 1$  is the total number of horizontal bounces. Finally, let  $n_i$  (resp.  $e_i$ ) denote the number of north (resp. east) steps of  $P$  with  $(1, -1)$ -level equal to  $i$ .

We first prove this lemma:  $n_i = e_{i-1}$  for all  $i \in \mathbb{Z}$ . For any level  $i$ , the number of times the path  $P$  arrives at this level (via a north step of level  $i$  or an east step of level  $i$ ) equals the number of times  $P$  leaves this level (via a north step of level  $i + 1$  or an east step of level  $i - 1$ ). This holds even when  $i = 0$ , since  $P$  begins and ends at level zero. It follows that  $n_i + e_i = n_{i+1} + e_{i-1}$  for all  $i \in \mathbb{Z}$ . Also  $n_i = 0$  for all  $i \leq 0$ , and  $e_i = 0$  for all  $i < 0$ . Thus  $n_i = e_{i-1} = 0$  for all integers  $i \leq 0$ . Fix an integer  $i \geq 0$ , and assume that  $n_i = e_{i-1}$ . Then  $n_{i+1} = n_i + e_i - e_{i-1} = e_i$ , so the lemma follows by induction.

Now we show that for all  $i \in \mathbb{Z}$ ,  $h_i = e_i$  and  $v_{i-1} = n_i$ . Since  $P$  is a Dyck path, the assertion holds for all  $i < 0$ . We prove the two equalities for  $i \geq 0$  by induction on  $i$ , starting with the base case of  $i = 0$ . Recall that the steps of  $P$  are swept in decreasing order by level. We know that  $v_{-1} = n_0 = 0$ . Since  $n_0 = 0$ , the path  $Q$  ends in  $e_0$  east steps. Hence  $h_0 \geq e_0$ . Since  $P$  starts at level 0, the first step in  $P$  at *any* level  $i > 0$  must be a north step. It follows that the last step in  $Q$  labeled with a 1 is a north step and, consequently, that  $h_0 = e_0$ .

Assume now that  $h_k = e_k$  and  $v_{k-1} = n_k$  for some fixed  $k \geq 0$ . It follows from the bounce mechanism that  $v_k = h_k$ . We know that  $h_k = e_k$  by the induction hypothesis. Finally,  $e_k = n_{k+1}$





the break diagonal. (Since the negative bounce path is blocked by lattice points, not edges, on  $Q$ , this rule is not the reflection of the rule for the positive bounce path.) One can check that when sweeping  $P$  to produce  $Q$ , the steps of  $Q$  located north of move  $H_i$  and west of move  $V_{i-1}$  receive label  $i$ . It is now straightforward to invert  $\phi_{LW}$ .

**5.8. Inverting  $\phi_{EHKK}$ .** Egge, Haglund, Killpatrick, and Kremer describe the inverse of their map  $\phi_{EHKK}$  in [9, p. 15]. Given a Schröder path  $Q$ , their algorithm to compute  $P = \phi_{EHKK}^{-1}(Q)$  begins by dividing the steps of  $Q$  into regions based on a version of the bounce path defined for Schröder paths. This amounts to reconstructing the labels of the steps of  $Q$  created when applying the sweep map to  $P$ . They then reconstruct the area vector of  $P$  (modified to allow diagonal steps) by an insertion process that reverses the action of the sweep map. This special case of sweep inversion is notable because it inverts a sweep map on a three-letter alphabet (although one of the letters has weight zero).

**5.9. Inverting  $G_{b,a}$ .** In [13], Gorsky and Mazin describe how to invert special cases of their map  $G_{b,a}$  using the language of semi-module generators and bounce paths. Their results amount to inverting  $\text{sw}_{b,-n}$  on the domain  $\mathcal{D}^{\text{path}}(\mathbb{N}^n \mathbb{E}^b)$  in the case where  $b = nm \pm 1$  for some  $m$ . The case  $b = nm + 1$  essentially duplicates the  $m$ -bounce path construction of [16] (although there is a lot of new material relating this construction to semi-modules). The case  $b = nm - 1$  is a new inversion result obtained via a modification of the  $m$ -bounce paths. Specifically, one constructs the bounce path's vertical moves  $v_i$  (for  $i \geq 0$ ) as described in §5.6 above, but now  $h_i = v_i + v_{i-1} + \dots + v_{i-(m-1)} + t$ , where  $t = -1$  for  $i = m - 1$  and  $t = 0$  for all other  $i$ .

## 6. AREA STATISTICS AND GENERALIZED $q, t$ -CATALAN NUMBERS

This section applies the sweep map to provide new combinatorial generalizations of the  $q, t$ -Catalan numbers [11] and the  $q, t$ -square numbers [20]. We make several conjectures regarding the joint symmetry of these polynomials and their connections to the nabla operator  $\nabla$  on symmetric functions introduced by A. Garsia and F. Bergeron [5, 6, 7].

**6.1. Area Statistics.** For any word  $w \in \{\mathbb{N}, \mathbb{E}\}^*$ , let  $\text{area}(w)$  be the number of pairs  $i < j$  with  $w_i = \mathbb{E}$  and  $w_j = \mathbb{N}$ . This is the area of the partition diagram  $\text{PTN}(w)$  consisting of the squares above and to the left of steps in  $\text{PATH}(w)$ . For  $r, s \in \mathbb{Z}$ , let  $w$  have  $(r, s)$ -levels  $l_0, l_1, \dots$  ( $\mathbb{E}$ - $\mathbb{N}$  convention). Let  $\text{ml}_{r,s}(w) = \min\{l_0, l_1, \dots\}$ , and set  $\text{area}_{r,s}^*(w) = \text{area}(w) + \text{ml}_{r,s}(w)$ . Note that  $\text{area}_{r,s}^*(w) \neq \text{area}_{rm,sm}^*(w)$  in general, so we cannot necessarily assume that  $\text{gcd}(r, s) = 1$  when using  $\text{area}^*$ .

**Remark 6.1.** The function  $\text{ml}_{b,-a}$  appears in [3] as  $\text{ml}_{b,a}$ .

**Remark 6.2.** The correspondence between partitions and paths lying in a fixed triangle has led to inconsistent terminology: “area” can refer to either the number of squares lying in the partition determined by a path (as above) or the number of squares between the path and a diagonal (such as in [3]).

**6.2. Generalized  $q, t$ -Catalan Polynomials.** For  $r, s \in \mathbb{Z}$  and  $a, b \geq 0$ , define the  $q, t$ -Catalan numbers for slope  $(-s/r)$  ending at  $(b, a)$  by

$$C_{r,s,a,b}(q, t) = \sum_{w \in \mathcal{D}_{r,s}^{\text{word}}(\mathbb{N}^a \mathbb{E}^b)} q^{\text{area}(w)} t^{\text{area}(\text{sw}_{r,s}^-(w))}.$$

**Conjecture 6.3 (Joint Symmetry).** For all  $r, s \in \mathbb{Z}$  and all  $a, b \geq 0$ ,  $C_{r,s,a,b}(q, t) = C_{r,s,a,b}(t, q)$ .

Note that the conjectured bijectivity of  $\text{sw}_{r,s}^-$  on the domain  $\mathcal{D}_{r,s}^{\text{word}}(\mathbb{N}^a \mathbb{E}^b)$  would imply the weaker univariate symmetry property  $C_{r,s,a,b}(q, 1) = C_{r,s,a,b}(1, q)$ .

The rational  $q, t$ -Catalan polynomials defined in [3] arise from a sweep map that, in the case  $\gcd(a, b) = 1$  considered in that paper, reduces to  $\text{sw}_{b,-a}^+ \circ \text{rev}$ . As such, the joint symmetry conjecture [3, Conj. 19] is not quite a special case of Conjecture 6.3.

Let  $w \in \mathcal{D}_{1,-1}^{\text{path}}(\mathbb{N}^n \mathbb{E}^n)$  be a ‘‘classical’’ Dyck path with area vector  $(g_1, \dots, g_n)$  (see §4.1.2). Let  $\text{Area}(w) = g_1 + \dots + g_n$ , which is the number of area squares between the path  $w$  and the line  $y = x$ , and let  $\text{dinv}(w)$  be the number of  $i < j$  with  $g_i - g_j \in \{0, 1\}$ . The Garsia-Haiman  $q, t$ -Catalan numbers [11] can be defined by the combinatorial formula

$$C_n(q, t) = \sum_{w \in \mathcal{D}_{1,-1}^{\text{path}}(\mathbb{N}^n \mathbb{E}^n)} q^{\text{Area}(w)} t^{\text{dinv}(w)}.$$

To relate this polynomial to the one defined above, note that  $\text{area}(w) + \text{Area}(w) = n(n-1)/2$ . Similarly, it follows from Theorem 4.2 and [16, §2.5] that  $\text{area}(\text{sw}_{1,-1}^-(w)) + \text{dinv}(w) = n(n-1)/2$ . Therefore,

$$C_n(q, t) = (qt)^{n(n-1)/2} C_{1,-1,n,n}(1/q, 1/t).$$

Combining this with a theorem of Garsia and Haglund [10], we get

$$(qt)^{n(n-1)/2} C_{1,-1,n,n}(1/q, 1/t) = \langle \nabla(e_n), s_{(1^n)} \rangle.$$

More generally, for any positive integers  $m, n$ , the higher-order  $q, t$ -Catalan numbers [16, 17] satisfy

$$C_n^{(m)}(q, t) = (qt)^{mn(n-1)/2} C_{m,-1,n,mn}(1/q, 1/t).$$

The main conjecture for these polynomials can be stated as follows:

$$(qt)^{mn(n-1)/2} C_{m,-1,n,mn}(1/q, 1/t) = \langle \nabla^m(e_n), s_{(1^n)} \rangle.$$

An interesting open problem is to find formulas relating the general polynomials  $C_{r,s,a,b}(q, t)$  to nabla or related operators.

**6.3. Generalized  $q, t$ -Square Numbers.** Next we generalize the  $q, t$ -square numbers studied in [20]. For  $a, b \geq 0$ , define the  **$q, t$ -rectangle numbers for the  $a \times b$  rectangle** by

$$S_{a,b}(q, t) = \sum_{w \in \mathcal{R}^{\text{word}}(\mathbb{N}^a \mathbb{E}^b)} q^{\text{area}_{b,-a}^*(w)} t^{\text{area}_{b,-a}^*(\text{sw}_{b,-a}^-(w))}.$$

**Conjecture 6.4 (Joint Symmetry).** *For all  $a, b$ ,  $S_{a,b}(q, t) = S_{a,b}(t, q)$ .*

The joint symmetry conjecture is known to hold when  $a = b$ . This follows from the stronger statement

$$(qt)^{n(n-1)/2} S_{n,n}(1/q, 1/t) = 2 \langle (-1)^{n-1} \nabla(p_n), s_{(1^n)} \rangle,$$

which was conjectured in [20] and proved in [8]. We conjecture the following more general relationship between certain  $q, t$ -rectangle numbers and higher powers of  $\nabla$ .

**Conjecture 6.5.** *For all  $m \geq 0$  and  $n > 0$ ,*

$$(qt)^{mn(n-1)/2} S_{n,mn}(1/q, 1/t) = (-1)^{n-1} (m+1) \langle \nabla^m(p_n), s_{(1^n)} \rangle.$$

**6.4. Specialization at  $t = 1/q$ .** Recall the definitions of  $q$ -integers,  $q$ -factorials, and  $q$ -binomial coefficients:  $[n]_q = 1 + q + q^2 + \dots + q^{n-1}$ ,  $[n]!_q = [n]_q [n-1]_q \dots [2]_q [1]_q$ , and  $\begin{bmatrix} a+b \\ a, b \end{bmatrix}_q = [a+b]!_q / ([a]!_q [b]!_q)$ .

In [3, Conj. 21], the authors make the following conjecture for coprime  $a$  and  $b$ :

$$q^{(a-1)(b-1)/2} \sum_{D \in \mathcal{D}^{\text{word}}(\mathbb{N}^a \mathbb{E}^b)} q^{\text{area}(\text{sw}_{b,-a}^+(\text{rev}(D))) - \text{area}(D)} = \frac{1}{[a+b]_q} \begin{bmatrix} a+b \\ a, b \end{bmatrix}_q.$$

We conjecture here that  $\text{sw}_{b,-a}^+ \circ \text{rev}$  can be replaced by  $\text{sw}_{b,-a}^-$ :

**Conjecture 6.6.** For all coprime  $a, b > 0$ ,

$$q^{(a-1)(b-1)/2} C'_{b,-a,a,b}(q, 1/q) = \frac{1}{[a+b]_q} \begin{bmatrix} a+b \\ a, b \end{bmatrix}_q.$$

We also introduce two conjectures regarding the  $t = 1/q$  specialization of paths in a rectangle.

**Conjecture 6.7.** For all  $m, n \geq 0$ ,

$$q^{m \binom{n}{2}} S_{n, mn}(q, 1/q) = \frac{(m+1)}{[m+1]_{q^n}} \begin{bmatrix} mn+n \\ mn, n \end{bmatrix}_q.$$

This conjecture generalizes to arbitrary rectangles as follows:

**Conjecture 6.8.** For all  $a, b \geq 0$ , write  $b = b'k$  and  $a = a'k$  for integers  $a', b', k \geq 0$  with  $\gcd(a', b') = 1$ . Then

$$q^{k(a'-1)(b'-1)/2 + a'b' \binom{k}{2}} S_{a,b}(q, 1/q) = \frac{(a'+b')}{[a'+b']_{q^k}} \begin{bmatrix} a+b \\ a, b \end{bmatrix}_q.$$

**Remark 6.9.** A Sage worksheet containing code to compute the images of paths under various versions of the sweep map as well as to check the conjectures of Section 6 can be found at the third author's web page [22].

#### ACKNOWLEDGMENTS

The authors gratefully acknowledge discussions with Jim Haglund, Mark Haiman and Michelle Wachs.

#### REFERENCES

- [1] George Andrews, Christian Krattenthaler, Luigi Orsina, and Paolo Papi, “ $ad$ -Nilpotent  $\mathfrak{b}$ -ideals in  $sl(n)$  having a fixed class of nilpotence: combinatorics and enumeration,” *Trans. Amer. Math. Soc.* **354** no. 10 (2002), 3835–3853.
- [2] Drew Armstrong, Christopher R. H. Hanusa, and Brant C. Jones, “Results and conjectures on simultaneous core partitions,” <http://arxiv.org/abs/1308.0572>.
- [3] Drew Armstrong, Nicholas A. Loehr, and Gregory S. Warrington, “Rational parking functions and Catalan numbers,” <http://arxiv.org/abs/1403.1845>.
- [4] Nicholas A. Loehr and Gregory S. Warrington, “Sweep maps for lattice paths,” 12-page extended abstract accepted as a poster for *FPSAC 2014*.
- [5] F. Bergeron and A. Garsia, “Science Fiction and Macdonald Polynomials,” *CRM Proceedings and Lecture Notes AMS VI* **3** (1999), 363–429.
- [6] F. Bergeron, N. Bergeron, A. Garsia, M. Haiman, and G. Tesler, “Lattice Diagram Polynomials and Extended Pieri Rules,” *Adv. in Math.* **2** (1999), 244–334.
- [7] F. Bergeron, A. Garsia, M. Haiman, and G. Tesler, “Identities and Positivity Conjectures for some remarkable Operators in the Theory of Symmetric Functions,” *Methods and Applications of Analysis VII* **3** (1999), 363–420.
- [8] Mahir Can and Nicholas A. Loehr, “A proof of the  $q, t$ -square conjecture,” *J. Combin. Theory Ser. A* **113** (2006), 1419–1434.
- [9] Eric Egge, Jim Haglund, Kendra Killpatrick, and Darla Kremer, “A Schröder generalization of Haglund’s statistic on Catalan paths,” *Electron. J. of Combin.* **10** (2003), Research Paper 16, 21 pages (electronic).
- [10] A. Garsia and J. Haglund, “A proof of the  $q, t$ -Catalan positivity conjecture,” *LACIM 2000 Conference on Combinatorics, Computer Science, and Applications* (Montreal), *Discrete Math.* **256** (2002), 677–717.
- [11] Adriano Garsia and Mark Haiman, “A remarkable  $q, t$ -Catalan sequence and  $q$ -Lagrange inversion,” *J. Algebraic Combin.* **5** (1996), 191–244.
- [12] Evgeny Gorsky and Mikhail Mazin, “Compactified Jacobians and  $q, t$ -Catalan numbers, I,” *J. Combin. Theory Ser. A* **120** (2013), 49–63. Also online at [arXiv:1105.1151v2](https://arxiv.org/abs/1105.1151v2).
- [13] Evgeny Gorsky and Mikhail Mazin, “Compactified Jacobians and  $q, t$ -Catalan numbers, II,” *J. Algebraic Combin.* **39** (2014), no. 1, 153–186.
- [14] James Haglund, “Conjectured statistics for the  $q, t$ -Catalan numbers,” *Adv. in Math.* **175** (2003), 319–334.

- [15] James Haglund and Nicholas A. Loehr, “A conjectured combinatorial formula for the Hilbert series for diagonal harmonics,” *Discrete Math.* **298** (2005), 189–204.
- [16] Nicholas A. Loehr, “Conjectured statistics for the higher  $q, t$ -Catalan sequences,” *Electron. J. Combin.* **12** (2005) research paper R9; 54 pages (electronic).
- [17] Nicholas A. Loehr, *Multivariate analogues of Catalan numbers, parking functions, and their extensions*. Doctoral dissertation, University of California at San Diego (2003), 267 pages.
- [18] Nicholas A. Loehr, “Trapezoidal lattice paths and multivariate analogues,” *Adv. in Appl. Math.* **31** (2003), 597–629.
- [19] Nicholas A. Loehr and Gregory S. Warrington, “A continuous family of partition statistics equidistributed with length,” *J. Combin. Theory Ser. A* **116** (2009), 379–403.
- [20] Nicholas A. Loehr and Gregory S. Warrington, “Square  $q, t$ -lattice paths and  $\nabla(p_n)$ ,” *Trans. Amer. Math. Soc.* **359** (2007), 649–669.
- [21] J. Vaillé, “Une bijection explicative de plusieurs propriétés remarquables des ponts,” *European J. Combin.* **18** (1997), no. 1, 117–124.
- [22] Gregory S. Warrington, *Sage worksheet for computing sweep maps (available online)*, 2014. <http://www.cems.uvm.edu/~gswarrin/research/sweep.sws>.

DEPT. OF MATHEMATICS, UNIVERSITY OF MIAMI, CORAL GABLES, FL 33146  
*E-mail address:* `armstrong@math.miami.edu`

DEPT. OF MATHEMATICS, VIRGINIA TECH, BLACKSBURG, VA 24061-0123, AND MATHEMATICS DEPT., UNITED STATES NAVAL ACADEMY, ANNAPOLIS, MD 21402-5002  
*E-mail address:* `nloehr@vt.edu`

DEPT. OF MATHEMATICS AND STATISTICS, UNIVERSITY OF VERMONT, BURLINGTON, VT 05401  
*E-mail address:* `gregory.warrington@uvm.edu`