

RANDOM INFINITE SQUARINGS OF RECTANGLES

LOUIGI ADDARIO-BERRY AND NICHOLAS LEAVITT

ABSTRACT. A recent preprint [1] introduced a growth procedure for planar maps, whose almost sure limit is “the uniform infinite 3-connected planar map”. A classical construction of Brooks, Smith, Stone and Tutte [7] associates a squaring of a rectangle (i.e. a tiling of a rectangle by squares) to any to finite, edge-rooted planar map with non-separating root edge. We use this construction together with the map growth procedure to define a growing sequence of squarings of rectangles. We prove the sequence of squarings converges to an almost sure limit: a random infinite squaring of a finite rectangle. This provides a canonical planar embedding of the uniform infinite 3-connected planar map. We also show that the limiting random squaring almost surely has a unique point of accumulation.

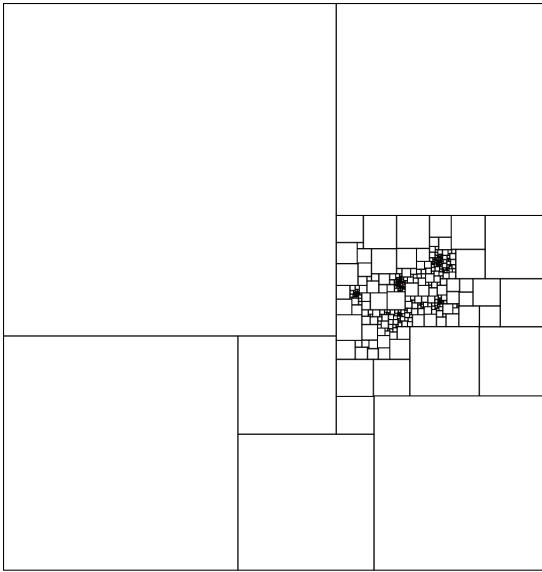

(A) A random squaring of a rectangle with 6345 squares.

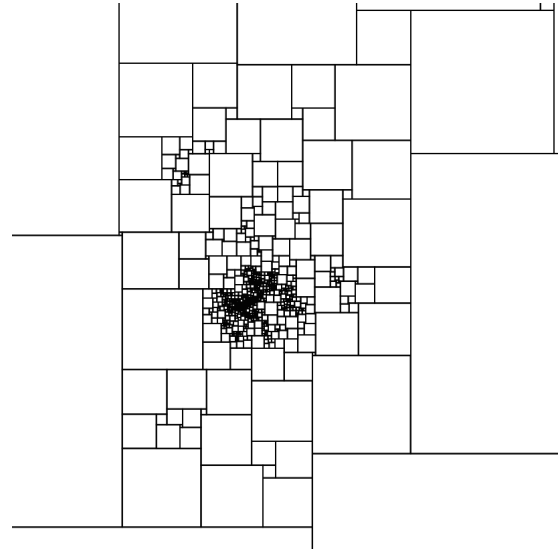

(B) A magnification of a small region within the same squaring.

1. Introduction

In the proceedings of the 2006 ICM, Oded Schramm [25] suggested the problem of determining the Gromov-Hausdorff (GH) distributional limit of uniform triangulations of the sphere and noted the connection, predicted in the physics literature, between such a limit and what he called “the enigmatic KPZ formula . . . relating exponents in quantum gravity to the corresponding exponents in plane geometry”. Since that time, research in the area has exploded. Le Gall’s [16] proof that uniform triangulations have the metric space

Date: May 12, 2014.

L.A.-B. was supported by an NSERC Discovery Grant and an FQRNT Nouveaux Chercheurs Grant during this research.

called the *Brownian map* as their GH limit¹, and Duplantier and Sheffield’s [10] rigorous formulation and proof of the KPZ scaling relation for “Liouville quantum gravity” (LQG) are two recent highlights within the subject.

It has proved challenging to establish a direct connection between the Brownian map and LQG.² A major obstacle is that although the Brownian map is known to have the *topology* of the 2-sphere \mathbb{S}^2 [15, 21], GH convergence alone is not strong enough to yield a canonical random metric (distance function) d on \mathbb{S}^2 so that (\mathbb{S}^2, d) has the law of the Brownian map. In seeking such a metric d , it is natural to consider discrete models of maps that at least have natural canonical embeddings in \mathbb{S}^2 . Such considerations led Le Gall [16, 17] to suggest the study of uniform 3-connected triangulations, for which one may use the associated circle packings to define canonical embeddings.³

In this paper, we instead study uniform 3-connected planar maps (or equivalently, by Whitney’s theorem, planar graphs) without constraints on face degrees.⁴ A classic result of Brooks’, Smith, Stone and Tutte [7] canonically associates a *squaring of a rectangle* to any finite edge-rooted planar map $G = (G, st)$ whose root edge is not a cut-edge; furthermore, any squaring of a rectangle may be so obtained. We write $S(G)$ for this squaring, which is the union of a collection of line segments in \mathbb{R}^2 . Here is the main result of the current paper.

Theorem 1.1. *There exists an explicitly defined sequence $(S_n, n \geq 1)$ of random squarings of rectangles, S_n being composed of n squares, which converges almost surely for the Hausdorff distance to a compact limit S_∞ . Furthermore, S_∞ a.s. has exactly one point of accumulation and has the law of $S(\mathbf{G}_\infty)$, where \mathbf{G}_∞ is “the uniform infinite 3-connected planar map”.*

For a given graph $G = (G, st)$, the calculation of $S(G)$ is accomplished by viewing G as an electrical network with potential difference one between the ends of the root edge, finding the potentials at the vertices of G , then applying a simple geometric construction which we shortly describe. This is all accomplished by solving the equations given by Kirchoff’s laws. Furthermore, the resulting geometric representation is closely linked to the properties of simple random walk on G . The simplicity and explicit nature of the construction, the connection with electrical networks, and the definition of S_∞ as an almost sure (rather than distributional) limit together lead us to view Theorem 1.1 as a promising tool for connecting random maps with LQG. Several precise questions, some in this vein, appear in Section 6.

We conclude the introduction with a brief sketch of what follows. Section 2 primarily introduces the objects of study and describes existing results of which we make use. In particular, in Section 2.3 we describe the Brooks-Smith-Stone-Tutte construction of squarings from planar maps. In Section 2.4, we construct the sequence $(S_n, 1 \leq n \leq \infty) = (S(\mathbf{G}_n), 1 \leq n \leq \infty)$ from an a.s. convergent sequence $(\mathbf{G}_n, 1 \leq n \leq \infty)$ of random maps introduced in a recent preprint of the first author [1]; we then establish the Hausdorff convergence of S_n to S_∞ in Section 3. In Section 4 we analyze the contacts graph of the

¹Independently and roughly simultaneously, Miermont [20] proved a similar result for uniform quadrangulations.

²We should note that the very recent preprint of Miller and Sheffield [22] announces a new project, whose “ultimate aim ... is to rigorously construct the metric space structure of the corresponding $[\gamma^2 = 8/3]$ LQG surface and to show that the random metric space obtained this way agrees in law with a form of the Brownian map.”

³The circle-packing theorem states that such an embedding is unique up to conformal automorphisms.

⁴A graph G is 3-connected if the removal of any two vertices v, v' leaves G connected. Similarly, a graph G is 2-connected if it has no *cut-vertex*, i.e., no vertex v whose removal disconnects G .

limit S_∞ , showing that it is a.s. vertex-parabolic and one-ended. Theorem 1.1 is then easily deduced in Section 5. Finally, Section 6 contains questions and conjectures.

2. Preliminaries: graph limits, squarings, bijections, and recurrence.

2.1. Terminology. For the remainder of the paper, all graphs are assumed to be simple and have finite degrees unless otherwise indicated. For any graph G , write $v(G)$ and $e(G)$ for the vertices and edges of G , respectively, so $G = (v(G), e(G))$. We write $\deg_G(v)$ for the degree of $v \in v(G)$. For $r > 0$, write $B_G(v, r)$ for the subgraph of G induced by vertices at graph distance at most r from v . Given $A \subset e(G)$ we write $G - A$ for the graph $(v(G), e(G) \setminus A)$, and given $U \subset v(G)$ we write $G - U$ for the subgraph of G induced by $v(G) \setminus U$. Finally, a *rooted graph* is a pair (G, v) where G is a graph and $v \in v(G)$.

2.2. Distributional limits of graphs. Given rooted graphs $G = (G, \rho)$ and $G' = (G', \rho')$, we say the *distance* between G and G' is $1/(r+1)$, where r is the greatest value for which $(B_G(\rho, r), \rho)$ and $(B_{G'}(\rho', r), \rho')$ are isomorphic (as rooted graphs). The distance between two graphs is zero precisely if they are isomorphic, so it is straightforward to show this distance defines a metric on the set of isomorphism classes of locally finite rooted graphs. Convergence for this metric is often called *local weak* or *Benjamini-Schramm* convergence of graphs [2, 6]. A sequence $((G_n, \rho_n), n \geq 1)$ converges in the local weak sense precisely if there exists a graph (G_∞, ρ_∞) such that for any $r > 0$ and all n sufficiently large, $(B_{G_n}(\rho_n, r), \rho_n)$ and $(B_{G_\infty}(\rho_\infty, r), \rho_\infty)$ are isomorphic. A sequence $((G_n, \rho_n), n \geq 1)$ of *random* rooted graphs converges in *distribution* in the local weak sense if for every finite rooted graph (G, ρ) , $\mathbb{P}(B_{G_n}(\rho_n, r) = (G, \rho))$ converges as $n \rightarrow \infty$.

Recall that simple random walk on a locally finite graph G is the Markov chain $(X_n, n \geq 0)$ on $v(G)$ with transition probabilities $p_{uv} = 1/\deg(u)$ for $\{u, v\} \in e(G)$, and $p_{uv} = 0$ otherwise. If G is finite, then the simple random walk has stationary measure π given by $\pi(v) = \deg_G(v)/2|e(G)|$ for all $v \in v(G)$. The graph G is *recurrent* if for all $v \in v(G)$, $\mathbb{P}(\exists n > 0 : X_n = v | X_0 = v) = 1$. Equivalently, G is recurrent if and only if when edges are viewed as unit resistors, the electrical resistance from any node to infinity is infinite.

We next state a beautiful theorem of Gurel-Gurevich and Nachmias [12], which we use below. A random infinite graph (G, ρ) is a *distributional limit of finite planar graphs* if there exists a sequence (G_n, ρ_n) of random finite planar graphs such that (a) for each n , conditional on G_n , the root ρ_n is distributed according to the stationary measure on $v(G_n)$,⁵ and (b) (G_n, ρ_n) converges in distribution in the local weak sense to (G, ρ) . Finally, say a random variable X has *exponential tail* if there exists $c > 0$ such that $\mathbb{P}(X > t) \leq e^{-ct}$ for all sufficiently large t .

Theorem 2.1 ([12], Theorem 1.1). *Let (U, ρ) be a distributional limit of finite planar graphs such that the degree of ρ has exponential tail. Then U is almost surely recurrent.*

2.3. Squarings of rectangles. An *edge-rooted map* is a pair (G, st) , where G is a connected planar graph, properly embedded in \mathbb{R}^2 such that the distinguished directed edge st lies in the unique unbounded face of $G - \{s, t\}$. We write (G^*, s^*t^*) for the planar dual of (G, st) , with the convention that the tail s^* of s^*t^* is in the face lying to the right of st . For $e \in e(G)$ write e^* for the dual edge to e in (G^*, s^*t^*) . A map is *locally finite* if all vertices and faces have bounded degree. Throughout this section, $G = (G, st)$ denotes a fixed, locally finite edge-rooted map such that $G - \{s, t\}$ is connected (in this case $G^* - \{s^*, t^*\}$ is also connected).

⁵See [6] for a more detailed discussion of this condition.

A *squaring of a rectangle* is a closed set $S \subset \mathbb{R}^2$ such that all bounded components of $\mathbb{R}^2 \setminus S$ are (open) squares, and the closure of the union of all such bounded components is a compact rectangle. The *squares* of S are the closures of the connected components of $\mathbb{R}^2 \setminus S$ (note that here we include the unbounded component). It is easily seen that S is recoverable from its set of squares.

We now define the squaring $S(G)$ associated to an edge-rooted map $G = (G, st)$; this construction was discovered by Brooks, Smith, Stone, and Tutte [7]. (Another, rather different way to define squarings using maps was later described by Schramm [24].) The definition is illustrated in Figure 1. First associate an electrical network with G as follows. Cut st , connect a 1 volt power supply to s , ground at t , and let edges act as unit resistors. Write $\lambda(G)$ for the total current flowing from s to t . For $v \in v(G)$, write $P(v)$ for the potential at v (equivalently, $P(v)$ is the probability a simple random walk starting from v first visits s before first visiting t). We note the following identity, which is an immediate consequence of conservation of current flow and Ohm's law, for later reference:

$$(1) \quad \lambda(G) = \sum_{v \sim s, v \neq t} (1 - P(v)) = \deg_G(s) - 1 - \sum_{v \sim s} P(v).$$

Next, to each edge $e \in e(G) \setminus \{s, t\}$, associate a square s_e whose side length is equal to the current flowing through e . The position of s_e is determined as follows. With $e = \{u, v\}$, let $y(e) = \max(P(u), P(v))$. Finally, view (G^*, s^*t^*) as an electrical network with potential $\lambda(G)$ at s^* and grounded at t^* . Then for $e \in e(G) \setminus \{s, t\}$, with $e^* = \{u^*, v^*\}$, let $x(e^*) = \min(P(u^*), P(v^*))$. The top left corner of s_e then has position $(x(e^*), y(e))$.

Let $S(G, st)$ be the union of the boundaries of the squares $\{s_e, e \in e(G) \setminus \{s, t\}\}$. It is straightforward to show that $S(G^*, s^*t^*)$ may be obtained by rotating $S(G, st)$ counter-clockwise by 90° , then translating and rescaling so that the squaring has height one and bottom left corner at the origin; this will be useful later.

Theorem 2.2 ([5, 7]). *Let $G = (G, st)$ be a finite, edge rooted, finite planar map such that $G - \{s, t\}$ is connected. Then the squares $\{s_e, e \in e(G) \setminus \{s, t\}\}$ have disjoint interiors, and $S(G)$ is a squaring of the rectangle $[0, \lambda(G)] \times [0, 1]$. Furthermore, S is invertible up to zero current edges.*

Figure 1 contains an edge-rooted map (G, st) with ten edges, and its associated squaring.

Theorem 2.2 applies to finite graphs, but $S(G)$ is defined whenever G and G^* are locally finite (and $G - \{s, t\}$ is connected). In this case, there is no guarantee that $S(G)$ is a squaring of a rectangle, but this is known to hold in some cases (see, e.g., [5]). Proposition 3.3, below, implies that $S(G)$ is a squaring whenever G is recurrent, a fact which we require and were unable to find in the literature.

For the remainder of the section, we assume (G, st) is such that the squares $\{s_e, e \in e(G) \setminus \{s, t\}\}$ have disjoint interiors and such that $S(G, st)$ is a squaring of a rectangle (by Theorem 2.2, this is the case if G is finite, but we do not assume finiteness). For $v \in v(G)$, define a horizontal line segment $\ell(v)$ contained in $S(G, st)$ as follows (see Figure 1). The y -coordinate of $\ell(v)$ is $P(v)$. Next, the leftmost (resp. rightmost) point of $\ell(v)$ is the minimal (resp. maximal) x -coordinate contained in any square s_e for which e is incident to v . (If no current flows through v then $\ell(v)$ consists of a single point; in this case we call $\ell(v)$ *degenerate*, and otherwise we call $\ell(v)$ *non-degenerate*.) Likewise, to each face f of G we associate a vertical line segment $\ell(f)$, which may either be defined directly or using the above observation that the squaring of a graph and of its facial dual are related by a rotation; we omit details. We call $\ell(v)$ and $\ell(f)$ *primal* and *facial* lines of $S(G, st)$, respectively.

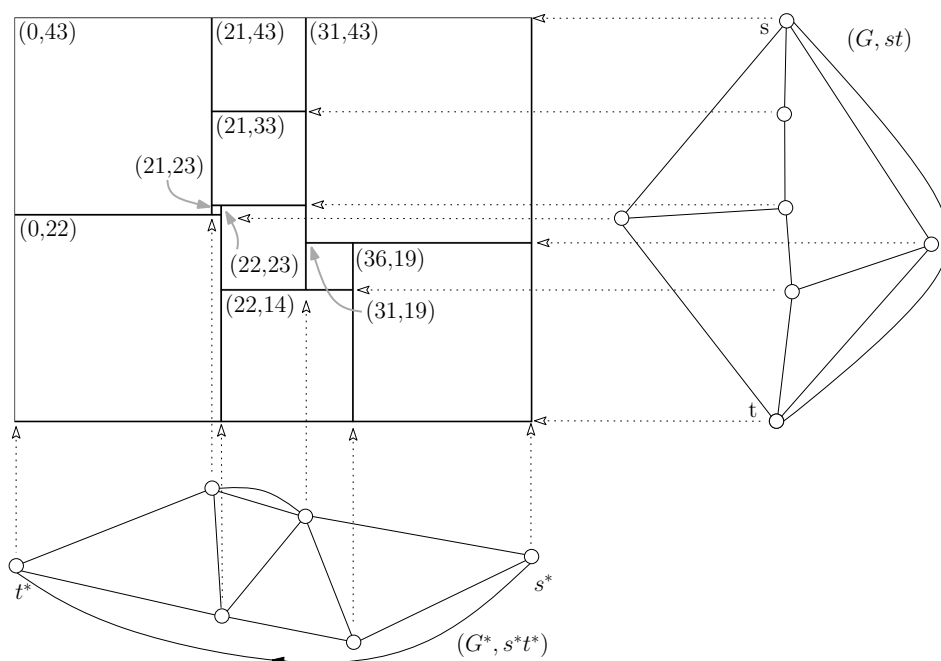

FIGURE 1. A squaring S with ten squares, and the associated edge-rooted map G . The coordinates of the squares' top left corners, rescaled to be integers, are displayed. Horizontal lines connect vertices v of G with the associated line segments $\ell(v) \subset S$; vertical lines connect faces (dual vertices) with the associated line segments.

Observe that if e is incident to vertex v (resp. face f) then $s_e \cap \ell(v)$ is a horizontal border of s_e (resp. $s_e \cap \ell(f)$ is a vertical border of s_e). Similarly, if vertex v is incident to face f in G then there is an edge e incident to both v and f , from which it follows that $\ell(v) \cap \ell(f) \neq \emptyset$. The disjointness of the interiors of the squares $\{s_e, e \in e(G) \setminus \{s, t\}\}$ implies that any distinct lines ℓ, ℓ' , whether primal or facial, are either disjoint or intersect in a single point. It follows that if $\{u, v\} \in e(G)$ then the top and bottom borders of s_e are both contained in $\ell(v) \cup \ell(w)$.

Given a squaring of a rectangle S (with lower left corner at the origin), one may define an edge-rooted map $(G', s't')$ with $S(G', s't') = S$ as follows. The vertices of G' are the maximal horizontal line segments of S . For each square s of S , there is an edge connecting the vertices ℓ, ℓ' of G' that border the top and bottom of s , respectively. The graph $(G', s't')$ need not be even locally finite. However, when $(G', s't')$ is finite then $S(G', s't') = S$ (see [7], Theorem 4.31).

Despite the construction of the preceding paragraph, the function $S(\cdot)$ is not invertible: if the current through $e \in e(G) \setminus \{s, t\}$ is zero, and \hat{G} is obtained from G by either deleting or contracting e , then $S(\hat{G}, st) = S(G, st)$; see Figure 2. However, it is not hard to see that zero-current edges are the only way injectivity can fail. In particular, if S is such that no four squares have a common point of intersection, then there is a unique 2-connected edge-rooted map $(G', s't')$ with squaring S .

We conclude the section with a lemma.

Lemma 2.3. *If (G, st) is a finite 3-connected edge-rooted planar map, then for all vertices v (resp. faces f) of G , $\ell(v)$ (resp. $\ell(f)$) is non-degenerate.*

Proof. Let (G, st) be 3-connected. Suppose there exists $w \in v(G)$ such that $\ell(w)$ is a single point, say $\ell(w) = z \in \mathbb{R}^2$. Then any edge e incident to w has $s_e = z$. Since for any neighbour v of w , $\ell(w)$ is a border of $s_{\{v,w\}}$, for such v we have $z \in \ell(v)$. Letting $U = \{u \in v(G) : z \in \ell(u), u \text{ is non-degenerate}\}$, it follows that U is a cutset in G separating w (and any other vertices w' with $\ell(w') = z$) from s and t . But since distinct lines are either disjoint or intersect in a single point, U has size at most two, which contradicts that G is 3-connected. \square

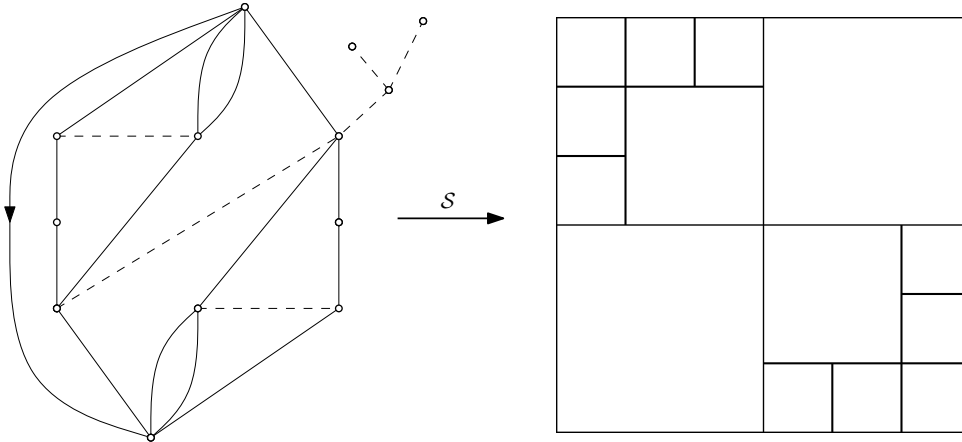

FIGURE 2. An example of the non-invertibility of S . Removing or contracting any of the dotted edges leaves the squaring unchanged.

2.4. Bijections for random trees and maps. Let $T = (T, uv)$ be a finite edge-rooted map which is a *binary tree*: that is, each non-leaf node of T has degree three. Fusy, Poulalhon and Schaeffer [11] described an invertible “closure” operation which transforms T into an edge-rooted *irreducible quadrangulation of a hexagon*, which we denote $Q(T)$.⁶ The construction of $Q(T)$ from T , which we now explain, is illustrated in Figure 3. Perform a clockwise contour exploration of T . Each time a leaf w is followed by four internal vertices x, y, z, a , identify w with a so that the unbounded face lies to the left of the oriented edge wa ; the face to the right will necessarily have degree four. In the modified map, the vertex

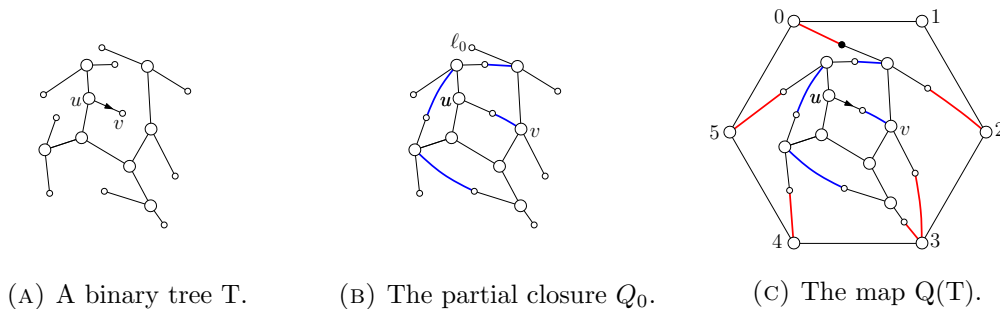

FIGURE 3. Closure edges are drawn with two colours: blue and black if internal, red and black if incident to the hexagonal face.

formed from merging w and a is considered to be internal. Continue exploring the modified map in clockwise fashion, making identifications according to the preceding rule, until no

⁶An edge-rooted map is an irreducible quadrangulation of a hexagon if the unbounded face has degree six, all other faces have degree four, and every cycle of length four bounds a face.

identifications are possible; call the result the *partial closure* of T , and denote it Q_0 (see Figure 3b). A counting argument shows that in Q_0 , at least 3 leaves remain. Write ℓ_0 for the first such leaf encountered by the contour process (in clockwise order starting from uv).

Draw a hexagon in the unbounded face of Q_0 . It can be shown that there is a unique (up to isomorphism of planar maps) way to identify the leaves of Q_0 with vertices of the hexagon so that in the resulting graph, all bounded faces have degree four. The result is the graph $Q(T)$, which we view as rooted at uv (the vertex v may have been identified with another vertex during the closure operation, as in Figure 3c; we abuse notation and continue to use the same name). Write \mathcal{T}_n for the set of edge-rooted binary trees with n internal vertices, and \mathcal{Q}_n for the set of edge-rooted quadrangulations of a hexagon with $n + 6$ vertices, such that the root edge is not incident to the hexagonal face.

Theorem 2.4 ([11]). *For each $n \geq 1$, the closure operation is a bijection between \mathcal{T}_n and \mathcal{Q}_n .*

Given $Q \in \mathcal{Q}_n$, number the vertices of the hexagonal face in clockwise order as $0, \dots, 5$, where 0 is the vertex identified with ℓ_0 by the closure operation. Then, for $i \in \{0, \dots, 5\}$, let $Q^{(i)}$ be obtained from Q by adding the oriented edge from i to $(i+3) \bmod 6$. The result is a doubly edge-rooted quadrangulation (every face has degree four) which may no longer be irreducible. However, we do have the following. Let \mathcal{Q}_n^* be the set of triples $(Q, uv, u'v')$, where Q is an irreducible quadrangulation with $n+6$ vertices and $uv, u'v'$ are oriented edges of Q not lying on a common face, and let $\mathcal{T}_n^* = \{(T, i) \in \mathcal{T}_n \times \{0, \dots, 5\} : Q(T)^{(i)} \in \mathcal{Q}_n^*\}$.

Theorem 2.5 (Fusy Thm 4.8). *The function sending (T, i) to $Q(T)^{(i)}$ restricts to a bijection between \mathcal{T}_n^* and \mathcal{Q}_n^* .*

To conclude the section, we recall Tutte's classical bijection between maps and quadrangulations, which associates to a rooted map (G, uv) a quadrangulation (Q, uv') as follows (see Figure 4 for an illustration). Draw a node v_f in each face f of G . Then for each $u \in v(G)$ and each face f incident to u , add an edge $\{u, v_f\}$. Erase all edges in $E(G)$. Finally, let $v' = v_f$ where f is the face lying to the right of uv . It is well-known (see, e.g., [11], Theorem 3.1) that Tutte's bijection restricts to a bijection between 3-connected, edge-rooted planar maps with n edges and edge-rooted, irreducible quadrangulations with n faces. Thus, combining the closure operation with Tutte's bijection yields a bijection between \mathcal{T}_n and a collection of edge-rooted maps which includes all 3-connected maps with $n + 4$ edges. It turns out that the 3-connected maps comprise an asymptotically constant proportion of the collection; we return to this point in the next section.

2.5. Growth procedures. In this section, we describe the growth procedures, introduced in [1], for random irreducible quadrangulations of a hexagon and to the maps associated to such quadrangulations by Tutte's bijection. We restrict our discussion to the features of the procedures required in the current work, and refer the reader to [1] for further details.

Luczak and Winkler [18] showed that there is a growth procedure for uniformly random binary plane trees. More precisely, there exists a stochastic process $(\mathbf{T}_n)_{n=0}^\infty$, with the following properties. First, for each n , \mathbf{T}_n is uniformly distributed over edge-rooted binary trees with n internal nodes. Second, for all n , \mathbf{T}_n is a subtree of \mathbf{T}_{n+1} .

The sequence $(\mathbf{T}_n, n \geq 1)$ converges almost surely in the local weak sense to a limit \mathbf{T}_∞ , which is essentially a critical Galton-Watson tree whose offspring law μ satisfies $\mu(\{0\}) = \mu(\{2\}) = 1/2$, conditioned to be infinite. It is shown in [1] that the closure operation,

when applied to \mathbf{T}_∞ , yields an infinite, locally finite edge-rooted quadrangulation \mathbf{Q}_∞ , and that $\mathbf{Q}(\mathbf{T}_n) \rightarrow \mathbf{Q}_\infty$ almost surely, in the local weak sense.⁷

Now let i be uniform in $\{0, \dots, 5\}$, let (Q_n, st') be the (singly) edge-rooted quadrangulation obtained from $\mathbf{Q}(\mathbf{T}_n)^{(i)}$ by unrooting at the second root edge (but not deleting the edge), and let $\mathbf{G}_n = (G_n, st)$ be the pre-image of (Q_n, st') under Tutte's bijection. Then (Q_n, st') is irreducible if and only if \mathbf{G}_n is 3-connected. Fusy, Poulalhon and Schaeffer [11] show that $\mathbb{P}(\mathbf{G}_n \text{ is 3-connected}) \rightarrow 2^8/3^6$ as $n \rightarrow \infty$.⁸ They further deduce from the bijective results described in Section 2.4 that the conditional law of \mathbf{G}_n , given that \mathbf{G}_n is 3-connected, is uniform over 3-connected, edge-rooted maps with $n + 4$ edges.

It is an easy consequence of the convergence of $\mathbf{Q}(\mathbf{T}_n)$ to \mathbf{Q}_∞ that \mathbf{G}_n has an a.s. local weak limit $\mathbf{G}_\infty = (G_\infty, st)$, and \mathbf{G}_∞ is obtained from \mathbf{Q}_∞ via Tutte's bijection. We also have the following result.

Theorem 2.6 ([1], Theorem 7). *Let $\hat{\mathbf{G}}_n$ be uniformly distributed on the set of 3-connected rooted maps with $n + 4$ edges; then $\hat{\mathbf{G}}_n$ converges in distribution to \mathbf{G}_∞ in the local weak sense.*

In brief, Theorem 2.6 holds because the failure of \mathbf{G}_n to be 3-connected is caused by the failure of $\mathbf{Q}(\mathbf{T}_n)$ to be irreducible. This is a ‘‘local defect’’, occurring near the hexagon, and the hexagon disappears to infinity in the limit.

Theorem 2.6 implies that G_∞ is a.s. 3-connected, so up to reflection has a unique planar embedding. (The definition of G_∞ as an almost sure limit of a sequence of finite maps also *uniquely* specifies an embedding of G_∞ .) We thus henceforth view G_∞ as a planar map. We conclude the section with a quick application of Theorem 2.1.

Theorem 2.7. *G_∞ and its planar dual G_∞^* are both a.s. recurrent.*

In proving Theorem 2.7, we use the following fact.

Fact 2.8. *The random variable $\deg_{\mathbf{G}_\infty}(s)$ has exponential tail.*

Proof. Let $\hat{\mathbf{G}}_n = (\hat{G}_n, \hat{s}_n \hat{t}_n)$ be as in Theorem 2.6. Then for $d \in \mathbb{N}$, $\mathbb{P}(\deg_{\mathbf{G}_\infty}(s) = d) = \lim_{n \rightarrow \infty} \mathbb{P}(\deg_{\hat{\mathbf{G}}_n}(\hat{s}_n) = d)$. By [4, Theorem 2.1 (a)], for all $\epsilon > 0$ there exists $B > 0$ such that for all $n \in \mathbb{N}$,

$$\mathbb{P}(\deg_{\hat{\mathbf{G}}_n}(\hat{s}_n) = d) < B \cdot \left(\frac{1}{2} + \epsilon\right)^d.$$

The fact follows. □

Proof of Theorem 2.7. By Theorem 2.6, (G_∞, s) is a distributional limit of finite planar graphs; by Fact 2.8 its root degree has exponential tail. The a.s. recurrence of G_∞ then follows from Theorem 2.1. Next, let $\hat{\mathbf{G}}_n$ be as in Theorem 2.6. Then $\hat{\mathbf{G}}_n$ has the same law

⁷In the partial closure of \mathbf{T}_∞ , almost surely no leaves remain, so the addition of the ‘‘external hexagon’’ does not occur. Thus, \mathbf{Q}_∞ is perhaps more accurately described as the partial closure of \mathbf{T}_∞ .

⁸Note that this is a statement about large- n asymptotics of marginal probabilities, and says nothing about the *dynamics* of $(\mathbf{G}_n, n \geq 1)$.

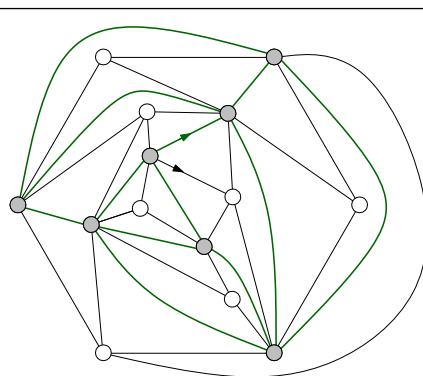

FIGURE 4. An edge-rooted map (grey vertices; thicker, green edges), and its image under Tutte's bijection (grey and white vertices; thinner, black edges).

as its planar dual $\hat{\mathbf{G}}_n^*$, and the latter converges in distribution to \mathbf{G}_∞^* , so G_∞^* is likewise a.s. recurrent. \square

Now for $1 \leq n \leq \infty$, let $S_n = S(\mathbf{G}_n)$ be the squaring associated to \mathbf{G}_n . In the following section, we prove the first part of Theorem 1.1 by showing that $S_n \rightarrow S_\infty$ almost surely, for the Hausdorff distance, as $n \rightarrow \infty$.

3. Convergence of the squarings

Given a graph G , recall that a function $\varphi : v(G) \rightarrow \mathbb{R}$ is called *harmonic* with boundary $D \subset v(G)$ if for all $v \in v(G) \setminus D$,

$$\varphi(v) = \frac{1}{\deg(v)} \sum_{w \sim v} \varphi(w).$$

Let $X = (X_n, n \geq 0)$ be a simple random walk on G . For any set $A \subset v(G)$, let

$$\tau_A = \tau_A(X) = \inf\{n \in \mathbb{N} : X_n \in A\}$$

be the first hitting time of A by the walk. We recall the following standard theorem relating harmonic functions and simple random walks; see, e.g., [23, Section 4.2].

Theorem 3.1. *Let G be a recurrent graph and $\varphi : v(G) \rightarrow \mathbb{R}$ be harmonic with finite boundary D . Then for all $v \in v(G) \setminus D$, $\varphi(v) = \mathbb{E}(\varphi(X_{\tau_D}) \mid X_0 = v)$.*

In order to prove convergence of the squarings S_n to S_∞ , we naturally require the potential at each vertex of G_n to converge to its limiting value in G_∞ . We prove a slightly more general theorem from which such a convergence will follow.

Theorem 3.2. *Let $(H_n, 1 \leq n \leq \infty) = ((H_n, \rho_n), 1 \leq n \leq \infty)$ be a sequence of rooted graphs such that $H_n \rightarrow H_\infty$ in the local weak sense, and such that H_∞ is recurrent. Fix $D \subset v(H_\infty)$ finite, and for each $n \leq \infty$ large enough that $D \subset v(H_n)$, let $\varphi_n : v(H_n) \rightarrow \mathbb{R}$ be a harmonic function on H_n with boundary D . Suppose further that the functions φ_n all agree on D . Then for all $v \in v(G_\infty)$, $\varphi_n(v) \rightarrow \varphi_\infty(v)$ as $n \rightarrow \infty$.*

Proof. Fix $v \in v(H_\infty)$, and let n_0 be large enough that $D \cup \{v\} \subset v(H_n)$ for all $n \geq n_0$. For $n_0 \leq n \leq \infty$ write $X^{(n)} = (X_k^{(n)}, k \geq 0)$ for simple random walk on H_n started from $X_0^{(n)} = v$. In view of Theorem 3.1 and finiteness of D , it is enough to show that for each $b \in D$, $\mathbb{P}(X_{\tau_D(X^{(n)})}^{(n)} = b) \rightarrow \mathbb{P}(X_{\tau_D(X^{(\infty)})}^{(\infty)} = b)$ as $n \rightarrow \infty$. In what follows we write, e.g., τ_D instead of $\tau_D(X^{(n)})$ for readability; the omitted argument should be clear from context.

Let $E_n(r) = \{\tau_{B_{H_n}(v,r)^c} < \tau_D\}$ be the event that $X^{(n)}$ reaches distance r from v before hitting D . Since H_∞ is recurrent, $\mathbb{P}(E_\infty(r)) \rightarrow 0$ as $r \rightarrow \infty$.

Next, fix r_0 large enough that $D \subset B_{H_\infty}(v, r_0)$. For $r \geq r_0$, by taking $N = N(r)$ large enough that $B_{H_n}(v, r+1)$ is constant for $n > N$, for such n and for all $u \in D$ we have

$$\mathbb{P}(E_\infty(r), X_{\tau_D}^{(n)} = u) = \mathbb{P}(E_n(r), X_{\tau_D}^{(\infty)} = u).$$

Summing over $u \in D$, this also implies that for such n , $\mathbb{P}(E_n(r)) = \mathbb{P}(E_\infty(r))$.

Now let $\epsilon > 0$ be arbitrary, fix $R > r_0$ large enough that $\mathbb{P}_\infty(E(R)) < \epsilon$, and let $N = N(R)$ be as above. Then for $u \in D$, for $n > N$,

$$\begin{aligned} \mathbb{P}(X_{\tau_D}^{(n)} = u) &= \mathbb{P}(E_\infty(r)^c, X_{\tau_D}^{(n)} = u) + \mathbb{P}(E_\infty(v, r), X_{\tau_D}^{(n)} = u) \\ &< \mathbb{P}(E_\infty(r)^c, X_{\tau_D}^{(n)} = u) + \epsilon \\ &= \mathbb{P}(E_n(r)^c, X_{\tau_D}^{(\infty)} = u) + \epsilon \\ &\leq \mathbb{P}(X_{\tau_D}^{(\infty)} = u) + \epsilon \end{aligned}$$

A symmetric argument shows that $\mathbb{P}(X_{\tau_D}^{(n)} = u) > \mathbb{P}(X_{\tau_D}^{(\infty)} = u) - \epsilon$, and thus

$$|\mathbb{P}_n(X_{\tau_n}^{(n)} = \varphi(u)) - \mathbb{P}_\infty(X_\tau = \varphi(u))| < \epsilon.$$

□

Proposition 3.3. *Let $(H_n, 1 \leq n \leq \infty) = ((H_n, st), 1 \leq n \leq \infty)$ be a sequence of locally finite, edge-rooted recurrent planar maps such that $H_n - \{s, t\}$ is connected for all $1 \leq n \leq \infty$ and such that $H_n \rightarrow H_\infty$ in the local weak sense. Then $S(H_\infty)$ is a squaring of a rectangle, and $S(H_n) \rightarrow S(H_\infty)$ as $n \rightarrow \infty$, for the Hausdorff distance.*

Proof. First assume that H_n is finite for $1 \leq n < \infty$. Let λ_n be the total current flowing through H_n , and let $y_n : v(H_n) \rightarrow \mathbb{R}$ be the potential on H_n . Then let $x_n : v(H_n^*) \rightarrow \mathbb{R}$ be the potential on the dual graph H_n^* when a potential of λ_n is applied at t^* and the graph is grounded at s^* . Now fix an edge $e = \{u, v\}$ of H_∞ . Then for n sufficiently large that $e \in e(H_n)$, the square corresponding to e in $S(H_n)$ is bounded by the horizontal lines with y -coordinates $y_n(u)$ and $y_n(v)$, and the vertical lines with x -coordinates $x_n(u^*)$ and $x_n(v^*)$. Since y_n is harmonic with boundary $y_n(s) = 1$ and $y_n(t) = 0$, by Theorem 3.2, y_n converges pointwise. Furthermore, recall from (1) that

$$\lambda_n = \deg_n(s) - 1 - \sum_{w \sim s} y_n(w)$$

which in particular implies that λ_n converges.

Now let $\hat{x}_n : v(H_n^*) \rightarrow \mathbb{R}$ be harmonic on H_n^* with boundary $\hat{x}_n(t^*) = 1$ and $\hat{x}_n(s^*) = 0$. By uniqueness and linearity of harmonic functions, $x_n = \lambda_n \hat{x}_n$. But \hat{x}_n converges by Theorem 3.2, so the same is true of x_n . It follows that square positions and sizes converge to their limiting values. For all n , the interiors of squares of $S(H_n)$ are pairwise disjoint; since the position and size of each square converges, the same must hold in $S(H_\infty)$.

By its definition, $S(H_n)$ is contained within $[0, \lambda_n] \times [0, 1]$ for each $1 \leq n \leq \infty$. Since $\lambda_n \rightarrow \lambda_\infty$, the squarings $(S(H_n), 1 \leq n \leq \infty)$ are uniformly bounded in \mathbb{R}^2 . Furthermore, it is immediate from the energy formulation of resistance (see [19, Proposition 9.2]) that λ_∞ is precisely the sum of the areas of the squares $\{s_e, e \in e(H_\infty)\}$. Since these squares have disjoint interiors, they must therefore tile $[0, \lambda_\infty] \times [0, 1]$; in other words, $S(H_\infty)$ is a squaring of $[0, \lambda_\infty] \times [0, 1]$. It is then immediate that $S(H_n) \rightarrow S(H_\infty)$ in the Hausdorff sense.

We now allow that H_n is infinite for $1 \leq n < \infty$. View H_n as a local weak limit of finite graphs; then the preceding case shows that $S(H_n)$ is a squaring of a rectangle for each n , and a reprise of the above arguments then shows that $S(H_n) \rightarrow S(H_\infty)$ in the Hausdorff sense. □

Corollary 3.4. *The squarings S_n converge almost surely to a squaring S_∞ as $n \rightarrow \infty$, for the Hausdorff distance, and $S_\infty = S(G_\infty)$. Furthermore, S_∞ has infinitely many squares of positive area. Finally, for all vertices v (resp. faces f) of G_∞ , $\ell(v)$ (resp. $\ell(f)$) is non-degenerate.*

Proof. In view of Proposition 3.3, the convergence is immediate from the a.s. convergence of \mathbf{G}_n to \mathbf{G}_∞ described in Section 2.5, and the a.s. recurrence of \mathbf{G}_∞ from Theorem 2.7. Next, Theorem 2.6 implies that G_∞ is a.s. 3-connected. It follows by the same argument as for Lemma 2.3 that the lines $\ell(v)$, $v \in v(G_\infty)$ are all non-degenerate. On the other hand, a non-degenerate line $\ell(v)$ must neighbour a non-degenerate square s_e (in fact, at least 3 such squares since G_∞ is 3-connected, but we do not need this). Each square borders only two primal lines, so there must be an infinite number of non-degenerate squares. \square

4. Only one point of accumulation

To show that S_∞ a.s. has only one point of accumulation, we use a result of He and Schramm [13], which requires a brief introduction. A *packing* is a collection $\{P_i, i \in I\}$ of measurable subsets of \mathbb{R}^2 such that for each $i \in I$, the interior of P_i is disjoint from $\bigcup_{j \in I \setminus \{i\}} P_j$. Its *contacts graph* is the graph $R = R(\{P_i, i \in I\})$ with vertices $\{P_i, i \in I\}$ and edges $\{\{P_i, P_j\} : P_i \cap P_j \neq \emptyset\}$.

A measurable set $A \subset \mathbb{R}^2$ is δ -*fat* if for all $x \in B$ and all $r > 0$ with $A \setminus B(x, r) \neq \emptyset$, $\text{Leb}(A \cap B(x, r)) \geq \delta \text{Leb}(B(x, r))$.⁹ To quote from [13], “a set is fat if its area is roughly proportional to the square of its diameter, and this property also holds locally”.

A packing $\{P_i, i \in I\}$ is *fat* if there is $\delta > 0$ such that P_i is δ -fat for all $i \in I$. It is *well-separated* if for each P_i , the set $\bigcup_{P_j \sim P_i} P_j \setminus P_i$ contains a Jordan curve separating P_i from $\bigcup_{P_j \not\sim P_i} P_j \setminus P_i$.

A graph G is *one-ended* if for any finite set $U \subset v(G)$, $G - U$ has exactly one infinite connected component. It is *edge-parabolic* if there exists a function $m : e(G) \rightarrow [0, \infty)$ with $\sum_{e \in e(G)} m(e)^2 < \infty$ such that for any infinite path γ in G , $\sum_{e \in e(\gamma)} m(e) = \infty$. Likewise, it is *vertex-parabolic* if there exists a function $m' : v(G) \rightarrow [0, \infty)$ with $\sum_{v \in v(G)} m'(v)^2 < \infty$ such that for any infinite path γ in G , $\sum_{v \in v(\gamma)} m'(v) = \infty$. For locally finite graphs, edge-parabolicity is equivalent to recurrence [8, 9, 13], and edge-parabolicity implies (but is not equivalent to) vertex-parabolicity [13].

Theorem 4.1 ([13], Theorem 6.1). *If $(P_i, i \in I)$ is a well-separated fat packing, and its contacts graph R is locally finite, one-ended and vertex-parabolic, then $\bigcup_{i \in I} P_i$ has a single point of accumulation.*

We abuse notation by writing $R(S_\infty)$ for the contacts graph of the packing given by the squares of S_∞ . This packing is a.s. fat since all its bounded components are squares, and the aspect ratio of the rectangle they tile is a.s. finite. Since it tiles all of space, it is also easily seen to be well-separated. To conclude that S_∞ has a single point of accumulation, it thus suffices to prove the following two propositions.

Proposition 4.2. *$R(S_\infty)$ is almost surely vertex-parabolic.*

Proposition 4.3. *$R(S_\infty)$ is almost surely one-ended.*

We begin by proving Proposition 4.3, which is a consequence of the following straightforward fact. Slight modifications of Fact 4.4 have already appeared in the literature [3, 14].

Fact 4.4. *\mathbf{Q}_∞ is almost surely one-ended.*

⁹Leb denotes Lebesgue measure in \mathbb{R}^2 .

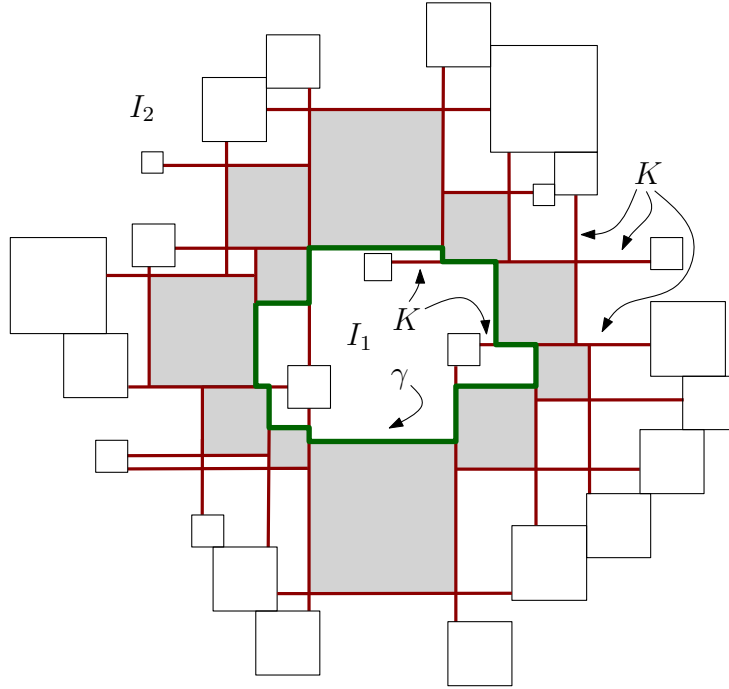

FIGURE 5. The set $\{s_i, i \in I\}$ is given by the grey squares. Thicker lines (both red and green) are the lines $\ell(u)$ for $u \in K$. The thickest, dark-green, closed path is one possibility for γ .

Proof. First, \mathbf{T}_∞ is a.s. one-ended; this is well-known, but in particular follows from the explicit description of \mathbf{T}_∞ given in [18] and reprised in [1]. Next, for any finite set $U \subset v(\mathbf{Q}_\infty)$, if \hat{U} is the pre-image of U in $v(\mathbf{T}_\infty)$ then $\mathbf{T}_\infty - \hat{U}$ has at least as many infinite connected components as $\mathbf{Q}_\infty - U$; this is immediate from the fact that \mathbf{T}_∞ is formed from \mathbf{Q}_∞ by making vertex identifications, since both \mathbf{T}_∞ and \mathbf{Q}_∞ are a.s. locally finite. Thus, for finite U , $\mathbf{Q}_\infty - U$ a.s. has at most one infinite connected component; on the other hand, it a.s. has at least one such component since \mathbf{Q}_∞ is a.s. locally finite. \square

Proof of Proposition 4.3. We identify \mathbf{Q}_∞ with the set $v(G_\infty) \cup f(G_\infty)$, where $f(G_\infty)$ denotes the set of faces of G_∞ , so edges of \mathbf{Q}_∞ precisely encode incidences between vertices and faces in G_∞ . With this identification, for $u \in v(\mathbf{Q}_\infty)$ we write $\ell(u)$ for the horizontal or vertical line segment corresponding to u as described at the end of Section 2.3.

Let $\{s_i, i \in I\}$ be a finite set of squares in $v(R(S_\infty))$ such that $\bigcup_{i \in I} s_i$ is simply connected. Then the set of squares in $v(R(S_\infty)) \setminus \{s_i, i \in I\}$ incident to some square in $\{s_i, i \in I\}$ induces a connected subgraph of $R(S_\infty)$, from which it is immediate that $R(S_\infty) - \{s_i, i \in I\}$ is (graph theoretically) connected. This implies that any finite separating set in $R(S_\infty)$ contains a cycle in $R(S_\infty)$.

Note that by Corollary 3.4 $R(S_\infty)$ is a.s. an infinite graph. Now suppose $R(S_\infty)$ is not one-ended, let $\{s_i, i \in I\} \subset v(R(S_\infty))$ be such that $R(S_\infty) - \{s_i, i \in I\}$ contains at least two infinite connected components, and write I_1, I_2 for two such infinite components. Note that $\bigcup_{i \in I} \partial s_i$ contains a simple closed path γ in \mathbb{R}^2 such that (relabelling I_1 and I_2 if necessary) all squares in I_1 (resp. I_2) lie in the interior (resp. exterior) of γ ; see Figure 5. Let J_1 (resp. J_2) be the set of vertices u of \mathbf{Q}_∞ with $\ell(u)$ strictly contained in the interior (resp. exterior) of γ . It is clear that $\mathbf{Q}_\infty[J_1]$ and $\mathbf{Q}_\infty[J_2]$ each contain at least one infinite connected component.

The set $\bigcup_{i \in I} \partial s_i$ consists of finitely many horizontal and vertical line segments; let

$$K = \left\{ u \in v(\mathbf{Q}_\infty) : \ell(u) \cap \bigcup_{i \in I} \partial s_i \neq \emptyset \right\}.$$

Since \mathbf{Q}_∞ is locally finite and S_∞ contains no degenerate lines, K is a finite set. Now let $P = (u_1, u_2, \dots, u_m)$ be any path in \mathbf{Q}_∞ joining J_1 and J_2 . Then $\gamma \cap \bigcup_{i=1}^m \ell(u_i) \neq \emptyset$, so P must contain a vertex from K . Therefore $\mathbf{Q}_\infty - K$ has at least two infinite connected components, contradicting Fact 4.4. \square

The remainder of the section is devoted to proving Proposition 4.2. It is natural to try a direct appeal to Theorem 2.1 to show that $R(S_\infty)$ is recurrent. However, our information about the law of the sequence $(R(S_n), n \geq 1)$ seems too weak to apply this approach. More precisely, root $R(S_n)$ at its vertex which corresponds to the unbounded component of S_n . It is not clear how to show that the law of this vertex is (exactly or approximately) stationary conditional on $R(S_n)$.¹⁰ Furthermore, we do not see an obvious choice of root vertex which would improve matters.

Instead of applying Theorem 2.1 to the contact graphs, we first define a sequence of graphs $(D_n, 1 \leq n \leq \infty)$ to which Theorem 2.1 does apply to show that D_∞ is recurrent and so edge-parabolic. We then show that edge-parabolicity of D_∞ implies vertex-parabolicity for $R(S_\infty)$. We now proceed to details.

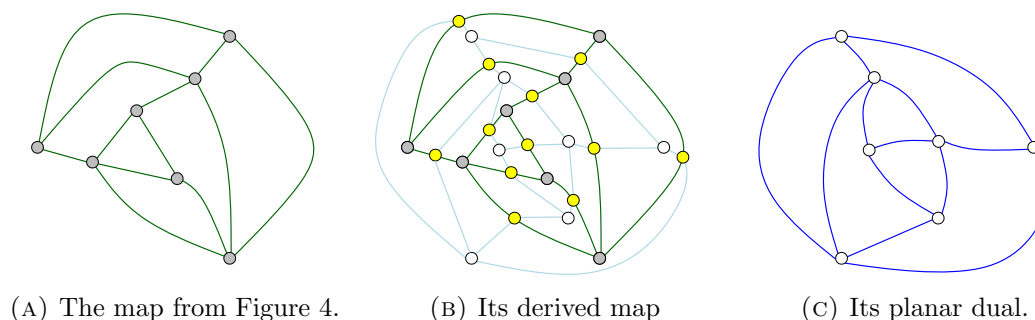

FIGURE 6. The derived map.

Let G be a planar map. The *derived map* of G , denoted $D = D(G)$ is obtained as follows. First, subdivide each edge of G once; call the newly created vertices $\{v_e, e \in e(G)\}$. Second, add a vertex to the interior of each face, and join each facial vertex to all the incident subdivision vertices. See Figure 6. Note that if F is the planar dual of G then $D(F) = D(G)$.

Lemma 4.5. *Let $G = (G, st)$ be a planar map with squaring S . Then the contacts graph $R(S)$ is isomorphic to a subgraph of $D(G)^2$.*

Proof. The vertices $v(R(S))$ correspond to squares of S , and thence to edges of G . This gives a natural map from $v(R(S))$ to the set of subdivision vertices $\{v_e, e \in e(G)\}$. We similarly associate primal vertices of $D(G)$ to vertices of G and thence to primal lines of S , and facial vertices of $D(G)$ to faces of G and thence to facial lines of S . (Primal and facial lines were defined in Section 2.3.)

Fix squares $s, \hat{s} \in v(R(S))$ and write e, \hat{e} for the corresponding edges of G . If s and \hat{s} border a common primal line then e and \hat{e} share a common endpoint, so v_e and $v_{\hat{e}}$ are

¹⁰One way to overcome this difficulty would be to derive more detailed enumerative information about the number of squarings with n squares; question (9) of Section 6 relates to this.

joined by a path of length two in $D(G)$; see Figure 7a. Since the derived graph of G and of the dual of G are identical, the same holds s and \hat{s} border a common facial line. To prove the lemma it thus suffices to show that if v and \hat{v} are adjacent in $R(S)$ then s and \hat{s} border a common primal or facial line. This is obvious unless s and s' meet at a single point $x \in \mathbb{R}^2$.

If the latter occurs then there are precisely 4 squares that meet at x . If two primal lines meet at x then the corresponding vertices of G lie on a common face, and the associated facial line passes through x and thus borders both s and \hat{s} (see Figure 7b). Otherwise, a primal line passes through x and thus borders both s and \hat{s} . In either case s and \hat{s} border a common primal or facial line (see Figure 7c). This completes the proof. \square

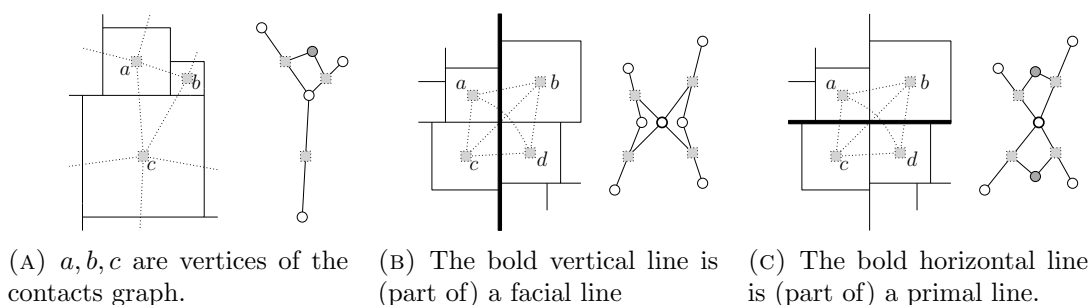

FIGURE 7. Vertices of the contacts graph, and the corresponding vertices of the derived map, are drawn as squares. Primal vertices are white disks, and dual vertices are grey disks.

(A) If two squares border a common primal (resp. facial) line then their corresponding vertices in the derived graph are joined by a path of length 2 through a primal (resp. dual) vertex. (B) and (C): if squares meet at a point then they border a common primal or facial line.

For $1 \leq n \leq \infty$, write D_n for the derived map of G_n .

Lemma 4.6. D_∞ is almost surely recurrent.

Proof. Let $\hat{G}_n = (\hat{G}_n, \hat{s}_n \hat{t}_n)$ be as in Theorem 2.6. Let \hat{D}_n be the derived map of \hat{G}_n , let \hat{v}_n be the subdivision vertex corresponding to $\{\hat{s}_n, \hat{t}_n\}$, and let $\rho_n = \hat{s}_n$ with probability $1/2$ and $\rho_n = \hat{v}_n$ with probability $1/2$. Likewise, let v_{st} be the subdivision vertex corresponding to edge $\{s, t\}$ in G_∞ , and let ρ_∞ be either s or v_{st} , each with probability $1/2$. Then since \hat{G}_n converges in distribution to G_∞ , it also holds that (\hat{D}_n, ρ_n) converges in distribution to (D_∞, ρ_∞) .

Next, since $\hat{s}_n \hat{t}_n$ is a uniformly random edge of \hat{G}_n , it is immediate from the definition of ρ_n that ρ_n is distributed according to the stationary law of \hat{D}_n . It follows that (D_∞, ρ_∞) is a distributional limit of finite planar graphs. Furthermore, if $\rho = s$ then the degree $\deg_{D_\infty}(\rho) = \deg_{G_\infty}(s)$, and otherwise $\deg_{D_\infty}(\rho) = 4$. By Fact 2.8 it follows that $\deg_{D_\infty}(\rho')$ has exponential tails, and thus by Theorem 2.1, D_∞ is almost surely recurrent. \square

Proof of Proposition 4.2. By Lemma 4.6, D_∞ is almost surely recurrent and so edge-parabolic. Let $m : e(D_\infty) \rightarrow [0, \infty)$ be such that $\sum_{e \in e(D_\infty)} m(e)^2 < \infty$ and such that $\sum_{e \in e(\gamma)} m(e)$ is infinite for any infinite path γ in D_∞ . Use m to define a function

$m' : v(R_\infty) \rightarrow [0, \infty)$ as follows. For $s_e \in v(R_\infty)$, let v_e be the corresponding subdivision vertex of the derived graph, and let

$$m'(s_e) = \sum_{\{f \in e(D_\infty) : v_e \in f\}} m(f).$$

In other words, $m'(s_e)$ is the sum of the m -masses of the four edges incident to v_e in the derived graph.

Each subdivision vertex has degree four in the derived graph, and each edge of the derived graph is incident to exactly one subdivision vertex. It follows by Cauchy-Schwarz that

$$\begin{aligned} \sum_{s \in v(R(S_\infty))} m'(s)^2 &= \sum_{e \in e(G_\infty)} \left(\sum_{\{f \in e(D_\infty) : v_e \in f\}} m(f) \right)^2 \\ &\leq \sum_{e \in e(G_\infty)} 4 \sum_{\{f \in e(D_\infty) : v_e \in f\}} m(f)^2 \\ &= \sum_{f \in e(D_\infty)} 4m(f)^2 < \infty. \end{aligned}$$

Now suppose that γ is an infinite path in the contacts graph. Then Lemma 4.5 implies that $\bigcup_{s_e \in v(\gamma)} \{f \in e(D_\infty) : v_e \in f\}$ contains an infinite path γ' in D_∞ . It follows that

$$\sum_{s_e \in v(\gamma)} m'(s_e) = \sum_{s_e \in v(\gamma)} \sum_{\{f \in e(D_\infty) : v_e \in f\}} m(f) \geq \sum_{e \in e(\gamma')} m(e) = \infty,$$

the last equality by our choice of m . Since γ was an arbitrary infinite path, it follows that $R(S_\infty)$ is vertex-parabolic. \square

5. Proof of Theorem 1.1

The a.s. Hausdorff convergence of S_n to $S_\infty = S(\mathbf{G}_\infty)$ was established in Corollary 3.4; it remains to show that S_∞ a.s. has exactly one point of accumulation.

Since S_∞ is an infinite squaring and is compact, it clearly has at least one point of accumulation. The fact that S_∞ has at most one point of accumulation follows from Theorem 4.1, once it is verified that the contacts graph $R(S_\infty)$ is one-ended and vertex-parabolic; this was accomplished in Propositions 4.2 and 4.3. \square

6. Further Questions and Topics

- (1) We begin with an analogue of Conjecture 7.1 of [10] and of Conjecture 1 (a) of [26], for the random squarings S_n . There is a unique translation and scaling under which the image S'_n of S_n is centred at 0 and such that when S'_n is stereographically projected to the Riemann sphere $\mathbb{C}^* = \mathbb{C} \cup \{\infty\}$, the image of the unbounded region of $\mathbb{R}^2 \setminus S_n$ has area $1/n$. Apply this transformation, and let μ_n be the measure on \mathbb{C}^* obtained by letting each connected component of $\mathbb{C}^* \setminus S'_n$ have measure $1/n$.¹¹ Then μ_n should converge weakly to a measure μ on \mathbb{C}^* which is some version of the Liouville quantum gravity measure (possibly the “ γ -unit area quantum sphere

¹¹The measure μ_n is uniquely determined if we also specify that its restriction to any component of $\mathbb{C}^* \setminus S'_n$ is a multiple of the surface measure of the Riemann sphere.

- measure with $\gamma = \sqrt{8/3}$, introduced in [26]). In particular, μ should satisfy a version of the KPZ dimensional scaling relation.
- (2) We expect that the box-counting dimension of S_∞ is a.s. well-defined and constant. More precisely, write n_ϵ for the number of balls of radius ϵ required to cover S_∞ . We expect that $\log n_\epsilon / \log(1/\epsilon) \rightarrow c$ almost surely, where c is non-random. Is this true? If so, what is c ? Is $c > 1$? (Note that for the Hausdorff dimension, if $(C_n, n \in \mathbb{N})$ are measurable sets in \mathbb{R}^2 then $\dim_{\text{Haus}}(\bigcup_{n \in \mathbb{N}} C_n) = \sup_{n \in \mathbb{N}} \dim_{\text{Haus}}(C_n)$. Since S_∞ is a countable union of line segments, it follows that $\dim_{\text{Haus}}(S_\infty) = 1$ almost surely.)
 - (3) Let Z be the a.s. unique accumulation point of S_∞ . Can the law of Z be explicitly described?
 - (4) Write $G_\infty(\epsilon)$ for the graph induced by those vertices for which all incident squares are disjoint from $B(Z, \epsilon)$. How quickly does $G_\infty(\epsilon)$ grow as ϵ decreases? Relatedly, how does the diameter of $G_\infty(\epsilon)$ grow? Existing results about random maps suggest that if the diameter grows as $\epsilon^{-\alpha}$ then the volume should grow as $\epsilon^{-4\alpha}$.
 - (5) The structure of S_∞ near Z should be independent of its structure near the root; here is one question along these lines. Reroot G_∞ by taking one step along a random walk path from the root, write \hat{S}_∞ for the resulting squaring and \hat{Z} for its point of accumulation. Then recenter S_∞ and \hat{S}_∞ so that Z and \hat{Z} sit at the origin. Does $\epsilon^{-1} d_H(S_\infty \cap B(0, \epsilon), \hat{S}_\infty \cap B(0, \epsilon)) \rightarrow 0$ almost surely, as $\epsilon \rightarrow 0$? Here d_H denotes Hausdorff distance.
 - (6) Let $e_n(1), \dots, e_n(k)$ be independent, uniformly random oriented edges of the contacts graph $R(S_n)$, and for $1 \leq i \leq k$ let $r_n(i)$ be the ratio of the side length of the “tail square” of $e_n(i)$ to that of its “head square”. The vector $(r_n(i), 1 \leq i \leq k)$ should converge in distribution to a limit $(r(i), 1 \leq i \leq k)$, whose entries are iid. This would be a very small first step towards establishing that the random squaring in some sense “looks like the exponential of a Gaussian free field”.
 - (7) Let A_n be the adjacency matrix of G_n . The areas of squares may be calculated as determinants of minors of A_n . However, these determinants grow very quickly, and even finding logarithmic asymptotics seems challenging. A simpler, still challenging project is to study the determinant of any principal minor of A_n or, equivalently, to study the number of spanning trees of G_n .
 - (8) The height of S_∞ is 1 but its width W_∞ is random, and by considering the graph structure near the root of G_∞ it is not hard to see that W_∞ is an honest random variable (rather than a.s. constant). On the other hand, duality implies that W_∞ and $1/W_\infty$ have the same law. Can anything explicit be said about this law? In particular, is $\mathbb{P}(W_\infty = 1) > 0$?
 - (9) Simulations suggest that for n large, S_n is unlikely to contain four squares with common intersection. Does this probability indeed tend to zero as n becomes large? This question looks innocent. However, recall that such intersections are the reason the function sending a rooted planar graph to its squaring is non-invertible. A positive answer would constitute substantial progress towards proving an asymptotic formula, conjectured by Tutte [27, Section 9], for the number of perfect squarings with n squares.
 - (10) Let \hat{S}_n be uniformly distributed over squarings of a rectangle with n squares. Does \hat{S}_n converge in distribution to S_∞ for the Hausdorff distance? This follows if the laws of S_n and \hat{S}_n are close, which would itself follow from a positive answer to the previous question.
 - (11) The behaviour of the simple random walk on G_∞ is also of interest. How do quantities such as $\mathbb{P}(X_t = X_0)$, $d_{G_\infty}(X_0, X_t)$, and $\#\{X_s, 0 \leq s \leq t\}$ scale in t ?

- (12) It seems likely that $R(S_\infty)$ is recurrent; is it? Here is one tempting argument for recurrence; its incorrectness was pointed out to us by Ori Gurel-Gurevich. By Lemma 4.5, $R(S_\infty)$ may be viewed as a subgraph of D_∞^2 . Since D_∞ is recurrent, so is D_∞^2 ; then conclude via Rayleigh monotonicity. The problem with the argument is that the recurrence of D_∞ is not known to imply the recurrence of D_∞^2 (this implication would be true if D_∞ had uniformly bounded degrees [19, Theorem 2.16]). Perhaps if G is a recurrent, unimodular random graph whose root degree has exponential tail, then any finite power of G is also recurrent; this would be an interesting fact in its own right.

Acknowledgements. Both authors thank Grégory Miermont for useful comments, and Ori Gurel-Gurevich for pointing out an error in an earlier version of this work. LAB thanks Nicolas Curien and Omer Angel for their insightful remarks subsequent to a presentation of this work at the McGill Bellairs Research Institute, in April 2014.

REFERENCES

- [1] Louigi Addario-Berry. Growing random 3-connected maps, or comment s'enfuir de l'hexagone. arXiv:1402.2632 [math.PR], 2014.
- [2] David Aldous and J. Michael Steele. The objective method: probabilistic combinatorial optimization and local weak convergence. In *Probability on discrete structures*, volume 110 of *Encyclopaedia Math. Sci.*, pages 1–72. Springer, 2004. URL <http://www.stat.berkeley.edu/~aldous/Papers/me101.pdf>.
- [3] Omer Angel and Oded Schramm. Uniform infinite planar triangulations. *Comm. Math. Phys.*, 241(2-3):191–213, 2003. URL <http://arxiv.org/abs/math/0207153>.
- [4] Edward A. Bender and E. Rodney Canfield. Face sizes of 3-polytopes. *J. Combin. Theory Ser. B*, 46(1):58–65, 1989. URL [http://dx.doi.org/10.1016/0095-8956\(89\)90007-5](http://dx.doi.org/10.1016/0095-8956(89)90007-5).
- [5] Itai Benjamini and Oded Schramm. Random walks and harmonic functions on infinite planar graphs using square tilings. *Ann. Probab.*, 24(3):1219–1238, 1996. URL <http://projecteuclid.org/euclid.aop/1065725179>.
- [6] Itai Benjamini and Oded Schramm. Recurrence of distributional limits of finite planar graphs. *Electron. J. Probab.*, 6:no. 23, 13 pp. (electronic), 2001. URL <http://arxiv.org/abs/math/0011019>.
- [7] R. L. Brooks, C. A. B. Smith, A. H. Stone, and W. T. Tutte. The dissection of rectangles into squares. *Duke Math. J.*, 7:312–340, 1940.
- [8] Peter G. Doyle and J. Laurie Snell. *Random walks and electric networks*, volume 22 of *Carus Mathematical Monographs*. Mathematical Association of America, Washington, DC, 1984. URL <http://arxiv.org/abs/math/0001057>.
- [9] R. J. Duffin. The extremal length of a network. *J. Math. Anal. Appl.*, 5:200–215, 1962. ISSN 0022-247x.
- [10] Bertrand Duplantier and Scott Sheffield. Liouville quantum gravity and KPZ. *Inventiones Mathematicae*, 185:333–393, 2011. URL <http://arxiv.org/abs/0808.1560>.
- [11] Éric Fusy, Dominique Poulalhon, and Gilles Schaeffer. Dissections, orientations, and trees with applications to optimal mesh encoding and random sampling. *ACM Trans. Algorithms*, 4(2):19:1–19:48, 2008. URL <http://arxiv.org/abs/0810.2608>.
- [12] Ori Gurel-Gurevich and Asaf Nachmias. Recurrence of planar graph limits. *Ann. of Math. (2)*, 177(2):761–781, 2013. URL <http://arxiv.org/abs/1206.0707>.
- [13] Zheng-Xu He and O. Schramm. Hyperbolic and parabolic packings. *Discrete Comput. Geom.*, 14(2):123–149, 1995.
- [14] Maxim Krikun. Local structure of random quadrangulations. arXiv:math/0512304 [math.PR], 2005.

- [15] Jean-François Le Gall. The topological structure of scaling limits of large planar maps. *Invent. Math.*, 169(3):621–670, 2007.
- [16] Jean-François Le Gall. Uniqueness and universality of the Brownian map. *Ann. Probab.*, 41:2880–2960, 2013. URL <http://arxiv.org/abs/1105.4842>.
- [17] Jean-François Le Gall. Random geometry on the sphere. To appear in the Proceedings of ICM 2014, Seoul, 2014. URL <http://arxiv.org/pdf/1403.7943v1.pdf>.
- [18] Malwina Luczak and Peter Winkler. Building uniformly random subtrees. *Random Structures Algorithms*, 24(4):420–443, 2004. URL <http://www.math.dartmouth.edu/~pw/papers/birds.ps>.
- [19] Russell Lyons and Yuval Peres. Probability on trees and networks. Book in preparation, available via <http://mypage.iu.edu/~rdlyons/prbtree/prbtree.html>, 2005.
- [20] G. Miermont. The Brownian map is the scaling limit of uniform random plane quadrangulations. *Acta Mathematica*, 210(2):319–401, 2013. URL <http://arxiv.org/abs/1104.1606>.
- [21] Grégory Miermont. On the sphericity of scaling limits of random planar quadrangulations. *Electron. Commun. Probab.*, 13:248–257, 2008.
- [22] Jason Miller and Scott Sheffield. Quantum loewner evolution. arXiv:1312.5745 [math.PR], 2014.
- [23] J. R. Norris. *Markov chains*, volume 2 of *Cambridge Series in Statistical and Probabilistic Mathematics*. Cambridge University Press, Cambridge, 1998.
- [24] Oded Schramm. Square tilings with prescribed combinatorics. *Israel J. Math.*, 84(1-2):97–118, 1993.
- [25] Oded Schramm. Conformally invariant scaling limits: an overview and a collection of problems. In *International Congress of Mathematicians. Vol. I*, pages 513–543. Eur. Math. Soc., Zürich, 2007. URL <http://arxiv.org/abs/math/0602151>.
- [26] Scott Sheffield. Conformal weldings of random surfaces: SLE and the quantum gravity zipper. arXiv:1012.4797 [math.PR], 2010.
- [27] W. T. Tutte. A census of planar maps. *Canad. J. Math.*, 15:249–271, 1963. URL <http://cms.math.ca/10.4153/CJM-1963-029-x>.

DEPARTMENT OF MATHEMATICS AND STATISTICS, MCGILL UNIVERSITY, 805 SHERBROOKE STREET WEST, MONTRÉAL, QUÉBEC, H3A 2K6, CANADA

E-mail address: louigi.addario@mcgill.ca

URL: <http://www.math.mcgill.ca/~louigi/>

DEPARTMENT OF MATHEMATICS AND STATISTICS, MCGILL UNIVERSITY, 805 SHERBROOKE STREET WEST, MONTRÉAL, QUÉBEC, H3A 2K6, CANADA

E-mail address: nicholas.leavitt@mail.mcgill.ca