

tt^* Geometry in 3 and 4 Dimensions

Sergio Cecotti,[§] Davide Gaiotto,[†] Cumrun Vafa^{*}

[§]*International School of Advanced Studies (SISSA), via Bonomea 265, 34136 Trieste, Italy*

[†]*Perimeter Institute for Theoretical Physics, Waterloo, Ontario, Canada N2L 2Y*

^{*}*Jefferson Physical Laboratory, Harvard University, Cambridge, MA 02138, USA*

ABSTRACT: We consider the vacuum geometry of supersymmetric theories with 4 supercharges, on a flat toroidal geometry. The 2 dimensional vacuum geometry is known to be captured by the tt^* geometry. In the case of 3 dimensions, the parameter space is $(T^2 \times \mathbb{R})^N$ and the vacuum geometry turns out to be a solution to a generalization of monopole equations in $3N$ dimensions where the relevant topological ring is that of line operators. We compute the generalization of the 2d cigar amplitudes, which lead to $S^2 \times S^1$ or S^3 partition functions which are distinct from the supersymmetric partition functions on these spaces, but reduce to them in a certain limit. We show the sense in which these amplitudes generalize the structure of 3d Chern-Simons theories and 2d RCFT's. In the case of 4 dimensions the parameter space is of the form $(T^3 \times \mathbb{R})^M \times T^{3N}$, and the vacuum geometry is a solution to a mixture of generalized monopole equations and generalized instanton equations (known as hyper-holomorphic connections). In this case the topological rings are associated to surface operators. We discuss the physical meaning of the generalized Nahm transforms which act on all of these geometries.

Contents

1	Introduction	2
2	Review of tt^* geometry in 2 dimensions	4
2.1	Brane amplitudes	10
3	Extended tt^* geometries and hyperholomorphic bundles	15
3.1	A basic example of 2d periodic tt^* geometry	21
3.1.1	tt^* metric	21
3.1.2	The amplitude $\langle D_a \phi(x) \rangle = \langle D_a 0 \rangle_x$	24
3.1.3	The limit $\bar{\mu} \rightarrow 0$ and brane identification	26
3.2	A richer example	28
3.3	Some doubly-periodic examples	29
3.4	Non-commutative tt^* geometries	30
3.4.1	tt^* geometry for the models (3.71)(3.75)	32
4	Spectral Lagrangian manifolds	35
4.1	Ordinary models	35
4.2	Periodic models	36
4.3	Doubly-periodic models	38
4.4	Action of $\mathrm{Sp}(2m, \mathbb{A})$ on the spectral manifolds	38
4.5	A higher dimensional perspective	41
4.6	Generalized Nahm's transform and the tt^* geometry	42
4.7	An explicit example	45
4.8	Review of the flat Nahm transform in $\mathbb{R}^{4n-k} \times T^k$	47
4.9	Some examples from D-branes	48
5	tt^* geometry in 3 dimensions	50
5.1	The parameter space	50
5.2	Derivation of 3d tt^* geometry from 2d perspective	52
5.3	Chiral algebra and line operators	53
5.4	Geometry of T^2 and partition functions on elongated $S^2 \times S^1$ and S^3	53
5.5	Partition functions as gauge transformations	59
5.6	Massive limits and topological line operator algebra	61
5.7	Generalities of 3d brane amplitudes	63
5.8	Comparison with susy partition functions on $S^2 \times S^1$ and S_b^3	64

6	Examples of tt^* geometry in 3 dimensions	65
6.1	Free 3d chiral multiplet	66
6.1.1	Evaluation of the elongated S^3 partition function $Z_{S^3} = S_{00}$	69
6.1.2	Branes for the 3d free chiral theory	70
6.1.3	The $\zeta = \pm 1$ amplitudes and the S -gauge transformation	73
6.2	The $\mathbb{C}P_0^1$ sigma model	74
6.3	Main Example: Codimension 2 Defects	76
6.4	Loop operator algebras as deformed Verlinde Algebra	84
6.5	Class R three-dimensional theories associated to three-manifolds	85
7	tt^* geometry in 4 dimensions	86
7.1	The case of flavor symmetries	86
7.2	The case of 2-form symmetries	87
7.3	Partition functions on elongated $S^3 \times S^1$ and $S^2 \times T^2$	88
7.4	Gauging and ungauging	89
8	Examples of tt^* geometry in 4 dimensions	90
8.1	SQCD	96
8.2	4d probes of more general 6d (1,0) SCFT's	97
9	Line operators and the CFIV index	100
9.1	CFIV index and 3d theories	101
9.2	Possible interpretations of Q in terms of line operators	102
9.3	On the CFIV index for the 3d chiral model	103
9.4	General 3d $\mathcal{N} = 2$ models: large mass asymptotics	107
A	Proofs of identities used in §.3.1	109
A.1	Eqns.(3.55) and (3.56)	109
A.2	The asymmetric UV limit $\bar{\mu} \rightarrow 0$	110
A.2.1	$\log \Pi(x, \mu, 0)$ for $x \in \frac{1}{2}\mathbb{Z}$	110
A.2.2	Kummer formula	112
A.2.3	The $\zeta = 1$ thimble brane function $\Phi(x, \mu, \bar{\mu})$ for $\text{Re } \mu \geq 0$	112
A.2.4	The limit $\bar{\mu} \rightarrow 0$ of Π in the negative half-plane	113
A.3	Explicit expressions for the CFIV new susy index	114
B	Technicalities for the 3d chiral (§.6.1)	115
B.1	Details on the tt^* metric for the 3d free chiral multiplet	115
B.2	The asymmetric UV limit for the 3d brane amplitudes	117

1 Introduction

Supersymmetric quantum field theories are rich with exactly computable quantities. These have various degrees of complexity and carry different information about the underlying supersymmetric theory. Recently many interesting amplitudes have been computed on S^d or $S^{d-1} \times S^1$ for various dimensions and for theories with various amounts of supersymmetry. These geometries are particularly relevant for the conformal limit of supersymmetric theories, where conformal transformations can flatten out the spheres. Away from the conformal fixed point, one can still formulate and compute these supersymmetric partition functions, but this involves adding unphysical terms to the action to preserve the supersymmetry, which in particular are not compatible with unitarity.

It is natural to ask whether away from conformal points one can compute supersymmetric amplitudes without having had to add unphysical terms to the action, and in particular study non-trivial amplitudes in flat space. A prime example of this would be studying the geometry of the supersymmetric theory on flat toroidal geometries. In particular we can consider T^{d-1} flat torus as the space, with periodic boundary conditions for supercharges. Supersymmetric theories have a number N of vacua and in this context one can ask what is the geometry of the Berry's $U(N)$ connection of the vacuum states as a function of parameters of the underlying theory. This question has been answered in the case of 2 dimensions for theories with $(2, 2)$ supersymmetry which admit deformations with mass gap [1] leading to what is called the tt^* geometry. The equations characterizing $U(N)$ connection on the k -complex dimensional parameter space are known as the tt^* equations. In the case $k = 1$ these reduce to $U(N)$ Hitchin equations, which in turn can be viewed as the reduction of self-dual Yang-Mills equations from 4 to 2 dimensions.

It is natural to try to generalize these results to supersymmetric theories in higher dimensions which admit mass gap. The interesting theories, by necessity, would have up to 4 supercharges: they would include in 3 dimensions the $\mathcal{N} = 2$ theories and in 4 dimensions the $\mathcal{N} = 1$ supersymmetric models.¹ Some evidence that such a generalization should be possible, at least in the case of $\mathcal{N} = 2$, $d = 3$, has been found in [2, 3]. The strategy to determine the higher dimensional tt^* geometries is rather simple: We can view their toroidal compactification as a 2d theory with infinitely many fields. Therefore the tt^* equations also apply to these theories as well. The S^1 and T^2 compactifications of three and four-dimensional gauge theories gives 2d theories analogous to (infinite dimensional) gauged linear sigma models with twisted masses. These 2d theories have infinitely many vacua similar to the $|n\rangle$ vacua of QCD. It is natural to consider the analog of $|\theta\rangle$ vacua which corresponds to turning

¹Our considerations also apply to d -dimensional half-BPS defects in $(d + 2)$ -dimensional field theories with eight supercharges

on twists by flavor symmetries as we go around the tt^* compactification circle. These extra parameters lead to tt^* equations formulated on a higher dimensional space.

In the case of $d = 3$ the equations capturing the tt^* geometry live in the $3r$ dimensional space $(T^2 \times \mathbb{R})^r$, where r is the rank of flavor symmetry. This space arises by choosing $2r$ flavor symmetry twists around the cycles of T^2 and r twisted masses associated to flavor symmetries. In the case of $r = 1$ the tt^* equations coincide with the Bogomolny monopole equations, which can be viewed as the reduction of self-dual Yang-Mills from 4 to 3 dimensions. The more general $r \geq 1$ case can be viewed as a generalization of monopole equations to higher dimensions. The chiral operators of the 2d theory lift to line operators of the 3d theory.

Similarly one can consider $\mathcal{N} = 1$ theories in $d = 4$. In this case, if the flavor symmetry has rank r , the tt^* parameter space will be T^{3r} , corresponding to the $3r$ twist parameters for the flavor symmetry, where T^r can be viewed as the Cartan torus of the flavor group. In this case the tt^* equations are again a generalization of monopole equations but now triply periodic. If, in addition, we have m $U(1)$ gauge symmetries² the parameter space has an extra factor $(T^3 \times \mathbb{R}^1)^m$ corresponding to turning on $3m$, $\int B_i \wedge F_i$ type terms and m FI-parameters. In the case of $m = 1$ the tt^* equations are the self-dual Yang-Mills equations. For higher m they describe hyper-holomorphic connections (or certain non-commutative deformations of them). These are connections which are holomorphic in any choice of complex structure of the hyper-Kähler space $T^{3m} \times \mathbb{R}^m$. In fact the generalized monopole equations or the original 2d tt^* equations can be viewed as reductions of the hyper-holomorphic structure from $4m$ dimensions to $3m$ or $2m$ dimensions, respectively. Then the hyperholomorphic geometry is a unified framework for all tt^* geometries. The chiral operators of 2d theory lift to surface operators of the 4d theory.

There are also operations that one can do on quantum field theories. In particular, we can gauge a flavor symmetry or ungauged a gauge symmetry. More generally, we consider extensions of these actions on the space of field theories to $\mathrm{Sp}(2g, \mathbb{C})$ actions on $2d$ theories with $(2, 2)$ supersymmetry or $\mathrm{Sp}(2g, \mathbb{Z})$ actions on $3d$ theories [4] with $\mathcal{N} = 2$ supersymmetry. At the level of the tt^* geometry, as we shall show, these turn out to correspond to generalized Nahm transformations on the space of hyper-holomorphic connections or their reductions.

The derivation of tt^* equations for the vacuum geometry in 2 dimensions involved studying topologically twisted theories on cigar or stretched S^2 geometries. It is natural to ask what is the relation of this to supersymmetric partition functions on S^2 . It has been shown recently [52, 53] that in the case of conformal theories they are the same, but in the case of the mass deformed ones, they differ, and the tt^* amplitude is far more complicated. We explain in this paper how one can recover

²The tt^* geometry is independent of the 4d gauge couplings, and unaffected by the Landau pole. Later in the paper, we will also show how the Landau pole can be avoided by appropriate UV completions which do not modify the tt^* geometry itself

the supersymmetric partition functions from the tt^* amplitudes by taking a particular limit.

For the case of the 3 dimensional theories, one can still define and compute the amplitudes on stretched $S^2 \times S^1$ or S^3 (depending on how we fill the T^2 on either side). These involve some novel ideas which are not present in the case of 2d tt^* geometry. In particular the realization of modular transformations on T^2 as gauge transformations on the tt^* geometry plays a key role and gives rise to the S^3 partition function. Moreover the line operators inserted on the two ends of S^3 give rise to a matrix which is a generalization of the S -matrix for the $\tau \rightarrow -1/\tau$ modular transformation of rational conformal field theories in 2d, while the line operator ring plays the role of the Verlinde algebra [48]. In fact in special IR limits the 3d theory typically reduces to a product of topological Chern-Simons theories in 3d and in this case the tt^* S -matrix reduces to the usual S -matrix of 2d RCFT's as was shown in [44]. Thus the tt^* geometry gives an interesting extension of the Verlinde structure which includes UV degrees of freedom of the theory. We show that, just as in the 2d case, these partition functions agree with the supersymmetric partition functions on S_b^3 and $S^2 \times S^1$ at the conformal point, but differ from them when we add mass terms. The tt^* partition functions are more complicated functions but in a certain limit, these partition functions reduce to the supersymmetric partition functions. Similarly, one can extend these ideas to the 4d theory and compute tt^* partition functions on the elongated spaces $S^2 \times T^2$ and $S^3 \times S^1$.

The plan of this paper is as follows: In section 2 we review the tt^* geometry in 2 dimensions. In section 3 we show how this can be extended to the cases where flavor symmetries give rise to infinitely many vacua, and how the monopole equations, self-dual Yang-Mills equations, and more generally the hyper-holomorphic connections can arise. In section 4 we introduce the notion of an $\mathrm{Sp}(2g, \mathbb{A})$ action on these QFTs, which changes the theory, and show how this transformation acts on the tt^* geometry as generalized Nahm transformations. In section 5 we apply these ideas to 3 dimensional $\mathcal{N} = 2$ theories. In section 6 we give examples of the tt^* geometry in 3 dimensions. In section 7 we study the case of tt^* geometry for $\mathcal{N} = 1$ theories in 4d. In section 8 we give some examples in the 4d case. In section 9 we take a preliminary step for the interpretation of the CFIV index [23] as applied to higher dimensional theories and in particular to $d = 3$. Some of the technical discussions are postponed to the appendices.

2 Review of tt^* geometry in 2 dimensions

In this section we review tt^* geometry in 2 dimensions [1]. We consider $(2, 2)$ supersymmetric theories in 2 dimensions which admit supersymmetric deformations which introduce a mass gap and preserve an $SO(2)_R$ charge. The deformations of these

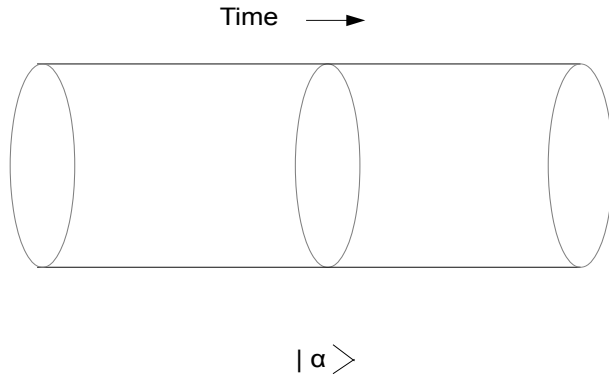

Figure 1: 1+1 dimensional geometry with circle of length β as the space and vacuum $|\alpha\rangle$.

theories are divided to superspace type deformations, involving F-terms, and D-term variations.³ The D-term variations are known not to affect the vacuum geometry, and so we will not be interested in them. The F-term deformation space is a complex space with complex coordinates t^i , whose tangent is parameterized by chiral fields Φ_i and correspond to deformations of the theory by F-terms

$$\int d^2\theta d^2z \delta W + c.c. = \int d^2\theta d^2z \delta t_i \Phi^i + c.c.$$

The chiral operators form a commutative ring:

$$\Phi_i \Phi_j = C_{ij}{}^k \Phi_k,$$

and similarly for the anti-chiral operators:

$$\bar{\Phi}_i \bar{\Phi}_j = \bar{C}_{ij}{}^k \bar{\Phi}_k.$$

The $C_{ij}{}^k$ are only a function of t^i and $\bar{C}_{ij}{}^k$ are only a function of \bar{t}^i .

Consider the theory on a circle with supersymmetric periodic boundary conditions for fermions. Let $|\alpha\rangle$ denote the ground states of the theory (see Fig. 1). As we change the parameters of the theory the ground states vary inside the full Hilbert space of the quantum theory. Let us denote this by $|\alpha(t, \bar{t})\rangle$. Then we can define Berry's connection, as usual, by⁴

$$\frac{\partial}{\partial t^i} |\alpha(t, \bar{t})\rangle = (A_i)_{\alpha}^{\beta} |\beta(t, \bar{t})\rangle$$

³There may be twisted F-term deformations as well, but for our purposes they behave as D-term deformations

⁴ Here and in the following equations, equalities of states signify equalities up to projection onto the ground state subsector.

$$\frac{\partial}{\partial \bar{t}^i} |\alpha(t, \bar{t})\rangle = (\bar{A}_i)_\alpha^\beta |\beta(t, \bar{t})\rangle.$$

It is convenient to define covariant derivatives D_i, \bar{D}_i by

$$D_i = \partial_i - A_i \quad \bar{D}_i = \bar{\partial}_i - \bar{A}_i$$

In other words over the moduli space of the theory, parameterized by t_i we naturally get a connection of rank N bundle where N denotes the number of vacua of the $(2, 2)$ theory.⁵ Note that the length of the circle where we consider the Hilbert space can be chosen to be fixed, say 1, and the radius dependence can be obtained by the RG flow dependence of the parameters of the theory. For $(2, 2)$ theories this corresponds to

$$W \rightarrow \beta W \tag{2.1}$$

where β is the length of the circle.

The ground states of the theory form a representation of the chiral ring:

$$\Phi_i |\alpha\rangle = (C_i)_\alpha^\beta |\beta\rangle$$

and similarly for $\bar{\Phi}_i$. It turns out that there are two natural bases for the vacua, which are obtained as follows: Since the $(2, 2)$ theory enjoys an $SO(2)$ R-symmetry, one can consider a topological twisted version of this theory [5]. In particular we consider a cigar geometry with the topological twisting on the cigar. We consider a metric on the cigar which involves a flat metric sufficiently far away from the tip of the cigar. The topologically twisted theory is identical to the physical untwisted theory on flat space. Path-integral determines a state in the physical Hilbert space. We next consider the limit where the length of the cigar $L \rightarrow \infty$. In this limit the path-integral projects the state to a ground state of theory. Since chiral operators are among the BRST observables of the topologically twisted theory, we can insert them anywhere in the cigar and change the state we get at the boundary. Consider the path-integral where Φ_i is inserted at the tip of the cigar. The resulting ground state will be labeled by $|i\rangle$ (see Fig. 2).

In particular there is a distinguished state among the ground states when we insert no operator (or equivalently when we insert the ‘chiral field’ 1 at the tip of the cigar) which we denote by $|0\rangle$. In this basis of vacua, the action of the Φ_i coincides with the ring coefficients:

$$\Phi_i |j\rangle = C_{ij}^k |k\rangle$$

In other words $(C_i)_j^k = C_{ij}^k$. Note that

$$|i\rangle = \Phi_i |0\rangle.$$

⁵ We have enough supersymmetry to guarantee that the number of vacua does not change as we change the parameters of the theory.

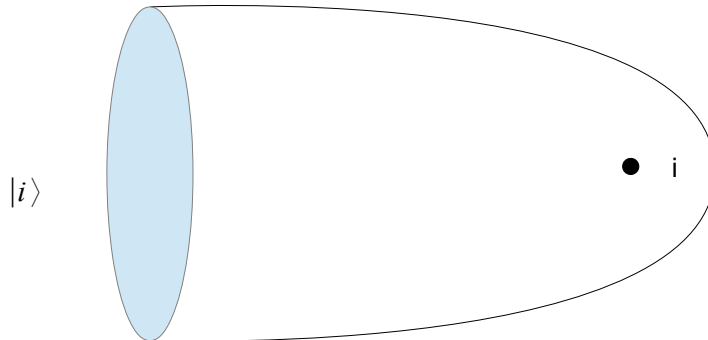

Figure 2: A holomorphic basis for states can be produced by topologically twisted path-integral on an infinitely long cigar, with chiral fields inserted at the tip of the cigar.

Moreover this basis for the vacuum bundle exhibits the holomorphic structure of the bundle. Namely, in this basis $(A_{\bar{i}})_j^k = 0$. Similarly, when we topologically twist in a complex conjugate way, we get a distinguished basis of vacua corresponding to anti-chiral fields $|\bar{i}\rangle$. These form an anti-holomorphic section of the vector bundle for which $(A_i)_{\bar{j}}^{\bar{k}} = 0$.

Given these two distinguished bases for the ground states, it is natural to ask how they are related to one another. One defines

$$\eta_{ij} = \langle i|j\rangle \quad g_{i\bar{j}} = \langle \bar{j}|i\rangle$$

and similarly for the complex conjugate quantities. η is a symmetric pairing and it can be formulated purely in terms of the topologically twisted theory on the sphere (see Fig. 3). It only depends on holomorphic parameters. It is convenient (and possible) to choose a basis for chiral fields such that η is a constant matrix.

On the other hand, g is a hermitian metric depending on both t and \bar{t} and is far more complicated to compute. It can be formulated as a path integral on a sphere composed of two cigars connected to one another, where we do topological twisting on one side and anti-topological twisting on the other side. Furthermore we take the limit in which the length of the cigar goes to infinity. For any finite length of the cigar the path integral does not preserve any supersymmetry, and it is crucial to take the $L \rightarrow \infty$ to recover a supersymmetric amplitude (see Fig. 4).

Note that the holomorphic and anti-holomorphic bases span the same space so they are related by a matrix M :

$$|\bar{i}\rangle = M_{\bar{i}}^j |j\rangle.$$

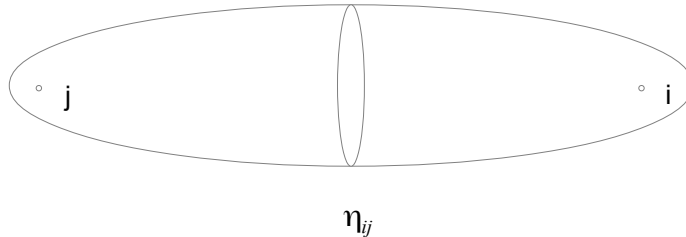

Figure 3: The topologically twisted two point function η_{ij} can be computed by topologically twisted path-integral on S^2 , where we insert the chiral operators on the two ends of the sphere. The path-integral respects supersymmetry for arbitrary choice of metric on S^2 .

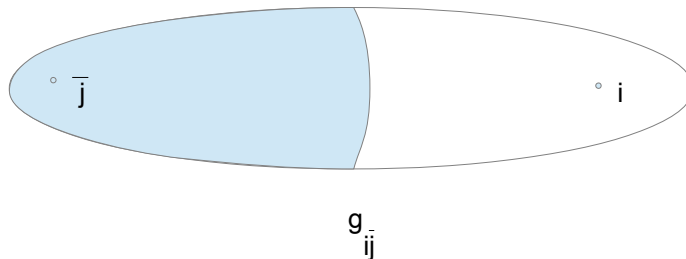

Figure 4: The hermitian metric, which is induced from the hermitian inner product on the Hilbert space in the ground states of the theory can be obtained by path-integral on an infinitely elongated S^2 where on one half we have a topologically twisted theory with chiral fields inserted and on the other the anti-topological twisted theory with anti-chiral fields inserted.

M can be computed in terms of g, η as

$$M = \eta^{-1}g.$$

Furthermore, since M represents the CTP operator acting on the ground states we must have $MM^* = 1$; this implies that

$$(\eta^{-1}g)(\eta^{-1}g)^* = 1. \tag{2.2}$$

Since g is the usual inner product in the Hilbert space, it is easy to see that it is covariantly constant with respect to the connections we have introduced:

$$D_i g_{k\bar{l}} = \partial_i g_{k\bar{l}} - A_{ik}^j g_{j\bar{l}} - A_{i\bar{l}}^{\bar{j}} g_{k\bar{j}} = 0 = \bar{D}_i g.$$

The tt^* geometry gives a set of equations which characterize the curvature of the vacuum bundle. They are given by

$$\begin{aligned} [\bar{D}_i, C_j] &= 0 = [D_i, \bar{C}_j] \\ [D_i, D_j] &= 0 = [\bar{D}_i, \bar{D}_j] \\ [D_i, C_j] &= [D_j, C_i] \quad [\bar{D}_i, \bar{C}_j] = [\bar{D}_j, \bar{C}_i] \end{aligned}$$

Furthermore the non-vanishing curvature of the Berry's connection is captured by the equations

$$[D_i, \bar{D}_j] = -[C_i, \bar{C}_j]$$

These equations can be summarized as the flatness condition for the following family of connections parameterized by a phase $\zeta = e^{i\alpha}$. Consider

$$\nabla_i = D_i + \zeta C_i \quad \bar{\nabla}_i = \bar{D}_i + \zeta^{-1} \bar{C}_i \quad (2.3)$$

The tt^* equations can be summarized by the condition of flatness of ∇^α and $\bar{\nabla}^\alpha$:

$$[\nabla_i, \nabla_j] = [\bar{\nabla}_i, \bar{\nabla}_j] = [\nabla_i, \bar{\nabla}_j] = 0$$

for arbitrary phase α , and in fact for all complex numbers $\zeta \in \mathbb{C}^*$. Note that on top of these equation we have to impose the reality structure given by $MM^* = 1$, as an additional constraint.

We shall refer to the flat connection (2.3) as the tt^* *Lax connection* (with spectral parameter ζ). It is also known as the tt^* Gauss–Manin connection.

For the case of one variable, the tt^* equations become equivalent to the Hitchin equations [6], which itself is the reduction of instanton equations from 4 dimensions to 2 dimensions. In that context, if we represent the flat 4d space by two complex coordinates (t, u) and reduce along u the system on t space will become the tt^* system:

$$\begin{aligned} A_{\bar{u}} &\leftrightarrow C \\ A_u &\leftrightarrow -\bar{C} \end{aligned}$$

in which case the two non-trivial parts of the tt^* read as

$$\begin{aligned} [\bar{D}, C] &= F_{\bar{t}\bar{u}} = 0 = F_{tu} = [D, \bar{C}] \\ F_{\bar{t}\bar{t}} &= [D, \bar{D}] = -[C, \bar{C}] = -F_{u\bar{u}}. \end{aligned}$$

Thus tt^* geometry with more parameters can be viewed as a dimensional reductions of a generalization of instanton equations. As we will discuss later, and will be relevant for the generalizations of tt^* geometry to higher dimensions, the more general case can be viewed as a reduction of tri-holomorphic connections on hyperKähler manifolds.

The massive $(2, 2)$ theories we consider will typically have a set of massive vacua in infinitely long space⁶, say corresponding to the critical points of the superpotential in a LG theory. In the topological gauge, the matrices C_i are independent of the length β of the compactification circle, and thus can be computed in terms of the properties of the theory on flat space.

More precisely, the eigenvalues $p_{i,a}$ of the C_i matrices should correspond to the vevs of the corresponding chiral operators Φ_i in the various massive vacua of the theory in flat space. In turn, these vevs can be expressed in terms of the low energy effective superpotentials $W^{(a)}[t_i]$ in each vacuum a of the theory in flat space:

$$p_{i,a} = \partial_{t_i} W^{(a)} \tag{2.4}$$

In a LG theory, the $W^{(a)}$ coincide with the values of the superpotential at the critical points.

Although solving the tt^* equations is generally hard, the solutions can be readily labelled by holomorphic data, as will be discussed in section 4, by trading in the usual way the $[D, D] = [C, C]$ equation for a complexification of the gauge group. Then the solution is labelled by the higher dimensional Higgs bundle defined by the pair \overline{D}_i and C_i . For generic values of the parameters $t_i \in \mathcal{T}$ we can simultaneously diagonalize the C_i , and encode them into the Lagrangian submanifold \mathcal{L} in $T^*\mathcal{T}$ defined by the pair (t_i, p_i) . The corresponding eigenline defines a line bundle L on \mathcal{L} . The pair (\mathcal{L}, L) gives the spectral data which labels a generic solution of the tt^* equations. For one-dimensional parameter spaces, this is the standard spectral data for a Hitchin system on \mathcal{T} . We refer to section 4 for further detail and generalizations.

2.1 Brane amplitudes

The flat sections of the Lax connection over the parameter space have a physical interpretation that will be important for us [1, 7, 11]. The mass-deformed $(2, 2)$ theory may admit supersymmetric boundary conditions (“D-branes”). Consider in particular some half-BPS boundary conditions which also preserve $SO(2)_R$. There is a certain amount of freedom in picking which two supercharges will be preserved by the boundary condition. The freedom is parameterized by a choice of a phase given by a complex number ζ with norm 1. Roughly, if we denote the $(2, 2)$ supercharges as $Q_{L,R}^\pm$, where L, R denote left- or right-moving, and \pm the R-charge eigenvalue, a brane will preserve

$$Q_L^+ + \zeta Q_R^+ \quad Q_L^- + \zeta^{-1} Q_R^-. \tag{2.5}$$

A given half-BPS boundary condition D in massive $(2, 2)$ theories is typically a member of a 1-parameter family of branes D^ζ which preserve different linear combinations of supercharges. We will usually suppress the ζ superscript.

⁶ Not to be confused with the states $|\alpha\rangle$ on the circle of finite length β .

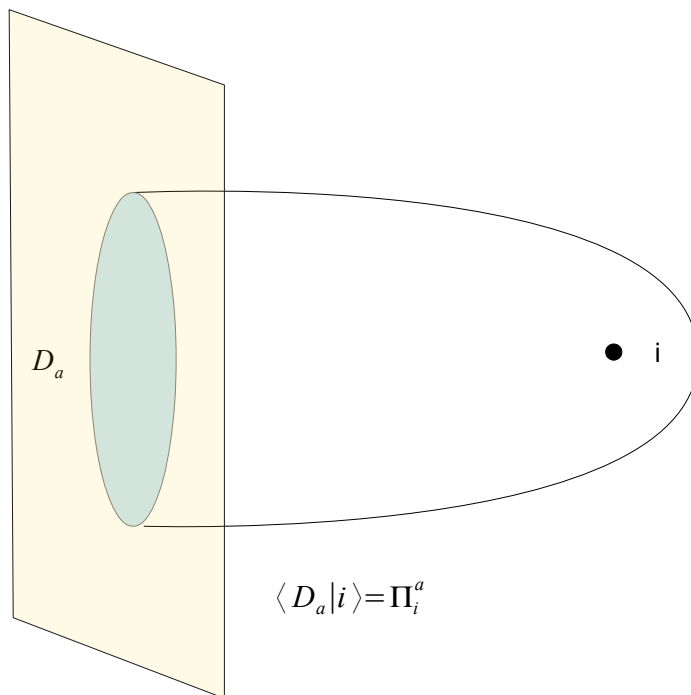

Figure 5: The overlap of the vacuum states with the D-branes give rise to Π_i^a which are flat sections of the improved tt^* connection.

We can use a brane D to define states $|D\rangle$ or $\langle D|$ in the Hilbert space for the theory on a circle, even though this state will not be normalizable, as is familiar in the context of D-brane states. We can project the states onto the supersymmetric ground states, i.e. we consider inner products such as

$$\Pi[D, \zeta] = \langle D | \alpha \rangle.$$

Such a “brane amplitude” is a flat section of the tt^* Lax connection with spectral parameter ζ [11].

It is useful to consider the brane amplitudes in the holomorphic gauge

$$\Pi_i = \langle D | i \rangle$$

which can be defined by a topologically twisted partition function on the semi-infinite cigar (see Fig. 5).

We can also define

$$\hat{\Pi}_i[D] = \langle i | D \rangle$$

Looking at the BPS conditions, one notices that the “same” boundary condition can be used to define a left boundary condition of parameter ζ or a right boundary condition of parameter $-\zeta$. Thus $\hat{\Pi}_i[D]$ is a left flat section for the tt^* Lax connection of spectral parameter $-\zeta$. Using CTP, we can see

$$\langle \bar{i} | D \rangle = \Pi_{\bar{i}}^\dagger[D] \quad \langle D | \bar{i} \rangle = \hat{\Pi}_{\bar{i}}^\dagger[D].$$

This is consistent with the observation that if ζ is a phase, the hermitean conjugate of standard flat section for the Lax connection of parameter ζ is a left flat section for the Lax connection of parameter $-\zeta$.⁷

For simplicity we will limit our discussion here to the case of (2,2) Landau-Ginzburg models, characterized by some superpotential W . The vacua are in one to one correspondence with critical points of W . In the LG case there is a particularly nice class of branes [11], represented by special mid-dimensional Lagrangian subspaces in field space sometimes called ‘‘Lefschetz thimbles’’, which are defined as contours of steepest descent for an integral of $e^{-\zeta W}$. They have the property that the value of the superpotential W on that subspace is on a straight line, emanating from the critical value, with slope given by the phase ζ (see Fig. 6).⁸

Let a denote a critical point of W . The corresponding D-brane emanating from it will be denoted by D_a . Note that the D_a are piece-wise continuous as a function of ζ , with jumps at special values of ζ which are closely related to the BPS spectrum of the theory. We will denote the corresponding brane amplitudes as Π_i^a .

The thimbles D_a defined at ζ and U_a defined at $-\zeta$ form a dual basis of Lagrangian cycles, and the inner product between the corresponding states is given by

$$\langle D_a | U_b \rangle = \delta_{ab}$$

Note that since there are as many $|D_a\rangle$ as the ground state vacua, we can use them to compute the ground state inner products, using the decomposition $1 = \sum_a |U_a\rangle \langle D_a|$, which is valid acting on the ground states:

$$\begin{aligned} \eta_{ij} &= \langle j | i \rangle = \sum_a \langle j | U_a \rangle \langle D_a | i \rangle = \hat{\Pi}_j^a \Pi_i^a \\ g_{i\bar{j}} &= \langle \bar{j} | i \rangle = \sum_a \langle \bar{j} | U_a \rangle \langle D_a | i \rangle = \Pi_j^{a\dagger} \Pi_i^a \end{aligned} \tag{2.6}$$

The thimble brane amplitudes $\Pi^a = \Pi[D_a]$ give a fundamental basis of flat sections for the tt^* Lax connection [7, 21]. Any other brane amplitude can be rewritten as a linear combination

$$\Pi[D] = \sum_a n_a[D] \Pi^a \tag{2.7}$$

with integer coefficients n_a which coincide with the framed BPS degeneracies defined in [21] and can be computed as $\langle D | U^a \rangle$.

The brane amplitudes $\Pi[D, \zeta]$ can be analytically continued to any value of ζ in (the universal cover of) \mathbb{C}^* so that $\Pi[D, \zeta]$ is holomorphic in ζ . The general analysis

⁷ For general ζ , that would be $-\bar{\zeta}^{-1}$.

⁸The D-branes introduced in [11] project to straight-lines on W -plane. This can be relaxed to D-branes that at the infinity in field space approach straight lines and are more relaxed in the interior regions [13]. In this paper we will not need this extension and take the D-branes simply to project to the straight lines in W -plane.

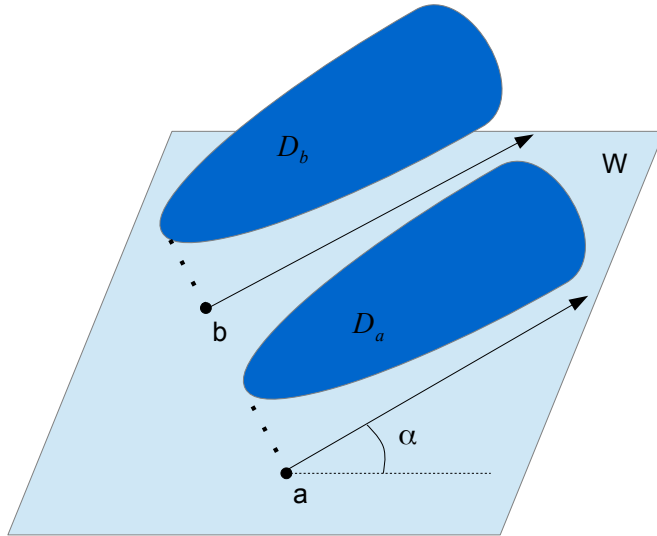

Figure 6: D-branes in the LG description of $(2, 2)$ theories are Lagrangian submanifolds which project to straight lines in the W -plane emanating from critical points of W . These objects are also known as ‘Lefschetz thimble branes’. The slope α determines the combination of supercharges which the D-brane preserves. In the massive phases there is one D-brane per vacuum (and angle α).

of [7, 21] shows that $\Pi[D, \zeta]$ will have essential singularities at $\zeta = 0$ and $\zeta = \infty$, with interesting Stokes phenomena associated to the BPS spectrum of the theory.

It is clear from the form of the Lax connection and of the eigenvalues $p_{i,a}$ of C_i that the asymptotic behaviour as $\zeta \rightarrow \infty$ of a flat section should be

$$\Pi[D, \zeta] \sim \sum_a e^{-\zeta W^{(a)}} v_a \quad (2.8)$$

where v_a are simultaneous eigenvectors of the C_i .

The thimble brane amplitudes have the very special property that $\Pi^a \sim e^{-\zeta W^{(a)}}$ for the analytic continuation of $\Pi^a[\zeta]$ to a whole angular sector of width π around the value of ζ at which the thimbles are defined. This property, together with the relation between the jumps of the basis of thimble branes as we vary the reference value of ζ and the BPS spectrum of the theory [11] allow one to reconstruct the $\Pi^a[\zeta]$ from their discontinuities by the integral equations described in [7, 21].

Although a full review of these facts would bring us too far from the purpose of this paper, these is a simplified setup which captures most of the structure and will be rather useful to us. The tt^* geometry has a useful ‘conformal limit’, $\beta \rightarrow$

0. Although in this limit one would naively expect the dependence on relevant deformation parameters t_i, \bar{t}_i to drop out, the behaviour of the brane amplitudes as a function of β, ζ is somewhat more subtle.

More precisely, if we look at $\Pi_i[\zeta]$ and focus our attention on the region of large ζ , *i.e.* we keep $\zeta\beta$ finite as $\beta \rightarrow 0$, only the \bar{t}_i dependence really drops out and we are left with interesting functions of the holomorphic parameters t_i . The converse is true for the amplitudes $\Pi_{\bar{i}}[\zeta] = \langle D|\bar{i} \rangle$ in the anti-holomorphic gauge, for finite $\zeta^{-1}\beta$.

In the LG case they are given by period integrals [11]

$$\begin{aligned}\Pi_i &= \int_D \Phi_i \exp\left(-\zeta\beta W(X^\alpha, t)\right) dX^1 \wedge \cdots \wedge dX^n \\ \Pi_{\bar{i}} &= \int_D \bar{\Phi}_i \exp\left(-\zeta^{-1}\beta \bar{W}(\bar{X}^\alpha, \bar{t})\right) d\bar{X}^1 \wedge \cdots \wedge d\bar{X}^n,\end{aligned}$$

where, for later convenience, we reintroduced the explicit dependence on the S^1 length β , see eqn.(2.1). The flatness under the tt^* Lax connection reduces to the obvious facts that

$$\partial_{t_j}\Pi_i + \beta\zeta C_{ij}^k \Pi_k = 0 \quad \partial_{\bar{t}_j}\Pi_i = 0 \quad (2.9)$$

Due to the relation between thimble Lagrangian manifolds and steepest descent contours, it is obviously true that the thimble brane amplitudes Π_i^a have the expected asymptotic behaviour at $\zeta \rightarrow \infty$. Furthermore, it is also clear that for an A-brane defined by some Lagrangian submanifold D the integers $n_a[D]$ are simply the coefficients for the expansion of D into the thimble cycles. The Stokes phenomena for the tt^* geometry reduce to the standard Stokes phenomena for this class of integrals.

There is another observation which will be useful later. Let us introduce one additional parameter P_α for each chiral field X^α , deform the superpotential $W \rightarrow W - X^\alpha P_\alpha$, and consider Π^a for this deformed W . We can view P_α as part of the parameter space of W . Let's focus on Π_0^a , *i.e.* the integral without insertion of chiral fields.

$$\Pi_0^a \Big|_{\bar{\beta} \rightarrow 0} = \int_{D_a} \exp\left(-\zeta\beta W(X^\alpha, t) - \zeta\beta X^\alpha P_\alpha\right) dX^1 \wedge \cdots \wedge dX^n.$$

Now consider the insertion of $\partial W/\partial X^\gamma - P_\gamma$ in the above integral, and use integration by parts to conclude its vanishing:

$$\int_{D_a} dX^\alpha \left(\frac{\partial W}{\partial X^\gamma} - P_\gamma\right) \exp\left(-\zeta\beta W(X^\alpha, t) - \zeta\beta X^\alpha P_\alpha\right) = 0$$

Which can be rewritten as

$$\left[\partial_\gamma W\left(-\frac{1}{\zeta}\frac{\partial}{\partial P_\alpha}\right) - P_\gamma\right] \int_{D_a} dX^\alpha \exp\left(-\zeta\beta W(X^\alpha, t) - \zeta\beta X^\alpha P_\alpha\right) = 0.$$

In other words

$$\left[\partial_\gamma W \left(-\frac{1}{\zeta^\beta} \frac{\partial}{\partial P_\alpha} \right) - P_\gamma \right] \Pi_0^a \Big|_{\bar{\beta} \rightarrow 0} = 0. \quad (2.10)$$

Note that, replacing $\zeta^\beta \rightarrow i/\hbar$, the above formula is suggestive of a quantum mechanical system where (X^α, P_α) form the phase space. At this point however, it appears that they are not on the same footing as X^α is a field but P_α is a parameter. In section 4 we will see that we can in fact consider a dual LG system where P_α can be promoted to play the role of fields. More generally we will see that we can have an $\text{Sp}(2g, \mathbb{C})$ transformation where one chooses a different basis in which parameters are promoted to fields. Here g denotes the number of chiral fields. Indeed this structure also appeared for 2d (2,2) theories which arise by Lagrangian D-brane probes of Calabi-Yau in the context of topological strings [10] (which can be interpreted as codimension 2 defects in the resulting 4 or 5 dimensional theories), and the choice of parameters versus fields depends on the boundary data of the Lagrangian brane. We will see that this correspondence is not an accident.

3 Extended tt^* geometries and hyperholomorphic bundles

The basic assumption of the standard tt^* analysis in the previous section is that the F-term deformation parameters t^i are dual to well defined chiral operators of the theory, such as single-valued holomorphic functions on the target manifold \mathcal{M} of a LG model. This is not the only kind of deformation parameter which may appear in the F-terms of the theory. There are more general possibilities which lead to more general tt^* geometries and new phenomena. In this section we discuss mostly situations which give rise to various dimensional reductions of the equations for a hyper-holomorphic connection. We will briefly comment at the end on a more extreme situation in which the tt^* geometry is based on *non-commutative* spaces.

The simplest extension of tt^* is generically associated to the existence of flavor symmetries in the theory. In a mirror setup, where one looks at the twisted F-terms for, say, a gauged linear sigma model, such deformation parameters are usually denoted as twisted masses. If a flavor symmetry is present, which acts on the chiral fields of the GLSM, one can introduce the twisted masses as the vevs of the scalar field in a background gauge multiplet coupled to that flavor symmetry. In the presence of twisted masses, the low-energy twisted effective superpotential for the theory is a multi-valued function over the space of vacua, defined up to integral shifts by the twisted masses.

In the context of LG theories, one can consider a non-simply connected target space \mathcal{M} , and superpotential deformations such that the holomorphic 1-form dW is closed but not exact on \mathcal{M} . The periods of dW over 1-cycles of \mathcal{M} give the “twisted mass” deformation parameters. In order to see the associated flavor symmetry, we can pull the closed 1-form dW to space-time, and thus define a conserved current.

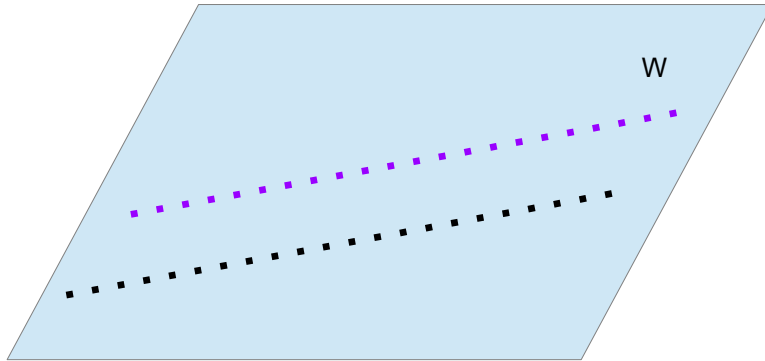

Figure 7: In a 2d theory with one flavor symmetry each vacuum has infinitely many copies linearly shifted in the W -plane by an amount $2\pi i\mu$.

The simplest possibility, which occurs in the mirror of GLSM [12] and appears to be typical for the effective LG descriptions of UV-complete 2d field theories, is modelled on a poly-cylinder: a collection of LG fields with periodicity $Y_a \sim Y_a + 2\pi i n_a$. A superpotential which includes the general linear term $\sum_a \mu_a Y_a$ will have discontinuities

$$W(Y_a + 2\pi i n_a) = W(Y_a) + 2\pi i \sum_a n_a \mu_a, \quad (3.1)$$

with generic values for the complex twisted masses $4\pi i \mu_a$.⁹ We will denote these models as “periodic” (see Fig. 7 for the case of one periodic field).

There is a second possibility which one encounters, for example, for 2d systems which occur as a surface defect in a 4d $\mathcal{N} = 2$ gauge theory [10, 14]: the twisted mass parameters may not be all independent. We can model this occurrence by a LG theory with coordinates valued in an Abelian variety¹⁰,

$$Y_a \sim Y_a + 2\pi i n_a + 2\pi i \Omega_{ab} m_b. \quad (3.2)$$

A superpotential which includes the general linear term¹¹ $\sum_a \mu_a Y_a$ will have discon-

⁹ To understand the normalization, remember the BPS bound $M \geq 2|\Delta W|$.

¹⁰ At this level, it suffices that the Y_a ’s take value in a complex torus of positive algebraic dimension. However, we may always reduce, without loss of generality, to the Abelian variety with the same field of meromorphic functions.

¹¹ This corresponds to the case of dW a holomorphic differential on the Abelian variety. More generally, we may take dW to be a closed *meromorphic* differential. If dW is a meromorphic differential of the second kind [15], eqn.(3.3) remains true with Ω_{ab} replaced by the relevant period matrix Λ_{ab} .

tinuities

$$W(Y_a + 2\pi i n_a + 2\pi i \Omega_{ab} m_b) = W(Y_a) + 2\pi i \sum_a \mu_a \left(n_a + \sum_b \Omega_{ab} m_b \right). \quad (3.3)$$

Thus each twisted mass parameter is associated to two flavor symmetries, whose conserved charges arise from the pull-back of dY_a and $d\bar{Y}_a$. We will denote these models as “doubly-periodic”. For surface defects in 4d systems, the relation takes the form

$$\Delta W = \frac{1}{2} \sum_i \left(n_i a_i[u] + m_i a_i^D[u] \right) \quad (3.4)$$

where u are the Coulomb branch parameters in the bulk 4d theory, (a_i, a_i^D) the Seiberg-Witten periods of the 4d theory, and the two conserved charges are the electric and magnetic charges for the bulk 4d gauge fields.

Periodic tt^* geometries. It was already observed in [1, 7, 21] that the tt^* geometries associated to a standard “twisted mass” deformation will be three-dimensional, rather than two-dimensional. Besides the mass parameters μ_a and $\bar{\mu}_a$, one has an extra angular parameter $\theta_a = 2\pi x_a$. The angle θ_a has a direct physical interpretation: it is the flavor Wilson line parameter which appears when the 2d theory is quantized on a circle.

There is an alternative point of view which is very useful in deriving the tt^* equations for a periodic system. We can make the superpotential single-valued by lifting it to an universal cover $\widetilde{\mathcal{M}}$ of \mathcal{M} . Thus each vacuum i of the original theory is lifted to infinitely many copies (i, n_a) , each associated to a sheet of the universal cover. We can define vacuum Bloch-waves labelled by the angles $\theta_a = 2\pi x_a$ (*i.e.* by the characters of the covering group $\widetilde{\mathcal{M}} \rightarrow \mathcal{M}$)

$$|i; x\rangle = \sum_{n_a} e^{2\pi i n_a x_a} |i; n_a\rangle. \quad (3.5)$$

To describe the tt^* geometry in the μ_a directions we need to compute the action of $\partial_{\mu_a} W$, which is not single-valued. This is simple, as the multi-valuedness of $\partial_{\mu_a} W$ is precisely controlled by the n_a . Let n be the number of vacua in a reference sheet. Let B_a be the $n \times n$ matrix

$$B_a = \text{diag} \left(\partial_{\mu_a} W(Y) \Big|_{\substack{Y=i\text{-th vacuum} \\ \text{in reference sheet}}} \right). \quad (3.6)$$

From eqn.(3.1) we see that, acting on the $|i; n_a\rangle$ basis,

$$C_{\mu_a} = 2\pi i \cdot \mathbf{1} \otimes N_a + B_a \otimes \mathbf{1}, \quad (3.7)$$

where N_a acts by multiplication by n_a . On the Bloch basis (3.5) this becomes the differential operator [1]

$$C_{\mu_a} = \frac{\partial}{\partial x_a} + B_a. \quad (3.8)$$

If we focus on the dependence on a single twisted mass parameter and its angle, we get

$$C_\mu = D_x + i\Phi, \quad \bar{C}_{\bar{\mu}} = -D_x + i\Phi, \quad (3.9)$$

with D_x the anti-Hermitian part of C_μ and $i\Phi$ the Hermitian one, while, writing $\mu = (z + iy)/2$,

$$D_\mu = D_z - iD_y, \quad D_{\bar{\mu}} = D_z + iD_y. \quad (3.10)$$

The tt^* equations become

$$[D_x, D_y] = [D_z, \Phi], \quad \text{and cyclic permutations of } x, y, z, \quad (3.11)$$

which, seeing Φ as an (anti-Hermitian) adjoint Higgs fields, are identified with the Bogomolny monopole equations in \mathbb{R}^3 with coordinates x, y, z .

Finally, we can consider chiral operators which are twist fields for the flavor symmetry. In the LG examples discussed above, they would correspond, say, to exponentials $e^{\sum_a x_a Y_a}$. It should be clear that the action of such a chiral twist operator on a Bloch wave vacuum of parameters x'_a would give a vacuum of parameters $x'_a + x_a$. In particular, this shows that the x_a label the Hilbert space sectors \mathcal{H}_{x_a} in which, as we go around the circle, the fields come back to themselves up to a phase $\exp(2\pi i x_a Q_a)$, where Q_a are the flavor symmetry charges.

Note that, since x_a are characters of a symmetry, the tt^* metric satisfies

$$\langle \bar{i}; x_a | j; y_a \rangle = G(x_a)_{ij} \sum_{k_a} \delta(x_a - y_a - k_a) \quad (3.12)$$

Sometimes we leave the x_a dependence implicit and not bother writing the subscript next to the ket.

Doubly-periodic tt^* geometries. In the doubly-periodic case we have two Bloch angles, $\theta_a = 2\pi x_a$ and $\tilde{\theta}_a = 2\pi w_a$ for every mass parameter μ_a . We can write

$$\begin{aligned} C_{\mu_a} &= \frac{\partial}{\partial x_a} + \Omega_{ab} \frac{\partial}{\partial w_b} + B_a = \frac{\partial}{\partial \lambda_a} + B_a \\ x_a &= \lambda_a + \bar{\lambda}_a \quad w_a = \bar{\Omega}_{ab} \lambda_b + \Omega_{ab} \bar{\lambda}_b \end{aligned} \quad (3.13)$$

where the $n \times n$ matrix B_a

$$B_a \equiv \text{diag} \left(\left. \partial_{\mu_a} W(Y) \right|_{\substack{Y=i\text{-th vacuum} \\ \text{in reference sheet}}} \right), \quad (3.14)$$

is independent of the λ_b , $\partial_{\lambda_b} B_a = 0$.

It is useful to write

$$C_{\mu_a} = D_{x_a} + \Omega_{ab} D_{w_b} \equiv D_{\bar{\lambda}_a}. \quad (3.15)$$

Setting

$$D_{1,A} = (D_{\mu_a}, -D_{\lambda_a}), \quad D_{2,A} = (D_{\bar{\lambda}_a}, D_{\bar{\mu}_a}), \quad \begin{array}{l} a = 1, \dots, g, \\ A = 1, \dots, 2g, \end{array} \quad (3.16)$$

the full set of tt^* equations may be packed into the single equation

$$[D_{\alpha,A}, D_{\beta,B}] = \epsilon_{\alpha\beta} F_{AB} \quad \text{where } F_{AB} = F_{BA}, \quad (3.17)$$

which are the equations of a *hyperholomorphic connection* on a hyperKähler manifold (here $\mathbb{R}^{2g} \times T^{2g}$) also called hyperKähler (or quaternionic) instanton [16–19]. Indeed, eqn.(3.17) is equivalent to the statement that the curvature of the tt^* connection D is of type $(1, 1)$ in all the complex structures of the hyperKähler manifold. For $g = 1$ these hyperholomorphic connections reduce to usual (anti)instantons in $\mathbb{R}^2 \times T^2$, that is, to doubly-periodic instantons in \mathbb{R}^4 .

This may be seen more directly as follows. In complex structure $\zeta \in \mathbb{C}P^1$, the holomorphic coordinates on $\mathbb{R}^{2g} \times T^{2g}$ are

$$u_a^{(\zeta)} = \mu_a - \bar{\lambda}_a/\zeta, \quad \text{and} \quad v_a^{(\zeta)} = \lambda_a + \bar{\mu}_a/\zeta. \quad (3.18)$$

The flat tt^* Lax connection with spectral parameter ζ

$$\begin{aligned} \nabla_{\mu_a}^{(\zeta)} &= D_{\mu_a} + \zeta C_{\mu_a} \equiv D_{\mu_a} + \zeta D_{\bar{\lambda}_a} \\ \nabla_{\bar{\mu}_a}^{(\zeta)} &= D_{\bar{\mu}_a} + \frac{\bar{C}_{\mu_a}}{\zeta} \equiv D_{\bar{\mu}_a} - \frac{D_{\lambda_a}}{\zeta}, \end{aligned} \quad (3.19)$$

annihilates, in this complex structure, all holomorphic coordinates $(u_a^{(\zeta)}, v_a^{(\zeta)})$ and hence is the $(0, 1)$ part, in complex structure ζ , of a connection \mathcal{A} on $\mathbb{R}^{2g} \times T^{2g}$. The statement that the tt^* Lax connection is flat for all ζ is then equivalent to the fact that the $(0, 2)$ part of the curvature of \mathcal{A} vanishes in all complex structures ζ .

The most general tt^* geometry, depending on N_s of standard parameters, N_m twisted mass parameters and N_d doubly-periodic twisted mass parameters is obtained considering such a hyperholomorphic connections which do not depend on some of the angular variables: we drop $2N_s + N_m$ angular variables and obtain a higher dimensional generalization of Hitchin, monopole and instanton equations. However, the tt^* geometry has an additional requirement besides the condition that the connection is hyperholomorphic, namely the eq.(2.2) capturing the *reality structure* [1].

tt^* geometries on $\mathbb{R}^g \times T^{2g}$. As we shall discuss in section 5, the typical tt^* geometry of a 3d model is a variant of the periodic one discussed above in which the complex twisted mass parameters have the form

$$2\mu_a = z_a + iy_a, \quad (3.20)$$

where the z_a 's are real twisted mass parameters and the y_a angular variables which appear on the same physical footing as the vacuum angles x_a . In fact, the \mathbf{S} operation

$$\mathbf{S}: \quad x_a \rightarrow y_a, \quad y_a \rightarrow -x_a, \quad (3.21)$$

should be a symmetry of the physics. To write more symmetric equations, we add g real variables w_a , which do not enter in the Berry connection, in order to complete the space $\mathbb{R}^g \times T^{2g}$ to the flat hyperKähler space $\mathbb{R}^{2g} \times T^{2g}$ on which the tt^* connection is hyperholomorphic (and invariant by translation in the g directions w_a). We then reduce to a special case of the geometry described in eqns.(3.15)–(3.19) with holomorphic coordinates in $\zeta = \infty$ complex structure

$$u_a^{(\infty)} \equiv \mu_a = z_a + i y_a, \quad v_a^{(\infty)} \equiv \lambda_a = x_a + i w_a, \quad (3.22)$$

(the parametrization being chosen to agree with our conventions for 3d models)

The fact that \mathbf{S} is a symmetry of the physics means that it maps the tt^* geometry into itself; in view of the discussion in eqns.(3.15)–(3.19), this means that the effect of \mathbf{S} is to map the complex structure ζ into a complex structure $\tilde{\zeta}(\zeta)$.

To find the map $\zeta \mapsto \tilde{\zeta}$, we start with the \mathbf{S} -transformed complex coordinates

$$\tilde{\mu}_a \equiv \mathbf{S}(\mu_a) = z_a - i x_a, \quad \tilde{\lambda}_a \equiv \mathbf{S}(\lambda_a) = y_a + i w_a, \quad (3.23)$$

and define the \mathbf{S} -dual holomorphic coordinates in (dual) complex structure $\tilde{\zeta}$ as in eqn.(3.18),

$$\tilde{u}_a^{(\tilde{\zeta})} = \tilde{\mu}_a - \bar{\tilde{\lambda}}_a / \tilde{\zeta}, \quad \tilde{v}_a^{(\tilde{\zeta})} = \tilde{\lambda}_a + \bar{\tilde{\mu}}_a / \tilde{\zeta}. \quad (3.24)$$

The map $\zeta \mapsto \tilde{\zeta}(\zeta)$ is then defined by the condition that there exists two holomorphic functions, f and g , such that

$$\tilde{u}_a^{(\tilde{\zeta})} = f(u_a^{(\zeta)}, v_a^{(\zeta)}), \quad \tilde{v}_a^{(\tilde{\zeta})} = g(u_a^{(\zeta)}, v_a^{(\zeta)}). \quad (3.25)$$

f, g are necessarily linear; writing $\tilde{u}_a^{(\tilde{\zeta})} = \alpha_a u_a^{(\zeta)} + \beta_a v_a^{(\zeta)}$ and equating the coefficients of x_a, y_a, w_a, z_a , one finds

$$\tilde{\zeta} = \mathbf{C}(\zeta) \equiv \frac{1 + i\zeta}{\zeta + i}, \quad (3.26)$$

which is the Cayley transform mapping the upper half-plane into the unit disk. In particular, $\zeta = 1$ is a fixed point under this transformation, which is a rotation of $\pi/2$ of the twistor sphere around $\zeta = 1$.

From the discussion around eqn.(3.19), we see that a flat section, $\Pi^{(\zeta)}$, of the tt^* Lax connection at spectral parameter ζ , $\nabla^{(\zeta)}$, is a holomorphic section in complex structure ζ ; then, from the \mathbf{S} -dual point of view $\Pi^{(\zeta)}$ is holomorphic in the $\tilde{\zeta}$ complex structure, that is, a flat section of $\mathbf{S}\nabla^{(\tilde{\zeta})}$. In particular, if $\Pi^{(\zeta)}(x_a, y_a, z_a)$ is a flat section of $\nabla^{(\zeta)}$, then

$$\mathbf{S}\Pi^{(\zeta)}(x_a, y_a, z_a) \equiv \Pi^{(\zeta)}(y_a, -x_a, z_a), \quad (3.27)$$

is a flat section of $\nabla^{(\mathbf{C}^{-1}(\zeta))}$.

General “non-flat” tt^* geometries. As observed in [21], even for the case of surface defects in 4d gauge theories, the tt^* equations reduce to the equations of a hyperholomorphic connection on a hyperKähler manifold, which is the Coulomb branch of the four-dimensional gauge theory compactified on a circle. In that case, though, the hyperKähler manifold has a non-flat metric, and the tt^* data has a more intricate dependence on the angular coordinates. A typical example of the tt^* geometries which arise in this non-flat setup is associated to the moduli space M of solutions of a Hitchin system on some Riemann surface C : the universal bundle on $M \times C$ supports a hyperholomorphic connection in the M directions and a Hitchin system on the C directions, and the two are compatible exactly as above: the (anti)holomorphic connection on M in complex structure ζ commutes with the Lax connection of the Hitchin system with spectral parameter ζ .

3.1 A basic example of 2d periodic tt^* geometry

The simplest and most basic example of periodic tt^* geometry corresponds to the Landau–Ginzburg model

$$W(Y) = \mu Y - e^Y, \quad (3.28)$$

which may be seen as the mirror of a 2d chiral field [12] with a twisted complex mass

$$m_{\text{twisted}} = 4\pi i \mu. \quad (3.29)$$

The exact tt^* metric for this model is computed in Appendix A of [20]. This tt^* geometry is also a very simple case of the general 2d-4d structures analyzed in [21].

We give a quick review of the tt^* metric for this theory (with some extra detail) and then we shall compute the associated amplitudes $\Pi_i^a = \langle D_a | i \rangle$.

3.1.1 tt^* metric

Taking the periodicity into account, this theory has a single vacuum at $Y = \log \mu$, as expected for a massive 2d chiral field. The tt^* equations thus reduce to $U(1)$ monopole equations on $\mathbb{R}^2 \times S^1$, which can be solved in terms of a harmonic function. We expect the solution to be essentially independent on the phase of the mass, and the only singularities should occur when both the mass and the flavor Wilson lines are zero, so that the 2d chiral field has a zero-mode on the circle. Indeed, we will see momentarily that the correct solution to the tt^* equations corresponds to a single Dirac monopole of charge 1 placed at $\mu = \bar{\mu} = x = 0$.¹²

¹²The enthusiastic reader can check this result directly from the definition of the tt^* data, by decomposing the 2d chiral field into KK modes on the circle and computing the contribution to the Berry’s connection from each of these modes. The action for each KK mode is not periodic in x , and n -th KK mode gives a single Dirac monopole at $x = 2\pi n$. Together they assemble the desired Dirac monopole solution on $\mathbb{R}^2 \times S^1$.

It is interesting to describe in detail the relation between the monopole solution and the standard tt^* data. In an unitary gauge, we would write

$$\begin{aligned}
C_\mu &= \partial_x - iA_x + V \\
-\bar{C}_{\bar{\mu}} &= \partial_x - iA_x - V \\
D_\mu &= \partial_\mu - iA_\mu \\
D_{\bar{\mu}} &= \partial_{\bar{\mu}} - iA_{\bar{\mu}}
\end{aligned} \tag{3.30}$$

with V being the Harmonic function, A the associated monopole connection. Without loss of generality, we can split V into an x -independent part and x -dependent part as

$$V(\mu, \bar{\mu}, x) = \frac{1}{2}v(\mu) + \frac{1}{2}\bar{v}(\bar{\mu}) + \frac{1}{2}\partial_x L(\mu, \bar{\mu}, x) \tag{3.31}$$

for a periodic harmonic function $L(\mu, \bar{\mu}, x)$, and solve for the connection

$$\begin{aligned}
iA_\mu &= -\frac{1}{2}\partial_\mu a(\mu) + \frac{1}{2}\partial_\mu L \\
iA_{\bar{\mu}} &= +\frac{1}{2}\partial_{\bar{\mu}} \bar{a}(\bar{\mu}) - \frac{1}{2}\partial_{\bar{\mu}} L \\
iA_x &= -\frac{1}{2}v(\mu) + \frac{1}{2}\bar{v}(\bar{\mu})
\end{aligned} \tag{3.32}$$

Thus

$$\begin{aligned}
C_\mu &= \partial_x + v + \frac{1}{2}\partial_x L \\
-\bar{C}_{\bar{\mu}} &= \partial_x - \bar{v} - \frac{1}{2}\partial_x L \\
D_\mu &= \partial_\mu + \frac{1}{2}\partial_\mu a - \frac{1}{2}\partial_\mu L \\
D_{\bar{\mu}} &= \partial_{\bar{\mu}} - \frac{1}{2}\partial_{\bar{\mu}} \bar{a} + \frac{1}{2}\partial_{\bar{\mu}} L
\end{aligned} \tag{3.33}$$

We can then go to the ‘‘topological basis’’ by the complexified gauge transformation with parameter $\frac{1}{2}L(\mu, \bar{\mu}, x) - \frac{1}{2}a(\mu) - \frac{1}{2}\bar{a}(\bar{\mu})$:

$$\begin{aligned}
C_\mu &= \partial_x + v \\
-\bar{C}_{\bar{\mu}} &= \partial_x - \bar{v} - \partial_x L \\
D_\mu &= \partial_\mu + \partial_\mu a - \partial_\mu L \\
D_{\bar{\mu}} &= \partial_{\bar{\mu}}
\end{aligned} \tag{3.34}$$

The gauge transformation parameter is directly related to the tt^* metric [1], which reduces in this case to a real positive function of x and $|\mu|$, $G(x, |\mu|)$ of period 1 in x :

$$G(x, |\mu|) = e^{L(\mu, \bar{\mu}, x) - a(\mu) - \bar{a}(\bar{\mu})}. \tag{3.35}$$

Using¹³ the relation $\eta = \mu^{-1}$ the reality condition $|\mu|^2 G(-x, |\mu|) G(x, |\mu|) = 1$ tells us that L is odd in x . Also, we find $a(\mu) = \frac{1}{2} \log \mu$ and $\log G = \log L - \frac{1}{2} \log |\mu|$.

As L is harmonic,

$$\frac{1}{|\mu|} \frac{\partial}{\partial |\mu|} \left(|\mu| \frac{\partial}{\partial |\mu|} L \right) + 4 \frac{\partial}{\partial x} \left(\frac{\partial}{\partial x} L \right) = 0, \quad (3.36)$$

periodic and odd, it has an expansion in terms of Bessel–MacDonald functions of the form

$$L(x, |\mu|) = \sum_{m=1}^{\infty} a_m \sin(2\pi m x) K_0(4\pi m |\mu|), \quad (3.37)$$

for certain coefficients a_m which are determined by the boundary conditions. We may use either the UV or IR boundary conditions, getting the same a_m [20]. For instance, in the UV we must have the asymptotics as $|\mu| \rightarrow 0$

$$L(x, |\mu|) = -2(q(x) - 1/2) \log |\mu| + \Lambda(x) + O(|\mu|), \quad (3.38)$$

where $q(x)$ is the SCFT $U(1)$ charge of the chiral primary e^{xY} ($0 \leq x < 1$) at the UV fixed point, while the function $\Lambda(x)$ encodes the OPE coefficients at that fixed point [1, 7]. From the chiral ring relations we have $q(x) = x$. From the expansion

$$K_0(z) = -\log(z/2) - \gamma + O(z^2 \log z) \quad \text{as } z \sim 0. \quad (3.39)$$

we get

$$(1 - 2x) \log |\mu| + \Lambda(x) = - \sum_m a_m \sin(2\pi m x) \left(\log |\mu| + \log m + \log 2\pi + \gamma \right). \quad (3.40)$$

Comparing the coefficients of $\log |\mu|$, we see that the a_m 's are just the Fourier coefficients of the first (periodic) Bernoulli polynomial, and hence

$$a_m = -\frac{2}{\pi} \frac{1}{m}. \quad (3.41)$$

Then (for $0 < x < 1$)

$$\begin{aligned} \Lambda(x) &= (1 - 2x) (\log 2\pi + \gamma) + \frac{2}{\pi} \sum_{m \geq 1} \sin(2\pi m x) \frac{\log m}{m} = \\ &= 2 \log \Gamma(x) + \log \sin(\pi x) - \log \pi, \end{aligned} \quad (3.42)$$

where the equality in the second line follows from Kummer's formula for the Fourier coefficients of the Gamma–function[22]. In particular, the UV OPE coefficients have the expected form [1, 7].

¹³In a vacuum basis, the pairing η is diagonal, proportional to the inverse determinant of the Hessian of the superpotential, see [8].

As we have $v(\mu) = \log \mu$, we can recognize the periodic monopole solution

$$\begin{aligned} V(\mu, \bar{\mu}, x) &= \log |\mu| - 2 \sum_{m=1}^{\infty} \cos(2\pi m x) K_0(4\pi m |\mu|) = \\ &= -\frac{1}{2} \sum_{n \in \mathbb{Z}} \left(\frac{1}{\sqrt{|2\mu|^2 + (x-n)^2}} - \kappa_n \right) - \gamma \end{aligned} \quad (3.43)$$

where κ_n is some constant regulator (see eqn.(B.5)).

It is convenient to give a representation of the solution $L(x, |\mu|)$ in terms of a convergent integral representation. From the equality (for $\text{Re } z > 0$)

$$K_0(z) = \frac{1}{2} \int_0^{\infty} \frac{dt}{t} e^{-\frac{1}{2} z(t+t^{-1})}, \quad (3.44)$$

we see that for $\text{Re } \mu > 0$

$$\begin{aligned} L(x, \mu, \bar{\mu}) &= -\frac{1}{\pi} \sum_{m=1}^{\infty} \frac{\sin(2\pi m x)}{m} \int_0^{\infty} \frac{dt}{t} e^{-2\pi m(\mu t + \bar{\mu} t^{-1})} = \\ &= \frac{1}{2\pi i} \int_0^{\infty} \frac{dt}{t} \log \left(\frac{1 - e^{-2\pi(\mu t + \bar{\mu} t^{-1} - ix)}}{1 - e^{-2\pi(\mu t + \bar{\mu} t^{-1} + ix)}} \right). \end{aligned} \quad (3.45)$$

For $\text{Re } \mu > 0$ the integral is absolutely convergent. If $\text{Re } \mu \not> 0$ (and $\mu \neq 0$), just replace $\mu \rightarrow e^{i\alpha} \mu$ in such a way that $\text{Re}(e^{i\alpha} \mu) > 0$ (or, equivalently, rotate the integration contour). Notice that the expression (3.45) makes sense even for μ and $\bar{\mu}$ independent complex variables (as long as $\text{Re } \mu > 0$ and $\text{Re } \bar{\mu} > 0$).

2d tt^* computes a second interesting physical quantities besides the metric, namely the CFIV ‘new index’ $Q(x, |\mu|)$ [23]. Several explicit expression for the CFIV index of this model may be found in appendix A.3.

3.1.2 The amplitude $\langle D_a | \phi(x) \rangle = \langle D_a | 0 \rangle_x$

The equations for a flat section Π of the tt^* Lax connection look somewhat forbidding

$$\begin{aligned} (\partial_\mu + \zeta \partial_x) \log \Pi &= \partial_\mu L - \zeta v - \partial_\mu a \\ (-\zeta \partial_{\bar{\mu}} + \partial_x) \log \Pi &= \bar{v} + \partial_x L \end{aligned} \quad (3.46)$$

Observe that Π is defined up to multiplication by an arbitrary function of $\zeta \mu - x - \zeta^{-1} \bar{\mu}$. This is related to the fact that any D-brane has infinitely many images, produced by shifts in the flavor grading of the Chan-Paton bundle. Starting from a single D-brane amplitude Π_0 one can produce a countable basis

$$\Pi_k = e^{2\pi i k (\zeta \mu - x - \zeta^{-1} \bar{\mu})} \Pi_0 \quad k \in \mathbb{Z}. \quad (3.47)$$

for the infinite-dimensional vector space of flat sections of the tt^* Lax connection

Writing

$$\log \Pi = \Phi - \frac{1}{2} \log \mu - \zeta \mu (\log \mu - 1) - \zeta^{-1} \bar{\mu} (\log \bar{\mu} - 1) + \text{const.}, \quad (3.48)$$

(we will fix the additive constant later by choosing a convenient overall normalization of Π) we isolate the interesting part

$$\begin{aligned} (\partial_\mu + \zeta \partial_x) \Phi &= \partial_\mu L \\ (-\zeta \partial_{\bar{\mu}} + \partial_x) \Phi &= \partial_x L \end{aligned} \quad (3.49)$$

In view of the expression

$$L = -\frac{1}{2\pi i} \sum_{m \neq 0} e^{2\pi i m x} \int_0^\infty \frac{1}{m t} e^{-2\pi |m|(\mu t + \bar{\mu} t^{-1})} dt, \quad (3.50)$$

for $\text{Re } \mu > 0$ we look for a solution Φ of the form

$$\Phi(x, \mu, \bar{\mu}) = \sum_{m \neq 0} e^{2\pi i m x} \int_0^\infty f_m(t) e^{-2\pi |m|(\mu t + \bar{\mu} t^{-1})} dt, \quad (3.51)$$

for some functions $f_m(t)$ to be determined. Plugging this ansatz in the equations we get

$$f_m(t) = \frac{i}{2\pi m} \frac{1}{t - i \zeta \text{sign}(m)}. \quad (3.52)$$

Then

$$\Phi = \frac{1}{2\pi i} \int_0^\infty \frac{dt}{t - i\zeta} \log\left(1 - e^{-2\pi(\mu t + \bar{\mu} t^{-1} - ix)}\right) - \frac{1}{2\pi i} \int_0^\infty \frac{dt}{t + i\zeta} \log\left(1 - e^{-2\pi(\mu t + \bar{\mu} t^{-1} + ix)}\right). \quad (3.53)$$

For $\text{Re } \mu, \text{Re } \bar{\mu} > 0$ the integrals are absolutely convergent and define an analytic function of μ and $\bar{\mu}$ (seen as independent complex variables).

This expression has an important discontinuity along the imaginary ζ axis, where the poles cross the integration contours, and is analogous to the integral equations which gives the thimble brane amplitudes in the standard tt^* case [7]. It is also a simple version of the integral equations which describe general 2d-4d systems in [21]. The discontinuity along the positive and negative imaginary axes are

$$\pm \log\left(1 - e^{\pm 2\pi i(\zeta \mu - x - \zeta^{-1} \bar{\mu})}\right). \quad (3.54)$$

The two functions Π_\pm defined by the analytic continuation from the positive and negative half-planes must correspond to the amplitudes for the thimble branes for the model. We will identify these branes momentarily.

The same discontinuities appear at fixed ζ as we vary the phase of μ , as one has to rotate the integration contours while moving μ out of the $\text{Re } \mu > 0$ half-plane. Notice

that the composition of the two discontinuities in Φ we encounter while rotating the phase of μ by 2π , i.e. $\pi i + 2\pi i(\zeta\mu - x - \zeta^{-1}\bar{\mu})$, cancel against the extra terms in the definition 3.48 of Π , leaving only

$$\Pi(e^{2\pi i}\mu, e^{-2\pi i}\bar{\mu}, x) = e^{2\pi i x}\Pi(\mu, \bar{\mu}, x)$$

which is the gauge transformation which leaves the tt^* data invariant. This equation is equivalent to the statement $q(x) = x$. Thus all the pieces conspire to make the sections Π_{\pm} single-valued as functions of μ (but not of ζ !).

The function Φ is also periodic in x , and enjoys a number of interesting properties. First of all, it satisfies the functional equation (for $\text{Re } \zeta\mu, \text{Re } \zeta^{-1}\bar{\mu} > 0$)

$$\Phi(-x, \zeta^{-1}\bar{\mu}, \zeta\mu) - \Phi(x, \zeta\mu, \zeta^{-1}\bar{\mu}) = L(x, \mu, \bar{\mu}) \quad (3.55)$$

which just says that the tt^* metric can be computed out of the amplitude $\Pi(x)$ in the usual way. Second, for all integers $n \in \mathbb{N}$ it satisfies a ‘Gauss multiplication formula’ of the same form as the one satisfied by $\log \Gamma(z)$

$$\Phi(0, n\zeta\mu, n\zeta^{-1}\bar{\mu}) = \sum_{k=0}^{n-1} \Phi(k/n, \zeta\mu, \zeta^{-1}\bar{\mu}). \quad (3.56)$$

Eqns.(3.55)(3.56) are shown in appendix A.1.

3.1.3 The limit $\bar{\mu} \rightarrow 0$ and brane identification

Seeing the amplitude $\Pi(x, \mu, \bar{\mu})$ as a function of independent complex variables μ and $\bar{\mu}$, it make sense to consider its form in the limit $\bar{\mu} \rightarrow 0$. As discussed in section 2, this is the limit where we expect $\Pi(x, \mu, 0)$ to simplify, and satisfy a simple differential equation. We will check to see how this emerges in this section (eqn.(2.10)).

The asymmetric limit $\bar{\mu} \rightarrow 0$ is also important to identify which kind of brane amplitude corresponds to each solution to the Lax equations, and in particular to identify the unique solution which corresponds to a (correctly normalized) Dirichlet brane amplitude, $\langle D|x \rangle_{\zeta}$, and its relations with the Leftshetz thimble amplitudes. We saw that the difference between the log of any two solutions, Π_1, Π_2 , is a holomorphic function of $\zeta\mu - x - \bar{\mu}/\zeta$

$$\log \Pi_1 - \log \Pi_2 = f(\zeta\mu - x - \bar{\mu}/\zeta). \quad (3.57)$$

In particular, two solutions which are equal at $\bar{\mu} = 0$, are equal everywhere. Therefore the identity of the corresponding boundary conditions is uniquely determined by comparing their $\bar{\mu} \rightarrow 0$ limit [11], with the period integrals of $\exp(-\zeta\beta W)$. This limit can be alternatively computed (assuming the correctness of our conjecture of the equivalence of this limit with supersymmetric partition functions [52, 53]) with a direct localization computation for the partition function of the 2d chiral on a hemisphere [54].

We are looking at

$$\begin{aligned} \log \Pi = & -\frac{1}{2} \log \mu - \zeta \mu (\log \mu - 1) + \text{const.} \\ & + \frac{1}{2\pi i} \int_0^\infty \frac{dt}{t - i\zeta} \log\left(1 - e^{-2\pi(\mu t - ix)}\right) - \frac{1}{2\pi i} \int_0^\infty \frac{dt}{t + i\zeta} \log\left(1 - e^{-2\pi(\mu t + ix)}\right). \end{aligned} \quad (3.58)$$

We claim that choosing the additive constant to be 0, the branch Π_- of Π in the negative ζ half plane becomes

$$\Pi_- = \frac{1}{\sqrt{2\pi}} \Gamma(-\zeta\mu + \{x\}) \mu^{-\{x\}} (-\zeta)^{\frac{1}{2} + \zeta\mu - \{x\}} \quad (3.59)$$

and the branch Π_+ of Π in the negative ζ half plane becomes

$$\Pi_+ = \frac{\sqrt{2\pi}}{\Gamma(\zeta\mu + 1 - \{x\})} \mu^{-\{x\}} \zeta^{\frac{1}{2} + \zeta\mu - \{x\}} \quad (3.60)$$

where $\{x\} \equiv x - [x]$ is the fractional part, $0 \leq \{x\} < 1$. Note that these expressions are consistent with (3.56) in view of the Gauss multiplication formula for $\Gamma(z)$ [22].

A straightforward way to prove these identities is to observe that the right hand sides have the correct asymptotic behaviour at large ζ , the correct discontinuities, and no zeroes or poles in the region where we want to equate them to the integral formula. Thus they must coincide with the result of the integral formula. By setting $x = 0$ or $x = 1/2$ in these identities we get well-known integral representations of $\log \Gamma(\mu)$ or, respectively, $\log \Gamma(\mu + 1/2) - \frac{1}{2} \log \mu$ (see appendix A.2.1). Setting $\mu = 0$ in our identity produces a new proof of the Kummer formula (appendix A.2.2).

Comparing with a direct localization computation for the partition function of the 2d chiral on a hemisphere [54], we see that, for all values of ζ , the behavior (3.59) corresponds to a brane with Neumann boundary conditions and (3.60) to Dirichlet b.c. We conclude that the thimble brane of the LG mirror corresponds to either Neumann or Dirichlet boundary conditions for the 2d chiral field. The match with the localization computations is surprisingly detailed, especially if we turn off x and identify $-\zeta\beta$ with $r\Lambda_0$ in [54].

Finally, we can compare the result to the expected integral expressions for the asymmetric conformal limits

$$\int_D e^{xY - \zeta\mu Y + \zeta e^Y} dY$$

For example, for ζ in the negative half-plane we can do the integral on the positive real Y axis setting $t = -\zeta e^Y$, i.e.

$$(-\zeta)^{-x + \zeta\mu} \int_0^\infty t^{x - \zeta\mu - 1} e^{-t} dt = (-\zeta)^{-x + \zeta\mu} \Gamma(x - \zeta\mu)$$

which is as expected.

3.2 A richer example

After discussing a model which gives rise to a single periodic $U(1)$ Dirac monopole as a tt^* geometry, it is naturally to seek a model associated to a single smooth $SU(2)$ monopole solution. It is not hard to guess the correct effective LG model:

$$W(Y) = \mu Y - e^{\frac{t}{2}+Y} + e^{\frac{t}{2}-Y}. \quad (3.61)$$

We recognize this as the mirror of a $\mathbb{C}P^1$ sigma model [12] with FI parameter t and twisted mass $4\pi i\mu$ for its $SU(2)$ flavor symmetry. We will come back to the standard tt^* geometry in the t cylinder momentarily. Unlike the previous example, it is not possible to solve this model explicitly. Nevertheless we can predict properties of the solution, based on the previous example, as well as general physical reasoning.

The model has two vacua, with opposite values of W , and will give rise to a rank 2 bundle, with $SU(2)$ structure group. At large $|\mu|$ we get either of the vacua $Y \sim \pm(-\frac{t}{2} + \log \mu)$, and the two vacua are well-separated. The solution approaches an Abelian monopole of charge ± 1 . On the other hand, $Y(\mu)$ does not have logarithmic singularities anywhere: there are never massless particles in the spectrum, and thus no Dirac singularities in the interior. This confirms that the tt^* geometry for the μ parameter will be a smooth $SU(2)$ monopole. The parameter t controls the constant part of the Higgs field and Wilson line at large μ .

On the other hand, the tt^* geometry for the t parameter is well-known: the boundary conditions of the Hitchin system's Higgs field C_t are controlled by

$$\frac{1}{2}\text{Tr } C_t^2 = (\partial_t W)^2 = \frac{\mu^2}{4} - e^t \quad (3.62)$$

Thus we have a standard regular singularity at the $t \rightarrow -\infty$ end of the cylinder, with residues $\pm\frac{\mu}{2}$ in the Higgs field and $\pm x$ in the connection. We have the mildest irregular singularity at the $t \rightarrow \infty$ end of the cylinder.

The tt^* machinery predicts that the Lax connections for the BPS monopole connection associated to the μ direction and for the Hitchin system in the x direction will commute (for the same values of the spectral parameter). This fact may appear striking. It is useful to think about it in terms of an isomonodromic problem. For example, the Hitchin system has a unique solution for given μ, x . Furthermore, up to conjugation, the monodromy data of the Lax connection with spectral parameter ζ only depends on the combination $\mu\zeta - x - \bar{\mu}\zeta^{-1}$ and it is annihilated by the combinations of derivatives $\partial_\mu + \zeta\partial_x$ and $\partial_{\bar{\mu}} - \zeta^{-1}\partial_x$. These facts are what make it possible to find connections $D_\mu + \zeta D_x$ and $D_{\bar{\mu}} - \zeta^{-1}\bar{D}_x$ which commute with the Hitchin Lax connections, and which become the Lax connection for the BPS monopole equation.

The LG model has several interesting A-branes, which are mirror to the basic B-branes of the $\mathbb{C}P^1$ sigma model [11]: we can have either a Dirichlet brane at the

north or south pole, or a Neumann brane with $n + \frac{1}{2}$ units of world volume flux. The corresponding amplitudes were identified in [21] with specific flat sections of the Hitchin system Lax connection. The Dirichlet branes correspond to the monodromy eigenvectors at the regular singularity. The basic Neumann brane is the unique section which decreases exponentially approaching the irregular singularity. The whole tower of Neumann branes is obtained by transporting the basic one n times around the cylinder. As the full BPS spectrum of the $\mathbb{C}P^1$ model is known, the actual brane amplitudes can be computed from the integral equations derived in [7, 26], corrected by the presence of twisted masses as in [21].

3.3 Some doubly-periodic examples

As we seek examples of well-defined doubly-periodic systems, it is natural to start from a simple, smooth doubly-periodic instanton solution [79] and work backwards to identify an effective LG model associated to it. The simplest choice would be a doubly-periodic $SU(2)$ instanton of minimal charge. The identification of the LG model is rather straightforward using the connection to the Nahm transform detailed in the next section. Here we can anticipate the answer:

$$W = m_b \log \Theta\left(X + \frac{z}{2}, \tau\right) - m_b \log \Theta\left(X - \frac{z}{2}, \tau\right) - aX \quad (3.63)$$

Here X is the doubly-periodic LG field, a the deformation parameter whose tt^* geometry will reproduce the doubly-periodic instanton, Θ is the usual theta function and m_b, z two extra parameters.

The superpotential has discontinuities of the form $(n_1 + \tau n_2)a + (n_3 + zn_2)m_b$. We will focus on the tt^* geometry in a first, and then extend it to a, m_b . The instanton is defined over the space parameterized by a and the two angles θ_1 and θ_2 dual to the charges n_1 and n_2 . The vacua are determined by

$$a = m_b \frac{\Theta'(X + \frac{z}{2})}{\Theta(X + \frac{z}{2})} - m_b \frac{\Theta'(X - \frac{z}{2})}{\Theta(X - \frac{z}{2})} \quad (3.64)$$

and C_a is controlled by the critical value of X . At large a ,

$$X \sim \pm \left(\frac{z}{2} + \frac{m_b}{a} + \dots \right), \quad (3.65)$$

and thus z controls the large a asymptotic value of the $SU(2)$ instanton connection on the (θ_1, θ_2) torus direction and m_b the first subleading coefficient.

Because of the appearance of m_b in the n_2 monodromy, the C_{m_b} differential operator must include both the usual ∂_{x_3} expected for a standard mass parameter, and an extra $z\partial_{x_2}$ which mixes it with the doubly-periodic instanton directions. Thus rather than a direct product of doubly-periodic instanton equations and periodic monopole equations, we get a slightly more general reduction of an eight-dimensional

hyper-holomorphic connection down to a system over $\mathbb{R}^4 \times T^3$, where T^3 has a metric determined by τ and z .

We can easily describe a system which behaves a bit better:

$$\begin{aligned} W &= m_b \log \Theta(X + z, \tau) + m_b \log \Theta(X - z, \tau) - 2m_b \log \Theta(X, \tau) - aX = \\ &= m_b \log (\wp(X) - \wp(z)) - aX \end{aligned} \quad (3.66)$$

This superpotential has only the standard $(n_1 + \tau n_2)a + n_3 m_b$ discontinuities, and thus we get three separate and compatible connections: an $SU(3)$ doubly-periodic instanton from the a deformation, a rank 3 periodic monopole from the m_b deformation and a rank 3 Hitchin system from the z deformation.

The asymptotic form of C_a for large $|a|$ in the three vacua is $X \sim z + m_b/a$, $X \sim -z + m_b/a$, $X \sim -2m_b/a$. The tt^* geometry for a should be smooth in the interior.

In order to understand the other deformations, it is useful to massage a bit the chiral ring relation which follows from the superpotential. We have

$$m_b \wp'(X) = a\wp(X) - a\wp(z) \quad (3.67)$$

Using the standard cubic relation for the Weierstrass function, we get

$$4\wp(X)^3 - g_2\wp(X) - g_3 = \frac{a^2}{m_b^2} (\wp(X) - \wp(z))^2 \quad (3.68)$$

As the C_{m_b} eigenvalues are the values of $\log(\wp(X) - \wp(z))$, the above form of the chiral ring relation gives the holomorphic data of the periodic monopole solution. It appears to have logarithmic singularity, corresponding to a Dirac monopole singularity at $m_b = 0$ of charges 1, 1, -2 and no logarithmic growth at infinity: there must be a smooth monopole configuration screening the Dirac singularity.

The model has an interesting limit $z \rightarrow 0$, with constant $m_b z^2$:

$$W = c\wp(X) - aX \quad (3.69)$$

This is the basic building block for models considered in [27], such as

$$W = \lambda \left(\sum_{a=1}^{N-1} (\wp(Y_a) - m_a Y_a) + \wp\left(-\sum_{a=1}^N Y_a\right) \right). \quad (3.70)$$

3.4 Non-commutative tt^* geometries

It is natural to wonder what would happen if we took a simpler version of the doubly-periodic examples, a superpotential involving a single θ function:

$$W = \log \Theta(X, \tau) - \mu(X + \tau/2 + 1/2) \quad (3.71)$$

This superpotential and the chiral ring relation

$$\mu = \frac{\Theta'(X, \tau)}{\Theta(X, \tau)} \quad (3.72)$$

only make sense if the parameter μ is taken to have a periodic imaginary part.

This makes sense if X is actually part of a 2d gauge multiplet and μ is the corresponding FI parameter. Indeed, in 2d the field strength of an $U(1)$ vector supermultiplet is a twisted chiral field Σ with the real part of the F -term equal to the field strength 2-form. Hence the F -terms roughly take the form

$$i \int F^a \operatorname{Im} \partial_{\Sigma_a} W + \int d^2z D^a \operatorname{Re} \partial_{\Sigma_a} W, \quad (3.73)$$

and the $\operatorname{Im} \partial_{\Sigma_a} W$ are field-dependent θ -angles which need to be well-defined only up to shifts by integers. Indeed, the flux $\int F$ is quantized in multiples of 2π , and the action is still well-defined mod $2\pi i$. Thus we may allow a (twisted) superpotential $W(\Sigma_a)$ such that $\partial_{\Sigma_a} W$ is defined up to integral multiples of $2\pi i$.

Naively, one may thus expect the tt^* geometry to be an instanton solution in $\mathbb{R} \times T^3$. The situation, though, is more complex than that. The images of a vacuum under the two translations of X by 1 or τ are associated to different values for μ , as translations of X by τ require a shift of μ by $2\pi i$. Thus if we try to form Bloch wave vacua with angles $\theta_{1,2}$ as before, we cannot treat μ and θ_2 as commuting variables. Rather, we need some Heisenberg commutation relation such that $e^{in\theta_2}$ acts on μ by a shift of $2\pi in$.

The natural guess is that, in situations such as this, the tt^* equations may define a hyperholomorphic connection on a *non-commutative* version of, say, $\mathbb{R} \times T^3$ where at least two torus directions do not commute among themselves. It turns out that such non-commutative tt^* geometries are very common for 4 supercharge models arising from 4d gauge theories, as we shall see later in section 8. In particular, the 4d theory with spectral curve (8.11) may be modelled by a 2d theory with a superpotential W such that

$$\exp(\partial_X W(X)) = \frac{\Theta(X + \mu'/2, \tau)}{\Theta(X - \mu'/2, \tau)}. \quad (3.74)$$

For μ' small this gives

$$W(X) = \mu' \log \Theta(X, \tau) + O(\mu'^2), \quad (3.75)$$

whose tt^* geometry may be meaningful only in the non-commutative framework.

Another situation where a non-commutative tt^* geometry may appear is a 2d-4d system in the presence of Nekrasov deformation in the transverse plane to the defect and/or a supersymmetric Melvin twist in the tt^* compactification. The two are related because the Nekrasov deformation parameter behaves as a 2d twisted

mass for the rotation (plus R-charge rotation) in the plane transverse to the defect, which is used to define the Melvin twist. In such a situation, the electric and magnetic Wilson lines cease to be commutative variables. The corresponding non-commutative version of the tt^* geometry should be related to the motivic Kontsevich-Soibelman wall-crossing formula.

A full discussion of the non-commutative tt^* geometries is outside the scope of the present paper. Here we limit ourselves to a general discussion of how non-commutative structures could possibly emerge from the standard tt^* machinery.

3.4.1 tt^* geometry for the models (3.71)(3.75)

In these examples the chiral field X takes values in a complex torus E of periods $(1, \tau)$, that is, we periodically identify

$$X \sim X + k + \tau m, \quad k, m \in \mathbb{Z}. \quad (3.76)$$

For definiteness, we choose $\Theta \equiv \theta_3$ which vanishes at the point $X_{\text{cr}} = (1 + \tau)/2$. Since the superpotential is not univalued in E , to define the tt^* geometry we must lift the model to a cover where W is well defined; in the process we get infinitely many copies of the single vacuum. However in this case there are more copies of the vacuum than just the lattice translates $X_0 + (k + m\tau)$, $k, m \in \mathbb{Z}$. For instance for the model (3.71), since μ is a periodic variable, the actual equation defining the classical vacua is [25]

$$\exp\left[\partial_X W(X)\right] = 1. \quad (3.77)$$

The LHS is a holomorphic function in $E \setminus (1 + \tau)/2$ with an essential singularity at the point $X_{\text{cr}} = (1 + \tau)/2$. By the Big Picard theorem, the equation (3.77) has *infinitely many* solutions in any open neighborhood of the point $(1 + \tau)/2$. These solutions may be interpreted as cover copies of the vacuum due to the non-trivial monodromy around the point X_{cr} .

The monodromy action. To be systematic, we consider X as a field taking value in the Kähler manifold $K = E \setminus X_{\text{cr}}$ and go to its universal cover \tilde{K} on which W is defined as a univalued function by analytic continuation. Let \mathbf{M} be the monodromy group of the cover $\tilde{K} \rightarrow K$, which is identified with $\pi_1(K)$; we need to know how it is represented on the vacuum bundle $\mathcal{V} \rightarrow K$. Indeed, the monodromy group acts by symmetries just as in the ordinary periodic case. For definiteness we choose $X = 0$ as the base point, and consider the homotopy group of paths based at the origin, $\pi_1(K, 0)$. This group is generated by three loops u_1, u_2, ℓ subject to a single relation

$$\ell = u_2^{-1} u_1^{-1} u_2 u_1, \quad (3.78)$$

where

$$u_1 = t \pmod{\mathbb{Z} + \mathbb{Z}\tau}, \quad u_2 = t\tau \pmod{\mathbb{Z} + \mathbb{Z}\tau}, \quad 0 \leq t \leq 1, \quad (3.79)$$

and ℓ is a loop which starts from the origin, go to the point $(1 + \tau)/2$ along the segment connecting the two points, make a counter-clockwise loop around the point $(1 + \tau)/2$ and then returns back to the origin along the segment.

One consequence of eqn.(3.78) is that — if the monodromy along the loop ℓ , M_ℓ , acts non-trivially on the vacuum bundle \mathcal{V} — the two basic lattice translations $X \rightarrow X + 1$ and $X \rightarrow X + \tau$ *do not* commute. In the simplest periodic models we set the spectrum of the lattice translation operators to be $\exp(2\pi i x_i)$; in the present case, $M_\ell \neq 1$ implies that the two translations cannot be diagonalized simultaneously on the vacua and hence the vacuum angles x_1 and x_τ cannot be simultaneously defined.

As in the standard periodic case, the action of the monodromy on the vacuum bundle is induced by the action of the monodromy on the superpotential W . Hence, let us consider the monodromy action on W . To encompass both models (3.71)(3.75) in a single computation, we consider the superpotential

$$W(X) = \mu' \log \Theta(X, \tau) - \mu X. \quad (3.80)$$

On \tilde{K} we introduce the meromorphic $\mathfrak{sl}(3, \mathbb{C})$ connection (we set $\theta(x) \equiv \theta_3(\pi x)$)

$$A = \begin{pmatrix} 0 & d\left(\mu' \frac{\theta'}{\theta} - \mu\right) & 0 \\ 0 & 0 & dx \\ 0 & 0 & 0 \end{pmatrix}$$

and look for solutions to

$$d\Psi = \Psi A. \quad (3.81)$$

A fundamental solution is

$$\Psi = \begin{pmatrix} 1 & \left(\frac{\mu' \theta'(x)}{\theta(x)} - \mu\right) W \\ 0 & 1 & x \\ 0 & 0 & 1 \end{pmatrix} \quad (3.82)$$

with W is as in eqn.(3.80). The general solution is then given by $M\Psi$ with M a constant matrix. Let $\gamma \in \pi_1(K, 0)$ be a closed loop. The analytic continuation of the solution Ψ along γ , Ψ_γ , is also a solution to the above linear problem, and hence there exists a constant 3×3 matrix M_γ such that

$$\Psi_\gamma = M_\gamma \Psi. \quad (3.83)$$

The matrices M_γ are upper triangular with 1's on the main diagonal. The map $\pi_1(K, 0) \rightarrow SL(3, \mathbb{C})$ given by $\gamma \mapsto M_\gamma$ is the monodromy representation we are interested in. Let us compute the monodromy representation of the generators u_1, u_2, ℓ

$$M_{u_1} = \begin{pmatrix} 1 & 0 & -\mu \\ 0 & 1 & 1 \\ 0 & 0 & 1 \end{pmatrix} \quad M_{u_2} = \begin{pmatrix} 1 & -2\pi i \mu' & -(\mu + i\pi \mu')\tau \\ 0 & 1 & \tau \\ 0 & 0 & 1 \end{pmatrix} \quad M_\ell = \begin{pmatrix} 1 & 0 & -2\pi i \mu' \\ 0 & 1 & 0 \\ 0 & 0 & 1 \end{pmatrix}. \quad (3.84)$$

One checks that these matrices satisfy the group relation (3.78), and hence give a representation of the group $\pi_1(K)$. The matrix M_ℓ is a *central element* of the monodromy group–algebra generated by M_{u_1}, M_{u_2} . Hence we may diagonalize its action on the vacuum bundle introducing the q -vacua

$$M_\ell|q\rangle = q|q\rangle \quad (3.85)$$

(we use the same symbol to denote a monodromy matrix and the operator implementing it on \mathcal{V}). Then in the q sector the cover group–algebra becomes identified with the quantum torus algebra ($M_i \equiv M_{u_i}$)

$$M_2 M_1 = q M_1 M_2. \quad (3.86)$$

The vacuum bundle \mathcal{V} over (the universal cover of) coupling constant space may be decomposed into M_ℓ -eigenbundles

$$\mathcal{V} = \bigoplus_q \mathcal{V}_q. \quad (3.87)$$

Since the tt^* geometry is described by equations written in terms of commutators, and M_ℓ is central and a symmetry, the tt^* equations do not couple eigenbundles \mathcal{V}_q with *different* q . Hence we may fix q and discuss the geometry in that sector. In other words, we get a *family* of tt^* geometries labelled by the value of q . In the vacuum eigenbundle with $q = 1$ (if it exists at all), we see from eqn.(3.86) that we may diagonalize simultaneously the lattice translation operators M_1 and M_2 . Calling, as before, $\exp(2\pi i x_i)$ their respective eigenvalues, we get the standard commutative tt^* geometry (triple-periodic instantons). If we deform the parameter q away from its ‘classical’ value $q \neq 1$, the lattice translation operators, M_1 and M_2 , do not commute any longer, and we get triple-periodic instanton on a *non-commutative* deformation of the previous geometry, namely on the quantum torus obtained by deformation *à la* Moyal of the usual commutative torus

$$e^{2\pi i x_2} e^{2\pi i x_1} = q e^{2\pi i x_1} e^{2\pi i x_2}.$$

The value of q . The obvious question at this point is what is the physically natural value of the non-commutativity parameter q . Although geometrically it makes sense to speak of generic $q \in \mathbb{C}^*$, we expect that the physical problem selects a definite value for q . Leaving a more complete analysis for future work, here we focus on the simplest thimble amplitudes for the 4d theories modelled by the effective superpotential (3.75), in the UV asymmetric limit defined at the end of §. 2. In this limit the vacuum wave functions may be identified with $\exp(-\zeta W) \xi_a$ where ξ_a are closed forms dual to the Lefschetz thimble cycles D_a . If we define the branes D_a so that the corresponding cycles are invariant under the monodromy along the path

ℓ , then the action of M_ℓ on these vacua will be given by its action on the factor $\exp(-\zeta W)$ and hence

$$q e^{-\zeta W} = M_\ell e^{-\zeta W} \equiv e^{2\pi i \zeta \mu'} e^{-\zeta W}. \quad (3.88)$$

In particular, at $\zeta = 1$ we get

$$q = e^{2\pi i \mu'}. \quad (3.89)$$

As we will mention in section 8 this result is in agreement with what one finds for the tt^* geometry arising in 4d models.

4 Spectral Lagrangian manifolds

To the tt^* geometry of any $(2, 2)$ system there is associated a spectral Lagrangian manifold. The details vary slightly in the various cases so we treat them one at a time.

4.1 Ordinary models

For an ordinary $(2, 2)$ model (finitely many vacua, globally defined superpotential) the tt^* equations for one complex coupling t reduce to the Hitchin equations

$$\bar{D}_t C_t = [D_t, \bar{D}_t] + [C_t, \bar{C}_t] = 0, \quad (4.1)$$

which, in particular, imply that the eigenvalues $\lambda(t)_j$ of the matrix C_t are holomorphic functions of t . The spectral curve encodes the holomorphic functions $\lambda(t)_j$; it is simply the curve in \mathbb{C}^2

$$\det(C_t(t) - s) = 0. \quad (4.2)$$

In the case of several couplings t_i ($i = 1, 2, \dots, g$), the tt^* equations say that the various C_i 's *commute* and are covariantly holomorphic, $\bar{D}_j C_i = 0$. Then the C_i 's may be simultaneously diagonalized (more generally, simultaneously set in the Jordan canonical form) and moreover the corresponding eigenvalues depend holomorphically on the t_j 's. The spectral manifold \mathcal{L} encodes the g -tuples of eigenvalues of the C_i 's associated to a common eigenvector ψ , that is,

$$\mathcal{L} = \left\{ (s_1, \dots, s_g, t_1, \dots, t_g) \in \mathbb{C}^{2m} \mid \exists \psi \neq 0 \text{ s.t. } (s_i - C_i(t_j))\psi = 0 \right\}. \quad (4.3)$$

Clearly $\mathcal{L} \subset \mathbb{C}^{2g}$ is a complex submanifold. It is also a Lagrangian submanifold with respect to the holomorphic symplectic form

$$\omega = \sum_i ds_i \wedge dt_i. \quad (4.4)$$

To see this, notice that the spectral manifold is purely a property of the underlying holomorphic TFT. We may assume to be at a generic point in parameter space

where the chiral ring \mathcal{R} is semisimple. Then the eigenvalue of C_i associated to the k -th indecomposable idempotent of \mathcal{R} is simply $\partial C_{kk}/\partial t_i$ where C is the tt^* matrix introduced in ref.[27]. (In the particular case of a LG model, C_{kk} is just $W^{(k)}$, the superpotential evaluated on the k -th classical vacuum configuration). Hence, locally on the k -th sheet, the equations of \mathcal{L} take the form

$$s_i = \frac{\partial}{\partial t_i} C_{kk}, \quad (4.5)$$

and \mathcal{L} is a Lagrangian submanifold. For a LG model it may be simply written as

$$s_i = \partial W(Y_a, t_i)/\partial t_i \quad \partial W(Y_a, t_i)/\partial Y_a = 0. \quad (4.6)$$

The spectral manifold gives half of the spectral data which labels uniquely a solution of Hitchin's equations or of the higher-dimensional generalizations. The other half is a holomorphic line bundle on \mathcal{L} . The line bundle can be defined as the eigenline associated to each point of the spectral manifold.

4.2 Periodic models

Let us consider first the case in which we have a single triplet of parameters (a complex t together with a vacuum angle x). Just as in the ordinary case, the spectral curve \mathcal{L} encodes the spectrum of the linear operator $C_t(t)$ which depends holomorphically on t . Hence the spectral curve is given by the same Hitchin formula as before, eqn.(4.2)

$$\mathcal{L} : \text{Det}[C_t(t) - s] = 0. \quad (4.7)$$

The only novelty is that now $C_t(t)$ is not a finite matrix, but rather a linear differential operator of the form

$$\frac{\partial}{\partial x} + B_t(t), \quad (4.8)$$

and the matrix determinant gets replaced by a functional determinant in the Hilbert space $L^2(S^1, dx) \otimes \mathbb{C}^n$ of vector functions of period 1. The expression

$$\text{Det}[C_t(t) - s] \equiv \text{Det}[\partial_x + B_t(t) - s] \quad (4.9)$$

is simply the partition function, twisted by $(-1)^F$, of a system of one-dimensional free Dirac fermions with mass matrix $B_t(t) - s$. Hence the spectral curve has equation

$$\text{Det}[\partial_x + B_t(t) - s] = \prod_j (e^{(\lambda_j(t)-s)/2} - e^{(s-\lambda_j(t))/2}) = 0, \quad (4.10)$$

where $\lambda_j(t)$ are the eigenvalues of $B_t(t)$. Usually one writes this equation in the form

$$\det[e^s - e^{B_t(t)}] = 0. \quad (4.11)$$

Since $B_t(t)$ (say for a periodic LG model) is a diagonal matrix whose kk -entry is $\partial_t W$ evaluated on the k -th (reference) classical vacuum (cfr. eqn.(3.6)), eqn.(4.11) has the same form as the ordinary Hitchin curve (4.2) but with all quantities exponentiated. This ‘exponentiation’ is no mystery: the two formulae (4.2) and (4.11) are identical provided one keeps into proper account the role of the Hilbert space $L^2(S^1, dx)$. Thus the spectral manifold is a Lagrangian sub manifold in $\mathbb{C} \times \mathbb{C}^*$.

The case of several triplets of couplings t_i, x_i , ($i = 1, \dots, g$) is similar. The spectral manifold \mathcal{L} is again given by the usual tt^* equation (4.3), with the only specification that the C_i are differential operators and ψ is a non-zero eigenvector in

$$\mathbb{C}^n \otimes L^2((S^1)^g, dx_1 \wedge \dots \wedge dx_g), \quad (4.12)$$

(n being the number of vacua in a reference sheet). The eigenvector equations for ψ have the form

$$\left(\partial_{x_r} + B_r(t) - s_r\right)\psi = 0, \quad r = 1, \dots, g, \quad (4.13)$$

whose non-zero solutions are

$$\psi = \exp\left(\sum_r x_r (s_r - B_r)\right)\psi_0, \quad 0 \neq \psi_0 \in \mathbb{C}^n, \quad (4.14)$$

(we have used the fact that the matrices B_r commute). The condition that ψ belongs to the Hilbert space (4.12) may be written in the form

$$\left\{ (e^{s_1}, \dots, e^{s_g}, t_1, \dots, t_g) \in (\mathbb{C}^*)^g \times \mathbb{C}^g \mid \exists 0 \neq \psi_0 \in \mathbb{C}^n \text{ s.t. } (e^{s_i} - e^{B_i(t_j)})\psi_0 = 0 \right\} \quad (4.15)$$

which is the same as the ‘exponentiation’ of the spectral manifold equations.

Eqn.(4.15) gives the spectral manifold equations for the general periodic case. Again, $\mathcal{L} \subset (\mathbb{C}^*)^m \times \mathbb{C}^m$ is a complex submanifold which is also Lagrangian for the symplectic structure ($S_i \equiv e^{s_i}$)

$$\sum_i \frac{dS_i}{S_i} \wedge dt_i. \quad (4.16)$$

In view of the definition of the matrices B_r , eqn.(3.6), the proof is the same as in the ordinary case, and will be omitted.

In particular, for a periodic LG model (with periodic couplings), eqn.(4.6) gets replaced by its ‘exponentiated’ version

$$\exp(s_i) = \exp\left(\partial W(Y_a, t_i)/\partial t_i\right) \quad \partial W(Y_a, t_i)/\partial Y_a = 0. \quad (4.17)$$

In later sections we will encounter special periodic models which arise from the compactification of 3d gauge theories, for which the couplings t_i are also periodic. In

that case, the spectral manifold is naturally defined in $(\mathbb{C}^*)^{2g}$ rather than $(\mathbb{C}^*)^g \times \mathbb{C}^g$, with symplectic form $(S_i \equiv e^{s_i}, T_i \equiv e^{t_i})$

$$\sum_i \frac{dS_i}{S_i} \wedge \frac{dT_i}{T_i}. \quad (4.18)$$

We will denote these models as “3d periodic models”.

4.3 Doubly-periodic models

The doubly-periodic case is similar, except that the C_i 's are now differential operators of the form

$$C_i = \partial_{x_{1,i}} + \rho_i \partial_{x_{2,i}} + B_i. \quad (4.19)$$

We consider first the case of just four parameters (a complex t and two vacuum angles x_1 and x_2). Assuming $\text{Im } \rho > 0$, we introduce a complex coordinate ζ such that

$$(\rho - \bar{\rho}) \partial_\zeta = \partial_{x_1} + \rho \partial_{x_2}, \quad (4.20)$$

which takes values in a torus of periods 1 and $\tau \equiv -\bar{\rho}$. The spectral curve takes the form

$$\text{Det} \left[\partial_\zeta + \frac{B-s}{\rho - \bar{\rho}} \right] = 0. \quad (4.21)$$

The LHS is now the partition function of a system of 2d chiral fermions on a torus of modulus τ coupled to a background gauge connection $A_\zeta = (B-s)/(\rho - \bar{\rho})$. The spectral curve may be then written as

$$\det \theta_1 \left(\frac{s-B}{\rho - \bar{\rho}} \mid -\bar{\rho} \right) = 0, \quad (4.22)$$

where $\theta_1(z \mid \tau)$ is the usual theta function.

In the general case the spectral manifold is

$$\mathcal{L} \equiv \left\{ (s_i, t_i) \in \mathcal{A} \times \mathbb{C}^g \mid \exists 0 \neq \psi_0 \in \mathbb{C}^n \text{ s.t. } \Theta(s_i - B_i) \psi_0 = 0 \right\} \quad (4.23)$$

where \mathcal{A} is the Abelian variety where the angular variables are valued in, and Θ is the basic theta-function for \mathcal{A} . All other cases (non-periodic, single periodic) may be obtained as degenerate limits of this expression. For instance, eqn.(4.11) corresponds to \mathcal{A} being an elliptic curve with an ordinary node, while (4.2) to an elliptic curve with a cusp.

4.4 Action of $\text{Sp}(2m, \mathbb{A})$ on the spectral manifolds

In all cases the spectral manifold \mathcal{L} is a (holomorphic) Lagrangian submanifold¹⁴ of a holomorphic symplectic manifold \mathcal{S} which is also an Abelian group. It makes sense

¹⁴ To avoid misunderstandings, we stress that \mathcal{L} is defined as a *submanifold*, that is, as an abstract manifold together with a Lagrangian embedding $\mathcal{L} \hookrightarrow \mathcal{S}$; in particular, this means a definite choice of which coordinates we call t_i 's (*i.e.* which coordinates are interpreted as couplings of the QFT).

to consider the action on \mathcal{L} of ambient symplectomorphisms $\mathcal{U}: \mathcal{S} \rightarrow \mathcal{S}$. In order for the transformed manifold $\mathcal{U}(\mathcal{L})$ to have a spectral interpretation¹⁵, \mathcal{U} must be a group homomorphism of \mathcal{S} as well as a symplectomorphism.

In the case of non-periodic models, \mathcal{S} is the additive group \mathbb{C}^{2g} , and the group of symplectic homomorphisms is $\mathrm{Sp}(2g, \mathbb{C})$ acting on (t_i, s_j) in the obvious linear way. For periodic models, the group of transformations compatible with the periodicities is much reduced. An important exception are 3d periodic models, for which we can consider $\mathrm{Sp}(2g, \mathbb{Z})$ transformations, which preserve the periodicities of the s_i and t_i variables.

For other periodic models, beyond the boring transformations of the form $t \rightarrow gt$, $s \rightarrow g^{-1}s$, we only have dualities between different types of spectral manifolds. For example, an S transformation $s \rightarrow t$, $t \rightarrow -s$ may relate the spectral curves for a Hitchin system on a cylinder and the spectral curve of a periodic monopole: the former has a periodic t and non-periodic s , the latter has a periodic s and a non-periodic t .

The symplectic transformations will act both on the spectral manifold \mathcal{L} and on the associated line bundle. Because of the one-to-one correspondence between the spectral data and the tt^* geometry, one may suspect the symplectic action should lift to an action over the tt^* geometries, and hence on the corresponding supersymmetric physical theories. Indeed, the lift coincides with the well-known notion of Nahm transform. We will discuss the Nahm transform and its relation to the tt^* geometry in the next section. For now, we would like to examine a more direct physical interpretation of the symplectic action.

Let's start with a standard (2, 2) LG model, defined by some superpotential $W(Y_a, t_i)$. We can promote the parameters t_i to chiral fields P_i , and consider a new LG model with superpotential

$$W(Y_a, P_i, \tilde{t}_i) = W(Y_a, P_i) + \sum_i \tilde{t}_i P_i \quad (4.24)$$

The F-term equations give us

$$\tilde{t}_i + \partial_{P_i} W(Y_a, P_i) = 0 \quad \partial_{Y_a} W(Y_a, P_i) = 0 \quad \tilde{s}_i = P_i \quad (4.25)$$

Thus the spectral manifold of the new model is related to the spectral manifold of the old model by the basic symplectic transformation $\tilde{s}_i = t_i$, $\tilde{t}_i = -s_i$.

¹⁵ More precisely, we mean the following: when \mathcal{U} is a group homomorphism, besides a symplectomorphism, one canonically identifies the Lagrangian submanifold $\mathcal{U}(\mathcal{L})$ as the spectral manifold of the tt^* geometry of another supersymmetric QFT, thus inducing a group action on the field theories themselves. It would be interesting to see whether one can interpret in a similar way the action of more general symplectomorphism.

This can be thought of as a functional Fourier transform at the level of chiral super-fields, acting on path integrals as

$$Z[t_i] \rightarrow \tilde{Z}[\tilde{t}_i] = \int DP^g e^{\int d^2\theta \sum_i \tilde{t}_i P_i} Z[P_i] \quad (4.26)$$

It is not hard to check that repeating this step, brings us back to the original theory, so this is an order 2 operation.

More generally, we can consider a model with superpotential

$$W(Y_a, P_i, \tilde{t}_i) = W(Y_a, P_i) + \sum_{ij} A_{ij} \tilde{t}_i \tilde{t}_j + B_{ij} \tilde{t}_i P_j + C_{ij} P_i P_j \quad (4.27)$$

to obtain more general symplectic transformations.

Inspired by the Fourier transform, we can describe the action of $\mathrm{Sp}(2g, \mathbb{C})$ on the $(2, 2)$ theories in the following way. Let $\omega_s \equiv (q_1, q_2, \dots, q_g, p^1, \dots, p^g)$ be usual canonical operators acting in the Hilbert space $L^2(\mathbb{R}^g)$, and let

$$\mathcal{U} = \left(\begin{array}{c|c} A & B \\ \hline C & D \end{array} \right) \in \mathrm{Sp}(2g, \mathbb{C}). \quad (4.28)$$

Since $\mathrm{Sp}(2g, \mathbb{C})$ is the complexification of $\mathrm{USp}(2g)$, the linear transformation

$$\omega_s \longmapsto \mathcal{U}_{st} \omega_t, \quad (4.29)$$

is the complexification of an unitary transformation of $L^2(\mathbb{R}^g)$, and it is implemented by an invertible operator U . Consider its kernel in the Schroedinger representation

$$\exp\left[\kappa(q'_i, q_j; \mathcal{U})\right] = \langle q'_i | U | q_j \rangle. \quad (4.30)$$

Then the action of $\mathcal{U} \in \mathrm{Sp}(2g, \mathbb{C})$ on the space of $(2, 2)$ theories (modulo D -terms) is given in terms of effective superpotentials as

$$W(t_i) \longmapsto W_{\mathcal{U}}(t'_i), \quad (4.31)$$

where

$$\begin{aligned} \exp\left(-\int d^2z d^2\theta W_{\mathcal{U}}(t'_i)\right) &= \\ &= \int_{\substack{\text{TFT path} \\ \text{integral}}} [dP_j] \exp\left(-\int d^2z d^2\theta \left[W(P_j) - \kappa(t'_i, P_j; \mathcal{U})\right]\right). \end{aligned} \quad (4.32)$$

We claim that the spectral manifold $\mathcal{L}_{\mathcal{U}}$ of the transformed $(2, 2)$ model $W_{\mathcal{U}}(t'_i)$, as defined is precisely $\mathcal{U}(\mathcal{L})$, where $\mathcal{U}: \mathbb{C}^{2g} \rightarrow \mathbb{C}^{2g}$ is the linear map

$$\begin{aligned} t'_i &= A_{ij} t_j + B_{ij} s_j, \\ s'_i &= C_{ij} t_j + D_{ij} s_j. \end{aligned} \quad (4.33)$$

In this definition we do not specify the precise form of the D-terms for the new theory. Rather, we consider the action of the symplectic transformation on the space of $(2, 2)$ QFTs modulo D-term deformations, including possibly integrating away some of the degrees of freedom if possible. In fact, the detailed form of the D -terms is irrelevant for tt^* , and we are interested not in the full effective action $S[P^i]$ but only in its topologically non-trivial part¹⁶ $\int d^2\theta W(P^i)_{\text{dual}}$.

It is not hard to extend this type of construction to the other types of theories with four super-charges we consider in this paper, by seeking transformations which reduce to the above symplectic transformations at the level of a low-energy $(2, 2)$ LG description. The most important example are the periodic theories associated to Abelian flavor symmetries. If we gauge some flavor symmetries, we end up promoting the twisted masses μ_a to (twisted) chiral super fields σ_a with linear (twisted) F-term couplings $\sum_a t_a \sigma_a$ to the FI terms. Thus we recover the symplectic transformation relating periodic monopole geometries and Hitchin systems on cylinders.

In the special case of 3d periodic geometries, which arise from 3d $\mathcal{N} = 2$ gauge theories compactified on a circle of finite size to a 2d theory with $(2, 2)$ symmetry, the $\text{Sp}(2g, \mathbb{Z})$ action on the spectral curve lifts all the way to Witten's $\text{Sp}(2g, \mathbb{Z})$ [77] action on 3d SCFTs equipped with a $U(1)^g$ flavor symmetry, generated by the operations of gauging a flavor symmetry and of adding a background CS couplings. See [46] for a review and further references.

4.5 A higher dimensional perspective

The example of the 3d $\mathcal{N} = 2$ gauge theories is actually very instructive. Although Witten's $\text{Sp}(2g, \mathbb{Z})$ [77] action can be defined directly in 3d terms, it is more elegantly described as the action of four-dimensional electric-magnetic duality on half-BPS boundary conditions for a free Abelian gauge theory with eight supercharges [78].

It is simple and instructive to pursue this analogy here. Let's go back again to the 2d $(2, 2)$ LG models with some parameters t_i which enter linearly in the superpotential $W(Y_a, P_i)$. This time, instead of promoting the t_i to 2d chiral super fields, we can promote them to the boundary values of some free 3d hypermultiplets.

More precisely, consider a set of free 3d hypermultiplets, decomposed into pairs of complex scalars (P_i, \tilde{P}_i) , rotated into each other by an $\text{Sp}(2g)$ flavor symmetry. The simplest half-BPS boundary condition B for free hypers sets Dirichlet b.c. for the \tilde{P}_i and Neumann for the P_i . The boundary value $P_i|_{\partial}$ of the P_i behaves as a 2d chiral multiplet. If we add the 2d LG theory at the boundary and couple it to the 3d system through a superpotential $W(Y_a, P_i|_{\partial})$ we obtain a deformed half-BPS boundary condition, which roughly sets $\tilde{P}_i = \partial_{t_i} W$. In other words, the boundary condition forces the hypermultiplet scalars $(P_i, \tilde{P}_i)|_{\partial}$ at the boundary to lie on the

¹⁶ We write the non-trivial part of the action as an F -term. Of course, it may be a twisted F -term as well. The examples in appendix A of [7] have actually twisted dual superpotentials.

spectral Lagrangian manifold \mathcal{L} , with the identification $(P_i, \tilde{P}_i)|_{\partial} = (t_i, s_i)$ (see [45] for an higher-dimensional version of this construction).

Up to D-terms, the map from 2d theories to half-BPS boundary conditions is invertible. Define a boundary condition \tilde{B} by Dirichlet b.c. for the P_i and Neumann for the \tilde{P}_i . If we put the 3d theory on a segment, with our boundary condition at one end and \tilde{B} at the other end, we recover the original 2d theory. At this point, the symplectic action on 2d theories has an obvious interpretation in the language of half-BPS boundary conditions: it is the action of the (complexified) hypermultiplet flavor symmetries on half-BPS boundary conditions.

It is easy to extend this to other situations:

- A 2d $(2, 2)$ theory with Abelian flavor symmetry $U(1)^g$ can be transformed into a boundary condition for a free $\mathcal{N} = 4$ 3d gauge theory: start with Neumann b.c. for the gauge fields and couple them to the 2d degrees of freedom at the boundary. The inverse operation involves a segment with Dirichlet b.c. for the gauge field. If we dualize the 3d gauge field we obtain an hypermultiplet valued in $\mathbb{C} \times \mathbb{C}^*$ and proceed as before. The duality transformation acts on boundary conditions as a gauging/ungauging of the Abelian flavor symmetry. This is related to the Nahm transform relating periodic monopoles and periodic Hitchin systems.
- A 3d $\mathcal{N} = 2$ theory with Abelian flavor symmetry $U(1)^g$ can be transformed into a boundary condition for a free $\mathcal{N} = 2$ 4d gauge theory. The bulk theory has an $\text{Sp}(2g, \mathbb{Z})$ group of electric-magnetic duality transformations which acts on boundary conditions. This is related to the Nahm transform relating doubly periodic monopoles.
- A 4d $\mathcal{N} = 1$ theory with Abelian flavor symmetry $U(1)^g$ can be transformed into a boundary condition for a free $\mathcal{N} = 1$ 5d gauge theory. The 5d gauge theory can be dualized into a self-dual two-form. The duality transformation acts on boundary conditions as a gauging/ungauging of the Abelian flavor symmetry. This is related to the Nahm transform relating triply periodic monopoles and triply periodic instantons.

Some of these examples we already encountered. Some we will encounter in the next sections. It is useful to point out that in this setup the bulk theory is always free and thus well-defined even in 5d.

4.6 Generalized Nahm's transform and the tt^* geometry

In the previous two sections we have seen that the tt^* equations for ordinary, periodic, and doubly-periodic systems are the higher dimensional generalizations of, respectively, Hitchin, monopole, and self-dual Yang-Mills equations. All these geometries

get unified in the concept of hyperholomorphic connections on $U(N)$ -bundles over a hyperKähler manifold \mathcal{M} [16–19], which is possibly invariant under a suitable group of continuous isometries of \mathcal{M} , which reduces the number of coordinates (parameters) on which the geometry effectively depends, as well as of discrete isometries which lead to periodicities of various kinds.

An important tool in the theory of hyperholomorphic bundles and connections is the *generalized Nahm transform* [28–34], which relates hyperholomorphic bundles on certain dual pairs of hyperKähler manifolds $(\mathcal{M}, \mathcal{X})$. The duality typically proceeds by defining a family of Dirac operators \mathcal{D}_x on \mathcal{M} parameterized by a point $x \in \mathcal{X}$ and then constructing an hyperholomorphic connection on \mathcal{X} from the kernel of the Dirac operators. A prototypical example of generalized Nahm transform is the Fourier–Mukai transform [34, 35] where \mathcal{M} and \mathcal{X} are a dual pair of Abelian varieties.

Well known simple examples of the Nahm transformation relate monopole solutions on \mathbb{R}^3 to solutions of Nahm equations, periodic monopole solutions to solutions of Hitchin systems on a cylinder, instantons on \mathbb{R}^4 to solutions of algebraic equations, etc. In all cases where the spectral data can be defined, the generalized Nahm transform acts as a symplectic transformation on the spectral manifold.

It is not hard to produce a long list of pairs of physical systems $(T_{\mathcal{M}}, T_{\mathcal{X}})$ with four supercharges with the property that the corresponding tt^* geometries are hyperholomorphic connections related by a Nahm transformation. This is particularly easy because many examples of Nahm transformations arise in well-known systems of intersecting D-branes in string theory. In all cases the two theories $(T_{\mathcal{M}}, T_{\mathcal{X}})$ are always related as we described above, by promoting some background couplings in one theory to dynamical degrees of freedom in the other theory. For example, if a periodic monopole geometry is associated to a $U(1)$ flavor symmetry of $T_{\mathcal{M}}$, then $T_{\mathcal{X}}$ will be obtained by gauging that flavor symmetry, and the tt^* geometry associated to the corresponding FI parameter gives the dual solution of a Hitchin system on a cylinder.

We would like to explain now briefly that the generalized Nahm transformation always coincides with the calculation of the tt^* geometry for a certain physical system and that the relation with a Fourier–Mukai transform also has a natural physical interpretation in the language of half-BPS boundary conditions for theories with eight supercharges.

Much of the structure of the tt^* geometry follows directly from general considerations about supersymmetric quantum mechanics (SQM) with four supercharges. In general, we have a \mathbb{Z}_2 -graded Hilbert space \mathcal{H} , with grading operator $(-1)^F$, and a family of four odd Hermitian supercharges $\{Q_a(t)\}_{t \in \mathcal{X}}$, $a = 1, \dots, 4$, depending on F-term-type parameters t taking value in some space \mathcal{X} . The $Q_a(t)$'s satisfy the SUSY algebra

$$\{Q_a(t), Q_b(t)\} = \delta_{ab} H(t). \quad (4.34)$$

The tt^* geometry computes the Berry connection on the bundle over \mathcal{X} of the zero-eigenvectors of $H(t)$, which, as reviewed in the previous sections, is a hyperholomorphic connection (or a dimensional reduction thereof).

There is a simple interpretation of the Berry connection on the bundle of vacua. If we promote the parameters t to dynamical superfields, with a very slow dynamics, the Berry connection encodes the effect of integrating away the original degrees of freedom in a Born-Oppenheimer approximation protected by supersymmetry. Remember that a massless Euclidean Dirac operator \mathcal{D} , coupled to a gauge/gravitational background, in *even* space-time dimensions $D = 2m$, defines a SQM system with two supercharges Q_1, Q_2 under the dictionary

$$\gamma_5 \leftrightarrow (-1)^F, \quad \mathcal{D} \leftrightarrow Q_1, \quad i\gamma_5 \mathcal{D} \leftrightarrow Q_2, \quad \mathcal{D}^2 \leftrightarrow H. \quad (4.35)$$

The supersymmetry of this SQM system enhances to 4 supercharges precisely if $D = 4n$, the gravitational background is hyperKähler, and the gauge connection is *hyperholomorphic* (in the particular case of $D = 4$ this means (anti)self-dual). Indeed, under these conditions the Hamiltonian \mathcal{D}^2 is invariant under a $\mathrm{Sp}(2)$ R -symmetry, which geometrically corresponds to the centralizer of the holonomy group in $SO(D)$. Thus the tt^* geometry encodes precisely the data required to define a low-energy supersymmetric dynamics on the parameter space \mathcal{X} of the original theory.

Parsing through the definitions of the generalized Nahm transform (or even of the standard Nahm transform) makes it clear that the basic steps involving the Dirac operators \mathcal{D}_x simply coincides with the calculation of the Berry connection for the $N = 4$ SQM associated to these Dirac operators. In other words, the Nahm transform emerges as expected from making the parameters of an $N = 4$ SQM dynamical.

At this point, we can mimic our previous discussion by making the parameters t dynamical not as 1d degrees of freedom, but as boundary values of 2d degrees of freedom. We can add a direction to our system, and promote our 1d system with four supercharges to an half-BPS boundary of a 2d system with eight supercharges. We can consider a 2d $(4, 4)$ non-linear sigma model with target space \mathcal{X} defined on a half-space, and couple the boundary values of the 2d degrees of freedom T_i to the original 1d $N = 4$ SQM in the obvious way. This produces a half-BPS ¹⁷ brane \mathcal{B} for the 2d $(4, 4)$ non-linear sigma model.

This brane obviously captures the same protected information as the original 1d SQM. For example, we can consider the 2d theory on a segment, with \mathcal{B} boundary conditions at one end and a $D0$ brane at the other end, i.e. Dirichlet boundary conditions $T_i = t_i$ at the other end. This quantum mechanical system has the same ground states and Berry connection as the original system.

¹⁷More precisely a (B, B, B) brane, a brane which is type B in each complex structure for the target.

On the other hand, we can pick a different D-brane \mathcal{D} at the other end of the segment, and thus find a different low energy $N = 4$ quantum-mechanical system and a different tt^* geometry associated to the pair $(\mathcal{B}, \mathcal{D})$. For example, we could pick \mathcal{D} to be a space-filling brane in \mathcal{X} . Then the 1d system is simply the SQM on \mathcal{X} . If \mathcal{X} has a mirror \mathcal{M} , we can pick a family of branes \mathcal{D}_m dual to D0 branes in \mathcal{M} and thus obtain a family of SQM whose Berry connection is a hyperholomorphic connection on \mathcal{M} .

This is just the action of mirror symmetry on half-BPS branes in the $(4, 4)$ non-linear sigma model. Mirror symmetry can be interpreted as a Fourier–Mukai transformation, with a kernel which defines a special BPS “duality interface” between the \mathcal{X} and \mathcal{M} non-linear sigma models.

4.7 An explicit example

The above structures may be elementarily illustrated in a 1d $\mathcal{N} = 4$ Landau–Ginzburg model which, as discussed above, may be identified with a Dirac operator coupled to a hyperholomorphic connection. For simplicity we assume there is just one chiral field Y . Identifying the SQM Hilbert space with the space of square-integrable differential forms on \mathbb{C} , the supercharges in the Schroedinger representation are [36]

$$\bar{Q} = \bar{\partial} + \partial W \wedge, \quad Q = \partial + \bar{\partial} \bar{W} \wedge \quad (4.36)$$

together with their Hermitian conjugates. The vacuum wave-functions are 1-forms

$$\psi_1^j dY + \psi_2^j d\bar{Y}, \quad (4.37)$$

and the solutions to the zero-energy Schroedinger equation $H\Psi = 0$ may be identified with solutions of the negative-chirality Euclidean Dirac equation in $\mathbb{R}^4 \simeq \mathbb{C}^2$,

$$\frac{1}{2}(1 - \gamma_5)\not{D}\Psi = 0, \quad (4.38)$$

or, more explicitly,

$$\begin{pmatrix} \partial_{\bar{Y}} & \partial_{\bar{Z}} - \partial_Y W \\ \partial_Z + \partial_{\bar{Y}} \bar{W} & -\partial_Y \end{pmatrix} \begin{pmatrix} \psi_1^j \\ \psi_2^j \end{pmatrix} = 0, \quad (4.39)$$

which are invariant under the translations in the additional complex coordinate Z (which may be assumed to take value in a compact torus). The Dirac operator in eqn.(4.39) is coupled to a $U(1)$ connection on \mathbb{C}^2

$$A_Z = \partial_{\bar{Y}} \bar{W}, \quad A_Y = 0. \quad (4.40)$$

which is self-dual. Indeed¹⁸,

$$\begin{aligned} \not{D}^- \not{D}^+ &\equiv \begin{pmatrix} \partial_{\bar{Y}} & \partial_{\bar{Z}} - \partial_Y W \\ \partial_Z + \partial_{\bar{Y}} \bar{W} & -\partial_Y \end{pmatrix} \begin{pmatrix} -\partial_Y & -\partial_{\bar{Z}} + \partial_Y W \\ -\partial_Z - \partial_{\bar{Y}} \bar{W} & \partial_Y \end{pmatrix} = \\ &= \left(-\partial_{\bar{Z}} \partial_Z - \partial_{\bar{Y}} \partial_Y + |\partial_Y W|^2 \right) \mathbf{1}_2. \end{aligned} \quad (4.41)$$

¹⁸ Here $\not{D}^\pm = (1 - \gamma_5)\not{D}/2$.

Given a family $A_\mu(t)$ of self-dual $U(N)$ connections depending on parameters t_i , the Nahm procedure requires to solve the chiral Dirac equation

$$(1 - \gamma_5)\gamma^\mu(\partial_\mu + A_\mu(t))\Psi^j = 0. \quad (4.42)$$

In the present LG example the connection is Abelian, $N = 1$, and the t_i 's are the couplings in the superpotential W . The normalizable zero-modes Ψ^j , which are automatically invariant by translation in the dumb coordinate Z , define a bundle over parameter space which is endowed with the natural induced connection. By definition, this is the Nahm transformed connection of the LG one (4.40). Since the zero-modes Ψ^j are precisely the SUSY vacua, the (translationally invariant) Nahm bundle is the SUSY vacuum bundle, whose rank k is the Witten index of the LG model. Thus the Nahm connection coincides with the tt^* one. By general tt^* theory, the connection is hyperholomorphic and invariant by translation in half the directions.

Now we take this tt^* geometry as the definition of a new $\mathcal{N} = 4$ SQM system, by viewing the Dirac operators coupled to the tt^* Berry connection as the new supercharges.

For instance, for the one-dimensional family of LG models $W(Y) = W_0(Y) - PY$, parametrized by the coupling P , the supercharge corresponding to \mathcal{D}^- is

$$\mathcal{D}^- \Big|_{\text{dual}}^{tt^*} = \begin{pmatrix} \bar{D}_P & -C_P + Y \\ \bar{C}_P - \bar{Y} & -D_P \end{pmatrix}, \quad (4.43)$$

where now Y is a free parameter (a dual coupling). Note that the connection in eqn.(4.43) satisfies the tt^* equations (with the same tt^* metric) for all values of Y . The equation for the SUSY vacua of the dual theory

$$Q \Big|_{\text{dual}}^{tt^*} \Psi \equiv \mathcal{D}^- \Big|_{\text{dual}}^{tt^*} \Psi = 0 \quad (4.44)$$

has a single *normalizable* solution which defines the vacuum line bundle \mathcal{L} over the space $\mathbb{C}_Y \times \mathbb{C}_Z$ which is invariant by translation in the fictitious Z direction. The tt^* connection on \mathcal{L} is just JdW , where J is the quaternionic imaginary unit in $\mathbb{H} \simeq \mathbb{C}^2$. We have thus recovered the original LG model.

We close this subsection noticing that while eqn.(4.44) has (for any given value of Y) a single *normalizable* solution, it has several physically interesting *non-normalizable* solutions. Indeed, let Π be a D -brane amplitude of the original LG model with phase $\zeta = e^{i\theta}$. It is easy to check that the ‘right spinor’

$$\Psi = \begin{pmatrix} D_t \Pi \\ \bar{C}_t \Pi \end{pmatrix} \equiv -\zeta \begin{pmatrix} C_t \Pi \\ \bar{D}_t \Pi \end{pmatrix}, \quad (4.45)$$

satisfies the tt^* -dual chiral Dirac equation at $Y = 0$

$$\mathcal{D}^- \Big|_{\text{dual}}^{tt^*} \Psi = 0. \quad (4.46)$$

4.8 Review of the flat Nahm transform in $\mathbb{R}^{4n-k} \times T^k$

The Nahm transform was originally introduced as a generalization of the ADHM construction of $U(N)$ self-dual connections in \mathbb{R}^4 [37]. One looks for instantons in the flat hyperKähler space \mathbb{R}^4 which are invariant under a group of translations $\Lambda \subset \mathbb{R}^4$ [33]. As a group, Λ is isomorphic to $\mathbb{R}^k \times \mathbb{Z}^l$ for some k, l with $k+l \leq 4$; the Λ -invariant instantons may be seen as field configurations of a $(4-k)$ -dimensional theory which are periodic in l directions, or equivalently theories defined on the quotient $(4-k)$ -fold $M \equiv \mathbb{R}^4/\Lambda$. It is well known that for $k = 1, 2, 3$ and 4 , the self-dual Yang Mills equations reduce, respectively, to monopole [38], Hitchin [6], Nahm [28, 29], and the ADHM algebraic equations [37]. The monopoles (resp. Hitchin, or Nahm fields) are then taken to be periodic in l directions.

Let $\Lambda^\vee \subset (\mathbb{R}^4)^\vee$ be the dual group of Λ , *i.e.*

$$\Lambda^\vee = \{\alpha \in (\mathbb{R}^4)^\vee \mid \alpha(\lambda) \in \mathbb{Z} \ \forall \lambda \in \Lambda\} \simeq \mathbb{R}^{4-k-l} \times \mathbb{Z}^l. \quad (4.47)$$

The (flat) Nahm transform maps a $U(N)$ instanton on \mathbb{R}^4 invariant under Λ into a $U(K)$ instanton on the dual $(\mathbb{R}^4)^\vee$ invariant under the dual group Λ^\vee [33], which for $k = 0, 1, 2, 3, 4$ concretely means a l -fold periodic solution to, respectively, the ADHM, Nahm, Hitchin, monopole, and YM self-dual equations. The dual solutions are allowed to have singularities of the appropriate kind [33].

Comparing with section 3, we see that the one coupling tt^* geometry corresponds to this \mathbb{R}^4/Λ setting with

- $\Lambda = \mathbb{R}^2$ for ordinary $(2, 2)$ models;
- $\Lambda = \mathbb{R} \times \mathbb{Z}$ for periodic models [39];
- $\Lambda = \mathbb{R} \times \mathbb{Z}^2$ for 3d version of periodic models [40]
- $\Lambda = \mathbb{Z}^2$ for doubly periodic models [41].

We review the \mathbb{R}^4/Λ construction for Λ a rank 4 lattice, so that M is a torus T^4 . All other cases, including the ones relevant for this paper, may be obtained from the T^4 one by sending some periods of the torus to either zero or infinity. The dual torus will be denoted as \tilde{T}^4 and its coordinates as \tilde{t}_μ . By definition, the dual torus \tilde{T}^4 , which can be viewed as T-dual of T^4 , parametrizes the family of flat Abelian connections on the original T^4 . Given a self-dual $U(N)$ connection A on T^4 we may twist it by the flat $U(1)$ connections, forming the family of Dirac operators

$$\mathcal{D}_{\tilde{t}} = \gamma^\mu (\partial_\mu + A_\mu + 2\pi i \tilde{t}_\mu) \quad (4.48)$$

parametrized by points $\tilde{t} \in \tilde{T}^4$. The twisted connection is still self-dual, and $\mathcal{D}_{\tilde{t}}$ may be seen as a supercharge of a $\mathcal{N} = 4$ SQM system to which tt^* geometry applies. Assuming all SUSY vacua have the same $(-1)^F$ grading, over the ‘coupling constant

space' \tilde{T}^4 we have a vacuum bundle, of rank K equal to the Witten index ($\equiv \text{ind } \mathcal{D}_{\tilde{t}}$) and whose Berry connection is hyperholomorphic, as we reviewed in the previous sections. This Berry connection is precisely the Nahm transform of A_μ .

From the SQM interpretation, it is clear that the Nahm transformed connection has singularities of a rather standard form: the singularities appear at the loci in coupling constant space \tilde{T}^4 where the energy gap vanishes and the SQM vacuum states mix with the continuum. tt^* is an IR description, and as all IR descriptions, should get in trouble at points where new light degrees of freedom appear.

All the above may be generalized to the higher dimensional case. We have a pair of dual even-dimensional Abelian varieties \mathcal{A} and \mathcal{A}^\vee each one parametrizing the flat $U(1)$ connections of the other one. \mathcal{A} , \mathcal{A}^\vee are flat hyperKähler manifolds. A hyperholomorphic connection on \mathcal{A} may be twisted by the flat Abelian family parametrized by \mathcal{A}^\vee , giving a family of $\mathcal{N} = 4$ SQM models whose tt^* geometry defines a hyperholomorphic connection on \mathcal{A}^\vee which is the Nahm transformed one. At the level of the correspondent coherent sheaves, it coincides with the Fourier–Mukai transform [34, 35].

4.9 Some examples from D-branes

As highlighted in this section, much of the tt^* structure only relies on an $\mathcal{N} = 4$ super quantum mechanics. Some structure, of course, hinges on having a $(2, 2)$ 2d theory: for example the spectral Lagrangian is tied to the twisted effective superpotential of the 2d theory in flat space. The notion of topological gauge for the tt^* connection is also closely related to the existence of a 2d cigar geometry which maps chiral operators to states on the circle. Still, the structure which remains in a 1d setup is rather interesting, especially if we consider the generalization to 1d-3d systems, *i.e.* to half-BPS line defects in 3d $\mathcal{N} = 4$ theories. Such defects preserve the same supersymmetry of an $\mathcal{N} = 4$ SQM and may have flavor symmetries or parameters which give rise to a tt^* geometry. This is essentially a dimensional reduction of the 2d-4d systems reviewed in a previous section.

The first obvious example is a massive 1d chiral field. There are three real mass parameters m_i and the 2d calculations make it clear that the tt^* geometry is a charge 1 $U(1)$ Dirac monopole in \mathbb{R}_m^3 . Notice that the Higgs field in the tt^* monopole geometry is essentially the moment map for the flavor symmetry. This is why it diverges at $\vec{m} = 0$, where the chiral field is massless.

In order to obtain a smooth $SU(2)$ monopole solution we can look at a SQM with $\mathbb{C}P^1$ target, study the dependence on the $SU(2)_m$ flavor mass parameters \vec{m} . The theory has two vacua which when the mass parameter is turned on roughly corresponding to the north and south pole of $\mathbb{C}P^1$. At large $|\vec{m}|$, the dynamics in the two vacua is well approximated by a single free chiral of charge ± 1 . The theory has no non-compact directions at any value of \vec{m} . Thus the tt^* geometry for \vec{m} is a smooth $SU(2)$ monopole with Abelian charge $(1, -1)$ at large \vec{m} , *i.e.* a single

smooth $SU(2)$ monopole. Notice that the asymptotic values of the Higgs field are given by the value of the moment map for (the Cartan sub algebra of) the $SU(2)$ flavor symmetry, which are $\pm t$, where t is the FI/Kähler parameter for the $\mathbb{C}P^1$ theory. Thus t controls the asymptotic values of the monopole geometry.

Conversely, the tt^* geometry for the FI/Kähler parameter t is given by a solution of $SU(2)$ Nahm equations on \mathbb{R}^+ , which are the Nahm transform of a pair of $U(1)$ Dirac monopoles of charge 1, at positions $\pm \frac{1}{2}\vec{m}$. At large t the two vacua again correspond roughly to the north and south poles of $\mathbb{C}P^1$. If we use a GLSM description, the two vacua require the three scalar fields in the gauge multiplet to be equal to $\pm \frac{1}{2}\vec{m}$. We expect to find a solution of Nahm equations with a Nahm pole at the origin of \mathbb{R}^+ , and constant diagonal vevs $(\frac{1}{2}\vec{m}, -\frac{1}{2}\vec{m})$ at infinity.

In order to generate more examples, we can look at the standard Hanany-Witten brane setup, with D3 branes stretched between NS5 branes, probed by a transverse D1 brane. Indeed, this setup gives 3d $\mathcal{N} = 4$ field theories probed by 1d line defects, which can be interpreted as coupling the 3d theories to some 1d GLSMs or as the 1d version of Gukov-Witten monodromy defects.

Depending on the choice of boundary conditions on the D1 brane, which may be realized concretely by having it end on a separate NS5 brane or D3 brane on a plane parallel to the system, one can get 1d defects with mass parameters corresponding to a motion parallel to the NS5 branes, or FI parameters corresponding to a motion along the D3 branes. For example, the 1d chiral can be engineered through a single semi-infinite D3 ending on a single NS5 brane, with a D1 brane with fixed position \vec{m} along the NS5 brane transverse directions. The t geometry for the 1d $\mathbb{C}P^1$ model can be engineered by two semi-infinite D3 branes ending on a single NS5 brane, with a D1 of fixed position t along the D3 branes. Then \vec{m} is the separation between the D3 branes.

In order to engineer the \vec{m} tt^* monopole geometry directly, we could look at a single D3 brane stretched between two NS5 branes, with a D1 probe of fixed position \vec{m} along the NS5 brane transverse directions. Then t is the separation between the NS5 branes. This setup realizes the smooth $SU(2)$ monopole geometry, but not through a $\mathbb{C}P^1$ 1d model. Instead, the physical interpretation of the brane system seems to be that of a single 1d chiral coupled to a 3d $U(1)$ gauge field. It would be interesting to study this simple field theory model further: the prediction that such model should have two vacua, corresponding to the D1 ending on either NS5 brane, is reminiscent to a somewhat mysterious phenomenon which occur for certain surface defects [14].

In general, the tt^* geometry for the brane systems is recovered by S-duality: the D1 brane becomes an F1 string, whose endpoint explores the supersymmetric gauge fields on a system of intersecting D3 and D5 branes: the gauge fields on the D3 branes give the solutions of Nahm equations, the gauge fields on the D5 branes give the BPS monopole solutions.

The world volume theory of the D1 brane could be interpreted as the 2d (4, 4) theory coupled to the 1d system as in section 4.5, with the choice of boundary conditions on the other end deciding which Nahm dual description emerges at the end.

The brane construction reviewed in this section has obvious generalizations which are commonly used to describe higher-dimensional theories and defects:

- A D2 probe of a D4-NS5 system engineers 2d theories or 2d-4d systems. The boundary conditions on the other end of the D2 probe correspond to gauging/ungauging a 2d flavor symmetry. The D2 probe theory is exactly the 3d free YM theory discussed in section 4.5. Lift to M-theory gives the spectral data of the system.
- A D3 probe of a D5-NS5 system (or a more general (p, q) fivebrane web) engineers 3d theories or 3d-5d systems. The D3 probe theory is exactly the 4d free YM theory discussed in section 4.5. T-duality together with a lift to M-theory produces the spectral data of the system. We will discuss this in detail in section 6.3.
- A D4 probe of a D6-NS5 system (the Hanany-Zaffaroni setup [80]) engineers 4d theories or 4d-6d systems. The D4 probe theory is exactly the 5d free YM theory discussed in section 4.5. Double T-duality together with a lift to M-theory produces the spectral data of the system. Single T-duality gives a periodic (p, q) fivebrane web. We will discuss this in detail in section 8.

5 tt^* geometry in 3 dimensions

In this section we would like to characterize the geometry of vacuum bundles in theories in 3 dimensions, with $\mathcal{N} = 2$ supersymmetry. More precisely we are interested in studying the vacuum geometry when the space is taken to be a flat T^2 with periodic boundary conditions for fermions, so as to preserve all supersymmetries. Our strategy will be as follows. We first clarify the structure of the parameter space taking into account that the space is T^2 . We then view the 3d theory as a special case of 2d $\mathcal{N} = (2, 2)$ theories with infinitely many fields, and use this relation to find the tt^* geometry in 3 dimensions. We shall see that they correspond to generalized monopole equations. We then show how this data can be used to compute the partition function of the theory on infinitely elongated S^3 and $S^2 \times S^1$ composed of two semi-infinite cigars joined in two different ways.

5.1 The parameter space

Consider a 3d theory with a global $U(1)$ symmetry. Furthermore we consider the space to be a flat T^2 . In such a case we can associate a three parameter deformations

of the theory (x, y, z) where $z \in \mathbb{R}$ denotes the twisted mass associated to the $U(1)$ symmetry and $(x, y) \in T^2$ denote the fugacities for the $U(1)$ symmetries around the cycles of the T^2 . Another way of saying this is to imagine weakly gauging this $U(1)$ symmetry. In the $\mathcal{N} = 2$ $U(1)$ vector multiplet we have a $U(1)$ gauge field A' and a scalar ϕ . Then

$$\langle \phi \rangle = z$$

$$\int_{S_a^1} A' = x, \quad \int_{S_b^1} A' = y,$$

where $S_{a,b}^1$ denote a basis for the two 1-cycles of T^2 . In the limit we turn off the gauge coupling constant, we can view (x, y, z) as parameters in the deformation space of the theory (see Fig. 8).

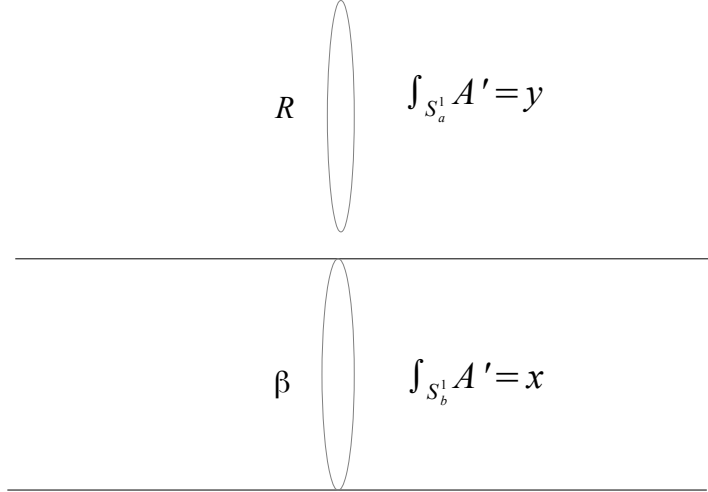

Figure 8: In the 2+1 dimensional theory we take the space to be T^2 comprised of two circles (S_a^1, S_b^1) of lengths (R, β) where we turn twisted by flavor symmetry by y, x respectively (by turning on background field A' coupling to the flavor current).

If we have a rank r flavor symmetry, the same argument, *i.e.*, weak gauging and giving vev to the adjoint ϕ in the Cartan subalgebra of the flavor group and to Wilson lines in the Cartan torus, shows that we have a parameter space

$$(T^2 \times \mathbb{R})^r.$$

Taking into account the full symmetry of the problem amounts to dividing the above space by the action of the Weyl group of the flavor symmetry.

Note that in presence of a $U(1)$ gauge symmetry we have, associated with it, a global $U(1)$ symmetry (related to monopole number) where the $U(1)$ current is $J = *F$. The twisted mass in this case corresponds to FI-term for the $U(1)$ gauge

symmetry, while the coupling constant corresponds to coupling the $U(1)$ gauge field A to a background $U(1)$ gauge field A' with a Chern-Simons interaction

$$\int A' \wedge F$$

and the vevs of A' along the two S^1 's give the (x, y) parameters. The FI parameter plays the role of m . At any rate, applying the logic of the previous discussion (as a special case) to a theory which includes a gauge symmetry $U(1)^r$ will lead again to a parameter space $(T^2 \times \mathbb{R})^r$.

5.2 Derivation of 3d tt^* geometry from 2d perspective

In this section we show how to derive the equations for tt^* geometry for 3d by viewing it from the 2d perspective. What we will show is that from the 2d perspective for each $U(1)$ symmetry the fundamental group of the parameter space receives an extra \mathbb{Z} , since the 2d superpotential restricted to that sector will pick up an extra term nt where $n \in \mathbb{Z}$ and t is a 2d coupling associated to $U(1)$. Once we show this, the structure of the 3d tt^* falls in the class discussed in sections 3 where we obtained the generalized monopole equations.

The argument for this is as follows: Suppose we have a $U(1)$ global symmetry in 3d. Consider compactifying the theory from 3d to 2d on S_a^1 with fugacity y around the circle for the $U(1)$. Then we obtain a $\mathcal{N} = (2, 2)$ theory in 2 dimensions, which includes a chiral deformation parameter given by

$$t = z + iy.$$

Note that t takes values on a cylinder because y is periodic. On a space \mathbb{R} , this 2d theory will in addition have sectors \mathcal{H}_n corresponding to $U(1)$ charge n . The supersymmetry algebra has a central term in this sector given by nt . To see this, note that for a theory in 3 dimensions, if we take the space to be $\mathbb{R} \times \mathbb{R}$ and consider a sector with flavor $U(1)$ charge n , the fact that we have turned on the twisted mass parameter would have implied the central charge to be nz . Upon compactification of \mathbb{R} to a circle S_a^1 turning on fugacity y , given the holomorphic dependence of W on t , the central charge in the supersymmetry algebra, which is the value of the superpotential in this sector, must be completed to nt , as was to be shown. Therefore we are in the category of 2d theories where the vacua have a shift symmetry along which W changes by an integer times a complex parameter and, as we have already discussed, this leads to generalized monopole equations for the tt^* geometry. Note, in particular, that turning on the fugacity x around the second circle S_b^1 corresponds to weighing the n vacua by

$$|\alpha, n\rangle \rightarrow \exp(2\pi i x n) |\alpha, n\rangle.$$

In other words

$$|\alpha, x\rangle = \sum_n \exp(2\pi i n x) |\alpha, n\rangle,$$

which is consistent with the definition of x -vacua discussed in section 3. We therefore see that the tt^* geometry for 3d $\mathcal{N} = 2$ theories corresponds to generalized monopole equations.

5.3 Chiral algebra and line operators

Consider the 3d theory compactified on S_a^1 , on a circle of size R_a . This leads to an $\mathcal{N} = (2, 2)$ theory in 2d. Let us take a generic case where we will have n vacua with mass gap where n is the Witten index of the theory. From the 2d perspective we expect to have a chiral algebra with n elements. These chiral fields should correspond to line operators from the 3d perspective wrapped around S_a^1 . Clearly they are localized over a point in 2d, so they could be in principle either point operators in 3d or line operators. The fact that their coupling involves $\int d^2\theta t^i \Phi_i$, and the imaginary part of t is a global parameter y having to do with the holonomy around the S_a^1 , shows that the operator must be a loop operator wrapping S_a^1 and coupled to this global holonomy (see Fig. 9). Note that the algebra they form will depend on the radius R_a .

In the case of supersymmetric gauge theories, these line operators correspond to supersymmetric Wilson lines. See a nice discussion of them in [43]. In particular in the case of pure $N = 2$ Chern-Simons gauge theory, where the theory is equivalent to a topological theory, this algebra is isomorphic to the Verlinde algebra. We will return to this discussion after considering the partition functions of these theories on spheres which we now turn to.

5.4 Geometry of T^2 and partition functions on elongated $S^2 \times S^1$ and S^3

In this section we discuss the global interpretation of the partition functions computable using tt^* geometry in 3d. The geometry of the space is captured by the two-torus $S_a^1 \times S_b^1$. For most of the discussion we would be interested in a rectangular torus. In particular if τ is the complex structure parameter for the torus, we take $\tau_1 = 0, \tau_2 = R_a/R_b$, in other words $\tau = iR_a/R_b$. The reason for the choice of rectangular torus is that if we set the $\tau_1 \neq 0$ we would not have a reduction to a Lorentz-invariant 2d theory. One can in principle also study this extension (which will induce some non-commutativity structure from the 2d perspective if we are discussing any amplitude other than vacuum amplitudes), but for simplicity we limit our discussion mainly to the rectangular case. In addition to τ the geometry of the torus is characterized by its area $A = R_a R_b$. Clearly there is an isomorphism of the theory which takes

$$(\tau, A) \rightarrow (-1/\tau, A),$$

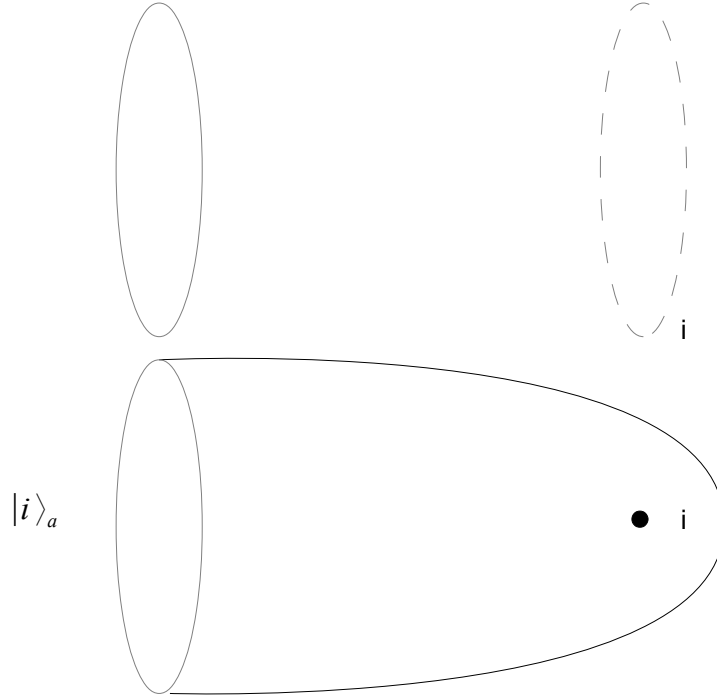

Figure 9: Vacuum states in the 3d theory $|i\rangle_a$ can be obtained by doing a path-integral on an infinitely long solid torus, which is equivalent to an infinitely long cigar times a circle. The chiral fields in 2d are obtained by wrapping the line operator along the circle S_a^1 , *i.e.* the circle in the solid torus which is not contracted.

by simply switching the role of the two circles.

There are two inequivalent ways we can view this theory as a 2d theory, depending on whether we take S_a^1 or S_b^1 as part of the spatial direction of the 2d theory. Of course, the geometry of the vacuum bundle does not depend on this choice. However, the tt^* has more information than just the vacuum geometry: It has also a choice of preferred sections for the vacuum bundle given by semi-infinite cigar cappings of the theory. Let us take S_b^1 as part of the 2d spatial directions which are taken to form a semi-infinite cigar inside which the cycle S_b^1 shrinks. Then the preferred choice of the vacuum bundles are labeled by chiral operators on the cigar:

$$|i\rangle_a$$

as discussed before for the general case in 2d (see Fig. 9). The label a in the above state is to remind us that this is the circle we have chosen not to shrink. Moreover this corresponds to the fact that the line operators are wrapping the a -cycle S_a^1 .

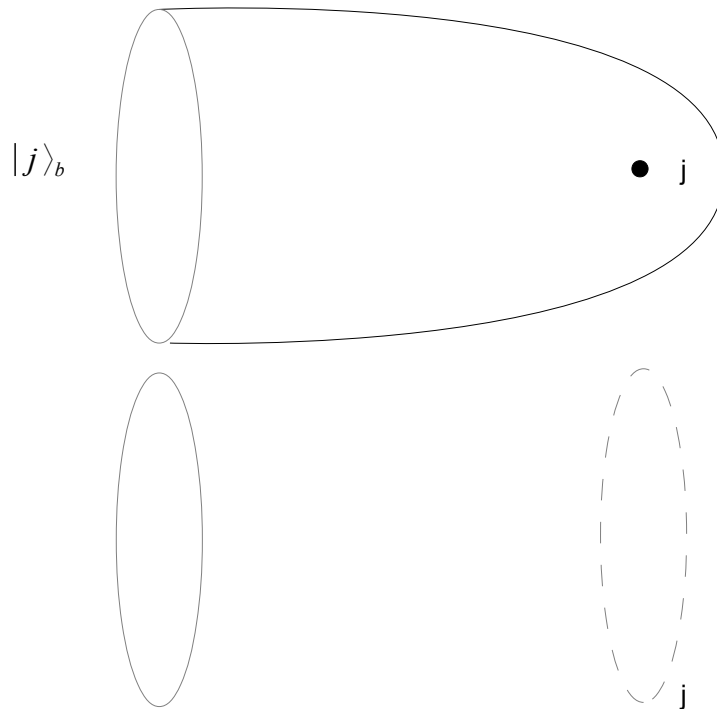

Figure 10: The 3d vacuum states can be obtained by filling either of the two circles, leading to two different bases for the vacua. In this figure $|j\rangle_b$ denotes the state obtained by inserting a line operator wrapped around the b-cycle.

Similarly, we can consider the 2d theory obtained by viewing S_a^1 as part of the 2d spatial dimensions and obtain the states (see Fig. 10):

$$|j\rangle_b.$$

If we change $\tau \rightarrow -1/\tau$ we come back to the same theory. In other words $|i(\tau)\rangle_a$ should be a linear combination of $|j(-1/\tau)\rangle_b$:

$$|i(\tau)\rangle_a = S_i^j(\tau)|j(-1/\tau)\rangle_b$$

More precisely we have, restoring the x, y -dependence

$$|i(\tau), t = z + iy, x\rangle_a = S_i^j(\tau) |j(-1/\tau), t' = z - ix, y\rangle_b.$$

S_i^j depends on all parameters, but here we are just exhibiting its dependence on τ . Note that S_i^j satisfies

$$S_i^j(\tau) S_j^k(-1/\tau) = \delta_i^k,$$

because this operation corresponds to π rotation in 3d (and in particular takes $(x, y) \rightarrow (-x, -y)$), and this acts trivially on the vacua (as can be seen by taking the large area limit of a square torus and noting that this reflection can be generated by continuous rotations for which the vacua are neutral). We can also consider the D-brane boundary conditions, which are in 1-1 correspondence with the number of vacua (in a massive phase). Let D_c denote one of the boundary states. We then have

$$\Pi_i^{c(bb)} = {}_b\langle D_c | i \rangle_b.$$

Note that from the 3d perspective $\Pi_i^{c(bb)}$ is given by a path-integral in a space with the topology of a solid torus, whose boundary is a T^2 given by the D-brane state D_c . It is useful to rewrite the boundary states $|D_a(-1/\tau)\rangle_b$ in terms of $|D_c(\tau)\rangle_a$. First we have to recall that D_c depends on ζ which determines which combination of supercharges it preserves. In going from τ to $-1/\tau$ the values of ζ also changes, as discussed in eq.(3.26): $\tilde{\zeta} = \mathbf{C}(\zeta) \equiv \frac{1+i\zeta}{\zeta+i}$. Since the theories are the same, the boundary state should be a linear combination of one another. In fact as we have already noted these boundary states satisfy are sections of the Lax connection and therefore there must exist a constant matrix E_c^d such that

$$|D_c^\zeta(\tau), t = z + iy, x\rangle_a = E_c^d |D_d^{\tilde{\zeta}}(-1/\tau), t = z - ix, y\rangle_b \quad (5.1)$$

Note that repeating this operation is equivalent to a Z_2 spatial reflection. This implies that $E^4 = 1$ (using the fact that the ground states all have even fermion number). Indeed with a suitable choice of basis (adapted from the point basis in the IR) it can be taken to be a diagonal matrix. For simplicity of notation we will not explicitly write the corresponding phases. Also, we will not explicitly write the ζ in the definition of states. Sometimes we choose one of the two preferred values $\zeta = \pm 1$ which are the fixed points of the transformation $\zeta \mapsto \mathbf{C}(\zeta)$. We will return to the significance of this choice later.

We can then compute, as in the general 2d case, the 2d topological metric η and Hermitian metric g :

$$\eta_{ij}^{(aa)} = {}_a\langle j | i \rangle_a \quad g_{i\bar{j}}^{(aa)} = {}_a\langle \bar{j} | i \rangle_a.$$

The topology of the space for both of these computations correspond to $S^2 \times S_a^1$, where S^2 is a sphere with an infinitely elongated cylindrical neck. The computation of η , which is a topological invariant, can also be done for a finite size sphere. For

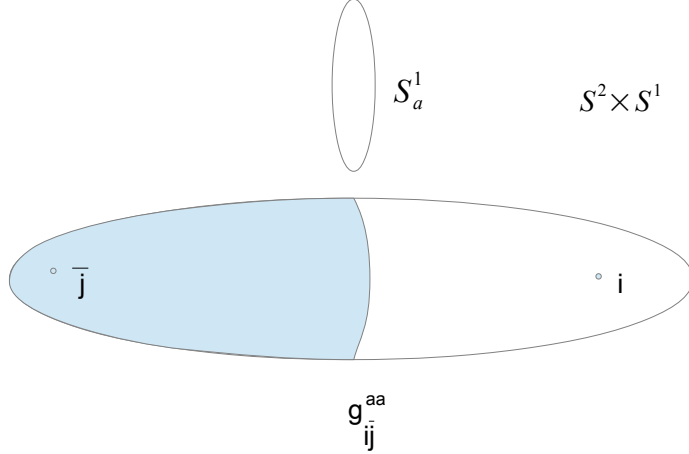

Figure 11: The inner product on the Hilbert space restricted to the vacuum states can be represented by the path-integral on $S^2 \times S^1$ with infinitely elongated S^2 , where the chiral and anti-chiral line operators are inserted at the two ends.

the computation of the Hermitian metric the infinite size sphere is crucial. We can also consider the partition function on $S^2 \times S_b^1$ where the role of a, b are exchanged. Just as in the general 2d case, eqn.(2.6), we have (see *e.g.* Fig. 11 for the metric g)

$$\eta_{ij}^{(aa)} = \hat{\Pi}_j^{c(aa)} \Pi_i^{c(aa)}$$

$$g_{i\bar{j}}^{(aa)} = \hat{\Pi}_j^{c(aa)\dagger} \Pi_i^{c(aa)}.$$

We can also consider capping different circles on the two sides, producing the 3d topology of S^3 . Notice that now there is no purely topological version, because S^3 does not admit an $SO(2)$ holonomy metric, and thus the amplitude only makes sense when we consider a S^3 with an infinitely long flat neck. Moreover, whether we choose the topological or the anti-topological theory on either side, the computation is hard. Let us then consider the inner product of the vacua thus obtained. We define

$$S_{ji}(\tau) = {}_a \langle j(\tau) | i(-1/\tau) \rangle_b = S_j^k(\tau) {}_b \langle k(-1/\tau) | i(-1/\tau) \rangle_b = S_j^k(\tau) \eta_{ki}^{(bb)}.$$

The expressions of $S_{\bar{i}j}$ and $S_{i\bar{j}}$ can be obtained from S_{ij} using the reality matrix $M_{\bar{i}}^k$ discussed in the 2d context, so we will restrict our attention to S_{ij} . Note that S_{ij} can be viewed, from the 3d perspective, as the result of gluing two solid tori, each with infinitely long necks, one of which has line operator i inserted along its center corresponding to the a -cycle, and the other one with the line operator j inserted along the b -cycle. In other words, topologically the two line operators are

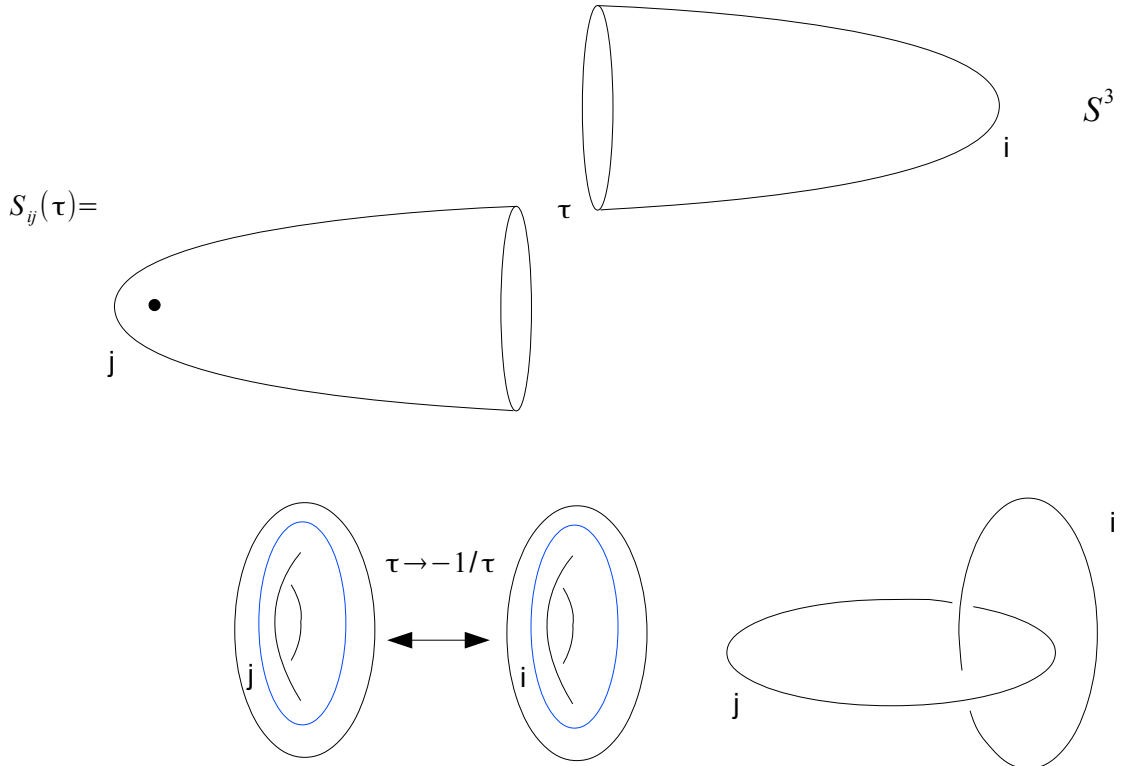

Figure 12: The S_{ij} can be viewed as the partition function on S^3 with line operators inserted at the two ends. This can be viewed as the Heegard decomposition of the S^3 : the gluing two solid tori each with a line operator inserted and whose boundaries are identified by the $\tau \rightarrow -1/\tau$ transformation, exchanging the two cycles of T^2 .

Hopf linked. This is familiar from the structure of Chern-Simons theory [44]. Of course this is not accidental: In the case of $\mathcal{N} = 2$ Chern-Simons theory with no matter, the theory is equivalent to $\mathcal{N} = 0$ Chern-Simons theory, for which the line operators are the Wilson loop observables. In that context S_{ij} is the Hopf link invariant associated to loops indexed by the representations i and j . This in turn is the modular transformation matrix of the conformal blocks of the associated 2d RCFT. Unlike the topological case, where S_{ij} does not depend on any parameters, in the more general case we are considering S_{ij} does depend on parameters of the theory and in particular on τ (see Fig. 12).

In order to compute S_{ij} we use the fact that we can compute $\Pi_i^{c(aa)}$ as discussed

before. Therefore it suffices to write S_{ij} in terms of them. We have

$$\Pi_i^{c(aa)}(\tau) = {}_a\langle D_c(\tau)|i\rangle_a = S_i^j(\tau) \langle D_c(-1/\tau)|j\rangle_b = S_i^j(\tau) \Pi_j^{c(aa)}(-1/\tau). \quad (5.2)$$

In other words, we have

$$S_i^j(\tau) = \Pi_i^{c(aa)}(\tau) [\Pi^{(aa)^{-1}}(-1/\tau)]^{cj}, \quad (5.3)$$

leading to

$$S_{ij} = \Pi_i^{c(aa)}(\tau) [\Pi^{(aa)^{-1}}(-1/\tau)]^{ck} \eta_{kj}^{(bb)}.$$

The vacuum amplitude is given by

$$S_{00} = \Pi_0^{c(aa)}(\tau) [\Pi^{(aa)^{-1}}(-1/\tau)]^{\hat{c}0} \quad (5.4)$$

where $\hat{0}$ denotes the spectral flow operator dual to the identity. Note that for the case of a single vacuum theory we get

$$S_{00} = \Pi^{(aa)}(\tau) \Pi^{(aa)^{-1}}(-1/\tau).$$

This expression is similar to the expression of the partition functions for supersymmetric amplitudes on ellipsoid S_b^3 for a theory of, say, free chiral theory, where instead of $\Pi^{(aa)}(\tau)$ one has the quantum dilog with $\tau = b^2$ where b is the squashing parameter. As we will discuss later, this is not accidental: In a partial UV limit (similar to the $\bar{\beta} \rightarrow 0$ limit in 2d) the $\Pi^{(aa)}$ reduces to quantum dilog. More generally we will argue in a later section that eqn.(5.4) is consistent with the results of [2] in their computation of the partition functions on S_b^3 in terms of sums over chiral blocks, which in the formula above is the sum over c .

5.5 Partition functions as gauge transformations

There is a different (but equivalent) interpretation of the partition functions on infinitely elongated $S^2 \times S^1$ and S^3 which is more convenient in actual computations.

Let us consider first elongated $S^2 \times S_a^1$. The elongated partition function is just the component of the tt^* metric

$$g_{00}^{(aa)}.$$

There are two natural trivializations of the vacuum bundle over $S_a^1 \times S_b^1$ namely the ones given, respectively, by the topological and the anti-topological twisting on a cigar which caps the circle S_b^1 . The vacuum bundle Berry connections in these two natural trivializations read

$$\begin{cases} D = \partial + g\partial g^{-1} \\ \bar{D} = \bar{\partial} \end{cases} \quad \text{and respectively} \quad \begin{cases} D = \partial \\ \bar{D} = \bar{\partial} + g^{-1}\bar{\partial}g \end{cases} \quad (5.5)$$

where $g = g^{(aa)}$ is the tt^* metric. We see that the tt^* metric $g^{(aa)}$ is nothing else than the complexified gauge transformation mapping the Berry connection in the topological gauge to the one in the anti-topological gauge.

The same kind of identification holds for the quantity S_i^j defined in eqn.(5.3), and hence for the elongated S^3 partition function. Again we have two preferred trivialization of the same vacuum bundle given by the states $|i, \tau\rangle_a$ and $|j, -1/\tau\rangle_b$. In the first trivialization the Berry connection A has the form in the left part of eqn.(5.5) with $g = g^{(aa)}$, while in the second one it is given by $\mathbf{S}A$, where \mathbf{S} is the $\pi/2$ rotation acting as

$$\mathbf{S}: x \rightarrow y, y \rightarrow -x, \tau \rightarrow -1/\tau,$$

that is,

$$\begin{aligned} \mathbf{S}A_y(x, y, z, \beta, R) &= A_x(y, -x, z, R, \beta), \\ \mathbf{S}A_x(x, y, z, \beta, R) &= -A_y(y, -x, z, R, \beta), \\ \mathbf{S}A_z(x, y, z, \beta, R) &= A_z(y, -x, z, R, \beta). \end{aligned}$$

Since the connections A and $\mathbf{S}A$ describe the same physical monopole in x, y, z space, they are gauge equivalent, *i.e.* there is a complex gauge transformation S such that

$$\mathbf{S}A = S A S^{-1} + S dS^{-1}, \quad (5.6)$$

This matrix S clearly coincides with the matrix S_j^i defined in eqn.(5.3).

Another way to see this identification, is to consider the brane amplitude Π^c at $\zeta = \pm 1$. As discussed around eqn.(3.27), Π^c and $\mathbf{S}\Pi^c$ satisfy the same Lax equations $\nabla\Pi^c = \bar{\nabla}\Pi^c = 0$, and in fact both form a fundamental system of solutions of these linear equations. Then they are linear combinations of one another with constant coefficients. More precisely, since they are written in different gauges, we must have

$$\Pi_i^c = U_i^j \mathbf{S}\Pi_j^c \quad (5.7)$$

where U is the (complexified) gauge transformation relating these two gauges. Comparing with eqn.(5.2), we get

$$U_i^j = S_i^j, \quad (5.8)$$

which is our identification.

This identifications allows us to compute the partition function from the Berry connection without having to solve the Lax linear problem. In other words, we may read the partition function on the infinitely elongated S^3 directly from the tt^* monopole configuration in x, y, z space, without solving any additional partial differential equation.

The gauge viewpoint gives an alternative argument for the independence of the matrix E mapping D-branes at τ to $-1/\tau$, from all parameters, and how it can be

set to be the identity matrix. *A priori*, the Lax equations imply eqn.(5.7) in the weaker form

$$\Pi_i^a = S_i^j \mathbf{S} \Pi_j^b E_b^a,$$

where E is a non-degenerate constant numerical matrix. In a theory with a mass-gap, rescaling the masses to infinity both connections A and $\mathbf{S}A$ go to zero, hence $S \rightarrow 1$, while, using the point basis for the line operators and the corresponding thimble basis for branes, both Π and $\mathbf{S}\Pi$ approach the identity matrix. Then we remain with a diagonal E matrix, which as discussed before satisfies

$$E^4 = \mathbf{1} \quad \text{diagonal in point/thimble basis, } \zeta = \pm 1. \quad (5.9)$$

5.6 Massive limits and topological line operator algebra

Consider 3d, $\mathcal{N} = 2$ theories, which have a mass gap. Such theories in the IR flow to trivial theories with no non-trivial local correlation functions. However, this does not mean the theory is trivial: It could still hold interesting topological non-local observables. The simplest examples of this kind are $\mathcal{N} = 2$ pure Chern-Simons theories with no matter. In such cases the theory in the IR is locally trivial and the only non-trivial observables are the line operators associated with Wilson loops. Supersymmetric Wilson loops are rigid in shape, but since this theory is equivalent to $\mathcal{N} = 0$ Chern-Simons theory, we can dispense with the condition of preserving supersymmetry and consider general Wilson loops, and use the topological invariance of the theory to solve it, as was done by Witten [44].

We would like to study this same phenomenon in the general case, and consider in addition the process of flow to the IR as well. In fact, if we consider the Hilbert space of such a theory quantized in T^2 , the flow to the IR corresponds to changing the area of T^2 , while preserving its shape, given by the complex modulus τ . In other words, we would be studying the flow

$$(\tau, A) \rightarrow (\tau, e^t A).$$

It is natural to conjecture that, for all such theories with mass gap, we always end up with a purely topological theory in the IR, for which the line operators we have been studying play the role of non-trivial observables. In particular it is natural to conjecture that in this limit S_{ij} will become independent of τ and satisfies the usual properties familiar from the Verlinde algebra theory. Moreover we conjecture that, as in the case of the Verlinde algebra [48], the chiral ring becomes, in a suitable basis, an integral algebra whose multiplication table is given by positive integers

$$C_{jk}^i = N_{jk}^i \in \mathbb{Z}^+,$$

and that S_{ij} diagonalizes the algebra which is equivalent to the statement that

$$\lambda_i^l = \frac{S_{il}}{S_{0l}}$$

satisfy the ring algebra

$$\lambda_i^l \lambda_j^l = N_{ij}^k \lambda_k^l,$$

where there is no sum in l in the above formula, but there is a sum in k in the RHS.

Let us try to see to what extent we can recover these structures in our context. Consider the $\mathcal{N} = 2$ theory on T^2 , and consider the set of line operators Φ_i . More specifically, we will consider these line operators wrapped around the a or the b cycle of T^2 and denote the corresponding operators by $\Phi_i^{(a)}$, $\Phi_i^{(b)}$. These two sets of operators act on the ground states. In general they have different spectrum, because the radii are not equal. Moreover the (x, y) are not zero. Let us therefore restrict attention to the case $R_1 = R_2 = R$, *i.e.*, $\tau = i$, and $A = R^2$. Furthermore let us take $x = y = 0$. For this particular case the spectrum of the two sets of operators is the same, because spatial rotation by $\pi/2$ is a symmetry of this square torus, and represented by a unitary operator. Let us denote this operator by U . Note that on the ground states:

$$U|i\rangle_a = |i\rangle_b$$

which implies that

$$S_{ij} = {}_a\langle i|j\rangle_b = {}_a\langle i|U|j\rangle_a$$

In other words the matrix elements of U can be identified with the matrix S . We will thus denote U by S from now on.

From the fact that U acts on line operators taking the line operators around the a -cycle to that on the b -cycle, we learn

$$S\Phi_i^{(a)}S^{-1} = \Phi_i^{(b)}.$$

Thus finding the S matrix, for $\tau = i$ amounts to finding the change of basis involved in going from the basis of vacua for the a -cycle to that for the b -cycle. In particular, if we know how $\Phi_i^{(b)}$ acts on the $|j\rangle_a$ we can compute the S -matrix (since the action of $\Phi_i^{(a)}$ on $|j\rangle_a$ is known to be given by $C_{ij}^k|j\rangle_a$).

For the case where we are dealing with $U(1)$ gauge theories, the $\Phi_i^{(b)}$ corresponding to the line operator in the fundamental representation can be identified as the supersymmetric version of

$$\exp\left(i \int_b A\right).$$

The insertion of this operator in the cigar geometry C , for the topologically twisted theory, is equivalent to the insertion of the supersymmetrization of $\exp(i \int_C F)$. This operator corresponds to changing the θ -angle of the 2d theory by

$$\theta \rightarrow \theta + 2\pi.$$

In other words

$$\Phi^{(b)} \longleftrightarrow O_{\Delta\theta=2\pi}$$

where $O_{\Delta\theta=2\pi}$ is the operator changing the vacua by shifting θ by 2π . In other words, it is the holonomy of the tt^* connection acting on the vacua as we go around one of the cycles of T^2 in the parameter space. We do know the eigenvalues of the $O_{\Delta\theta=2\pi}$, but that turns out not to be enough to fix the action of it on the vacua. In particular, in principle this is a complicated operator, which depends on solving the tt^* -geometry. However, it turns out that in the $A \rightarrow \infty$ limit, *i.e.* in the IR limit, it is easy to fix this operator: In this limit the classical vacua corresponding to point vacua do not mix with each other, and so in the point basis, the action of $\theta \rightarrow \theta + 2\pi$ is easy to find, as we will see in the example section. In particular we will find that in the IR limit we get the explicit form of S . In this way it is easy to check if the S diagonalizes the ring algebra, and we shall see that this is indeed the case in the examples we will consider.

Before going to that, we make some preliminary comment on the 3d brane amplitudes in general.

5.7 Generalities of 3d brane amplitudes

We have already discussed the structure of the D-brane amplitudes in the 2d context and their singularity structure as a function of the spectral parameter ζ . We can now describe how this structure changes in the 3d context. The standard essential singularity at $\zeta = 0, \infty$ is intimately connected to the presence of a compact direction in the 2d tt^* . If one were to look at a “1d” version of the tt^* geometry, *i.e.* say at solutions of Nahm equations or non-periodic monopoles, flat sections of the Lax connections would extend smoothly over the whole twistor sphere parameterized by ζ .

Conversely, suppose we want to study the 3d tt^* geometry with a standard, BPS, Lorentz-invariant 3d boundary condition B_{3d} and analyze the amplitude $\Pi[B_{3d}]$ in the usual 2d language. What is the 2d phase ζ associated to this problem? The 3d supercharges can be collected into complex 3d spinors of specific R-charge ± 1 , which we denote as Q_α^\pm . A BPS boundary condition preserves a chiral half of the 3d supercharges, of specific eigenvalue for the 3d gamma-matrix σ^1 in the direction orthogonal to the boundary. This corresponds to a specific value of ζ . This is in agreement with the analysis in section 3. Indeed, consider a brane wrapped on a square torus T^2 : under a $\pi/2$ rotation of T^2 a Lorentz-invariant brane amplitude should go to a brane amplitude of the same kind, and this is possible only if ζ is a fixed point of the Cayley transform $\zeta \mapsto \mathbb{C}(\zeta)$ in eqn.(3.26). In the conventions of section 3, where the periodic parameters x_a, y_a are the imaginary parts of the holomorphic coordinates in the $\zeta = \infty$ complex structure, *cfr.* eqn.(3.18), the two fixed points are $\zeta = \pm 1$. Equivalently, the specific values of ζ corresponding to Lorentz-invariant branes may be obtained by requiring that the Stokes discontinuities, eqn.(3.54),

which are holomorphic functions of

$$x - i \frac{\zeta + \zeta^{-1}}{2} y$$

behaves correctly under $\pi/2$ rotations and hence are functions of $x + iy$ (resp. $x - iy$). This restriction on the values of ζ is also consistent with the analysis of the partition function on an infinitely elongated S^3 in the previous subsections which was based on $\zeta = \pm 1$ brane amplitudes. The special properties of the $\zeta = \pm 1$ amplitudes will be checked in an explicit example in §.6.1.3 below.

Upon compactification of the theory on a circle, it is probably possible to deform a Lorentz-invariant 3d boundary condition to a non-Lorentz invariant version which preserves a more general combination of the supercharges, and gives a flat connection for the spectral connection at general ζ . This we expect, based on the fact that once we decompose the 3d theory, in terms of 2d data, such a generic parameter ζ emerges as a possibility in defining the brane amplitude. As we may look at the 3d geometry as a 2d geometry in infinitely many ways, depending on which cycle of the torus we take as “internal” and which one as 2d Euclidean time, we expect the essential singularities we encountered in 2d to appear at infinitely many locations. If we identify $\zeta = \pm 1$ as the poles of the sphere, the essential singularities should appear at the equator, that is, for ζ on the imaginary axis (which, as already noted, is a fixed line for the Cayley transform (3.26)).

On the other hand, from the point of view of the 2d theory which arises from compactification on a circle, the compactification of the 3d theory on a cigar geometry also appears as a “brane”, which preserves the supersymmetry corresponding to $\zeta = i$. There is actually a family of such “branes” which arise from a cigar with a line defect at the tip. Clearly, the amplitudes for such “branes” are closely related to the S matrix defined above. We will illustrate this fact in simple examples.

5.8 Comparison with susy partition functions on $S^2 \times S^1$ and S_b^3

Supersymmetric partition functions on $S^2 \times S^1$ and S_b^3 have been computed recently [2, 49, 50] in a variety of contexts. Given that we have also been computing supersymmetric partition functions on the same topologies it is natural to ask the comparison between the two.

The first point to notice is that they do not look to be the same: The partition function computed using tt^* becomes supersymmetric *only in the limit* of infinitely elongated geometries. This is not so for the supersymmetric partition functions on S_b^3 or $S^2 \times S^1$ where for finite metric the path-integral is supersymmetric.

Indeed a similar question arises for 2d theories recently studied in [51]. In that context it was found that at the conformal limit the tt^* partition function for elongated S^2 [52, 53], *i.e.*, the amplitude $g_{0\bar{0}} = \langle 0|\bar{0}\rangle$, coincides with the supersymmetric partition function on S^2 . However, it was also found that away from the conformal

point the partition function on S^2 does not agree with the tt^* partition function. In that case, as we will argue, there is a limit of the tt^* partition function which reproduces the simpler supersymmetric partition function on S^2 . The same result works in the 3d case as well leading to the statement that an asymmetric limit of the tt^* partition functions lead to the supersymmetric partition functions.

Let us first discuss the case of 2d. As discussed in section 2 eqn.(2.6) the tt^* partition function on S^2 , i.e. $g_{0\bar{0}}$, is given by

$$Z_{S^2}^{tt^*} = \Pi_a(t_i, \bar{t}_i) \Pi^{a*}(t_i, \bar{t}_i).$$

However the supersymmetric partition function on S^2 is made of blocks which are holomorphic Π 's times anti-holomorphic Π 's. This structure is true for $S_{tt^*}^2$ only at the conformal point. Aways from it, the answer is far more complicated. However, we can consider the asymmetric limit where we take the UV limit, corresponding to $\bar{\beta} \rightarrow 0$, with fixed β . In this limit

$$\lim_{\bar{\beta} \rightarrow 0} \Pi_a(t_i, \bar{t}_i) = \tilde{\Pi}_a(t_i).$$

Moreover, as already discussed in section 2, in this limit Π_a are given by period integral with non-homogeneous W (satisfying simple differential equations). In this limit the partition function of the tt^* agrees with the supersymmetric partition function on S^2 :

$$Z_{S^2} = \tilde{\Pi}_a(t_i) \tilde{\Pi}^{a*}(\bar{t}_i)$$

Given this, it is natural to expect the same to work in the case of 3d. Indeed, as has been found in [2], the partition function of supersymmetric theories in 3d decomposes into blocks, exactly as in eqn.(5.4)¹⁹.

Indeed, as noted in [2], the chiral blocks are solutions to the difference equations arising from the ring relations satisfied by the line operators. This is also the case for us, in the $\bar{\beta} \rightarrow 0$, as follows from eqn.(2.10). Therefore in the same limit as in the 2d case the 3d tt^* geometry should reduce to the supersymmetric partition functions on S_b^3 and $S^2 \times S^1$. We will verify this expectation for the partition function of free chiral theory in section 6.

6 Examples of tt^* geometry in 3 dimensions

The 3d tt^* geometries should correspond to doubly-periodic solutions of the monopole equations, or their higher-dimensional generalizations. In this section we illustrate the correspondence in a number of examples.

¹⁹ The appearance of inverse power in the S^3 partition function and its absence in [2] has to do with the choice of analytic continuations used there versus what we have here. In our case $|q| < 1$ whereas the two blocks used in [2] used $|q| < 1$ for one block and $|q| > 1$ for the other block.

6.1 Free 3d chiral multiplet

The simplest example, of course, is a free 3d chiral multiplet of real twisted mass m , whose tt^* geometry should give a $U(1)$ monopole solution on the space parameterized by m and the flavor Wilson lines on the two cycles of T^2 . If one of the two circles in the compact geometry is very small, we expect to recover the results for the 2d chiral field. This identifies the monopole solution as a doubly-periodic Dirac monopole of charge 1. Indeed, the 3d free chiral field compactified on a circle of length R_y (which in the previous section we had simply called R) may be expanded in KK modes having 2d complex masses

$$\mathbf{m}_n = m + \frac{2\pi i}{R_y}(n + y) \quad n \in \mathbb{Z}, \quad (6.1)$$

where y is the flavor Wilson like along the circle, which is a periodic variable of period 1. The 2d mirror is then described by the (twisted) superpotential of the form [12]

$$W(Y_n) = \sum_{n \in \mathbb{Z}} \left(\frac{1}{2} \left(\frac{m}{2\pi} + i \frac{n + y}{R_y} \right) Y_n - e^{Y_n} \right). \quad (6.2)$$

Since the modes Y_n are decoupled from each other, the tt^* metric is simply the product of the metrics for each mode which, as described in §.3.1, correspond to periodic monopole solutions. The doubly-periodic monopole solution associated to the 3d free chiral is then the superposition of an infinite array of periodic Abelian monopole solutions, each corresponding to the contribution from a 2d KK mode. Thus the harmonic function giving the Higgs field in the monopole solution is

$$V_{\text{chiral}}(m, x, y) = -\pi \sum_{n,k} \left(\frac{1}{\sqrt{m^2 + \frac{4\pi^2}{R_x^2}(x+k)^2 + \frac{4\pi^2}{R_y^2}(y+n)^2}} - \kappa_{k,n} \right) + \Lambda \quad (6.3)$$

where $R_x \equiv \beta$ is the length of the tt^* circle, $\kappa_{k,n}$ some constant regulator, and Λ a constant (see appendix B.1 for full details). In a natural basis (which in the $R_y \rightarrow 0$ limit reduces to the standard 2d ‘point’ basis), the tt^* metric is simply

$$G_{\text{chiral}}(m, x, y) = \exp \left(\frac{2}{R_x} \int_0^x V_{\text{chiral}}(m, x', y) dx' \right). \quad (6.4)$$

As discussed in section 5, $G_{\text{chiral}}(m, x, y)$ may be interpreted as the partition function on the infinitely elongated $S^2 \times S^1$ geometry with flavor twist parameters x, y around the equator of S^2 and the S^1 , respectively

$$Z_{S^2 \times S^1} = G_{\text{chiral}}(m, x, y). \quad (6.5)$$

At large $|m|$, the harmonic function V_{chiral} has a linear growth:

$$V_{\text{chiral}} = \frac{R_x R_y}{2} |m| + O\left(\exp\left[-\min(R_x, R_y) |m|\right]\right). \quad (6.6)$$

This is slightly inconsistent: it corresponds to $\pm\frac{1}{2}$ units of flux for the gauge bundle on the x - y torus. This is closely related to the \mathbb{Z}_2 anomaly for a 3d free chiral: depending on the sign of the mass m , integrating away a 3d chiral leaves a background Chern-Simons coupling of $\pm\frac{1}{2}$ for the flavor $U(1)$ symmetry. In general, we expect the slope of the Higgs field at large values of the masses, or the units of flux on the flavor Wilson line tori, to coincide with the effective low energy background CS couplings for the corresponding flavor symmetries.

Notice that the spectral data computed from $D_x + iD_y$ and $-D_m + V$ involves a holomorphic connection on the torus, which is covariantly constant in the m direction. Thus the topological data of the holomorphic bundle, *i.e.* the Chern class on T^2 , is m -independent, and can only jump at the location of Dirac monopoles, by an amount equal to the Dirac monopole charge. This explains the slopes we find at large $|m|$.

A better defined choice (the ‘‘tetrahedron theory’’ in [45]) is a theory Δ of a 3d chiral together with an additional background CS level of $-\frac{1}{2}$. This corresponds to the harmonic function

$$V_{\Delta}(m, x, y) = -\frac{R_x R_y}{2} m - \pi \sum_{n,k} \left(\frac{1}{\sqrt{m^2 + \frac{4\pi^2}{R_x^2} (x+k)^2 + \frac{4\pi^2}{R_y^2} (y+n)^2}} - \kappa_{k,n} \right) + \Lambda \quad (6.7)$$

which has coefficients -1 or 0 for the linear growth at $m \rightarrow -\infty$ and $m \rightarrow \infty$ respectively, and corresponding effective CS couplings.

The harmonic function V_{Δ} has alternative representations which converge more rapidly than (6.7) and are convenient to study particular limits (see appendix B.1). For instance, we have the Fourier representation

$$V_{\Delta}(m, x, y) = -R_x R_y m \Theta(-m) - \frac{1}{2} \sum_{(k,\ell) \neq (0,0)} \frac{R_x R_y}{\sqrt{R_y^2 \ell^2 + R_x^2 k^2}} e^{2\pi i k x + 2\pi i \ell y - \sqrt{R_y^2 \ell^2 + R_x^2 k^2} |m|}. \quad (6.8)$$

If we treat the y direction as ‘‘internal’’ and the other two as the standard directions of 2d tt^* , we can assemble the monopole connection and Higgs field into

the usual tt^* quantities²⁰. Comparing with eqn.(3.30), we have

$$\begin{aligned} C_\mu &= R_x \left(\partial_x - iA_x \right) + V \\ -\bar{C}_{\bar{\mu}} &= R_x \left(\partial_x - iA_x \right) - V \\ D_\mu &= \partial_\mu - iA_\mu \\ D_{\bar{\mu}} &= \partial_{\bar{\mu}} - iA_{\bar{\mu}}, \end{aligned} \tag{6.9}$$

where

$$\mu = \frac{1}{4\pi} (m + 2\pi i y / R_y). \tag{6.10}$$

As for the 2d chiral model in §. 3.1, we perform the complex gauge transformation to the standard ‘point basis’ topological gauge. From the definition

$$V(\mu, \bar{\mu}, x) = \frac{R_x}{2} v(\mu) + \frac{R_x}{2} \bar{v}(\bar{\mu}) + \frac{R_x}{2} \partial_x L(\mu, \bar{\mu}, x) \tag{6.11}$$

we find

$$L_\Delta(m, x, y) = -\frac{1}{2\pi i} \sum_{\substack{k, \ell \in \mathbb{Z} \\ k \neq 0}} \frac{R_y}{k \sqrt{R_x^2 k^2 + R_y^2 \ell^2}} e^{2\pi i k x + 2\pi i \ell y - \sqrt{R_y^2 \ell^2 + R_x^2 k^2} |m|} \tag{6.12}$$

and

$$v_\Delta(\mu) = \log(1 - e^{-4\pi R_y \mu}). \tag{6.13}$$

This is a natural regularization of the $\sum_n \log(\mu + i \frac{n}{2R_y})$ arising from the KK tower. By the same token, we propose

$$a_\Delta(\mu) = \frac{1}{2} \log(1 - e^{-4\pi R_y \mu}). \tag{6.14}$$

We can then go to the ‘‘point topological basis’’ by the complexified gauge transformation with parameter $\frac{1}{2}L(\mu, \bar{\mu}, x) - \frac{1}{2}a - \frac{1}{2}\bar{a}$ (cfr. eqn.(3.34)):

$$\begin{aligned} \frac{1}{R_x} C_\mu &= \partial_x + v(\mu) \\ -\frac{1}{R_x} \bar{C}_{\bar{\mu}} &= \partial_x - \bar{v}(\bar{\mu}) - \partial_x L(\mu, \bar{\mu}, x) \\ D_\mu &= \partial_\mu + \partial_\mu a(\mu) - \partial_\mu L \\ D_{\bar{\mu}} &= \partial_{\bar{\mu}} \end{aligned} \tag{6.15}$$

We recognize that $v_\Delta(\mu) = \partial_\mu W_\Delta(\mu)$, where

$$W_\Delta \propto \text{Li}_2(e^{-m R_y - 2\pi i y}) \tag{6.16}$$

is the twisted effective superpotential for a compactified 3d chiral multiplet with a $-1/2$ CS level.

²⁰ For convenience, we absorb the overall dependence of the tt^* geometry on the length R_x in the definition of C_μ .

6.1.1 Evaluation of the elongated S^3 partition function $Z_{S^3} = S_{00}$

In this example with a single vacuum, the S_0^0 , or equivalently the partition function on the infinitely elongated S^3 should reduce, as discussed in §.5.5, to the gauge transformation which relates the Abelian monopole fields in the topological gauge (6.15) to the same fields written in the \mathbf{S} -dual topological gauge based on the 2d tt^* geometry for the opposite choice of “internal” circle, in which the parameter μ is replaced by its dual

$$\mu_x = \mathbf{S}(\mu) \equiv \frac{1}{4\pi} \left(m - \frac{2\pi i x}{R_x} \right). \quad (6.17)$$

To simplify the notation, we shall denote the effect of the action of \mathbf{S} on any quantity by a tilde, that is, for all quantities f we set

$$\tilde{f}(x, y, m, R_x, R_y) = \mathbf{S}f(x, y, m, R_x, R_y) \equiv f(y, -x, m, R_y, R_x). \quad (6.18)$$

Gauge invariant scalar quantities s satisfy $\tilde{s} = s$; in particular, $\tilde{V} \equiv V$.

To compare the topological gauge with its \mathbf{S} -dual it is convenient to preliminary transform these two complex gauges in the corresponding unitary gauges by the inverse of the gauge transformation in eqn.(6.15) of imaginary parameter

$$\frac{1}{2}K \equiv \frac{1}{2}(L - a - \bar{a}), \quad \text{resp.} \quad \frac{1}{2}\tilde{K} \equiv \frac{1}{2}(\tilde{L} - \tilde{a} - \bar{\tilde{a}}). \quad (6.19)$$

The two dual unitary connections A and \tilde{A} are, respectively,

$$\begin{aligned} A_m &= -\frac{R_y}{4\pi} \partial_y K & \tilde{A}_m &= \frac{R_x}{4\pi} \partial_x \tilde{K} \\ A_y &= \frac{\pi}{R_y} \partial_m K & \tilde{A}_y &= \frac{i}{2}(\tilde{v} - \bar{\tilde{v}}) \\ A_x &= \frac{i}{2}(v - \bar{v}) & \tilde{A}_x &= -\frac{\pi}{R_x} \partial_m \tilde{K} \\ V &= \frac{R_x}{2}(v + \bar{v}) + \frac{R_x}{2} \partial_x K, & V &= \frac{1}{2}(\tilde{v} + \bar{\tilde{v}}) + \frac{R_y}{2} \partial_y \tilde{K}, \end{aligned} \quad \text{resp.} \quad (6.20)$$

which satisfy the monopole equations

$$F = \tilde{F} = \frac{1}{2\pi} * dV. \quad (6.21)$$

These two $U(1)$ connections are gauge equivalent. Hence there is a real function Λ such that

$$A - \tilde{A} = d\Lambda. \quad (6.22)$$

The complete gauge transformation between the \mathbf{S} -dual topological gauge and the original one, which by the analysis in §.5.5 is the infinitely elongated S^3 partition function, is then the composition of the above three complex gauge transformations, that is,

$$S = \exp \left(-\frac{1}{2}K + i\Lambda + \frac{1}{2}\tilde{K} \right). \quad (6.23)$$

To compute Λ one starts from the known Fourier series for K

$$\begin{aligned}
K &= L - a - \bar{a} = \sum_{k,\ell} K(k, \ell; R_x, R_y) e^{2\pi i(kx+\ell y)} = \\
&= -\frac{1}{2\pi i} \sum_{\substack{k,\ell \in \mathbb{Z} \\ k \neq 0}} \frac{R_y}{k \sqrt{R_x^2 k^2 + R_y^2 \ell^2}} e^{2\pi i k x + 2\pi i \ell y - \sqrt{R_y^2 \ell^2 + R_x^2 k^2} |m|} + \\
&\quad + \frac{1}{2} \sum_{\ell \geq 1} \frac{e^{-\ell R_y m}}{\ell} (e^{2\pi i \ell y} + e^{-2\pi i \ell y}),
\end{aligned} \tag{6.24}$$

and the corresponding one for \tilde{K} with coefficients

$$\tilde{K}(k, \ell; R_x, R_y) \equiv K(-\ell, k; R_y, R_x). \tag{6.25}$$

Inserting these Fourier expansions in eqn.(6.20) one gets the expansions of the unitary connections A and \tilde{A} , and then we may read the Fourier series for Λ from eqn.(6.22). One gets

$$\begin{aligned}
\Lambda &= -\frac{1}{4\pi} \sum_{k,\ell \neq 0} \frac{1}{k\ell} e^{2\pi i k x + 2\pi i \ell y - \sqrt{R_y^2 \ell^2 + R_x^2 k^2} m} - \\
&\quad - \frac{i}{4} \left(\log(1 - e^{-R_y m + 2\pi i y}) - \log(1 - e^{-R_y m - 2\pi i y}) + \right. \\
&\quad \left. + \log(1 - e^{-R_x m - 2\pi i x}) - \log(1 - e^{-R_x m + 2\pi i x}) \right),
\end{aligned} \tag{6.26}$$

(in writing this equation we assumed $m > 0$).

As discussed in §.5.5, the partition function S given by (6.23) should also be equal to $\tilde{\Pi} \Pi^{-1}$ where Π are the $\zeta = \pm 1$ brane amplitudes. We shall check the validity of this relation after the computation of the amplitude Π .

6.1.2 Branes for the 3d free chiral theory

As we saw in §.3.1.3, the function Φ defined in eqn.(3.53) corresponds in 2d to either the Neumann or Dirichlet brane amplitude depending on the value of ζ . That analysis is important for the 3d free chiral theory with real twisted mass m , compactified on a circle of length R_y , which may be seen as a 2d (2, 2) model with an infinite collection of decoupled KK modes as in eqn.(6.2). Again, since the modes do not interact, the brane amplitudes are given by an infinite product of the single mode amplitudes of section 3.1.2 with 2d twisted masses

$$4\pi\mu_n = m + \frac{2\pi i}{R_y}(n + y), \quad n \in \mathbb{Z}. \tag{6.27}$$

To select a reasonable boundary condition for the 3d chiral field, we need to choose the boundary conditions of the individual 2d KK modes Y_n in a coherent way. The

most obvious choice is to seek either Dirichlet or Neumann b.c. for the 3d chiral field. This means selecting either Dirichlet b.c. for all the KK modes Y_n , or Neumann for all the Y_n . The complete 3d “Dirichlet”/“Neumann” amplitudes are

$$\begin{aligned} \frac{\log\langle x|D;\zeta\rangle}{\log\langle x|N;\zeta\rangle} &= -\frac{R_x}{4\pi R_y} \left(\zeta \operatorname{Li}_2(e^{-m R_y - 2\pi i y}) - \zeta^{-1} \operatorname{Li}_2(e^{-m R_y + 2\pi i y}) \right) + \\ &\quad -\frac{R_x R_y}{16\pi} \left[\zeta \left(m + \frac{2\pi i y}{R_y} \right)^2 + \zeta^{-1} \left(m - \frac{2\pi i y}{R_y} \right)^2 \right] - \\ &\quad -\frac{1}{2} \log \left[2 \sinh \left(\frac{1}{2} (m R_y + 2\pi i y) \right) \right] + \Phi_D(m, x, y, R_x, R_y; \zeta) \\ &\quad + \Phi_N(m, x, y, R_x, R_y; \zeta). \end{aligned} \quad (6.28)$$

where Φ_D, Φ_N are the sums over all KK modes of the 2d functions Φ with, respectively, Dirichlet and Neumann b.c. However, from §.5.7 we know that the physically interesting amplitudes, corresponding to proper Neumann/Dirichlet branes in the 3d sense, are the ones at fixed points of the Cayley transform \mathbf{C} , namely $\zeta = \pm 1$.

In order to write a sum over the KK modes having better convergence properties, it is convenient to rewrite the integral representation of the 2d thimble amplitude function Φ in a slightly more general form

$$\begin{aligned} \Phi &= \frac{1}{2\pi i} \int_L \frac{dt}{t - i\zeta} \log \left(1 - e^{-2\pi(\mu t + \bar{\mu} t^{-1} - ix)} \right) - \\ &\quad - \frac{1}{2\pi i} \int_L \frac{dt}{t + i\zeta} \log \left(1 - e^{-2\pi(\mu t + \bar{\mu} t^{-1} + ix)} \right), \end{aligned} \quad (6.29)$$

where $L = e^{i\phi} \mathbb{R}_+$ is a ray in the complex plane such that: *i*) $\operatorname{Re}[t\mu] > 0$ for $t \in L$ and *ii*) the integrand has no pole in the angular sector $0 \leq \arg t \leq \phi$.

Assuming the real mass m in eqn.(6.27) to be positive, and setting

$$z = m R_x + 2\pi i \frac{R_x}{R_y} y, \quad (6.30)$$

we write the 3d function $\Phi[\zeta]$ in the form

$$\begin{aligned} \Phi[\zeta] &= \frac{1}{2\pi i} \int_{L^-} \frac{dt}{t - i\zeta} \log \prod_{n < 0} \left(1 - e^{2\pi i x - zt/2 - \bar{z}t^{-1}/2 - \pi i n \frac{R_x}{R_y} (t - t^{-1})} \right) + \\ &\quad + \frac{1}{2\pi i} \int_{L^+} \frac{dt}{t - i\zeta} \log \prod_{n \geq 0} \left(1 - e^{2\pi i x - zt/2 - \bar{z}t^{-1}/2 - \pi i n \frac{R_x}{R_y} (t - t^{-1})} \right) - \\ &\quad - \frac{1}{2\pi i} \int_{L^-} \frac{dt}{t + i\zeta} \log \prod_{n < 0} \left(1 - e^{-2\pi i x - zt/2 - \bar{z}t^{-1}/2 - \pi i n \frac{R_x}{R_y} (t - t^{-1})} \right) - \\ &\quad - \frac{1}{2\pi i} \int_{L^+} \frac{dt}{t + i\zeta} \log \prod_{n \geq 0} \left(1 - e^{-2\pi i x - zt/2 - \bar{z}t^{-1}/2 - \pi i n \frac{R_x}{R_y} (t - t^{-1})} \right) - \end{aligned} \quad (6.31)$$

where L^- is a ray in the upper-right quadrant and L^+ in the lower-right quadrant, and we assume that the poles at $t = \pm i\zeta$ are not in the angular sector bounded

by L^+, L^- and containing the positive real axis. Note that for the physical values, $\zeta = \pm 1$, the rays L^\pm may be chosen arbitrarily in the respective quadrants.

From the discussion in §.3.1.3, we know that this expression corresponds to a “Dirichlet” amplitude for $\text{Re } \zeta < 0$ and a “Neumann”; amplitude for $\text{Re } \zeta > 0$

$$\Phi[\zeta] = \begin{cases} \Phi_N[\zeta] & \text{for } \text{Re } \zeta > 0 \\ \Phi_D[\zeta] & \text{for } \text{Re } \zeta < 0. \end{cases} \quad (6.32)$$

To get the “Neumann” (resp. “Dirichlet”) amplitude in the opposite half-plane one has to analytically continue the above expression, by deforming the contours while compensating the discontinuity each time one crosses a pole of the integrand. The physical amplitudes are then obtained by specializing the result to $\zeta = \pm 1$.

The expression (6.31) may be written in a more suggestive form by introducing the compact quantum dilog function

$$\Psi(z, q) \equiv (z q^{1/2}; q)_\infty = \prod_{n=0}^{\infty} (1 - z q^{n+1/2}), \quad (6.33)$$

the product being convergent for $|q| < 1$. Then

$$\begin{aligned} \Phi[\zeta] &= \frac{1}{2\pi i} \int_{L^-} \frac{dt}{t - i\zeta} \log \Psi(e^{2\pi i x - zt/2 - \bar{z}t^{-1}/2 - i\frac{\pi R_x}{2R_y}(t-t^{-1})}, e^{i\pi \frac{R_x}{R_y}(t-t^{-1})}) \\ &+ \frac{1}{2\pi i} \int_{L^+} \frac{dt}{t - i\zeta} \log \Psi(e^{2\pi i x - zt/2 - \bar{z}t^{-1}/2 - i\frac{\pi R_x}{2R_y}(t-t^{-1})}, e^{-i\pi \frac{R_x}{R_y}(t-t^{-1})}) \\ &- \frac{1}{2\pi i} \int_{L^-} \frac{dt}{t + i\zeta} \log \Psi(e^{2\pi i x - zt/2 - \bar{z}t^{-1}/2 - i\frac{\pi R_x}{2R_y}(t-t^{-1})}, e^{i\pi \frac{R_x}{R_y}(t-t^{-1})}) \\ &- \frac{1}{2\pi i} \int_{L^+} \frac{dt}{t + i\zeta} \log \Psi(e^{-2\pi i x - zt/2 - \bar{z}t^{-1}/2 - i\frac{\pi R_x}{2R_y}(t-t^{-1})}, e^{-i\pi \frac{R_x}{R_y}(t-t^{-1})}), \end{aligned} \quad (6.34)$$

all integrals being absolutely convergent for L^\pm as above.

The asymmetric UV limit. The asymmetric limit of the amplitudes $\langle x|N, \zeta \rangle$, $\langle x|D, \zeta \rangle$ as ‘ $\bar{\beta} \rightarrow 0$ ’ is given by a regularized sum of the asymmetric limit for each KK mode, and is computed in appendix B.2. Not surprisingly, the limit is a quantum dilogarithms

$$\begin{aligned} \log \Pi_{3d}(\zeta = -1) &= -\log \Psi(e^{-mR_y - 2\pi i y - 4\pi x - 2\pi R_y/R_x}; e^{-4\pi R_y/R_x}) - \\ &- \frac{R_y}{4R_x} \left(m + \frac{2\pi i R_x}{R_y} y \right) - x \log \sinh \left[\frac{1}{2} (mR_y + 2\pi i y) \right] + \text{const.}, \end{aligned} \quad (6.35)$$

Indeed, by the same argument as in §.3.1.3 in this limit the amplitude is holomorphic in $z = mR_x + 2\pi i R_x y / R_y$ and it satisfies a difference equation of the form

$$\begin{aligned} \Pi_{3d}(z + 4\pi) &= \left(\prod_{n \in \mathbb{Z}} \left(\frac{z}{4\pi} + \frac{iR_x n}{2R_y} \right) \right) \Pi_{3d}(z) = \\ &= \left(1 - e^{-mR_y - 2\pi i y} \right) e^{(mR_y + 2\pi i y)/2} \Pi_{3d}(z), \end{aligned} \quad (6.36)$$

where the factor $e^{(mR_y+2\pi iy)/2}$ may be understood as arising from the \mathbb{Z}_2 anomaly of the free chiral at CS level zero. Not only this result confirms that in this asymmetric limit we obtain the result for the partition function of free chiral theory on S_b^3 and $S^2 \times S^1$ which are made of quantum dilogs, when the twist parameters $x, y = 0$, but it also predicts when $x, y \neq 0$ the result for these partition functions with twist line operators inserted at the two ends of the sphere.

6.1.3 The $\zeta = \pm 1$ amplitudes and the S -gauge transformation

In this subsection we check that the explicit expression (6.34) for the brane amplitudes $\Pi[\zeta = \pm 1]$ satisfies the expected relation with the elongated S^3 partition function, that is, the equality

$$\log \Pi[\zeta = \pm 1] - \log \tilde{\Pi}[\zeta = \pm 1] = \log S, \quad (6.37)$$

where S is the gauge transformation which, as described in §. 5.5, gives the partition function on the elongated S^3 .

We know explicitly the RHS of eqn.(6.37) in the form of a double Fourier series

$$\log S = \sum_{k, \ell \in \mathbb{Z}} c(m; k, \ell) e^{2\pi i(kx + \ell y)}, \quad (6.38)$$

while the LHS is known in the form of the integral representations (6.31)(6.34). The easiest way to check the validity of the equality (6.37) is to compute the Fourier coefficients of the LHS, which is known to be a periodic function of x, y , and compare them with the $c(m; k, \ell)$'s. The Fourier coefficients $c(m; k, \ell)$ may be read from eqns.(6.37)(6.24)(6.26); for²¹ $k\ell \neq 0$ they are

$$\begin{aligned} -4\pi i c(m; k, \ell) = & \left(\frac{R_x}{\ell \sqrt{R_x^2 k^2 + R_y^2 \ell^2}} - \frac{1}{k\ell} + \frac{R_y}{k \sqrt{R_x^2 k^2 + R_y^2 \ell^2}} \right) \times \\ & \times \exp\left(-\sqrt{R_x^2 k^2 + R_y^2 \ell^2} |m|\right). \end{aligned} \quad (6.39)$$

The $k\ell \neq 0$ coefficients in the Fourier expansion of $\log \Pi[\zeta = \pm 1]$ coincide with the coefficients in the Fourier series of the non-trivial part of the amplitude

$$\Phi[\zeta = \pm 1] = \sum_{k, \ell \in \mathbb{Z}} \Phi_{\pm}(k, \ell) e^{2\pi i(kx + \ell y)}. \quad (6.40)$$

We compute the coefficients $\Phi_{\pm}(k, \ell)$ for $k > 0$; the ones for $k < 0$ are similar. The terms with $k > 0$ arise from the first two integrals in eqn.(6.31). Expanding in series

²¹ The terms with $k\ell = 0$ correspond to purely holomorphic gauge transformations which just change the holomorphic basis in the chiral ring \mathcal{R} and hence are convention dependent.

the integrands, they become

$$\begin{aligned}
& -\frac{1}{2\pi i} \sum_{k \geq 1} \frac{e^{2\pi i k x}}{k} \sum_{n \geq 0} \int_{L^+} \frac{dt}{t - i\zeta} e^{-kz t/2 - k\bar{z} t^{-1}/2 - \pi i \frac{R_x}{R_y} (t - t^{-1}) k n} \\
& -\frac{1}{2\pi i} \sum_{k \geq 1} \frac{e^{2\pi i k x}}{k} \sum_{n < 0} \int_{L^-} \frac{dt}{t - i\zeta} e^{-kz t/2 - k\bar{z} t^{-1}/2 - \pi i \frac{R_x}{R_y} (t - t^{-1}) k n}, \quad (6.41)
\end{aligned}$$

which is already in the Fourier series form with respect to x . To get the double Fourier series one has to Poisson re-sum the KK modes. To do that, we deform the contours L^\pm to their original position on the positive real axis. For $\zeta = \pm 1$ we get

$$\begin{aligned}
& -\frac{1}{2\pi i} \sum_{k \geq 1} \frac{e^{2\pi i k x}}{k} \int_0^\infty \frac{dt}{t \mp i} e^{-kz t/2 - k\bar{z} t^{-1}/2} \sum_{n \in \mathbb{Z}} e^{-i\pi \frac{R_x}{R_y} (t - t^{-1}) k n} = \\
& = -\frac{1}{2\pi i} \sum_{k \geq 1} \frac{e^{2\pi i k x}}{k} \sum_{\ell \in \mathbb{Z}} \int_0^\infty \frac{dt}{t \mp i} e^{-kz t/2 - k\bar{z} t^{-1}/2} \delta\left(\frac{R_x}{2R_y} k(t - t^{-1}) - \ell\right) = \\
& = -\frac{1}{2\pi i} \sum_{k \geq 1} \frac{e^{2\pi i k x}}{k} \sum_{\ell \in \mathbb{Z}} \int_0^\infty \frac{2R_y(t \pm i) dt}{R_x k(t + t^{-1})^2} e^{-kz t/2 - k\bar{z} t^{-1}/2} \delta\left(t - \frac{R_y \ell}{R_x k} - \sqrt{1 + \frac{R_y^2 \ell^2}{R_x^2 k^2}}\right).
\end{aligned}$$

Using eqn.(6.30), and recalling that we are assuming $m > 0$, the above expression becomes

$$-\frac{1}{4\pi i} \sum_{k \geq 1} \sum_{\ell \in \mathbb{Z}} \frac{R_y[\ell R_y \pm ik R_x + \sqrt{k^2 R_x^2 + \ell^2 R_y^2}]}{k(k^2 R_x^2 + \ell^2 R_y^2)} e^{2\pi i k x - 2\pi i \ell y - |m| \sqrt{k^2 R_x^2 + \ell^2 R_y^2}}, \quad (6.42)$$

so the $k\ell \neq 0$, $k > 0$ Fourier coefficients are

$$\Phi_\pm(k, \ell; R_x, R_y) = -\frac{1}{4\pi i} \frac{R_y[\pm ik R_x - \ell R_y + \sqrt{k^2 R_x^2 + \ell^2 R_y^2}]}{k(k^2 R_x^2 + \ell^2 R_y^2)} e^{-|m| \sqrt{k^2 R_x^2 + \ell^2 R_y^2}}. \quad (6.43)$$

For $k > 0$, $\ell < 0$ one has

$$\begin{aligned}
& \Phi_\pm(k, \ell; R_y, R_x) - \Phi_\pm(-\ell, k; R_x, R_y) = \\
& = -\frac{1}{4\pi i} \left(-\frac{1}{k\ell} + \frac{R_y}{k \sqrt{k^2 R_x^2 + \ell^2 R_y^2}} + \frac{R_x}{\ell \sqrt{k^2 R_x^2 + \ell^2 R_y^2}} \right) e^{-|m| \sqrt{k^2 R_x^2 + \ell^2 R_y^2}}, \quad (6.44)
\end{aligned}$$

which, comparing with eqn.(6.39), gives the equality (6.37).

6.2 The CP^1 sigma model

The next obvious step would be to seek a model which gives a smooth $SU(2)$ doubly-periodic monopole as the 3d tt^* geometry. In 2d we used the mirror to the CP^1 gauged linear sigma model for a similar purpose. It is natural to look at the 3d version of

the same theory: a 3d $U(1)$ gauge theory coupled to two chiral multiplets of charge 1. This theory has two flavor symmetries: an $SU(2)_m$ flavor symmetry with mass m , which rotates the chiral doublet, and an $U(1)_t$ “topological” flavor symmetry with mass parameter equal to the FI parameter t for the theory. In order to define the theory fully, we need to select a Chern-Simons level for the theory. We select level 0 for now.

This theory happens to enjoy surprising mirror symmetry properties. These mirror symmetries are manifest in the branches of vacua which appear for special choices of the mass parameters. If we turn on a positive FI parameter and no $SU(2)$ mass m , the theory has a standard $\mathbb{C}P^1$ moduli space of vacua, where the chiral fields receive a vev controlled by the FI parameter. If we turn on a mass parameter m , we can integrate out the chirals and seek for a Coulomb branch for the theory. As long as the Coulomb branch scalar σ is in the interval $2|\sigma| < m$, integrating away the chirals of opposite flavor charge gives no net Chern-Simons coupling for the $U(1)$ gauge field, but produces a mixed CS coupling between the gauge and flavor symmetry, which shifts the effective FI parameter to $t + |m|$. If we tune the mass parameters so that $t = -|m|$, we find a Coulomb branch with the topology of $\mathbb{C}P^1$ XXX [refs?]. In conclusion, the theory has three $\mathbb{C}P^1$ branches of vacua, which appear along the rays

$$\begin{aligned}
m = 0 & \quad t > 0 \\
t + m = 0 & \quad m > 0 \\
t - m = 0 & \quad m < 0
\end{aligned} \tag{6.45}$$

The mirror symmetries of the theory coincide with the permutation group of the three branches, and act on the mass parameters as the Weyl group of $SU(3)$ acts on the Cartan generators $(\frac{2}{3}t, \frac{1}{2}m - \frac{1}{3}t, -\frac{1}{2}m - \frac{1}{3}t)$. Indeed, the mirror symmetries imply that the $U(1)_t \times SU(2)_m$ flavor group in the UV is promoted to an $SU(3)$ flavor group in the IR.

The full tt^* geometry should thus enjoy the same S_3 Weyl symmetry acting over the combined parameter space $\mathbb{R}_m^3 \times \mathbb{R}_t^3$. It is thus more natural to describe the tt^* geometry as a bundle over $\mathbb{R}^3 \otimes \mathfrak{sl}(3)$. The theory has two vacua, and thus the bundle will be of rank two. Inspection of the spectral data computed in the previous section shows that the bundle has structure group $SU(2)$. The S_3 symmetry of the spectral data can be checked with some patience.

At fixed t , we can look at the bundle on \mathbb{R}_m^3 : the asymptotic behaviour of the Higgs field at large $|m|$ is $\text{diag}(|m|/2 - t/2, -|m|/2 + t/2)$, which is compatible with a single smooth doubly-periodic $SU(2)$ monopole. The t parameter controls the constant subleading asymptotics of the Higgs field. The half-integral slope at large $|m|$ is consistent for an $SU(2)$ bundle: it corresponds to the minimal possible Chern class of an $SU(2)$ bundle on T^2 .

At fixed m , we can look at the bundle on \mathbb{R}_t^3 : the asymptotic behaviour of the Higgs field at large positive t is $\text{diag}(t, -t)$, at large negative t (where the theory approaches a $\mathbb{C}P^1$ sigma model) is $\text{diag}(m/2, -m/2)$. Thus at large negative t the Higgs field goes to a constant diagonal vev, controlled by the parameter m . If m is set to zero, one finds instead a more complicated non-Abelian asymptotic behaviour, which is presumably associated to the low energy massless degrees of freedom of the $\mathbb{C}P^1$ sigma model. The asymptotics are again compatible with a single smooth doubly-periodic $SU(2)$ monopole. The m and t monopole geometries differ by the choices of Chern classes for the T^2 bundle at infinity.

It is also interesting to consider generalizations of this model with other Chern-Simons levels. We will do so in a later section, after we acquire some extra tools.

6.3 Main Example: Codimension 2 Defects

It turns out that the tt^* geometries in 2, 3 and 4 dimensions, can all be exemplified in the context codimension 2 defects of 4, 5 and 6 dimensional theories supporting 4 supercharges, which arise in the context of geometric engineering [9, 55, 56]. There are two equivalent descriptions of this class of theories. One starts either with M-theory on a local Calabi-Yau threefold, or equivalently [57], with a network of (p, q) 5-branes of type IIB [58]. This gives a theory in 5 dimensions. One then considers codimension 2 defects of this theory. In the M-theory setup, this corresponds to wrapping M5 branes over Lagrangian 3-cycles of CY, leading to a $3d \subset 5d$ defect, or in the (p, q) web description it can be viewed as D3 brane ending on the web.

This can lead to codimension 2 defects in 6 and 4 dimensions, and in particular to 4 dimensional defect probes of $(2, 0)$ and $(1, 0)$ supersymmetric theories in 6d as follows: Using M-theory/F-theory duality, by restricting to elliptic CY, this would correspond to $4d \subset 6d$ defects [62–64]. This is equivalent, in the (p, q) 5-brane web, to requiring the space to be periodic in one of the directions that the 5-branes wrap. To obtain the 4 dimensional theories, one simply considers type IIA on the corresponding Calabi-Yau, by compactifying the M-theory on the circle. In this context the (p, q) web becomes the skeleton of the associated Seiberg-Witten curve of the theory, and the 2d defects are associated to surface defects parameterized by points on the curve [9, 10]. This can also be described in purely gauge theoretic terms [14].

In this section we focus on the $3d \subset 5d$ defects, and use the (p, q) 5-brane web description, which is particularly convenient for our purposes (see Fig. 13).

The slope of the (p, q) 5-brane is p/q due to supersymmetry (at type IIB coupling constant $\tau = i$). We consider the 3d theory obtained by having an extra D3 brane ending on the web. To make the theory dynamical we need a finite length D3 brane and for this purpose we need an extra spectator brane (these were originally introduced in [10] in the M-theory context and was related to framing of the associate knot invariants). In particular if we have a $v = (1, 0)$ brane and a $w = (p, q)$ brane with a D3 brane stretched between them we get an $\mathcal{N} = 2$ supersymmetric Chern-

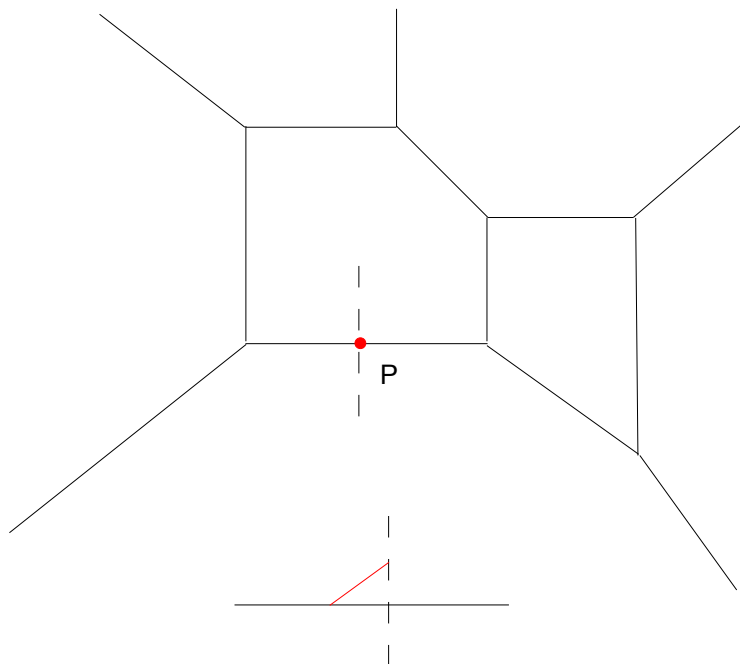

Figure 13: A web of (p, q) 5-branes engineers a 5d theory. D3 branes (red line) suspended between the web and a spectator brane (dashed line) gives rise to a 3d theory which can be viewed as a defect of the 5d theory. Changing the slope of the spectator brane corresponds to the $SL(2, \mathbb{Z})$ action on the 3d theory.

Simons theory in 3d with CS level $v \wedge w = q$ with the associated monopole flavor symmetry with CS level at level p [47] (see Fig. 14).

In particular the $SL(2, \mathbb{Z})$ action of Witten [4] on the space of 3d theories with $U(1)$ flavor symmetry corresponds to $SL(2, \mathbb{Z})$ action on the spectator brane, where the T operation adds a unit background CS coupling and the S operation gauges the flavor symmetry. For definiteness we will take the spectator brane to be a $(1, 0)$, and act by $SL(2, \mathbb{Z})$ on the rest of the web.

Consider the case of $(p, q) = (1, k)$. This is a pure $U(1)_k$ Chern-Simons theory. The 3d theory is massive and the σ field is frozen at $k\sigma = t$. The changing of t corresponds to moving the spectator brane (see Fig. 14). In this context the above relation gets interpreted as follows: (t, s) can be viewed as the (x, y) component of the D3-brane, which is at the intersection of the projection of the two 5-branes on the plane.

We can also consider compactifications of these theories on a circle. The corre-

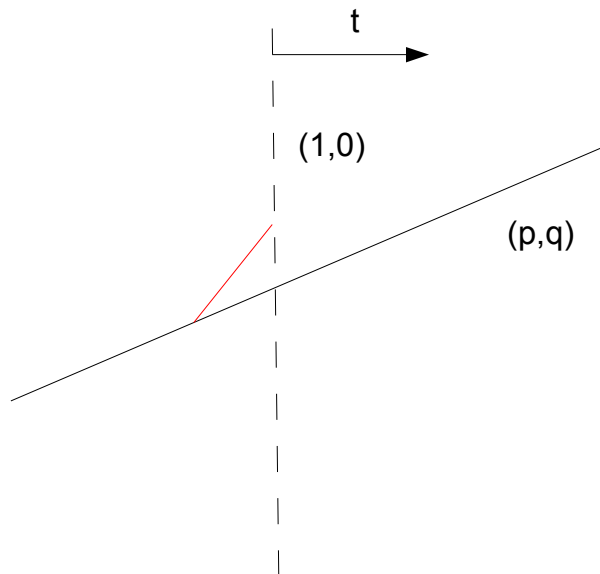

Figure 14: The suspended D3 brane gives rise to a $U(1)$ Chern-Simons theory at level $v \wedge w = q$. Moving the spectator brane by t corresponds to changing the FI term by t .

sponding web geometry becomes the Seiberg-Witten curve which generically takes the form

$$f(s, t) = \sum c_{n,m} e^{nt+ms} = \sum c_{mn} T^n S^m = 0$$

where $S = e^s$, $T = e^t$. In particular the points $(n, m) \in \mathbb{Z}^2$ such that $c_{m,n} \neq 0$ form a convex polygon. Moreover the semi-infinite 5-branes correspond to pairs of adjacent points on the edges of the polygon. If (n_1, m_1) and (n_2, m_2) are two adjacent points on the edge of the polygon, there is a (p, q) 5-brane with

$$(p, q) \wedge (n_1 - n_2, m_1 - m_2) = p(m_1 - m_2) - q(n_1 - n_2) = 0$$

(for a recent discussion see [59]). Moreover, from the 3d probe theory we get a 2d theory with $(2, 2)$ supersymmetry. As was shown in [9] the corresponding Seiberg-Witten curve can be interpreted as the spectral curve of the 2d theory in the following sense: The 2d theory has t as a parameter and has a field Σ . Moreover $f(s, t) = 0$ corresponds to the spectrum of $\Sigma = s$ for the fixed value of t . In other words there is a superpotential $W(\Sigma, t) = W_0(\Sigma) + t\Sigma$ which satisfies

$$\Sigma = -\partial_t W$$

and

$$\partial_\Sigma W_0 + t = 0 \iff f(s, t) = 0.$$

Another way of saying this is that locally solving $t(s)$ using $f(s, t) = 0$ leads to solving for a branch of W

$$W(\Sigma) = \int^{\Sigma} t(s) ds - t\Sigma.$$

In other words, the spectral geometry of the line operators of the 3d theory wrapped around the circle is the SW curve. Note that there are in general multiple vacua. For example, considering the $U(1)_k$ theory discussed above, upon compactification on a circle we find k vacua, where the spectral curve becomes

$$e^{ks} = e^t. \tag{6.46}$$

In other words the 3d loop operator S satisfies the relation $S^k = T$. Defining $\tilde{S} = S/(T^{1/k})$ we see that

$$\tilde{S}^k = 1$$

We recognize this as the Verlinde algebra of $U(1)_k$ [48]. Indeed this is the familiar result for the loop operator of a $U(1)$ Chern-Simons theory at level k [44], where \tilde{S} is equivalent to the Wilson loop operator wrapped around the circle, in the fundamental representation of $U(1)$.

In fact we can do more: We can suspend N D3 branes between the 5-branes. In this case we would get an $\mathcal{N} = 2$ $U(N)$ Chern-Simons gauge theory at level k . In this context the field \tilde{S} should be viewed as an $N \times N$ matrix valued loop operator. The relation $\tilde{S}^k = 1$ still holds. This means that we choose N eigenvalues at k -th roots of unity. Using the fact that gauge symmetry acts as permutation of the eigenvalues we see that the number of inequivalent vacua are now given by

$$\frac{k(k+1)\dots(k+N-1)}{N!}$$

which is the same as the dimension of the Verlinde algebra for $U(N)$ conformal theory at level k . Indeed the resulting ring of the line operators is isomorphic to the Verlinde ring.

We now wish to study the tt^* geometry of these 3d systems. Having a single probe will lead to 3d monopole systems on $T^2 \times \mathbb{R}$, *i.e.* doubly periodic monopole $SU(n)$ systems if we have n vacua²². Indeed such a system was already studied in [40] and in particular it was noted there that the spectral curve associated to the doubly-periodic monopole equations are captured by the SW curve of the above physical system. Here we are finding a physical explanation of why the corresponding web appeared as part of a solution to the monopole equations. We now give a brief review of their results. We refer to reference [40] for more details.

²²The construction can probably be generalized to other classical groups by a judicious use of orbifolds.

The basic idea is that the moduli spaces of doubly-periodic monopoles on $(\mathbb{R} \times T^2)_t$ are labelled by the coefficients Q_\pm of the linear growth of the Higgs field at large $|t|$, by the constant subleading coefficients M_\pm in the Higgs field at large $|t|$, and by two sets of angles p_\pm and q_\pm which from our point of view combine with M_\pm to give other doubly-periodic deformation directions of the tt^* geometry. Other parameters are the locations t_i in $(\mathbb{R} \times T^2)_t$ of the Dirac monopole singularities. These give other doubly-periodic deformation directions of the tt^* geometry. A certain linear combination of these parameters is redundant: a translation of $(\mathbb{R} \times T^2)_t$ will in general shift the r_i and possibly the (M, p, q) by multiples of the Q .

The spectral curve for the doubly-periodic geometry is then given by an equation of the general form

$$\sum c_{n,m} e^{nt} e^{ms} = 0 \tag{6.47}$$

where the (n, m) integer points for non-zero $c_{n,m}$ form a convex Newton polygon in the plane. The shape of the polygon encodes the Q_\pm coefficients and the coefficients on the boundary of the polygon encode the (complexified) M_\pm and t_i data. The coefficients of the interior coefficients are moduli of the periodic monopole configuration. More precisely, the monopole moduli space is parameterized by a choice of spectral curve with given (M, p, q, t_i) and of a line bundle on it. Each interior point of the Newton polygon gives two complex parameters: a coefficient in the spectral curve and a modulus for the line bundle. Indeed, the monopole moduli space is an hyperKähler manifold.

It is now clear that the same geometry is describing the tt^* solutions of 3d theory on the probes of our 5-brane web system compactified on T^2 , where the real Coulomb branch moduli of the bulk 5d theory combine with the gauge Wilson lines and the dual photons to give the hyperKähler geometry of the doubly-periodic monopole moduli space. The mass deformation parameters correspond to the M_\pm and t_i parameters. As already noted, the probes are a $D3$ brane segment stretched from the (p, q) brane web to a separate $(1, 0)$ brane lying on a plane parallel to the plane of the web and the position of the $(1, 0)$ brane the $D3$ brane ends on becomes the (FI) mass parameter t and the tt^* geometry corresponding to the t deformation becomes the doubly-periodic monopole geometry.

We can now reinterpret our previous examples as brane webs, and then add a few more.

A single 3d chiral multiplet, or better the T_Δ theory, can be engineered by a web including a $(-1, 0)$, a $(0, 1)$ and a $(1, -1)$ fivebranes coming together to a point [47]. This configuration is rigid. The obvious \mathbb{Z}_3 symmetry generated by the ST $SL(2, \mathbb{Z})$ duality transformation corresponds to the basic mirror symmetries of the T_Δ theory [45]. To be precise, if the $D3$ brane probe ends on an $(1, 0)$ brane parallel to the web we get the description of the theory as an $U(1)$ CS theory at level $1/2$, coupled to a single chiral of charge 1.

The slopes of the fivebranes, -1 for negative t and 0 for positive t match the background CS couplings for the $U(1)_t$ flavor symmetry and the asymptotic values of the Higgs field in the monopole solution. The spectral curve is

$$e^s = 1 - e^{-t} \quad (6.48)$$

This is also consistent with the relation we found for the loop operator associated with a chiral field with mass parameter t , which we obtain by ungauging the $U(1)$, by converting the spectator $(1, 0)$ brane to a $(0, 1)$ brane.

Next, we can look at an $U(1)_{k-\frac{1}{2}}$ Chern-Simons theory coupled to a chiral of charge 1. For large negative t we have two branches of vacua in flat space: either $\sigma = 0$ and the chiral gets a vev or we integrate away the chiral and we have an effective CS level $k - 1$ and $(k - 1)\sigma = t$. For large positive t we have one branch of vacua only: we integrate away the chiral and have an effective CS level k , with $k\sigma = t$. Thus we expect a brane system with a $(1, k)$ fivebrane, a $(0, 1)$ fivebrane and a $(1, k - 1)$ fivebranes.

As our next example we consider the brane description for the 3d $\mathbb{C}P^1$ gauge theory with twisted mass. In order to describe the algebra of the wrapped loop operators when we compactly the theory to 2d on S^1 we view the 3d model as a 2d model with infinite towers of KK modes. The (twisted) superpotential is

$$W = \sum_{n \in \mathbb{Z}} \left[e^{Y_n^+} + e^{Y_n^-} - (i n + t_2 + \Sigma) Y_n^+ - (i n - t_2 + \Sigma) Y_n^- \right] + 2\pi t_1 \Sigma. \quad (6.49)$$

There are two distinct vacua satisfying

$$\begin{cases} \cosh(2\pi\Sigma_0) = \cosh(2\pi t_2) + \frac{1}{2} e^{2\pi t_1} \\ Y_n^\pm = \log(\Sigma_0 + i n \pm t_2). \end{cases} \quad (6.50)$$

One has

$$C_1 = \frac{\partial}{\partial x_1} + 2\pi\Sigma_0 \quad S_1 = e^{-2\pi\Sigma_0} \quad (6.51)$$

$$C_2 = \frac{\partial}{\partial x_2} + \log \frac{\sinh \pi(\Sigma_0 - t_2)}{\sinh \pi(\Sigma_0 + t_2)} \quad S_2 = \frac{\sinh \pi(\Sigma_0 + t_2)}{\sinh \pi(\Sigma_0 - t_2)}, \quad (6.52)$$

from which we get the equations for the spectral curve \mathcal{L}

$$S_1 + S_1^{-1} = T_2 + T_2^{-1} + T_1 \quad (1 - S_1 T_2) S_2 = T_2 - S_1. \quad (6.53)$$

It is easy to check that \mathcal{L} is indeed a Lagrangian submanifold of $(\mathbb{C}^*)^4$, as expected.

For the t geometry for the $\mathbb{C}P^1$ gauge theory, where we fix the mass parameter but vary t by moving the spectator brane, the first equation would need to be the spectral curve, where S_1, T_1 define the curve and T_2 is a parameter. In other words,

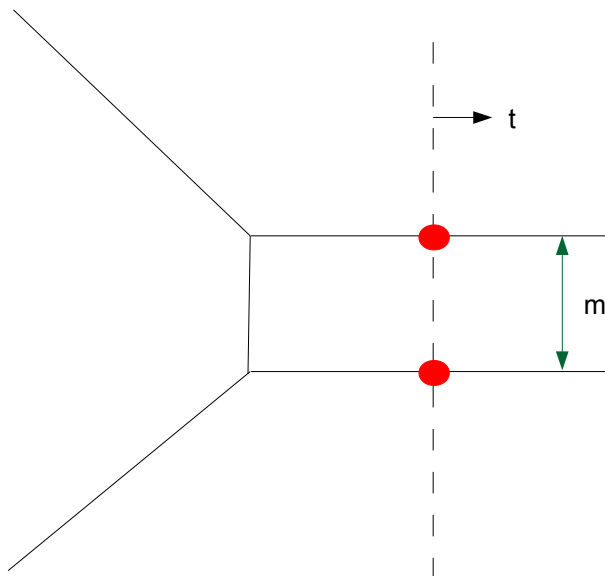

Figure 15: The web geometry which leads to $\mathbb{C}P^1$ gauge theory at CS level 0. The separation of the horizontal lines is controlled by the mass parameter associated to flavor symmetry rotating the two flavors in opposite directions. The movement of the spectator brane corresponds to changing the FI-parameter t .

the Newton polygon can be taken to include $(0, -1)$, $(0, 0)$, $(0, 1)$ and a $(-1, 0)$. Thus we need a $(1, 1)$ brane, a $(-1, 1)$ brane and two $(0, -1)$ branes (see Fig. 15).

The parallel $(0, -1)$ branes give rise to the $SU(2)_m$ flavor symmetry, and their separation is the parameter m . The spectral curve is the expected (where $t_2 = m/2 + i\pi$, $t_1 = t$).

$$e^s + e^{-s} = c_{0,0} + e^t \quad (6.54)$$

where $c_{0,0} = -e^{m/2} - e^{-m/2}$.²³

²³ We could also seek a five-brane geometry which would reproduce directly the m geometry for the $\mathbb{C}P^1$ gauge theory with zero CS level. Although it is straightforward put the spectral data in the correct form, up to a small redefinition $m \rightarrow 2t_m$, the spectral curve

$$e^{sm} + e^{-sm} = -e^{2t_m-t} + e^{t_m} + 2e^{-t} + e^{-t_m} - e^{-2t_m-t} \quad (6.55)$$

is non-generic: the corresponding brane system has normalizable moduli, and really engineers a more complex 3d-5d system. This is an important cautionary tale, which was encountered before in the context of 2d-4d systems. A given 3d theory may not have enough deformations to reproduce all moduli of a doubly-periodic monopole geometry, but rather it may produce some (usually somewhat special) slice of that moduli space. In 2d-4d examples, that slice is often a singular locus in the full moduli space. The physical interpretation is that the brane construction produces a larger theory. If we restrict the Coulomb branch moduli to the values which correspond to the original system's spectral curve, a Higgs branch may open up and an RG flow to the original system may become available by moving along the Higgs branch. It would be interesting to verify if the same picture

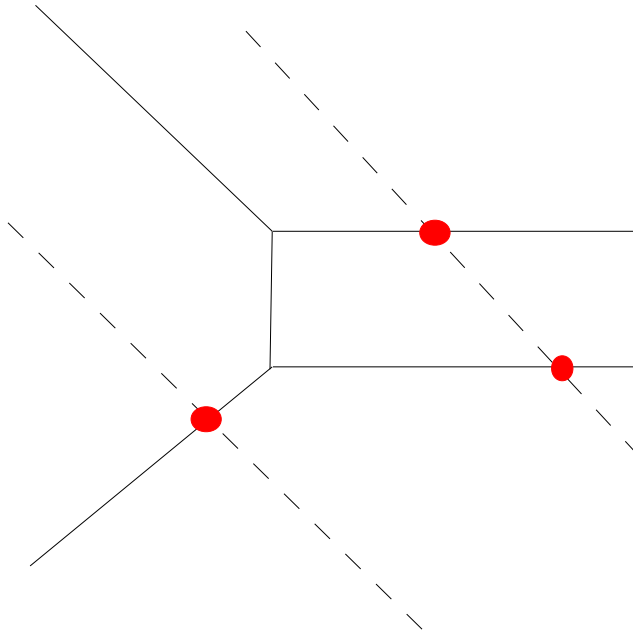

Figure 16: The web geometry which leads to $\mathbb{C}P^1$ gauge theory at CS level 1. Depending on the sign of the FI parameter t the 3d theory has 1 or 2 vacua. The one corresponding to 1 has degeneracy 2, in the sense that if we compactify the theory it splits into two distinct vacua. Having a vacuum geometry which splits upon compactification is a signature of non-trivial topological structure in the IR.

A final example is a $\mathbb{C}P^1$ theory with an extra CS coupling of 1. At large negative t we still have a $\mathbb{C}P^1$ sigma model, but for large positive t we now have a single branch with effective CS coupling 2. At $t = 0$ a semi-infinite Coulomb branch opens up. The brane system involves the same two $(0, 1)$ fivebranes, a $(1, 0)$ brane and an $(1, 2)$ fivebrane. For this case, it is more convenient to rotate the spectator brane to achieve the CS coupling 1, and not rotate the entire web. In particular we take the spectator brane to be a $(1, -1)$ brane instead of $(1, 1)$ brane, and use the same brane as the one for CS level 0 (see Fig. 16).

holds in the 3d-5d setup. It is also interesting to see if one can embed the D-model setup in [60] into string theory. If so, one can engineers arbitrary spectral geometries in higher dimensions in that way.

6.4 Loop operator algebras as deformed Verlinde Algebra

As discussed in §.5.6, we expect that for the massive 3d theories, in the infrared limit the theory become topological. In this section we give some examples of this and point out that these give a mass deformation structure to the Verlinde algebra, which would be potentially interesting for topological phases of matter.

Let us go back to the two 5brane system with branes $(1, 0), (1, k)$. This has k vacua in 2d, given by $S^k = e^t$. As already noted, suspending a D3 brane between them leads to a $U(1)_k$ Chern-Simons theory, and the $\mathcal{N} = 2$ loop algebra is isomorphic to the Verlinde algebra. Let us check how the S matrix computed in the $\mathcal{N} = 2$ context match up with that of the S-matrix of the Verlinde algebra. The S-matrix intertwines loop operators wrapping each of the two cycles of T^2 . Let us denote the generators of the two loop operators by S_a and S_b :

$$SS_aS^{-1} = S_b$$

Let us use a basis of vacua adapted to the S_a , where it acts (after suitably normalizing it) as

$$S_a|n\rangle = \omega^n|n\rangle$$

where ω is a primitive k -th root of unity. As discussed in §.5.6, the action of S_b for a $U(1)$ gauge theory is the same as the action of the holonomy of tt^* by going through a path where $\theta \rightarrow \theta + 2\pi$, with θ the imaginary part of t . In the IR, this holonomy can be computed easily in the point basis, and it corresponds to the permutation of the k vacua. In other words

$$S_b|n\rangle = |n + 1\rangle.$$

Since the S-matrix intertwines between them we learn that

$$S_{ij} = \frac{1}{\sqrt{k}} \omega^{ij}.$$

which agrees with the expected form of the S matrix for the Verlinde algebra of $U(1)_k$. This analysis can be extended to the case in which, instead of just one suspended D3 brane, we have N of them, giving the S-matrix for $U(N)_k$ CS theory. We leave checking the details to the reader.

Instead, we will focus on asking how such a structure gets realized in our models. Consider in particular the $\mathbb{C}P^1$ gauge theory at level 1 (see Fig. 16). This is a particularly interesting case, and is a special instance of the theories studied in [43], involving $U(N)_{k/2}$ coupled to k fundamental chiral fields, to explain the relation observed by Gepner [65] between the Verlinde algebra for $U(N)_k$ and the quantum cohomology ring for Grassmannian $Gr(N, k)$ [66, 67]. As already discussed, for $t \ll 0$ we expect to get a pure $U(1)$ CS theory at level 2, and thus the considerations of the previous discussion applies; in particular, in the IR we get the same structure as the 2d Verlinde algebra. On the other hand, one may ask what S-matrix structure do we

get for $t \gg 0$. In this case the theory is the $\mathbb{C}P^1$ sigma model. Let us also assume that in addition we have a mass parameter, and ask how the S-matrix behaves in this regime. Let us go to a basis in which the S_a operator is diagonal, and given by the intersection of the 5-brane with the brane web. This corresponds to two points on the 3d web, which become infinitely far away in the IR. Moreover, it is also clear that S_b which corresponds to the $\theta \rightarrow \theta + 2\pi$ is also diagonal in this basis, because the 3d vacua do not get permuted. This implies that in this regime of parameters the S matrix becomes trivial, *i.e.* the identity operator. This suggests that there is no non-trivial topological degrees of freedom in this regime of parameters. The tt^* geometry for the doubly periodic system thus interpolates between a trivial S-matrix in one regime of parameters, to the non-trivial S-matrix (corresponding to that of the Verlinde algebra) in a different regime. This is indeed exciting and is worth studying further.

The general structure which emerges from this discussion is that by looking at the 3d vacua we can determine if in the IR, upon compactification on an S^1 , we get a topologically non-trivial theory or not. In particular, if the 3d vacua reflect the degeneracy of the compactified theory, then the theory becomes trivial. This is the case when the projection of the spectator 5-brane with (p, q) type v to the 5-brane plane intersects the web in as many points as the vacua, which in turn is the case if the product of $v \wedge w_i = \pm 1$ for each 5-brane w_i it intersects. Otherwise at each intersection point we get the structure of a $U(1)_{v \wedge w}$ Verlinde algebra. Moreover if we consider having N suspended D3 branes the S-matrix in the IR will have the structure of the Verlinde algebra for

$$\prod_i U(N)_{v \wedge w_i}.$$

Clearly we have found a beautiful interplay between deformations of 2d RCFT's and geometry, captured by doubly periodic monopole equations, which should be further studied, especially in view of application to topological phases of matter.

6.5 Class R three-dimensional theories associated to three-manifolds

There is a rich class of three dimensional Abelian Chern-Simons matter theories which can be obtained from a product of m T_Δ theories, by acting with an arbitrary $\text{Sp}(2m, \mathbb{Z})$ transformation and adding certain superpotential couplings described in [45, 47, 61]. The main point of interest of this class of theories is that there is a large network of mirror symmetries relating different UV theories in the class, and the space of equivalence classes of IR SCFTs, dubbed “class R” in [45], seems to have a rich structure.

The spectral data for the tt^* geometry of a class R theory T , which coincides with the parameter space of supersymmetric vacua $\mathcal{L}[T]$ discussed in [45], is invariant under the mirror symmetries and is presented as the image of the product $\mathcal{L}[T_\Delta]^m$ of

parameter spaces of the individual chiral multiplets under the $\mathrm{Sp}(2m, \mathbb{Z})$ transformation and a toric symplectic quotient of $(\mathbb{C}^*)^{2m}$ determined by the choices of superpotentials. At the level of the tt^* doubly-periodic geometry itself, the $\mathrm{Sp}(2m, \mathbb{Z})$ transformation is the Nahm transform discussed in a previous section. The symplectic quotient is simply the restriction of the monopole data to a linear subspace in \mathbb{R}^{3m} , the locus where one sets to zero the mass parameters and flavor Wilson lines for the flavor symmetries broken by the superpotential terms.

There is a subset of class R theories T_M which are associated to certain decorated three-manifolds M : the data of the theory is constructed from a triangulation of the three manifold M , and the mirror symmetries insure invariance under 2-3 moves which relate different triangulations of the same manifold. Thus the final 3d SCFT only depends on the choice of manifold M , and so will the corresponding tt^* geometry. The construction is designed in such a way that the parameter space $\mathcal{L}[T_M]$ coincides with the space of flat $SL(2, \mathbb{C})$ connections on M . A typical example of M could be a knot complement in S^3 . It would be interesting to find a similar geometric relation between the three-dimensional geometry M and the tt^* geometry of T_M .

7 tt^* geometry in 4 dimensions

In this section we discuss the tt^* in 4 dimensions. The structure of the argument is very similar to that of the 3d case, except that in this case we have 2 distinct possibilities: We can discuss either flavor symmetries, which correspond to line operators, or 2-form symmetries which couple to conserved anti-symmetric 2-form. These arise in particular in theories with $U(1)$ gauge factors where we consider $B \wedge F$ terms as well as the FI term. We will see that in the case of flavor symmetries the parameter space is $(T^3)^r$ where r is the rank of the flavor symmetry group. In the case of 2-form symmetries, we find that the parameter space is $(T^3 \times R)^r$ where r is the number of 2-form symmetries. Furthermore the derivation of the 4d tt^* geometries proceed as in 3d case. We see that for the case of flavor symmetries the theory has sectors indexed by an integer n where W has a central charge $n\mu$ for a complex parameter μ . In the case of 2-form symmetries we see that there are sectors labeled by a pair of integers (n_1, n_2) for which W shifts by $(n_1 + n_2\rho)\mu$.

7.1 The case of flavor symmetries

Consider a theory in $4d$ where we take the space to be a flat torus T^3 with periodic boundary condition for fermions, preserving all supersymmetry. Let us assume this theory has a flavor symmetry of rank r . We can turn on fugacities for the rank r flavor group in the Cartan of the flavor group along each circle. Therefore the parameter space is

$$T^{3r},$$

modulo the action of the Weyl group²⁴. In order to develop the tt^* geometry for this theory, consider the first step, where we compactify the theory on a circle down to 3 dimensions. Then we get a theory with a flavor group of rank r . Moreover the twisted mass parameters of this 3d theory is identified with the fugacity of the flavor group around the circle. So, unlike the generic flavor group in 3d where the corresponding twisted mass parameter is parameterized by \mathbb{R} , the fugacities are periodic. This is the only difference from a generic 3d theory with flavor symmetry. Therefore the tt^* geometry is the same as in the generic case, namely the generalized monopole equations in $3r$ dimensions. Here the parameter space is the compact T^{3r} . The chiral operators of the 2d case now correspond to surface operators in the internal geometry (to see this note that the twist operators are codimension 2-operators, which is a surface operator in 4 dimension).

7.2 The case of 2-form symmetries

This is the case where the theory has a conserved anti-symmetric 2-form ‘current’ $J_{\mu\nu}$:

$$\partial_\mu J_{\mu\nu} = d * J = 0.$$

This couples to a background 2-form tensor field $B_{\mu\nu}$:

$$\int d^4x B \wedge *J$$

which we take to be flat. In the $\mathcal{N} = 1$ supersymmetric case the background tensor field is part of an $\mathcal{N} = 1$ tensor multiplet, which includes in addition a real scalar field ϕ whose constant vev deforms the theory. A generic way this structure appears is when we have a $U(1)$ gauge symmetry. In that case $J = *F$, which is conserved because $d * J = dF = 0$. The coupling to the background B field corresponds to a $\int d^4x B \wedge F$ term and the vev of the scalar field ϕ corresponds to the FI parameter for the $U(1)$ field. For each such 2-form symmetry, we have, in addition to the choice of the vev of ϕ which is generically parameterized by²⁵ \mathbb{R} , we choose a 2-form B on T^3 which is periodic (assuming, as is typically the case, that the integrals of $*J = F$ are quantized), which then is parametrized again by a T^3 . Thus, altogether, we get the parameter space $T^3 \times \mathbb{R}$. If we have r such 2-form symmetries this gives the parameter space becomes

$$(T^3 \times \mathbb{R})^r.$$

²⁴ This is the most general flavor twisting in T^3 whenever the flavor group is an Abelian group times a product of simple groups of isotype A_{N-1} and C_n which have all dual Coxeter labels equal 1. For more general flavor groups G_F , the space T^{3r}/Weyl gets replaced by the moduli space \mathcal{M}_3 of commuting triples in G_F which is a disconnected space (see [75, 76]). Restricting ourselves to the tt^* geometry of the largest connected component of \mathcal{M}_3 , we reduce back to the situation discussed in the text.

²⁵We will discuss some examples where the 4d theory is a probe in a 6d $(1,0)$ theory where the vev is parameterized by an S^1 , instead of \mathbb{R} . In such a case we get T^4 as the parameter space.

The 4 dimensional $\mathcal{N} = 1$ supersymmetric theories do admit BPS strings, with the central term being controlled by the scalar vev (which in the $U(1)$ gauge theory case corresponds to FI-term) in the tensor multiplet. Let us call this real parameter μ , which denotes the tension of the string. Now consider compactifying the theory on T^2 to 2-dimensions with a complex structure ρ . The parameter μ gets complexified by the component of the B_{12} along the T^2 . Let us call this x_{12} , *i.e.*

$$\mu \rightarrow \mu + i x_{12}.$$

In particular the strings will have a BPS tension proportional to μ . However now we have in addition a more refined sector in the 2d theory which will be labeled by a pair of integers n_1, n_2 depending on wrapping number of the string around the two cycles. Then the norm of the central term in this sector will be the length of the string times the tension, *i.e.*,

$$W_{n_1, n_2} = \mu(n_1 R_1 + i n_2 R_2)$$

where we have taken the T^2 to be a rectangular torus of radius R_1, R_2 . Redefining $\hat{\mu} = R_1 \mu$, we have

$$W_{n_1, n_2} = \hat{\mu}(n_1 + \rho n_2)$$

where ρ denotes the complex structure parameter for T^2 . We are thus in the same situation as doubly periodic W 's discussed in section 3. As discussed there, the tt^* geometry in that case become that of self-dual Yang-Mills and its generalizations to higher dimensions, corresponding to hyper-holomorphic connections.

The chiral operators of the 2d theory will now correspond to surface operators wrapped around the T^2 fiber over each point in the 2d theory. The fact that they are surface operators follows from the fact that they couple to μ whose imaginary part includes the expectation value of B along the T^2 which can be gauged away locally, and is only accessed by operators wrapping the entire T^2 .

7.3 Partition functions on elongated $S^3 \times S^1$ and $S^2 \times T^2$

Just as in the 3d case, we recall that the tt^* geometry has more information than just the vacuum bundle and in particular it has a preferred basis of vacua corresponding to chiral operators, coming from the topologically twisted path integral on semi-infinite cigar. Consider a rectangular T^3 geometry and choose one of the circles to be the circle we was to contract inside the cigar (see Fig. 17):

We can consider D-brane boundary conditions and we can compute this, as before, in terms of Π_i^a . Or we can consider capping another circle obtaining a compact geometry. Moreover we have three inequivalent choices to cap the other circle. If we choose the same circle to contract on the other cigar as well, we would be computing the usual $g_{i\bar{j}}$ metric and η_{ij} of the 2d theory depending on whether both cigars are

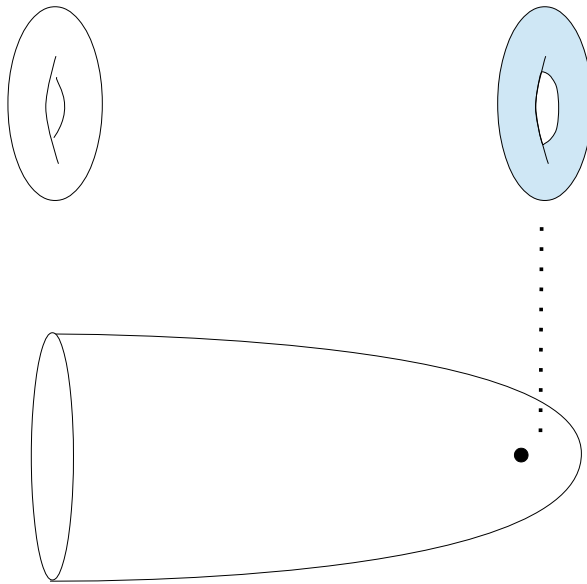

Figure 17: The states of the 4d theory on T^3 can be obtained by doing the path integral on an infinite cigar times T^2 , with surface operator, wrapping T^2 being inserted at the tip of the cigar.

topological, or one is topological and the other anti-topological. The path-integral for this configuration will have the topology of infinitely elongated $T^2 \times S^2$. On the other hand if we contract one of the other circles on the second cigar, we will get something which has the topology of infinitely elongated $S^1 \times S^3$. As explained in the context of the 3d problem these can all be computed. In this case the analog of S -transformation will be played by a non-abelian discrete subgroup of $SO(3, \mathbb{Z}) \subset SL(3, \mathbb{Z})$, generated by $\pi/2$ rotations of 12, 23, 31 planes.

7.4 Gauging and ungauging

As discussed in the context of Nahm transformation, we expect that making the flavor symmetry dynamical has the effect of mapping the tt^* geometry to its Nahm transform. In the context of a 4d theory with a $U(1)$ flavor symmetry, as already discussed, we expect to get monopole equations on T^3 . On the other hand for a gauge $U(1)$ symmetry we expect to get self-dual connections on $\mathbb{R} \times T^3$. Indeed the two are Nahm transforms of one another. In particular, if we consider the Fourier-Mukai transform of the self-dual connection on $\mathbb{R} \times T^3$ we expect a T-dual geometry, which gets rid of one dimension (given by \mathbb{R}) and maps T^3 to the dual T^3 , which is indeed the expected geometry for the dual system.

8 Examples of tt^* geometry in 4 dimensions

In this section we would like to discuss some examples of tt^* geometries which arise from four-dimensional $\mathcal{N} = 1$ theories compactified to 2d $(2, 2)$ on a torus of complex structure τ and area A . Although the analysis is not conceptually different from the 3d and 2d examples which appeared in the previous sections, the existence of various anomalies in four dimensions field theories complicate our work.

The basic example of a single free chiral multiplet in four dimensions illustrates well the situation. The KK reduction on a 2-torus gives us a double tower of 2d chiral multiplets, of masses $\mu_{k,n} = \mu + \frac{2\pi}{R_z}(k + \tau n)$, where k, n are the KK momenta and $R_z\mu = \theta_3 + \tau\theta_2$ is the complex combination of the two flavor Wilson lines on T_τ^2 , which behaves as a twisted mass parameter for the theory reduced to two dimensions. Correspondingly, we should expect the tt^* geometry to be a triply-periodic $U(1)$ BPS Dirac monopole solution, defined on the T^3 parameterized by the three flavor Wilson lines $\theta_{1,2,3}$, the standard $\theta_1 = 2\pi x$ and the internal $\theta_2 = 2\pi y$ and $\theta_3 = 2\pi z$.

There is an obvious problem with that: there are no (non-trivial) single-valued harmonic functions on a compact space. In other words, we can assemble the triply-periodic array of Dirac monopoles, but we cannot make the solution fully periodic in the three Wilson lines. For simplicity, let's take momentarily $\tau = i\frac{R_z}{R_y}$ and assemble a periodic array of the doubly-periodic monopole solutions we encountered in 3d. Formally this will correspond to a harmonic function of the form

$$V_{4d}(x, y, z) = v(z) + \sum_{(k,\ell) \neq (0,0)} V(k, \ell) e^{2\pi i k x + 2\pi i \ell y} \cosh \left[\frac{2\pi}{R_z} \sqrt{R_x^2 k^2 + R_y^2 \ell^2} \left(z - \frac{1}{2} \right) \right] \quad (8.1)$$

where

$$V(k, \ell) = -\frac{R_x R_y}{2 \sqrt{R_x^2 k^2 + R_y^2 \ell^2} \sinh \left[\frac{\pi}{R_z} \sqrt{R_x^2 k^2 + R_y^2 \ell^2} \right]}. \quad (8.2)$$

The harmonic function $V_{4d}(x, y, z)$ has a source which corresponds to the periodic array of doubly-periodic Dirac monopoles if and only if the first derivative of the zero-mode $v(z)$ has discontinuity $\frac{2\pi R_x R_y}{R_z}$ at all integer z . This is impossible for a function which is both harmonic and periodic; indeed harmonicity requires something like

$$v(z) = \frac{2\pi}{R_z} \left(\left(k + \frac{1}{2} \right) z - \frac{1}{2} k(k+1) \right) \quad k < z < k+1. \quad (8.3)$$

Thus the Higgs field fails to be periodic by $V(z+1) - V(z) = \frac{2\pi}{R_z}(z + \frac{1}{2})$. Correspondingly, the field strength of the gauge connection on the x - y torus will not be periodic in the z direction, but rather the total flux will increase by one as $z \rightarrow z+1$.

Of course, we can make slightly different choices to sacrifice periodicity, say, in the y direction and keep periodicity in the z direction.

The lack of periodicity is also visible from the twisted effective superpotential for a 4d chiral multiplet compactified to 2d, or better its first derivative. Indeed, the contribution of tt^* B -matrix (3.6), written as a sum of the corresponding matrices $B_{n,m}$ for the decoupled $Y_{n,m}$ KK modes, is²⁶

$$B = \sum_{n,m \in \mathbb{Z}} \log \left[\frac{z+n}{2R_z} + i \frac{y+m}{R_y} \right] \xrightarrow{\text{regularization}} \log \Theta \left(z + y\tau, \tau = i \frac{R_z}{R_y} \right), \quad (8.4)$$

where

$$\Theta(w, \tau) \equiv \theta_1(\pi w | \tau) = 2 \sum_{n=0}^{\infty} (-1)^n q^{\frac{1}{2}(n+\frac{1}{2})^2} \sin((2n+1)\pi w), \quad q = \exp(2\pi i\tau). \quad (8.5)$$

Under a translation $y \rightarrow y + 1$, the $\log \Theta(z + y\tau, \tau)$ shifts by

$$i\pi - 2\pi i(z + y\tau) - \pi i\tau.$$

This corresponds to the choice of V which fails to be periodic in the y direction.

Finally, we can express the problem in terms of the spectral curve

$$e^p = \Theta(z + y\tau, \tau) \quad (8.6)$$

which is not a well-defined curve in $\mathbb{C}^* \times T^2$.

The relation to the anomaly in the 4d flavor symmetry of a single chiral field becomes a bit more obvious if we imagine a collection of 4d chiral multiplets, having charges $q_i \in \mathbb{Z}$ under the flavor symmetry. The B_μ matrix (equal to the value of the derivative of the effective superpotential with respect to $\mu \equiv z + y\tau$ on the reference vacuum, cfr. §.4 satisfies

$$B_\mu = \sum_i q_i \log \Theta(q_i(z + y\tau), \tau). \quad (8.7)$$

Under a translation $y \rightarrow y + 1$ it shifts by

$$- \pi i(2\mu + \tau) \sum_i q_i^3 + i\pi \sum_i q_i^2 \quad (8.8)$$

Thus the coefficient of the dangerous shift linear in $\mu = z + y\tau$ is the coefficient of the total $U(1)^3$ anomaly. Eqn.(8.8) is equivalent to the statement that

$$\exp B_\mu \equiv \exp \left(\partial_\mu W |_{\text{vacuum}} \right)$$

²⁶ The sum is not absolutely convergent, and hence the order of summation matters (in particular, different orders lead to functions which fail to be periodic in different directions). Here the symmetric Eisenstein order convention is implied.

is a section of a line bundle L over the elliptic curve of period τ with Chern class

$$c_1(L) = \sum_i q_i^3. \quad (8.9)$$

In particular, the $U(1)^3$ anomaly coefficient measures the failure to commute of the two translations $T_z: z \rightarrow z + 1$ and $T_y: y \rightarrow y + 1$.

More generally, if we look at multiple $U(1)$ flavor symmetries, with 4d chirals of charges $q_{i,a}$ under the a -th flavor symmetry, the coefficient of μ_c in the discontinuity of $B_{\mu_a} \equiv \partial_{\mu_a} \mathcal{W}|_{\text{vacuum}}$ under $\mu_b \rightarrow \mu_b + \tau$ equal to

$$- 2\pi i \sum_i q_{i,a} q_{i,b} q_{i,c}. \quad (8.10)$$

Thus any mixed anomaly between the $U(1)$ flavor symmetries will cause trouble with the periodicity of the tt^* geometry. We will encounter similar statements for non-Abelian flavor symmetries, by considering their Cartan subgroup.

For example, consider a theory of two 4d chirals. The theory has a non-anomalous “vector” flavor symmetry which rotates a chiral in one direction, and the other chiral in the opposite direction and an anomalous “axial” symmetry which rotates them in the same direction. If we do not turn on a Wilson line for the axial symmetry, the tt^* geometry for the vector symmetry is well defined, but trivial, as the contribution of the two chirals essentially cancels out. On the other hand, if we allow a generic fixed flavor Wilson line μ' for the “axial” flavor symmetry and study the tt^* geometry for the vector symmetry we still have some trouble, although less serious: the harmonic function V is not periodic, but it shifts by a constant (*i.e.* $e^{\partial_{\mu} W}|_{\text{vacuum}}$ is a section of a topologically trivial line bundle). Now the tt^* connection has a curvature $F = *dV$ which is strictly periodic, and hence well-defined (up to gauge transformations).

Correspondingly, the spectral curve

$$e^p = \frac{\Theta(\mu + \mu', \tau)}{\Theta(-\mu + \mu', \tau)} \quad (8.11)$$

is not a well-defined curve in $\mathbb{C}^* \times T^2$, as p is multi-valued by $4\pi i \mu'$. Unlike the case with a single chiral field, this spectral curve can still make sense as a curve in a non-trivial \mathbb{C}^* bundle over T^2 , and the tt^* monopole geometry can make sense if we think about the Higgs field as a periodic scalar field whose profile is a section of an affine bundle over T^3 .

To gain more insight into this case it is useful to consider the 5-brane construction of the last section associated with this geometry by viewing the 4d theories as probes of 6d (2,0) or (1,0) theories. As discussed in [62] the 5-brane geometries which are on a cylinder, instead of a plane, are equivalent to 6d theories. Moreover as noted in [63, 64, 72] the 6d theories can be viewed either as circle compactification of 6d gauge theories or (1,0) SCFT’s theories. For example consider the brane geometry given

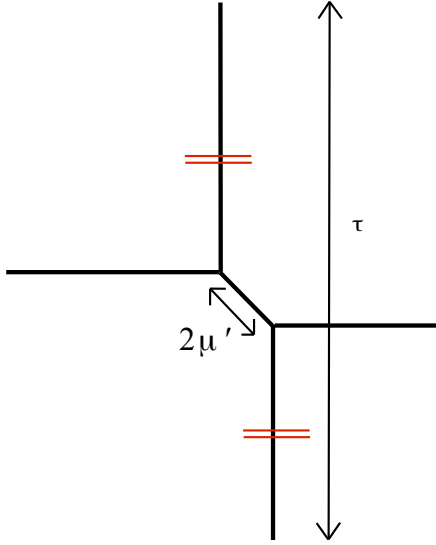

Figure 18: A Single M5 brane in the presence of a Taub-NUT, is dual, after compactification on a circle, to this 5-brane web diagram on a cylinder with circumference τ . The mass parameter $m = 2\mu'$ is induced from the R-twist around the compactified circle leading to $\mathcal{N} = 2^*$ theory in 5d with adjoint mass m .

by Fig. 18. This corresponds to an M5 brane geometry compactified on a circle with a twist around the circle corresponding to a mass $m = 2\mu'$, which in 5d becomes the $U(1)$, $\mathcal{N} = 2^*$ theory where μ' is the mass parameter for the adjoint field. Note that the plane geometry is twisted, in that as we go around the vertical direction, we shift along the horizontal direction by an amount μ' . Indeed, upon compactification on another circle, this gives rise to an $\mathcal{N} = 2$ theory in $d = 4$ with the Seiberg-Witten curve given by [62]

$$e^p \Theta(-x + \mu', \tau) - \Theta(x + \mu', \tau) = 0$$

where this is an equation for x and p .

The 4d probe of M5 brane, upon compactification on a circle, corresponds to 3d theories corresponding to the suspended branes, where the suspended brane ends on the web at $x = \mu$. This gives rise to a theory with two chiral fields of masses $\mu + \mu'$ and $-\mu + \mu'$. See Fig. 19.

In fact this geometry gives rise to the spectral curve eq.(8.11), and this is because the brane probe theory supports two chiral fields (reflected in this case by the two 1-branes stretched between the web and the D3 brane). The fact that the μ parameter is periodic (while in the 3d case it took values in \mathbb{R}) is simply a reflection of the fact that the vertical direction is periodic, and as the spectator goes around

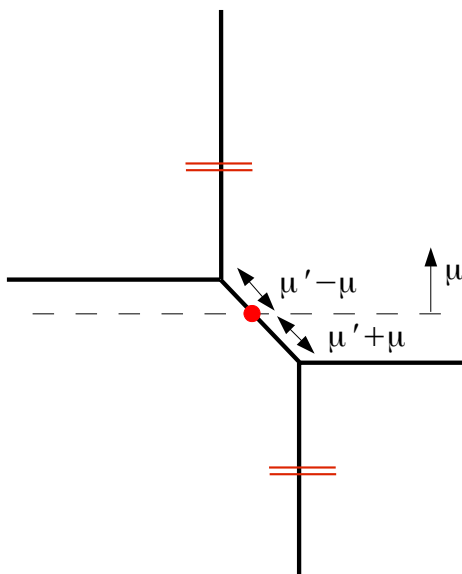

Figure 19: This web diagram is dual to 4d theory with two chiral fields of masses $\mu' + \mu$ and $\mu' - \mu$. The variable μ which changes with the position of the spectator brane is a periodic variable.

the vertical direction by τ it comes back to the original position, thus giving a parameter space T^3 . The lack of periodicity of the Higgs field, *i.e.* the shift in the horizontal direction as we go around the vertical direction, will give rise to a generalized tt^* geometry which as discussed in section 3 corresponds to the Nahm transform of hyperholomorphic connections on a non-commutative space. Moreover as found for this model in eq.(3.89) the non-commutativity parameter is proportional to μ' . The non-commutativity would disappear, and we get the ordinary tt^* commutative geometry, if we set $\mu' = 0$ and avoid turning on Wilson lines for anomalous flavor symmetries. We can also consider more chiral fields which corresponds to a 4d probe of the $(1, 0)$ theory given by an M5 brane probing an A_{n-1} singularity. See Fig. 20. If we use n chirals of charge 1, n of charge -1 we get a spectral curve:

$$e^p = \prod_a \frac{\Theta(\mu - \mu_a, \tau)}{\Theta(-\mu + \mu'_a, \tau)} \quad (8.12)$$

Again, if we want to avoid the anomalous flavor symmetry we can turn off the axial flavor Wilson lines and set $\sum_a \mu_a - \sum_a \mu'_a = 0$. Without loss of generality we can set $\sum_a \mu_a = \sum_a \mu'_a = 0$ by shifting μ if necessary. This is a sensible spectral curve, and corresponds to a triply-periodic collection of $U(1)$ Dirac monopoles n of charge 1 and n of charge -1 , at positions $\vec{\theta}_a$ and $\vec{\theta}'_a$ on T^3 constrained to satisfy $\sum_a \vec{\theta}_a = \sum_a \vec{\theta}'_a = 0$.

The obvious next step is to gauge the $U(1)$ flavor symmetry, to get $\mathcal{N} = 1$ SQED with n flavors. Although the theory has a Landau pole, the tt^* geometry is oblivious

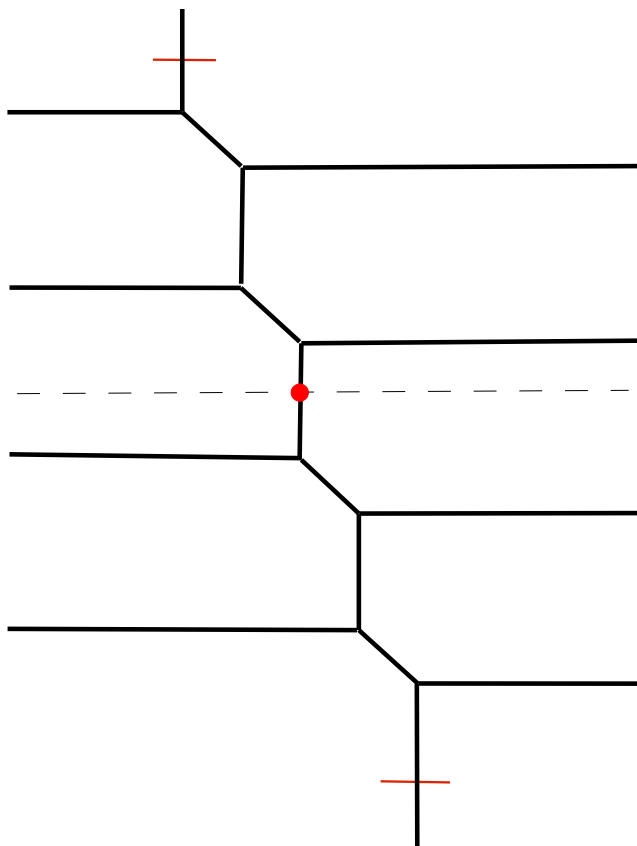

Figure 20: This web diagram includes a 4d subsector with $2n = 8$ chiral fields of charges $(+1^4, -1^4)$ under the $U(1)$ flavor symmetry.

to the 4d gauge coupling, and should thus be relatively well-defined. As this is simply a Nahm transform of the previous problem, the spectral curve is

$$e^t = \prod_a \frac{\Theta(\sigma - \mu_a, \tau)}{\Theta(-\sigma + \mu'_a, \tau)} \quad (8.13)$$

where t is the (complexified) FI parameter. We can better write the equation as

$$e^t \prod_a \Theta(-\sigma + \mu'_a, \tau) - \prod_a \Theta(\sigma - \mu_a, \tau) = 0 \quad (8.14)$$

This equation is a degree n theta function on the torus, and has n zeroes σ_i^* , which represent the gauge Wilson lines in the n vacua of the theory compactified on T^2 . In terms of brane diagrams, the spectator brane is now oriented vertically. See Fig. 21.

Geometrically, the tt^* geometry is a triply-periodic instanton geometry, *i.e.* an instanton in $\mathbb{R}_t \times T^3$. The complexified FI parameter t is a coordinate on $\mathbb{R}_t \times S^1$, while by definition the zeroes σ_i^* characterize the holomorphic $SU(n)$ bundle on the

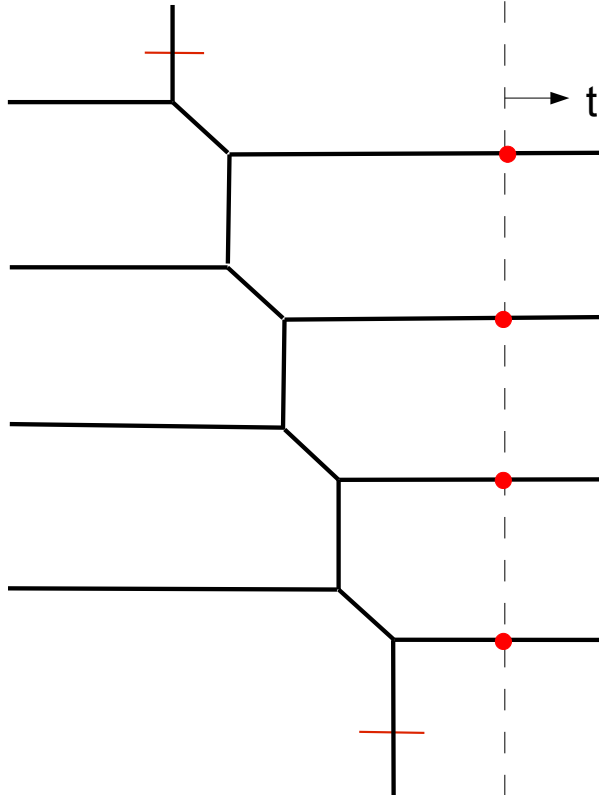

Figure 21: This web diagram together with the probe engineers SQCD with 4 flavors. The theory has 4 vacua. The FI parameter of the $U(1)$ theory is controlled by t , the position of the spectator brane. The rank of the group depends on how many branes we suspend between the spectator brane and the web. For $U(n_c)$ we need n_c suspended branes.

remaining T^2 directions. Thus the μ'_a and μ_a parameters label the holomorphic $SU(n)$ bundle at large positive and large negative t respectively. This instanton solution appears to be rigid. The spectral curve, for example, has no moduli.

8.1 SQCD

Much as it happens for the Grassmanian GLSM [7] (see also the review in [14]), the twisted chiral ring relations for an $U(n_c)$ four-dimensional gauge theory with n_f flavors are closely related to the ones for a $U(1)$ theory, and can be engineered as in the case of $U(1)$ SQED discussed above, by taking n_c suspended D-branes. In this case each of the Wilson lines σ_i in the Cartan of $U(n_c)$ must solve

$$e^t \prod_a \Theta(-\sigma_i + \mu'_a, \tau) - \prod_a \Theta(\sigma_i - \mu_a, \tau) = 0 \quad (8.15)$$

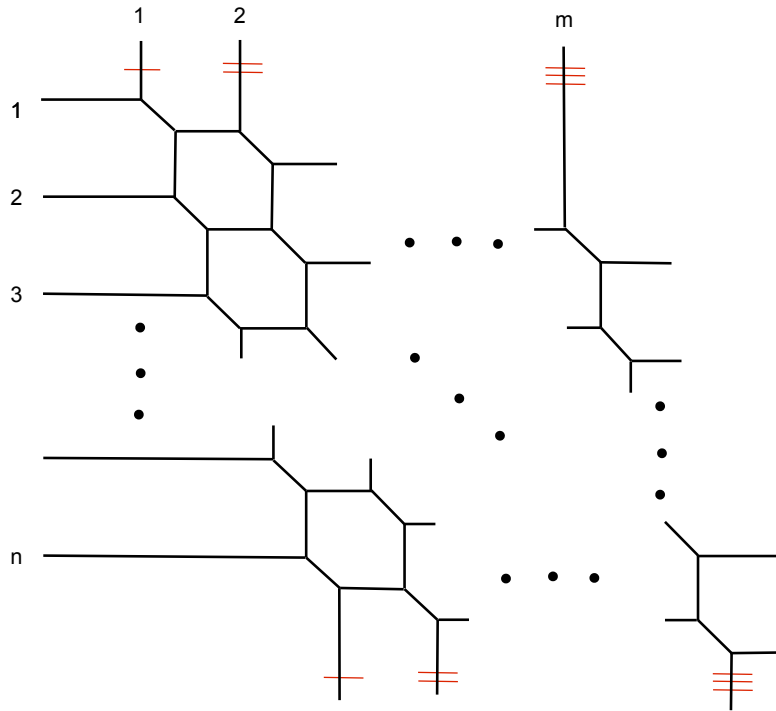

Figure 22: This web diagram is a circle compactification of the 6d (1,0) SCFT of m M5 branes in the presence of A_{n-1} singularity.

with the extra constraints that they should be distinct solutions.

Thus the $\binom{n_f}{n_c}$ vacua of the system coincide with the possible choices of n_c distinct roots of the above degree n_f theta function.²⁷ It is pretty clear that the tt^* geometry should thus be the rank $\binom{n_f}{n_c}$ triply-periodic instanton obtained as the n_c -th exterior power of the rank n_f bundle described above.

In order to describe the tt^* geometry for the true SQCD theory, *i.e.* a $SU(n_c)$ gauge theory with n_f flavors, we need to “ungauge” the diagonal $U(1)$ gauge symmetry, *i.e.* do a Nahm transform of the rank $\binom{n_f}{n_c}$ triply-periodic instanton to some triply-periodic monopole geometry for the vector $U(1)$ flavor symmetry.

8.2 4d probes of more general 6d (1,0) SCFT’s

It is natural to consider more general singly periodic web diagrams. See Fig. 22. In this case we have n horizontal directions on the web broken by m vertical directions. This 5d theory corresponds to compactifications of the 6d (1,0) SCFT, given by m parallel M5 branes probing an A_{n-1} singularity, on a circle [64, 72]. The distance between the vertical lines relate to the separation of M5 branes. Taking the spectator

²⁷ The remaining $n - n_c$ roots are nothing else but the Wilson lines of the Seiberg-dual gauge group.

5-brane in the vertical direction and suspending a D3 brane, gives rise in 6d, to a 4d theory with $\mathcal{N} = 1$. The corresponding theory will have n vacua, giving rise to tt^* geometry of $SU(n)$ instantons on $\mathbb{R} \times T^3$ with instanton number m . The corresponding spectral curve would be given by

$$\sum_{k=0}^m a_k e^{kt} \prod_{a=1}^n \Theta(-\sigma + \mu_a^k, \tau) = 0, \quad (8.16)$$

which gives us a more-general $SU(n)$ instanton geometry on $\mathbb{R}_t \times T^3$, with boundary conditions at large $|t|$ still controlled by the μ_a^0 and μ_a^n parameters.²⁸

Strictly speaking, it is not obvious that the $U(1)$ gauge group associated to the FI parameter t will survive the field-theory limit. It is more-likely that a well-defined co-dimension two defect in the $(1, 0)$ 6d theories would support an $U(1)$ flavor symmetry in its world volume, and that the triply-periodic instanton tt^* geometry is the result of gauging that $U(1)$ flavor symmetry. In order to describe the tt^* geometry of the original defect, we should do a Nahm transform back to a triply-periodic monopole geometry, and re-interpret the spectral curve

$$\sum_{k=0}^m a_k e^{kp} \prod_{a=1}^n \Theta(-\sigma + \mu_a^k, \tau) = 0 \quad (8.17)$$

as the spectral curve for a $U(N)$ triply-periodic monopole solution on T_m^3 , in the presence of n Dirac monopoles of charge 1 and n of charge -1 .

It is also natural to ask if we can get instantons on T^4 , by having a ‘periodic’ version of FI parameter t . This is indeed possible, because we can consider the doubly periodic brane geometry, *i.e.* 5-branes not on a cylinder but on a T^2 . See Fig. 23.

As noted in [63] this geometry will engineer the little string theories. More specifically this corresponds to m M5-branes probing an A_{n-1} singularity where one transverse dimension to the M5 branes has been compactified on the circle. This would then lead to the parameter space being T^4 and the tt^* geometry would correspond to $SU(n)$ instantons of instanton number m on T^4 .²⁹ The corresponding spectral curves will involve level (n, m) genus 2 Θ functions as discussed in [62].

As already discussed, to obtain the conventional tt^* geometry we had to turn off anomalous flavor Wilson lines. Moreover we have argued that when we turn them on the tt^* geometry becomes non-commutative. Given the unusual nature of this result it is interesting to note that we can get a confirmation of our results from a

²⁸ The $(n-1)m + (m+1) - 1 = nm$ complex normalizable moduli coming from the choices of the other μ_a^i , the a_k , and getting rid of one overall normalization for the equation, combine with the moduli of the line bundle over the spectral curve to give a moduli space of solutions of hyperKähler dimension mn .

²⁹Exchanging the vertical and the horizontal direction will map this to $SU(m)$ instantons of instanton number n , which is an instance of Fourier-Mukai/Nahm transformation.

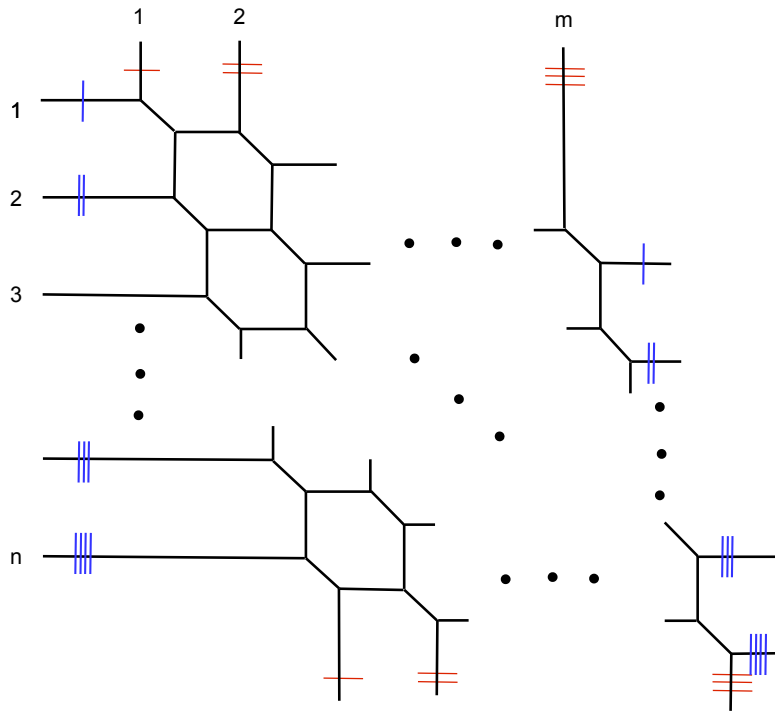

Figure 23: This web diagram is a circle compactification of the little 6d string theory of m M5 branes in the presence of A_{n-1} singularity with one transverse circular geometry. Adding a spectator brane and a probe to this geometry realizes the tt^* geometry associated to $SU(n)$ instantons with instanton number m on (non-commutative) T^4 .

different perspective from the elegant work [73, 74]. In particular they show that the moduli space of non-commutative instantons on T^4 is given by the moduli space of the $(1, 0)$ superconformal theories we have discussed. Moreover they show that the spectral curve for such instantons are precisely the associated Seiberg-Witten curves. The non-commutativity is mapped to horizontal and vertical shifts as we go around the cycles of the plane of the 5-branes. This agrees with what we expected in that when we have 4d flavor symmetries which would have anomalies (if gauged) we get non-commutative versions of tt^* geometry. Note that in these contexts the value of non-commutative parameters are not part of the moduli space of the tt^* geometry. They are fixed background values. Moreover turning on the angular parts of the mass parameters, we expect to get 3 non-commutativity parameter for each periodic direction of the 5brane plane in agreement with the results of [73, 74].

There is a further modification of this setup, which is worth mentioning. On the periodic fivebrane web picture, it corresponds to having the bundles of semi-infinite fivebranes end on groups of D7 branes, as in [81].

Alternatively, if we T-dualize to a system of D6 branes crossing NS5 branes

[80], we can consider the full Hanany-Zaffaroni setup which includes $D8$ branes, to describe a somewhat larger class of $(1,0)$ theories which can be interpreted, as in lower dimensional cases, as “Higgs branch descendants” of the 6d theories described above, *i.e.* sit at the bottom of an RG flow initiated by turning on some special Higgs branch vevs. The spectral curve is a slight generalization of the above:

$$\begin{aligned}
& e^{(N+1)\tau} \prod_a \Theta(-\sigma + \mu'_a, \tau)^{n'_a} + \\
& \sum_{k=1}^N e^{(N+1-k)\tau} \prod_a \Theta(-\sigma + \mu'_a, \tau)^{\max(n'_a-k, 0)} \Theta(\sigma - \mu_a, \tau)^{\max(n_a+k-N-1, 0)} \Theta_n^{(k)}(\sigma, \tau) + \\
& \prod_a \Theta(\sigma - \mu_a, \tau)^{n_a} = 0
\end{aligned} \tag{8.18}$$

which is constructed in such a way to describe $U(N)$ triply-periodic monopole solution on T_m^3 , in the presence of Dirac monopoles of charge n_a and $-n'_a$.

9 Line operators and the CFIV index

The tt^* geometry in 2 dimensions led, in particular, to the calculation of a new supersymmetric index, the CFIV index [23], given by³⁰

$$Q_{ab} = \lim_{L \rightarrow \infty} \frac{i\beta}{2L} \text{Tr}_{ab} (-1)^F F e^{-\beta H} \tag{9.1}$$

where the space is taken to be a segment of length L with boundary conditions a, b at the two ends, and we take the infinite volume limit $L \rightarrow \infty$. Q_{ab} can be identified with the tt^* connection in the direction of RG flow, in a suitable gauge.

Q_{ab} is an index in the sense that it depends only on a finite number of parameters in the theory (F-terms) and is insensitive to all the others. In the limit $\beta \rightarrow \infty$ it becomes an index in the ordinary sense, which counts the net number of short supersymmetry representations in the Hilbert space sector specified by the boundary conditions a, b . Furthermore, one can exchange space and Euclidean time and relate Q_{ab} to the expectation value of the axial R-symmetry charge Q^5 (using the 2d fact that $j_\mu^5 = *j_\mu^F$), which is broken away from the conformal point:

$$Q_{ab} = \frac{1}{2} \langle a | Q^5 | b \rangle.$$

³⁰ The peculiar overall factor $1/2$ in the RHS is an artifact of the choices of normalization of the charges. The Fermi number F is normalized in such a way that the supercharges have Fermi number ± 1 . Then the odd superspace coordinates θ also have charges ± 1 . Instead the Q_{ab} is normalized in such a way that, at criticality, the difference between its maximal and minimal eigenvalues is \hat{c} . Effectively, this is the same as assigning axial charge 1 to the superpotential W , and hence charges $\pm 1/2$ to the θ 's. Therefore Q_{ab} is $1/2$ the CFIV index.

This can be interpreted as the action of the operator

$$Q^5 = \int_{S^1_\beta} \left(j_\beta^F + Q\text{-exact} \right)$$

on the ground states:

$$Q_{ab} = \frac{1}{2} \left\langle a \left| \oint_{S^1_\beta} j_\beta^F \right| b \right\rangle \quad (9.2)$$

where by j_β^F we mean the component of the Fermion number R-current j^F in the direction of S^1_β . At the conformal point, this corresponds to the spectrum of the R-charges of the Ramond ground states, which by spectral flow, gives the spectrum of chiral operators in the theory. Twice the highest eigenvalue of Q^5 corresponds to \hat{c} , the central charge of the $\mathcal{N} = 2$ theory. Away from the conformal point, even though Q^5 is no longer conserved, one can still compute its spectrum restricted to the ground states, and it was shown [23] that the entire spectrum of Q_{ij} is monotonically decreasing as we flow to the infrared. Applied to the highest eigenvalue of Q^5 as one flows from one fixed point to another, this leads to the statement that along RG flow \hat{c} decreases.

It is natural to ask what are the physical implications of the CFIV index, applied to theories which arise from 3 or 4 dimensions. In this section we take some preliminary steps in this direction trying to find the physical meaning of this quantity. Moreover we compute it explicitly for the case of free chiral fields in 3 dimensions with a twisted mass.

9.1 CFIV index and 3d theories

Consider a 3d theory, compactified on a rectangular torus with periods R, β . We can view this as a 2d theory on a spatial circle of length β , by viewing the 3d fields as an infinite tower of KK modes arising from compactification on a circle of length R . The conserved 2d R-symmetry which corresponds to the fermion number F will lift in the 3d context to the conserved 3d R-symmetry which is present for all 3d theories with $\mathcal{N} = 2$. We can thus interpret the expression (9.1) as computing the same quantity, except that the space is now two dimensional, comprising of $\mathbb{R}^1 \times S^1$, where the length of \mathbb{R}^1 is taken to be L and we take $L \rightarrow \infty$, and the length of S^1 is R . Moreover the answer can now depend on x_i, y_i , where the y_i 's correspond to the imaginary part of the 2d coupling parameters, and x_i 's can be viewed as an additional insertion of flavor fugacities around the β circle:

$$Q_{ab}(x_i, y_i, m_i, \rho) = \lim_{L \rightarrow \infty} \frac{i\beta}{2L} \text{Tr}_{ab} \left[(-1)^F F e^{-\beta H + 2\pi i x_i f_i} \right] \quad (9.3)$$

where we have separated out the imaginary piece y_i from the real part m_i of the twisted mass parameters, and set $\rho = \beta/R = -i\tau$; f_i denote the i -th flavor charge.

We will compute this quantity for the case of the 3d free chiral model and verify this Hilbert space interpretation.

Moreover, we can also look at this quantity from the perspective of the dual channel. Namely we can consider the Hilbert space of the 3d theory on a T^2 with periods (β, R) and flavor Wilson lines (x_i, y_i) around the two cycles. In this context we have

$$2Q_{ab}(x_i, y_i, \mu_i, \rho) = \left\langle a \left| \oint_{S^1_\beta} \oint_{S^1_R} j_\beta^F \right| b \right\rangle_{(\beta x_i, R y_i)} \equiv \beta R \langle a | j_\beta^F | b \rangle_{(\beta x_i, R y_i)}. \quad (9.4)$$

Of course, by interchanging the role of the two circles, the CFIV index also computes the vacuum matrix elements of the other component of the current j_R^F (the third component, j_L^F , has vanishing matrix elements between vacua).

9.2 Possible interpretations of Q in terms of line operators

In the case of 2d, at the conformal fixed point the (differences) in the spectrum of Q determine the dimension of chiral fields. In particular in that case we have

$$\Phi_i(0)\bar{\Phi}_i(z) \sim \frac{A}{|z|^{2Q_i}}, \quad z \sim 0,$$

where Q_i denote the charge of the chiral field Φ_i , and A can be read from the $\beta \rightarrow 0$ behavior of the tt^* metric [1]. It is natural to ask if a similar statement holds for the case of 3d theories at their conformal limit where $m_i = 0$. In this case, as already mentioned, the chiral fields are replaced by line operators, and so the question would be: How the partition function of the theory depends on separation $|z|$ of a line operator and its conjugate?

Consider the line operators wrapping the S^1_R . From another perspective, this can be interpreted as a particle defect. A natural question in this context would be how the energy of the system depends on the separation between a line operator and its conjugate, *i.e.* the Casimir energy of line operator/ anti-line operator system. If Q is related to such an energy, as we increase $R \rightarrow \infty$ for a fixed β , *i.e.* as we take $\rho \rightarrow 0$, Q should grow linearly in R since the energy $E(R, |z|)$ should be proportional to the spatial size R of the system, up to finite size corrections. So we would expect Q/R to have a finite limit as $R \rightarrow \infty$. As we shall see in the explicit example below, this is indeed the case. It would be interesting to see if Q/R in this limit is related to the Casimir energy of pairs of conjugate line operators. It would also be interesting to connect the conformal limit of this computation to the cusp anomalous dimension for line operators (see e.g. [82]).

9.3 On the CFIV index for the 3d chiral model

We consider the free chiral model in 3d with twisted mass m which upon reduction on a circle of radius R is equivalent to the 2d (2,2) LG model (6.2) with

$$W(Y_n) = \sum_{n \in \mathbb{Z}} \left(\frac{1}{2} \left(\frac{m}{2\pi} + i \frac{n+y}{R} \right) Y_n - e^{Y_n} \right).$$

We further consider putting the theory on a tt^* circle of length β . We set $\rho = \beta/R = -i\tau$. We write x for the vacuum angle with period 1, y for the second angle (also with period 1) associated with the imaginary part of the 2d twisted mass, and set $z = \beta m/2\pi$; then the 3d real mass (made dimensionless by multiplying it by β) is $2\pi z$.

The CFIV index for this model is the sum over the KK modes of the CFIV index for the 2d single-mode theory. In appendix A.3 we present several convenient expressions of this last index. From, say, eqn.(A.35) we have

$$\begin{aligned} Q(x, y, z, \rho) &= \\ &= -\frac{1}{\pi} \sum_{n \in \mathbb{Z}} \sum_{k \geq 1} \frac{\sin(2\pi k x)}{k} \left(2\pi k |z + i(y+n)\rho| \right) K_1 \left(2\pi k |z + i(y+n)\rho| \right). \end{aligned} \quad (9.5)$$

See eqn.(9.24) below for the Poisson-resummed expression of $Q(x, y, z, \rho)$ as a double Fourier series in the two periodic variables x, y .

$Q(x, y, z, \rho)$ has two interesting limits. One is $R \rightarrow 0$ at β fixed, that is, $\rho \rightarrow \infty$, while keeping $y\rho$ fixed. In this case all terms in the sum over the KK modes n , except for the zero mode $n = 0$, vanish exponentially, and we get back the 2d expression with complex twisted mass $m + 2\pi i y/R$.

The second one is the opposite limit $R \rightarrow \infty$. Before computing it, let us list the physical properties we expect the answer to have.

Physical expectations as $R \rightarrow \infty$. The tt^* amplitudes in this limit are correlators of line operators wrapped on a cycle of large length R . Since the CFIV index is believed to give the values of some kind of *extensive* quantity, like the Casimir energy of the vacuum states on T^2 created by the line operators, we expect that, asymptotically for large R and fixed β , Q becomes proportional to R

$$Q(x, y, z, \beta/R) \Big|_{R \rightarrow \infty} = \frac{R}{\beta} \cdot f(x, y, z) + \text{finite-size corrections}, \quad (9.6)$$

where $f(x, y, z)/\beta$ is the *finite* linear density of the said extensive quantity, which should scale with the temperature β^{-1} by dimensional considerations. We also expect the function $f(x, y, z)$ to be y -independent, since a finite flavor twist over a circle of infinite length should not affect the value of the local density of an extensive quantity.

Moreover, as a function of x , $f(x, y, z)$ should be periodic of period 1 and odd (this last condition reflects consistency with CPT). Finally, since the mass of the physical particle in 3d is $2\pi|z|/\beta$, and the CFIV index is a Hilbert space trace of the form (9.3), for *large* values of the mass $m = 2\pi|z|/\beta$ the density Q/R should have the standard thermodynamical expression

$$\begin{aligned} \frac{1}{\beta} f(x, y, z) &\sim \frac{i\beta}{2} \left(e^{2\pi ix} - e^{-2\pi ix} \right) \int \frac{d^2 p}{(2\pi)^2} e^{-\beta\sqrt{p^2+m^2}} = \\ &= \frac{i}{4\pi} \left(e^{2\pi ix} - e^{-2\pi ix} \right) \left(\frac{1}{\beta} + m \right) e^{-\beta m}, \end{aligned} \quad (9.7)$$

where the factors $e^{\pm 2\pi ix}$ arise from the role of $e^{2\pi ix}$ as particle number fugacity, and their relative combination is fixed by PCT and reality of $f(x, y, z)$. In fact, the RHS turns out to be the *exact* expression of the terms proportional to $e^{\pm 2\pi ix}$ in the Fourier expansion of $f(x, y, z)$. This means that multiparticle states of total flavor charge ± 1 do not contribute to Q . This last statement is exact for all R , not just for R large. Indeed, the term proportional to $e^{2\pi ix}$ in eqn.(9.5) is

$$\begin{aligned} \frac{i\beta}{2\pi} e^{2\pi ix} \sum_{n \in \mathbb{Z}} \left(|m + 2\pi i(y + n)/R| \right) K_1 \left(\beta |m + 2\pi i(y + n)/R| \right) &\equiv \\ &\equiv \frac{i\beta}{2} e^{2\pi ix} \sum_{n \in \mathbb{Z}_{-\infty}^{+\infty}} \int \frac{dp}{2\pi} e^{-\beta\sqrt{p^2 + (2\pi)^2(n+y)^2/R^2 + m^2}}, \end{aligned} \quad (9.8)$$

which is the partition function of a particle of mass m in an infinite cylinder of circumference R and holonomy $\exp(2\pi iy)$.

More generally, given that this theory has only one physically distinct vacuum, we may think of computing the trace in eqn.(9.1) by inserting a complete set of intermediate states, which may be taken to be free particle states; this implies that the coefficient of $e^{2\pi ikx}$ in the Fourier expansion of Q (and hence of f) should be $O(e^{-\beta|k||m|})$ for large $|m|$. Again, this is manifestly true for the expression (9.5).

The function $f(x, y, z)$. Before showing that these expectations are correct, and giving an explicit formula for $f(x, y, z)$, we rewrite the expression (9.5) in a more compact and illuminating form. We start from the following integral representation of $K_1(w)$

$$K_1(w) = \frac{1}{w} \int_0^\infty dt e^{-t-w^2/4t} \quad |\arg w| < \pi/4. \quad (9.9)$$

Plugging this formula into (9.5) we get

$$Q(x, y, z, \rho) = -\frac{1}{\pi} \sum_{k \geq 1} \frac{\sin(2\pi kx)}{k} \int_0^\infty dt e^{-t} \left(\sum_{n \in \mathbb{Z}} e^{-4\pi^2 k^2 (z^2 + (y+n)^2 \rho^2)/4t} \right). \quad (9.10)$$

The expression inside the big parenthesis is a θ_3 function. To get a rapidly convergent expression for ρ small we have just to express this function in terms of the θ -function for the inverse period using its modular transformation properties. More precisely, we have

$$\begin{aligned} \sum_{n \in \mathbb{Z}} e^{-4\pi^2 k^2 (z^2 + (y+n)^2 \rho^2) / 4t} &= e^{-\pi^2 k^2 (z^2 + y^2 \rho^2) / t} \sum_{n \in \mathbb{Z}} \left(e^{-2\pi^2 k^2 \rho^2 / t} \right)^{n^2/2} \left(e^{-2\pi^2 k^2 \rho^2 y / t} \right)^n = \\ &= e^{-\pi^2 k^2 (z^2 + y^2 \rho^2) / t} \theta_3 \left(i\pi^2 k^2 \rho^2 y / t \mid i\pi k^2 \rho^2 / t \right), \end{aligned} \quad (9.11)$$

where

$$\theta_3(w \mid \sigma) = \sum_{n \in \mathbb{Z}} q^{n^2/2} e^{2inw}, \quad q = e^{2\pi i \sigma}. \quad (9.12)$$

Thus

$$\begin{aligned} Q(x, y, z, \rho) &= \\ &= -\frac{1}{\pi} \sum_{k \geq 1} \frac{\sin(2\pi kx)}{k} \int_0^\infty dt e^{-t} e^{-\pi^2 k^2 (z^2 + y^2 \rho^2) / t} \theta_3 \left(i\pi^2 k^2 \rho^2 y / t \mid i\pi k^2 \rho^2 / t \right). \end{aligned} \quad (9.13)$$

The simplest way to compute the $\rho \rightarrow 0$ (*i.e.* the $R \rightarrow \infty$) limit is to replace the theta function by its S -modular transform

$$\theta_3(w \mid \sigma) = (-i\sigma)^{-1/2} \exp(-iw^2/\pi\sigma) \theta_3(-w/\sigma \mid -1/\sigma), \quad (9.14)$$

which gives

$$\begin{aligned} Q(x, y, z, \rho) &= \\ &= -\frac{1}{(\pi)^{3/2} \rho} \sum_{k \geq 1} \frac{\sin(2\pi kx)}{k^2} \int_0^\infty dt \sqrt{t} e^{-t - \pi^2 k^2 z^2 / t} \theta_3 \left(-\pi y \mid \frac{it}{\pi k^2 \rho^2} \right). \end{aligned} \quad (9.15)$$

The function $f(x, y, z)$ is defined by taking first the infinite size limit $R \rightarrow \infty$ at fixed x, y, z . In the limit $\rho \rightarrow 0$ ($R \rightarrow \infty$) the theta function in the integrand of (9.15) may be replaced by its asymptotic expression, which is just 1. Thus, since $\rho = \beta/R$, for large R

$$Q(x, y, z, \beta/R) \approx -\frac{R}{(\pi)^{3/2} \beta} \sum_{k \geq 1} \frac{\sin(2\pi kx)}{k^2} \int_0^\infty dt \sqrt{t} e^{-t - \pi^2 k^2 z^2 / t}, \quad (9.16)$$

Now,

$$\int_0^\infty \exp\left(-t - \frac{w^2}{4t}\right) \sqrt{t} dt = \frac{1}{\sqrt{2}} w^{3/2} K_{3/2}(w) \equiv \frac{\sqrt{\pi}}{2} e^{-w} (1+w) \quad (9.17)$$

and

$$Q(x, y, z, \beta/R) \approx -\frac{R}{\beta} \frac{1}{2\pi} \sum_{k \geq 1} \frac{\sin(2\pi kx)}{k^2} e^{-2\pi k|z|} \left(1 + 2\pi k|z|\right), \quad (9.18)$$

which is of the expected form with

$$f(x, y, z) = \frac{1}{4\pi i} \left(\text{Li}_2(e^{-2\pi(|z|+ix)}) - \text{Li}_2(e^{-2\pi(|z|-ix)}) \right) + \frac{|z|}{2i} \left[\log(1 - e^{-2\pi(|z|-ix)}) - \log(1 - e^{-2\pi(|z|+ix)}) \right]. \quad (9.19)$$

This expression exactly matches the physical predictions (9.7). In particular, $f(x, y, z)$ is independent of y , periodic and odd in x , and has a leading behavior for large $|m|$ as expected, eqn.(9.7). As already mentioned, the coefficient of $e^{\pm 2\pi i x}$ in the Fourier expansion of $f(x, y, z)$ are exactly given by eqn.(9.7).

In particular, at $z = 0$ we have

$$f(x, y, 0) = -\frac{1}{2\pi} \Pi(x), \quad (9.20)$$

where $\Pi(x)$ is the Lobachevsky function (a.k.a. the Clausen integral), which expresses *inter alia* the volume of the ideal tetrahedra in hyperbolic 3-space. One has

$$\Pi(x) = \sum_{m \geq 1} \frac{\sin(2\pi mx)}{m^2} = \frac{\text{Li}_2(e^{2\pi i x}) - \text{Li}_2(e^{-2\pi i x})}{2i} = -\int_0^{2\pi x} \log\left(2 \sin(s/2)\right) ds. \quad (9.21)$$

The double Fourier series for Q . We can write alternative expressions for the 3d chiral CFIV index which are more convenient for computing sub-leading corrections to the large R behaviour (9.18). We start from eqn.(9.15)

$$\begin{aligned} Q(x, y, z, \rho) &= \\ &= -\frac{1}{(\pi)^{3/2} \rho} \sum_{k \geq 1} \frac{\sin(2\pi kx)}{k^2} \int_0^\infty dt \sqrt{t} e^{-t - \pi^2 k^2 z^2 / t} \theta_3\left(-\pi y \mid \frac{it}{\pi k^2 \rho^2}\right) = \\ &= -\frac{1}{(\pi)^{3/2} \rho} \sum_{k \geq 1} \frac{\sin(2\pi kx)}{k^2} \int_0^\infty dt \sqrt{t} e^{-t - \pi^2 k^2 z^2 / t} \sum_{n \in \mathbb{Z}} e^{-tn^2/k^2 \rho^2} e^{-2\pi i n y}. \end{aligned} \quad (9.22)$$

The integral in t may be computed using

$$\int_0^\infty dt \sqrt{t} e^{-at - b/t} = \frac{\sqrt{\pi}}{2a^{3/2}} (1 + 2\sqrt{ab}) e^{-2\sqrt{ab}} \quad \text{Re } a, \text{ Re } b > 0. \quad (9.23)$$

This allows us to rewrite the CFIV index explicitly as a double Fourier series in x and y :

$$Q(x, y, z, \rho) = \frac{1}{\rho} f(x, 0, z) - \frac{\rho}{\pi} \sum_{\substack{k \geq 1 \\ n \geq 1}} \frac{k \sin(2\pi kx) \cos(2\pi ny)}{(n^2 + k^2 \rho^2)^{3/2}} [\rho + 2\pi|z| \sqrt{k^2 \rho^2 + n^2}] \times \\ \times \exp\left(-2\pi|z| \sqrt{n^2/\rho^2 + k^2}\right), \quad (9.24)$$

which, of course, matches with the result one would obtain starting with the known double Fourier series for the tt^* metric of the 3d chiral field.

Finite-size corrections. The first term in the RHS of the exact equation (9.24) is the previous asymptotic behavior as $\rho \rightarrow 0$ (keeping fixed $2\pi|z|/\rho \equiv |m|R$). One may go on and compute the corrections in powers of ρ^2 . The first correction is $O(\rho^2)$

$$Q - \frac{1}{\rho} f(x, y, z) = -\frac{\rho^2}{2\pi} \left[\text{Li}_3(e^{-|m|R+2\pi y}) + \text{Li}_3(e^{-|m|R-2\pi y}) + \right. \\ \left. + |m|R \text{Li}_2(e^{-|m|R+2\pi y}) + |m|R \text{Li}_2(e^{-|m|R-2\pi y}) \right] + O(\rho^4). \quad (9.25)$$

9.4 General 3d $\mathcal{N} = 2$ models: large mass asymptotics

From the previous physical discussion, we expect that the limit

$$\lim_{R \rightarrow \infty} \frac{1}{R} Q(R) \quad (9.26)$$

exists for all 3d $\mathcal{N} = 2$ models compactified to 2d on a circle of length R . This will correspond to the energy per unit length of the system described at the beginning of the section. This fact may be checked explicitly for large twisted masses/FI parameters. Indeed, in this limit the tt^* equations linearize (this being just the statement that a non-Abelian monopole looks Abelian far away from its sources) and we get

$$Q_{ab} \approx \frac{iR}{2} \left(\Delta_{ab} \int \frac{d^2 p}{(2\pi)^2} e^{-\beta \sqrt{p^2 + m_{ab}^2}} + \right. \\ \left. + \sum_{\substack{\mathbf{k} \in \mathbb{Z}^r \\ \text{primitive}}} \Delta(\mathbf{k})_{ab} e^{2\pi i \mathbf{k} \cdot \mathbf{x}} \int \frac{d^2 p}{(2\pi)^2} e^{-\beta \sqrt{p^2 + m_{ab}(\mathbf{k})^2}} + \right. \\ \left. + \sum_{\ell \geq 2} \sum_{\substack{\mathbf{k} \in \mathbb{Z}^r \\ \text{primitive}}} c(\ell, \mathbf{k}) e^{-\ell \beta m_{ab}(\mathbf{k})} e^{2\pi i \ell \mathbf{k} \cdot \mathbf{x}} + \text{sub-leading} \right) \quad (9.27)$$

where $\mathbf{x} = (x_1, \dots, x_r)$ are the flavor chemical potentials, $m_{ab}(\mathbf{k})$ (resp. m_{ab}) is the mass of the lightest particle in the 3d Hilbert space sector \mathcal{H}_{ab} having flavor charges \mathbf{k} (resp. being flavor neutral); the coefficients $c(\ell, \mathbf{k})$ are polynomially bounded in

terms of the masses, and hence the terms in the last line are to be thought of as ‘subleading’. The coefficients Δ_{ab} and $\Delta(\mathbf{k})_{ab}$ are integers which satisfy the PCT conditions

$$\Delta_{ba} = -\Delta_{ab}, \quad \Delta(\mathbf{k})_{ba} = -\Delta(-\mathbf{k})_{ab}, \quad (9.28)$$

and count the net multiplicities, in the sense of the CFIV susy index, of 3d BPS particles having the corresponding quantum numbers. Note that the sum in eqn.(9.27) is over the primitive flavor charge vectors only. In writing the above equation we made use of a genericity assumption, namely that there are no accidental alignments in the 2d effective central charge complex plane.

The bottom line is that we may read the 3d BPS spectrum of a $\mathcal{N} = 2$ theory from the asymptotical behavior at infinity of the associated (higher dimensional) tt^* monopole fields. In turn this spectrum may be related, through the CFIV index, with the scaling behavior with the separation Δ of an extensive energy-like quantity associated with a configuration of two parallel line operators placed at the distance Δ .

Acknowledgements

We would like to thank M. Aganagic, U. Bruzzo, C. Cordova, T. Dimofte, B. Dubrovin, T. Dumitrescu, J. Gomis, S. Gukov, B. Haghighat, J. Heckman, D. Jafferis, J. Maldacena, S. Sachdev, M. Verbitsky and E. Witten for useful discussions. We would also like to thank the SCGP for hospitality during the 11th Simons Workshop on math and physics, where this work was initiated.

The work of C.V. is supported in part by NSF grant PHY-1067976.

A Proofs of identities used in §.3.1

A.1 Eqns.(3.55) and (3.56)

We set $\zeta = 1$ by rescaling μ and $\bar{\mu}$. Then from eqn.(3.53)

$$\Phi(x, \mu, \bar{\mu}) = \frac{1}{2\pi i} \left(\int_0^\infty \frac{dt}{t-i} \sum_{m \geq 1} \frac{e^{-2\pi m(\mu t + \bar{\mu} t^{-1} + ix)}}{m} - (i \leftrightarrow -i) \right), \quad (\text{A.1})$$

and perform the change of variables $t = s^{-1}$

$$\begin{aligned} \Phi(x, \mu, \bar{\mu}) &= \frac{1}{2\pi i} \left(\int_0^\infty \frac{i ds}{s(s+i)} \sum_{m \geq 1} \frac{e^{-2\pi m(\bar{\mu} s + \mu s^{-1} + ix)}}{m} - (i \leftrightarrow -i) \right) = \\ &= \frac{1}{2\pi i} \left(\int_0^\infty ds \left(\frac{1}{s} - \frac{1}{s+i} \right) \sum_{m \geq 1} \frac{e^{-2\pi m(\bar{\mu} s + \mu s^{-1} + ix)}}{m} - (i \leftrightarrow -i) \right) = \\ &= \frac{1}{2\pi i} \left(\int_0^\infty \frac{ds}{s-i} \sum_{m \geq 1} \frac{e^{-2\pi m(\bar{\mu} s + \mu s^{-1} - ix)}}{m} - (i \leftrightarrow -i) \right) + \\ &\quad + \frac{1}{2\pi i} \left(\sum_{m \geq 1} \frac{2i \sin(2\pi m x)}{m} \int_0^\infty \frac{ds}{s} e^{-2\pi m(\bar{\mu} s + \mu s^{-1})} \right). \end{aligned} \quad (\text{A.2})$$

Comparing with eqn.(3.50) we get the desired functional equation for Φ

$$\Phi(x, \mu, \bar{\mu}) - \Phi(-x, \bar{\mu}, \mu) = L(x, \mu, \bar{\mu}). \quad (\text{A.3})$$

As stated in the main body of the text, this is equivalent to the equation for the tt^* metric in terms of the amplitudes Π (at, say, $\zeta = 1$)

$$\log \Pi_{\text{can}} - \log \Pi_{\text{can}}^* = \log G - \log |\eta| \equiv L, \quad (\text{A.4})$$

where Π_{can} are the amplitudes in the canonical base (in which $\eta = 1$), that is,

$$\log \Pi_{\text{can}} = \log \Pi + \frac{1}{2} \log \mu. \quad (\text{A.5})$$

Then, in view of eqn.(3.48), eqn.(A.4) reduces to (A.3) since $\Phi(x, \mu, \bar{\mu})^* = \Phi(-x, \bar{\mu}, \mu)$ on the physical slice where $\bar{\mu} = \mu^*$.

In view of eqn.(3.53), eqn.(3.56) follows from the obvious identity, valid for all natural numbers n ,

$$\log \left(1 - e^{-2\pi n(\mu t + \bar{\mu} t^{-1} + ix)} \right) = \sum_{k=0}^{n-1} \log \left(1 - e^{-2\pi(\mu t + \bar{\mu} t^{-1} + ix + ik/n)} \right). \quad (\text{A.6})$$

A.2 The asymmetric UV limit $\bar{\mu} \rightarrow 0$

Again we set $\zeta = 1$ by a redefinition of the $\mu, \bar{\mu}$, and we assume first the redefined $\mu, \bar{\mu}$ to satisfy $\text{Re } \mu, \text{Re } \bar{\mu} > 0$. From eqn.(3.48) we have

$$\left(\partial_\mu - \partial_x\right) \log \Pi(x, \mu, \bar{\mu}) = \log \mu - \frac{1}{2\mu} + \left(\partial_\mu - \partial_x\right) \Phi(x, \mu, 0), \quad (\text{A.7})$$

while from eqn.(3.53),

$$2\pi i \Phi(x, \mu, 0) = \int_0^\infty \frac{dt}{t-i} \log\left(1 - e^{-2\pi(\mu t + ix)}\right) - \left(i \leftrightarrow -i\right), \quad (\text{A.8})$$

from which we get

$$\begin{aligned} \left(\partial_\mu - \partial_x\right) \Phi(x, \mu, 0) &= -i \int_0^\infty \frac{dt}{1 - e^{-2\pi(\mu t + ix)}} - \left(i \leftrightarrow -i\right) = \\ &= 2 \sum_{n \geq 1} \sin(2\pi n x) \int_0^\infty dt e^{-2\pi n \mu t} = \\ &= \frac{1}{\pi \mu} \sum_{m \geq 1} \frac{\sin(2\pi m x)}{m} = \frac{1}{\mu} \left(\frac{1}{2} - x\right). \end{aligned} \quad (\text{A.9})$$

Plugging this result in (A.7), we get

$$\left(\partial_\mu - \partial_x\right) \log \Pi(x, \mu, 0) = \log \mu - \frac{x}{\mu}. \quad (\text{A.10})$$

This equation has the general solution

$$\log \Pi(x, \mu, 0) = -x \log \mu + f(x + \mu), \quad (\text{A.11})$$

for some function $f(w)$. To fix $f(w)$ it is enough to compute $\log \Pi(x, \mu, 0)$ for a fixed value of x (and all μ). We shall compute it for x a half-integer.

A.2.1 $\log \Pi(x, \mu, 0)$ for $x \in \frac{1}{2}\mathbb{Z}$

For $x \in \mathbb{Z}$ we have

$$\begin{aligned} \Phi(x \in \mathbb{Z}, \mu, \bar{\mu} = 0) &= \frac{1}{2\pi i} \left(\int_0^\infty \frac{dt}{t-i} \sum_{m \geq 1} \frac{e^{-2\pi m \mu t}}{m} - \left(i \leftrightarrow -i\right) \right) = \\ &= \frac{1}{\pi} \int_0^\infty \frac{dt}{t^2 + 1} \sum_{m=1}^\infty \frac{e^{-2\pi m \mu t}}{m} = \\ &= \frac{1}{\pi} \int_0^\infty dt \left(\sum_{m=1}^\infty \frac{e^{-2\pi m \mu t}}{m} \right) \frac{d}{dt} \arctan(t) = \\ &= -\frac{1}{\pi} \int_0^\infty \arctan(t) dt \frac{d}{dt} \sum_{m=1}^\infty \frac{e^{-2\pi m \mu t}}{m} = \\ &= 2\mu \int_0^\infty dt \frac{\arctan(t)}{e^{2\pi \mu t} - 1}. \end{aligned} \quad (\text{A.12})$$

By a change of variables, we rewrite the last expression in the form

$$2 \int_0^\infty dt \frac{\arctan(t/\mu)}{e^{2\pi t} - 1}. \quad (\text{A.13})$$

Then from eqn.(3.58), we have

$$\log \Pi(x \in \mathbb{Z}, \mu, 0) = \left(\mu - \frac{1}{2} \right) \log \mu - \mu + \text{const.} + 2 \int_0^\infty dt \frac{\arctan(t/\mu)}{e^{2\pi t} - 1}. \quad (\text{A.14})$$

Now we invoke Binet's formula

$$\log \Gamma(z) = (z - 1/2) \log z - z + \frac{1}{2} \log(2\pi) + 2 \int_0^\infty \frac{\arctan(t/z)}{e^{2\pi t} - 1} dt, \quad (\text{A.15})$$

to conclude that, choosing the constant in (A.15) to be zero, for all μ with $\text{Re } \mu > 0$, we have

$$\Pi(x \in \mathbb{Z}, \mu, \bar{\mu} = 0) = \frac{\Gamma(\mu)}{\sqrt{2\pi}}, \quad (\text{A.16})$$

as claimed.

For $x \in \frac{1}{2} + \mathbb{Z}$,

$$\log \Pi(x = 1/2, \mu, 0) = \left(\mu - \frac{1}{2} \right) \log \mu - \mu + \Phi(1/2, \mu, 0), \quad (\text{A.17})$$

while, from identity (3.56)

$$\Phi(1/2, \mu, 0) = \Phi(0, 2\mu, 0) - \Phi(0, \mu, 0) \quad (\text{A.18})$$

which in view of eqns.(3.58)(A.16) is equivalent to

$$\log \Pi(x = 1/2, \mu, 0) = \log \Gamma(2\mu) - \log \Gamma(\mu) - \frac{1}{2} \log \mu - (2\mu - 1/2) \log 2. \quad (\text{A.19})$$

Using the Gamma function identity

$$\Gamma(2z) = \pi^{-1/2} 2^{2z-1} \Gamma(z) \Gamma(z + 1/2), \quad (\text{A.20})$$

this becomes

$$\log \Pi(x = 1/2, \mu, 0) = \log \Gamma(\mu + 1/2) - \frac{1}{2} \log \mu - \log \sqrt{2\pi}, \quad (\text{A.21})$$

as claimed.

A.2.2 Kummer formula

For $\epsilon \sim 0$, one has

$$\begin{aligned} \log \Pi(x, \epsilon, 0) + x \log \epsilon &= \log \sqrt{2\pi} + \left(x - \frac{1}{2}\right) \log \epsilon + \frac{1}{\pi} \sum_{m \geq 1} \frac{\cos(2\pi m x)}{m} \int_0^\infty \frac{dt}{t^2 + 1} - \\ &\quad - \frac{1}{\pi} \sum_{m \geq 1} \frac{\sin(2\pi m x)}{m} \int_0^\infty \frac{t dt}{t^2 + 1} e^{-2\pi m \epsilon t} \end{aligned} \quad (\text{A.22})$$

One has

$$\int_0^\infty \frac{t dt}{t^2 + 1} e^{-2\pi m \epsilon t} = -\log(2\pi m \epsilon) - \gamma + O(\epsilon) \quad (\text{A.23})$$

$$\sum_{m \geq 1} \frac{\cos(2\pi m x)}{m} = -\log(2 \sin \pi x) \quad (\text{A.24})$$

$$\sum_{m \geq 1} \frac{\sin(2\pi m x)}{m} = \frac{\pi}{2}(1 - 2x), \quad (\text{A.25})$$

and eqn.(A.22) becomes

$$\begin{aligned} \log \Pi(x, \epsilon, 0) + x \log \epsilon &= \log \sqrt{2\pi} - \frac{1}{2} \log(2 \sin \pi x) + \left(\frac{1}{2} - x\right) \left(\log 2\pi + \gamma\right) + \\ &\quad + \frac{1}{\pi} \sum_{m \geq 1} \frac{\sin(2\pi m x)}{m} \log m + O(\epsilon) \end{aligned} \quad (\text{A.26})$$

According to our results, the limit as $\epsilon \rightarrow 0$ of the LHS is $\log \Gamma(x)$ (for $0 < x < 1$). The resulting expression for $\log \Gamma(x)$ is the celebrated Kummer formula.

A.2.3 The $\zeta = 1$ thimble brane function $\Phi(x, \mu, \bar{\mu})$ for $\text{Re } \mu \geq 0$

In §.3.1.2 we have saw that, for $\text{Re } \mu > 0$, the solution to the tt^* brane amplitude for the model $W = \mu Y - e^Y$, which corresponds to the basic Lefshetz thimble brane, may be written in the form

$$\begin{aligned} \Phi(x, \mu, \bar{\mu}) &= \int_{\mathbb{R}} ds f(s) \equiv - \int_{\mathbb{R}} \frac{ds}{2\pi} \left(\frac{\log[1 - \exp(-2\pi\mu e^s - 2\pi\bar{\mu} e^{-s} - 2\pi i x)]}{e^{-s} + i} + \right. \\ &\quad \left. + \frac{\log[1 - \exp(-2\pi\mu e^s - 2\pi\bar{\mu} e^{-s} + 2\pi i x)]}{e^{-s} - i} \right), \end{aligned} \quad (\text{A.27})$$

the integral being evaluated along the real axis $\mathbb{R} \subset \mathbb{C}$. The integrand $f(s)$ has poles at

$$s = s_k \equiv \frac{i\pi}{2} + k i\pi. \quad (\text{A.28})$$

In §.6.1.2, we need the expression for the function $\Phi(x, \mu, \bar{\mu})$ valid in the region $\text{Re } \mu < 0$, where eqn.(A.27) does not apply since the integral does not converge.

The integral of the meromorphic function $f(s)$ along a contour $\gamma \subset \mathbb{C}$, produces a solution $\Phi(x, \mu, \bar{\mu})_\gamma$ to the tt^* brane amplitude equations provided:

- the integral $\int_\gamma f(s) ds$ is convergent;
- in the physical region $\bar{\mu} = (\mu)^*$, the function $\Phi(x, \mu, \bar{\mu})_\gamma$ satisfies the reality condition

$$\Phi(x, \mu, \bar{\mu})_\gamma - \Phi(-x, \mu, \bar{\mu})_\gamma^* = L(x, \mu, \bar{\mu}). \quad (\text{A.29})$$

For $\text{Re } \mu > 0$ the function $\Phi(x, \mu, \bar{\mu})_\mathbb{R}$ defined by the RHS of (A.27) satisfies both requirements by the functional equation (A.3), together with the identity $\Phi(x, \mu, \bar{\mu})_\mathbb{R}^* = \Phi(x, \bar{\mu}, \mu)_\mathbb{R}$ valid in the physical region.

The Lefschetz thimble amplitude for $\text{Re } \mu < 0$ is given by the integral along the line $\text{Im } \pi$ parallel to the real axis. This contour defines the function $\Phi(x, \mu, \bar{\mu})_{\mathbb{R}+i\pi}$. From the symmetry of the integrand one see that

$$\Phi(x, \mu, \bar{\mu})_{\mathbb{R}+i\pi} = -\Phi(1-x, -\mu, -\bar{\mu})_\mathbb{R}, \quad (\text{A.30})$$

where both sides are well-defined for $\text{Re } \mu < 0$ and satisfy the reality condition (A.29). However, $\Phi_{\mathbb{R}+i\pi}$ is related to *some* amplitude of the form $\langle x|D' \rangle$, whereas we need to compute for $\text{Re } \mu < 0$ the amplitude $\Pi \equiv \langle x|D \rangle$ for the *same* basic brane $|D \rangle$ which is associated to the function $\Phi_\mathbb{R}$ for $\text{Re } \mu > 0$.

A.2.4 The limit $\bar{\mu} \rightarrow 0$ of Π in the negative half-plane

We already know that the $\bar{\mu} = 0$ limit of the $\zeta = 1$ Lefschetz thimble amplitude in the positive half-plane $\text{Re } \mu > 0$ is

$$\log \Pi(x, \mu, 0)_\mathbb{R} = \log \Gamma(\mu + x) - x \log \mu - \log \sqrt{2\pi}, \quad 0 \leq x \leq 1 \quad (\text{A.31})$$

$$\text{i.e. } \Phi(x, \mu, 0)_\mathbb{R} = \log \Gamma(\mu + x) - (\mu + x - 1/2) \log \mu + \mu - \log \sqrt{2\pi}. \quad (\text{A.32})$$

While, from eqn.(A.30),

$$\log \Pi(x, \mu, 0)_{\text{negative half-plane}} = -\Phi(1-x, -\mu, 0)_\mathbb{R} + \left(\mu - \frac{1}{2} \right) \log \mu - \mu. \quad (\text{A.33})$$

Inserting eqn.(A.31), we get

$$\log \Pi(x, \mu, 0)_{\text{negative half-plane}} = -\log \Gamma(1-x-\mu) - x \log \mu + i\pi(x+\mu-1/2) + \log \sqrt{2\pi}, \quad (\text{A.34})$$

which is the expression used in the text.

A.3 Explicit expressions for the CFIV new susy index

From the tt^* metric, we can read the ‘new susy index’ which in the present case reads (we set $M = 2\beta|\mu|$)

$$Q(x, M) \equiv -\frac{M}{2} \frac{\partial L}{\partial M} = -\frac{1}{\pi} \sum_{m \geq 1} \frac{\sin(2\pi m x)}{m} (2\pi m M) K_1(2\pi m M), \quad (\text{A.35})$$

where $K_1(z)$ is the Bessel–MacDonald function of index 1. This expression is particularly useful for large M (IR limit), where the terms in the sum after the first one are negligible. Alternatively we have the Poisson re–summed expressions in terms of a sum over monopole contributions, see eqn.(3.43).

The Poisson re–summed expression for $L(x, M) \equiv \log G(x, M) + \log |\mu|$ reads

$$L(x, M) = (1 - 2x) \left(\log M + \gamma \right) - \sum_{k \in \mathbb{Z}} \log \left(\frac{\sqrt{M^2 + (x - k)^2} + x - k}{\sqrt{M^2 + (k - 1/2)^2} + (1/2 - k)} \exp \left[-(x - 1/2) |k| \right] \right). \quad (\text{A.36})$$

Then

$$Q(x, M) = \left(x - \frac{1}{2} \right) + \frac{1}{2} \sum_{k \geq 1} \left[\frac{(k - x)}{\sqrt{M^2 + (k - x)^2}} + \frac{(1 - k - x)}{\sqrt{M^2 + (1 - k - x)^2}} \right] \quad (\text{A.37})$$

from which we recover the UV result $Q(x, 0) = x - 1/2$. From the periodic $U(1)$ monopole point of view, $Q(x, M)$ is the component $r A_\theta$ of the Abelian connection A in cylindric coordinates ($r = M, \theta, x$) in a suitable gauge.

Besides the two series representations of $Q(x, M)$, (A.35) and (A.37), we give two convenient integral representations. The first one, for $0 < x < 1$, is

$$Q(x, M) = \left(x - \frac{1}{2} \right) - \frac{M^2}{4} \int_{-\infty}^{+\infty} \frac{d\xi}{(\xi^2 + M^2)^{3/2}} \left([x + \xi] + [x - \xi] \right), \quad (\text{A.38})$$

where $[z]$ is the integral part of the real variable z . This formula may be obtained replacing in the integrand $M^2(\xi^2 + M^2)^{-3/2}$ with $d[\xi(\xi^2 + M^2)^{-1/2}]/d\xi$ and integrating by parts: one gets the series (A.37); instead writing $[z] = z - \{z\}$ and plugging in the Fourier series expansion of $\{z\}$ one gets the Bessel series (A.35).

The second one is particularly convenient for checking monotonicity properties

$$Q(x, M) = -\sin(2\pi x) M \int_0^\infty \frac{e^{-\pi M(t+t^{-1})} dt}{1 - 2 \cos(2\pi x) e^{-\pi M(t+t^{-1})} + e^{-2\pi M(t+t^{-1})}}. \quad (\text{A.39})$$

B Technicalities for the 3d chiral (§.6.1)

B.1 Details on the tt^* metric for the 3d free chiral multiplet

As in §., we identify the 3d free chiral multiplet with twisted real mass m , compactified on a circle of length R_y , as the 2d (2, 2) model with superpotential

$$W(Y_n) = \sum_{n \in \mathbb{Z}} \left(e^{Y_n} - \frac{i}{2} \left(\frac{m}{2\pi} + i \frac{n+y}{R_y} \right) Y_n \right). \quad (\text{B.1})$$

The length of the tt^* circle is R_x , and we set $\rho = R_x/R_y$. x is the tt^* vacuum angle with period 1 and y is also a periodic variable of period 1. We write $z = mR_x/2\pi \in \mathbb{R}$. The tt^* quantities for the model (B.1) will be denoted by the boldface version of the symbols used in §.3.1.2 and appendix A to denote the corresponding quantity for the 2d model obtained by neglecting all non-zero KK modes.

Since the various KK modes do not interact, *formally* we have

$$\log \mathbf{G}(x, y, z, \rho) = \left\langle \sum_{n \in \mathbb{Z}} \log G(x, |iz - (n+y)\rho|/2) \right\rangle, \quad (\text{B.2})$$

and we have to give a precise meaning to this expression. The 2d tt^* metric G depends on the chosen basis for the chiral ring \mathcal{R} . In §. 3.1.2 the metric was written in the so-called ‘point’ basis; in the chiral operator basis would read

$$G(x)_{\text{operator basis}} \equiv \langle \overline{e^{xY}} | e^{xY} \rangle = e^{x \log |\mu|^2} G(x)_{\text{point basis}}. \quad (\text{B.3})$$

Instead of summing the series for $\log G$, it is convenient to sum the series for its derivative with respect to x ; still at the pure formal level, we have

$$\begin{aligned} \frac{\partial}{\partial x} \log \mathbf{G}(x, y, z, \rho) &= \sum_{n \in \mathbb{Z}} \frac{\partial}{\partial x} \log G(x, |iz + (y-n)\rho|/2) = \\ &= \sum_{n \in \mathbb{Z}} \left(\log \frac{|iz + (y-n)\rho|^2}{4} - 4 \sum_{m \geq 1} \cos(2\pi mx) K_0(2\pi m |iz + (y-n)\rho|) \right), \end{aligned} \quad (\text{B.4})$$

where the first term in the large parenthesis in the RHS is the effect of the change of basis (B.3) and the other terms are as in eqn.(3.37). One has the identity [68, 69]

$$\begin{aligned} \log \frac{z^2 + y^2}{4} - 4 \sum_{k=1}^{\infty} \cos(2\pi kx) K_0(2\pi k \sqrt{z^2 + y^2}) &= \\ = -\frac{1}{\sqrt{z^2 + y^2 + x^2}} - \sum_{\substack{k \in \mathbb{Z} \\ k \neq 0}} \left(\frac{1}{\sqrt{z^2 + y^2 + (x-k)^2}} - \frac{1}{|k|} \right) - 2\gamma, \end{aligned} \quad (\text{B.5})$$

and hence the RHS of eqn.(B.4) may be seen as a *regularized* version of the formal expression

$$- \sum_{n \in \mathbb{Z}^2} \sum_{k \in \mathbb{Z}} \frac{1}{\sqrt{z^2 + (y-n)^2 \rho^2 + (x-k)^2}} + \text{const}, \quad (\text{B.6})$$

that is, literally, the potential \mathbf{V} for a doubly-periodic array of $U(1)$ monopoles located at $(x, y\rho, z) = (k, n\rho, 0)_{(k,n) \in \mathbb{Z}^2} \subset \mathbb{R}^3$. For a convenient choice of the additive constant, the regularized version is [69]

$$\begin{aligned} \mathbf{V}(x, y, z, \rho) = & \Lambda - \frac{1}{\sqrt{z^2 + y^2 \rho^2 + x^2}} - \\ & - \sum_{\substack{(k,\ell) \in \mathbb{Z}^2 \\ (k,\ell) \neq (0,0)}} \left(\frac{1}{\sqrt{z^2 + (y-\ell)^2 \rho^2 + (x-k)^2}} - \frac{1}{\sqrt{\ell^2 \rho^2 + k^2}} \right), \end{aligned} \quad (\text{B.7})$$

where the constant Λ is

$$\Lambda = 2 \left(\log \frac{4\pi}{\rho} - \gamma \right) - 8 \sum_{k=1}^{\infty} \sum_{\ell=1}^{\infty} K_0(2\pi mn\rho). \quad (\text{B.8})$$

The function \mathbf{V} in eqn.(B.7) is harmonic and doubly periodic, hence solves the tt^* equations. In order to identify it with the correctly normalized tt^* metric, we send the KK radius R_y to zero. In this limit we should recover the 2d answer of §. 3.1.2; indeed, we claim that

$$\lim_{\rho \rightarrow \infty} \mathbf{V} = \frac{\partial}{\partial x} \log G_{2d}, \quad (\text{B.9})$$

where G_{2d} is the 2d tt^* metric *but* in the original point basis. This follows from the Newman expression for the function \mathbf{V} [69, 70]

$$\mathbf{V}(x, y, z, \rho) = \frac{2}{\rho} \log(2|\sin \pi(y+ix/\rho)|) - 4 \sum_{\ell \in \mathbb{Z}} \sum_{k=1}^{\infty} \cos(2\pi kx) K_0(2\pi k \sqrt{z^2 + (y-\ell)^2 \rho^2}), \quad (\text{B.10})$$

As $\rho \rightarrow \infty$ (keeping $y\rho$ fixed) the first term vanishes as do all terms with $\ell \neq 0$; we remain with the 2d expression.

Besides (B.7)(B.10) there is a third equivalent expression of the function $\mathbf{V}(x, y, z, \rho)$ which is useful (for additional representations of \mathbf{V} in terms of Ewald sums and heat kernels see [69])

$$\mathbf{V}(x, y, z, \rho) = 2\pi \frac{|z|}{\rho} - \sum_{\substack{(a,b) \in \mathbb{Z}^2 \\ (a,b) \neq (0,0)}} \frac{1}{\sqrt{a^2 \rho^2 + b^2}} \exp(2\pi i ax + 2\pi i by - 2\pi \sqrt{a^2 + b^2/\rho^2} |z|) \quad (\text{B.11})$$

To get the expressions used in §.6.1, one has to use $z = R_x m / 2\pi$, $\rho = R_x / R_y$ and perform an overall rescaling to get the standard normalization of the monopole potential

$$\begin{aligned}
V(x, y, m, R_x, R_y) &= \frac{R_x}{2} \mathbf{V}(x, y, R_x m / 2\pi, R_x / R_y) \\
&= \frac{2\Lambda}{R_x} - \pi \sum_{\substack{(k, \ell) \in \mathbb{Z}^2 \\ (k, \ell) \neq (0, 0)}} \left(\frac{1}{\sqrt{m^2 + \frac{4\pi^2}{R_y} (y - \ell)^2 + \frac{4\pi^2}{R_x} (x - k)^2}} - \frac{1}{\sqrt{\frac{4\pi^2}{R_y^2} \ell^2 + \frac{4\pi^2}{R_x^2} k^2}} \right) \\
&= \frac{R_x R_y}{2} |m| - \sum_{\substack{(a, b) \in \mathbb{Z}^2 \\ (a, b) \neq (0, 0)}} \frac{R_x R_y}{2 \sqrt{a^2 R_x^2 + b^2 R_y^2}} \exp(2\pi i a x + 2\pi i b y - \sqrt{a^2 R_x^2 + b^2 R_y^2} |m|).
\end{aligned} \tag{B.12}$$

From the above computations we get for the 3d tt^* metric (in a basis which reduces to the 2d point basis as $R_y \rightarrow 0$) we get

$$\mathbf{G}(x, y, m, R_x, R_y) = \exp \left(\frac{2}{R_x} \int_0^x V(x', y, m, R_x, R_y) dx' \right), \tag{B.13}$$

which is eqn.(6.4).

To get the analogue expressions for tetrahedron theory we have just to shift V by a term linear in m , as explained in the main body of the paper.

B.2 The asymmetric UV limit for the 3d brane amplitudes

The amplitudes for the 3d chiral model may be written as a product on the KK modes:

$$\log \Pi_{3d}(m, x, y; \zeta) = \sum_{n \in \mathbb{Z}} \log \Pi_{2d} \left(\mu = \frac{m R_x}{4\pi} + \frac{i R_x}{2 R_y} (y + n); \zeta \right). \tag{B.14}$$

The asymmetric limit of the 3d amplitudes are then the product of the 2d asymmetric limit. Here we limit ourselves to the case $\zeta = -1$ corresponding to Neumann b.c., the extension to $\zeta = +1$ being straightforward. From eqn.(3.59), we have (for $0 \leq x \leq 1$)

$$\begin{aligned}
\log \Pi_{3d}(\mathbf{m}; \zeta = -1) \Big|_{\substack{\text{asymmetric} \\ \text{UV limit}}} &= \\
&= \sum_{n \in \mathbb{Z}} \log \Gamma \left(\frac{\mathbf{m}}{4\pi} + x + \frac{i R_x}{2 R_y} n \right) - x \sum_{n \in \mathbb{Z}} \log \left(\frac{\mathbf{m}}{4\pi} + \frac{i R_x}{2 R_y} n \right),
\end{aligned} \tag{B.15}$$

where

$$\mathbf{m} = m R_x + \frac{2\pi i R_x}{R_y} y, \tag{B.16}$$

is the complexified twisted mass measured in units of the inverse radius R_x^{-1} .

We insert in the expression (B.15) the Weierstrass representation of the Gamma function

$$\log \Gamma(z) = -\gamma z - \log z - \sum_{m=1}^{\infty} \left[\log \left(1 + \frac{z}{m} \right) - \frac{z}{m} \right]. \quad (\text{B.17})$$

The idea is to invert the order of summation in m and n ; unfortunately, the expression is not absolutely convergent (recall that in the asymmetric limit we have infinitely many massless $2d$ fields), and this inversion is not legitimate. However, if we take three derivatives with respect to \mathbf{m} or x the double series becomes absolutely convergent and the inversion of the summations will be allowed. Hence the result is well-defined, without further prescriptions, up to a quadratic polynomial in \mathbf{m} and x (related with the specification of the background field CS level).

With this warning, we perform the inverted-order sum formally, using the symmetric ζ -regularized sums

$$\sum_{n \in \mathbb{Z}} 1 = 1 + 2\zeta(0) = 0 \quad \sum_{n \in \mathbb{Z}} n = \zeta(-1) - \zeta(-1) = 0, \quad (\text{B.18})$$

$$\sum_{n \neq 0} \log n = i\pi \zeta(0) - 2\zeta'(0) = -i\pi/2 + \log 2\pi, \quad (\text{B.19})$$

as well the identity

$$\log s + \sum_{n=1}^{\infty} \log \left(1 + \frac{s^2}{n^2} \right) = \log \sinh(\pi s) - \log \pi. \quad (\text{B.20})$$

We get

$$\begin{aligned} \log \Pi_{3d}(\zeta = -1) = & -\log \Psi \left(e^{-mR_y - 2\pi i y - 4\pi x - 2\pi R_y/R_x}; e^{-4\pi R_y/R_x} \right) - \\ & - \frac{R_y}{4R_x} \left(m + \frac{2\pi i R_x}{R_y} y \right) - x \log \sinh \left[\frac{1}{2} (mR_y + 2\pi i y) \right] + \text{const.}, \end{aligned} \quad (\text{B.21})$$

where the constant is independent of m, y .

References

- [1] S. Cecotti and C. Vafa, ‘Topological–anti-topological fusion’, Nucl. Phys. **B 367**, (1991) 359–461.
- [2] C. Beem, T. Dimofte, and S. Pasquetti, ‘Holomorphic Blocks in Three Dimensions’, [arXiv:1211.1986](#).
- [3] A. Gadde, S. Gukov and P. Putrov, ‘Walls, Lines, and Spectral Dualities in 3d Gauge Theories,’ [arXiv:1302.0015](#).
- [4] E. Witten, ‘SL(2,Z) action on three-dimensional conformal field theories with Abelian symmetry,’ In ‘Shifman, M. (ed.) et al.: From fields to strings, vol. 2’ 1173-1200 [arXiv:0307041](#).

- [5] E. Witten, ‘Topological Sigma Models’, *Commun. Math. Phys.* **118** (1988) 411;
E. Witten, *Nucl. Phys.* ‘On the Structure of the Topological Phase of Two-dimensional Gravity’, **B 340** (1990) 281–332.
- [6] N.J. Hitchin, ‘The Self-Duality Equations on a Riemann Surface’, *Proc. London Math. Soc.* **55** (1987) 56–126
- [7] S. Cecotti and C. Vafa, ‘On Classification of $N = 2$ Supersymmetric Theories’, *Commun. Math. Phys.* **158** (1993) 569–644. [arXiv:hep-th/9211097](#).
- [8] C. Vafa, “Topological Landau-Ginzburg models,” *Mod. Phys. Lett. A* **6**, 337 (1991).
- [9] M. Aganagic and C. Vafa, ‘Mirror symmetry, D-branes and counting holomorphic discs,’ [arXiv:0012041](#).
- [10] M. Aganagic, A. Klemm and C. Vafa, ‘Disk instantons, mirror symmetry and the duality web,’ *Z. Naturforsch. A* **57**, 1 (2002) [arXiv:0105045](#).
- [11] K. Hori, A. Iqbal, and C. Vafa, ‘D-branes and Mirror Symmetry’, [arXiv:hep-th/0005247](#).
- [12] K. Hori and C. Vafa, ‘Mirror symmetry’, [arXiv:hep-th/0002222](#).
- [13] M. Herbst, K. Hori and D. Page, ‘Phases Of $N=2$ Theories In 1+1 Dimensions With Boundary,’ [arXiv:0803.2045](#) [[hep-th](#)].
- [14] D. Gaiotto, S. Gukov and N. Seiberg, ‘Surface Defects and Resolvents,’ *JHEP* **1309**, 070 (2013) [arXiv:1307.2578](#).
- [15] P. Griffiths and J. Harris, *Principles of Algebraic Geometry*, Wiley (1978).
- [16] S.M. Salamon, ‘Quaternionic manifolds’, *Symposia Mathematica* **26** (1982) 143–171.
- [17] T. Nitta, ‘Vector bundles over quaternionic Kähler manifolds’, *Tôhoku Math. J.* **40** (1988) 425–440.
- [18] M. Verbitsky, ‘Hyperholomorphic bundles over a hyperKähler manifold’, *J. Alg. Geom.* **5** (1996) 633–669.
- [19] C. Bartocci, U. Bruzzo, and D. Hernandez Ruiperez, *Diff. Geom. and Appl.* **8** (1998) 239–249.
- [20] S. Cecotti, A. Neitzke, and C. Vafa, ‘R-Twisting and 4d/2d Correspondences’, [arXiv:1006.3435](#).
- [21] D. Gaiotto, G.W. Moore, and A. Neitzke, ‘Wall-Crossing in Coupled 2d-4d Systems,’ *JHEP* **12** (2012) 082, [arXiv:1103.2598](#).
- [22] G. E. Andrews, R. Askey, and R. Roy, *Special Functions*, *ENCYCLOPEDIA OF MATHEMATICS AND ITS APPLICATIONS* **71**, Cambridge University Press (2009).
- [23] S. Cecotti, P. Fendley, K. Intriligator, and C. Vafa, ‘A New Supersymmetric Index’, *Nucl. Phys.* **B 386** (1992) 405–452, [arXiv:hep-th/9204102](#).
- [24] S. Cecotti and C. Vafa, ‘2d Wall-Crossing, R-Twisting, and a Supersymmetric Index’, [arXiv:1002.3638](#).

- [25] N. Nekrasov and E. Witten, ‘The Omega deformation, branes, integrability, and Liouville theory,’ [arXiv:1002.0888 \[hep-th\]](#) .
- [26] B. Dubrovin, ‘Geometry and Integrability of Topological–Antitopological Fusion’, *Commun. Math. Phys.* **152** (1993) 539–564, [arXiv:hep-th/9206037](#).
- [27] S. Cecotti and C. Vafa, ‘Ising Model and $N = 2$ Supersymmetric Theories’, *Commun. Math. Phys.* **157** (1993) 139–178, [arXiv:hep-th/9209085](#).
- [28] W. Nahm, ‘The construction of all self–dual multi–monopoles by the ADHM method’, In: Craigie et al. (eds.), *Monopoles in quantum theory*, Singapore, World Scientific 1982;
W. Nahm, ‘Self–dual monopoles and calorons’, in: G. Denardo, G. Ghirardi and T. Weber (eds.), *Group theoretical methods in physics*, LECTURE NOTES IN PHYSICS **201**, Berlin, Springer, 1984.
- [29] N. Hitchin, ‘Construction of monopoles’, *Commun. Math. Phys.* **89** (1983) 145–190.
- [30] E. Corrigan and P. Goddard, ‘Construction of instantons and monopoles solutions and reciprocity’, *Ann. Phys.* **154** (1984) 253–279.
- [31] P. Braam and P. van Baal, ‘Nahm’s transformations for instantons’, *Commun. Math. Phys.* **122** (1989) 267–280.
- [32] H. Nakajima, ‘Monopoles and Nahm’s equations’. In: T. Mabuchi and S. Mukai (eds.), *Einstein metrics and Yang–mills connections*, LECTURE NOTES IN PURE AND APPL. MATH. **145**, Dekker, New York, 1993.
- [33] M. Jardim, ‘A survey on Nahm transform’, *J. Geom. Phys.* **52** (2004) 313–327, [arXiv:math/0309305](#).
- [34] C. Bartocci, U. Bruzzo, and D. Hernández Ruipérez, *Fourier–Mukai and Nahm Transforms in Geometry and Mathematical Physics*, PROGRESS IN MATHEMATICS volume **276**, Birkhäuser (2009).
- [35] S. Mukai, ‘Duality between $D(X)$ and $D(\hat{x})$ with application to Picard sheaves’, *Nagoya Math. J.* **81** (1981) 153–175.
- [36] S. Cecotti, ‘ $N = 2$ Landau–Ginzburg versus Calabi–Yau sigma models: Nonperturbative aspects’, *Int. J. Mod. Phys.* **A6** (1991) 1749–1814.
- [37] M. Atiyah, V. Drinfel’d, N. Hitchin, and Yu. Manin, ‘Construction of instantons’, *Phys. Lett.* **A 65** (1978) 185–187.
- [38] E.B. Bogomol’nyi, *Sov. J. Nucl. Phys.* **24** (1976) 449.
- [39] S. Cherkis and A. Kapustin, ‘Nahm Transform for Periodic Monopoles and $N = 2$ Super Yang–Mills Theory’, *Commun. Math. Phys.* **218** (2001) 333–371, [arXiv:hep-th/0006050](#).
- [40] S. A. Cherkis and R. S. Ward, ‘Moduli of Monopole Walls and Amoebas,’ *JHEP* **1205**, 090 (2012) [arXiv:1202.1294](#).
- [41] M. Jardim, ‘Construction of doubly–periodic instantons’, *Commun. Math. Phys.*

- 216** (2001) 1–15;
M. Jardim, ‘Nahm transform and spectral curves for doubly-periodic instantons’,
Commun. Math. Phys. **225** (2002) 639–668;
M. Jardim, ‘Classification and existence of doubly-periodic instantons’, Q. J. Math.
53 (2002) 431–442,
- [42] C. Bartocci and M. Jardim, ‘Hy[erkähler Nahm transform’, CRM Proceedings and
Lecture Notes **38** (2004) pp.103–111. [arXiv:math/0312045](#).
- [43] A. Kapustin and B. Willett, ‘Wilson loops in supersymmetric Chern–Simons–matter
theories and duality’, [arXiv:1302.2164](#).
- [44] E. Witten, ‘Quantum Field Theory and the Jones Polynomial’, Commun. Math.
Phys. **121** (1981) 351–399.
- [45] T. Dimofte, D. Gaiotto and S. Gukov, ‘Gauge Theories Labelled by
Three-Manifolds,’ [arXiv:1108.4389 \[hep-th\]](#).
- [46] T. Dimofte, D. Gaiotto and S. Gukov, ‘3-Manifolds and 3d Indices,’
[arXiv:1112.5179](#).
- [47] S. Cecotti, C. Cordova and C. Vafa, ‘Braids, Walls, and Mirrors,’ [arXiv:1110.2115](#).
- [48] E. Verlinde, ‘Fusion rules and modular transformations in 2d conformal field theory’,
Nucl. Phys. **B 300** (1988) 360.
- [49] N. Hama, K. Hosomichi and S. Lee, ‘SUSY Gauge Theories on Squashed
Three-Spheres’, JHEP **1105** (2001) 014 [arXiv:1102.4716 \[hep-th\]](#).
- [50] S. Pasquetti, ‘Factorization of $\mathcal{N} = 2$ theories on the squashed 3-sphere’,
[arXiv:1111.6905 \[hep-th\]](#).
- [51] D.S. Park and J. Song, ‘The Seiberg–Witten Kähler Potential as a Two-Sphere
Partition Function’, [arXiv:1211.0019 \[hep-th\]](#).
- [52] F. Benini and S. Cremonesi, ‘Partition functions of $N=(2,2)$ gauge theories on S^2
and vortices’, [arXiv:1206.2356 \[hep-th\]](#).
- [53] N. Doroud, J. Gomis, B. Le Floch and S. Lee, ‘Exact results in $D=2$ supersymmetric
gauge theories’, [arXiv:1206.2606 \[hep-th\]](#).
- [54] K. Hori and M. Romo, ‘Exact Results In Two-Dimensional $(2,2)$ Supersymmetric
Gauge Theories With Boundary,’ [arXiv:1308.2438](#).
- [55] S. H. Katz, A. Klemm and C. Vafa, ‘Geometric engineering of quantum field
theories,’ Nucl. Phys. B **497**, 173 (1997) [arXiv:9609239](#).
- [56] S. Katz, P. Mayr and C. Vafa, ‘Mirror symmetry and exact solution of 4-D $N=2$
gauge theories: 1.,’ Adv. Theor. Math. Phys. **1**, 53 (1998) [arXiv:9706110](#).
- [57] N. C. Leung and C. Vafa, ‘Branes and toric geometry,’ Adv. Theor. Math. Phys. **2**,
91 (1998) [arXiv:9711013](#).
- [58] O. Aharony, A. Hanany and B. Kol, ‘Webs of (p,q) five-branes, five-dimensional field

- theories and grid diagrams,’ JHEP **9801**, 002 (1998) [arXiv:9710116](#).
- [59] C. Vafa, ‘Supersymmetric Partition Functions and a String Theory in 4 Dimensions,’ [arXiv:1209.2425](#).
- [60] M. Aganagic, T. Ekhholm, L. Ng and C. Vafa, “Topological Strings, D-Model, and Knot Contact Homology,” [arXiv:1304.5778](#).
- [61] C. Cordova, S. Espahbodi, B. Haghighat, A. Rastogi and C. Vafa, “Tangles, Generalized Reidemeister Moves, and Three-Dimensional Mirror Symmetry,” [arXiv:1211.3730](#).
- [62] T. J. Hollowood, A. Iqbal and C. Vafa, ‘Matrix models, geometric engineering and elliptic genera,’ JHEP **0803**, 069 (2008) [arXiv:0310272](#).
- [63] B. Haghighat, A. Iqbal, C. Kozcaz, G. Lockhart and C. Vafa, ‘M-Strings,’ [arXiv:1305.6322](#).
- [64] B. Haghighat, C. Kozcaz, G. Lockhart and C. Vafa, ‘On orbifolds of M-Strings,’ [arXiv:1310.1185](#).
- [65] D. Gepner, ‘Fusion rings and geometry,’ Commun. Math. Phys. **141**, 381 (1991).
- [66] K. A. Intriligator, ‘Fusion residues,’ Mod. Phys. Lett. A **6**, 3543 (1991) [arXiv:9108005](#).
- [67] E. Witten, ‘The Verlinde algebra and the cohomology of the Grassmannian,’ In ‘Cambridge 1993, Geometry, topology, and physics’ 357-422 [arXiv:9312104](#).
- [68] I.S. Gradshteyn and I.M. Ryzhik, *Tables of integrals, series and products*, New York, Academic Press.
- [69] C.M. Linton, ‘Rapidly convergent representations for Green’s functions for Laplace’s equation’, Proc. R. Soc. London **A 455** (1999) 1767–1797.
- [70] J.N. Newman, ‘The Green function for potential flow in a rectangular channel’, J. Engng Math. **26** 51–59.
- [71] F.W.J. Olver, D.W. Lozier, R.F. Boisvert, and C.W. Clark, *NIST Handbook of Mathematical Functions*, Cambridge University Press (2010).
- [72] S. Hohenegger and A. Iqbal, ‘M-strings, Elliptic Genera and N=4 String Amplitudes,’ [arXiv:1310.1325](#).
- [73] O. J. Ganor, A. Y. Mikhailov and N. Saulina, ‘Constructions of noncommutative instantons on $T^{**}4$ and $K(3)$,’ Nucl. Phys. B **591**, 547 (2000) [arXiv:0007236](#).
- [74] Y. -K. E. Cheung, O. J. Ganor, M. Krogh and A. Y. Mikhailov, ‘Instantons on a noncommutative $T^{**}4$ from twisted (2,0) and little string theories,’ Nucl. Phys. B **564**, 259 (2000) [arXiv:9812172](#).
- [75] E. Witten, ‘Supersymmetric index in four-dimensional gauge theories’, Adv. Theor. Math. Phys. **5** (2002) 841–907 [arXiv:hep-th/0006010](#).
- [76] A. Borel, R. Freedman, and J.W. Morgan, *Almost commuting elements in compact*

- Lie groups*, Memoirs of the American Mathematical Society, **157** no. 747 (2002).
- [77] E. Witten, “SL(2,Z) action on three-dimensional conformal field theories with Abelian symmetry,” In *Shifman, M. (ed.) et al.: From fields to strings, vol. 2* 1173-1200 [hep-th/0307041](#).
- [78] D. Gaiotto and E. Witten, “S-Duality of Boundary Conditions In N=4 Super Yang-Mills Theory,” *Adv. Theor. Math. Phys.* **13**, 721 (2009) [arXiv:0807.3720](#).
- [79] C. Ford and J. M. Pawłowski, “Doubly periodic instantons and their constituents,” *Phys. Rev. D* **69**, 065006 (2004) [hep-th/0302117](#).
- [80] A. Hanany and A. Zaffaroni, “Branes and six-dimensional supersymmetric theories,” *Nucl. Phys. B* **529**, 180 (1998) [hep-th/9712145](#).
- [81] F. Benini, S. Benvenuti and Y. Tachikawa, “Webs of five-branes and N=2 superconformal field theories,” *JHEP* **0909**, 052 (2009) [arXiv:0906.0359](#) .
- [82] D. Correa, J. Maldacena and A. Sever, “The quark anti-quark potential and the cusp anomalous dimension from a TBA equation,” *JHEP* **1208**, 134 (2012) [arXiv:1203.1913](#).