

Asymptotic Compressibility of Entanglement and Classical Communication in Distributed Quantum Computation

Eyuri Wakakuwa and Mio Murao

Abstract

We consider implementations of a bipartite unitary on many pairs of unknown input states by local operation and classical communication assisted by shared entanglement. We investigate to what extent the entanglement cost and the classical communication cost can be compressed by allowing nonzero but vanishing error in the asymptotic limit of infinite pairs. We show that a lower bound on the minimal entanglement cost, the forward classical communication cost, and the backward classical communication cost per pair is given by the Schmidt strength of the unitary. We also prove that an upper bound on these three kinds of the cost is given by the amount of randomness that is required to partially decouple a tripartite quantum state associated with the unitary. In the proof, we construct a protocol in which quantum state merging is used. For generalized Clifford operators, we show that the lower bound and the upper bound coincide. We then apply our result to the problem of distributed compression of tripartite quantum states, and derive a lower and an upper bound on the optimal quantum communication rate required therein.

I. INTRODUCTION

ONE of the major interests in quantum information theory is to reveal the interconvertibility among different types of resources, such as quantum channels, noisy and noiseless entanglement, classical channels, and classical correlations. In the asymptotic limit of many copies, the rates at which those resources are interconvertible are derived in coding theorems. A theoretical framework composed of such coding theorems are called quantum Shannon theory [1]–[3]. Recently, it is shown that most of the central coding theorems in quantum Shannon theory can be systematically derived from protocols called quantum state merging [4], [5], the fully quantum Slepian-Wolf [6], or its generalization called quantum state redistribution [7]–[10]. The main technical tool in their proof is the decoupling theorem [11]–[13]. Main tasks considered in quantum Shannon theory such as *transmitting information* and *establishing entanglement* turned out to be convertible into the task of *destroying correlation between a system and the reference system*.

In classical information theory, however, not only *transmitting information* but also *computing a function* is an object of study [14], [15]. Suppose that two distant parties Alice and Bob are given random bits $\mathbf{x} = (x^{(1)}, \dots, x^{(l)})$ and $\mathbf{y} = (y^{(1)}, \dots, y^{(l)})$, respectively, and try to compute a function $f(\mathbf{x}, \mathbf{y})$. Such a task is called distributed function computation. One way to compute f is that Alice sends all \mathbf{x} to Bob and Bob locally computes $f(\mathbf{x}, \mathbf{y})$, which apparently requires l bits of communication. But depending on f , there are cases when the communication cost can be reduced below l bits. For example, if $l = 2$ and $f(\mathbf{x}, \mathbf{y}) = x^{(1)} \cdot y^{(1)} + y^{(2)}$, only 1 bit of communication is sufficient, because only Alice have to send $x^{(1)}$ to Bob. Moreover, when Alice and Bob are given $\mathbf{x}_1, \dots, \mathbf{x}_n$ and $\mathbf{y}_1, \dots, \mathbf{y}_n$ from i.i.d. information sources, and try to compute $f(\mathbf{x}_1, \mathbf{y}_1), \dots, f(\mathbf{x}_n, \mathbf{y}_n)$, there are cases when the classical communication cost can be *compressed* depending on f . That is, by allowing nonzero but vanishing error in the limit of $n \rightarrow \infty$, the total communication cost per input pair can be reduced below the single-shot limit.

A quantum analog of distributed function computation would be distributed quantum computation [16], [17]. Among many tasks, one of the simplest is implementations of bipartite unitaries on unknown input states by local operation and classical information (LOCC) assisted by shared entanglement. Suppose Alice and Bob have quantum systems A and B in unknown states $|\psi\rangle^A$ and $|\phi\rangle^B$, respectively, and try to apply a unitary U^{AB} by entanglement-assisted LOCC (EALOCC). A trivial way is one using quantum teleportation [18], where Alice teleports her input system to Bob, Bob performs the unitary, and then he teleports Alice's input system back to her. In the case of two-qubit unitaries, such a protocol consumes two Bell pairs and two bits of classical communication in both direction. But in [19], a protocol is proposed for performing two-qubit controlled-unitary gates deterministically and exactly by using one ebit of entanglement resource and one bit of classical communication in both direction. This result indicates that, as well as the classical distributed function computation, there are cases where we can reduce the cost of resources depending on the unitary.

This work is supported in part by Project for Developing Innovation Systems of Ministry of Education, Culture, Sports, Science and Technology (MEXT), Japan. The work of E. Wakakuwa is supported by ALPS. The work of M. Murao is supported from JSPS by KAKENHI (Grant No. 23540463 and 26330006). This work was presented in part at the 2014 Quantum Information Processing workshop.

E. Wakakuwa is with the Department of Physics, Graduate School of Science, The University of Tokyo (email: wakakuwa@eve.phys.s.u-tokyo.ac.jp).

M. Murao is with the Department of Physics, Graduate School of Science, The University of Tokyo, and is with Institute for Nano Quantum Information Electronics, The University of Tokyo.

Many studies have been made on such a task, particularly to find more efficient protocols which consume less resources [19]–[27], and to derive minimum amount of resources that are required to accomplish the task [28], [29]. However, finding out efficient protocols is difficult in general. Moreover, most studies have only focused on single-shot protocols.

In the present paper, we investigate compressibility of the entanglement cost and the classical communication cost in EALOCC implementations of bipartite unitaries by considering an asymptotic scenario. We consider a task of applying $(U^{AB})^{\otimes n}$ on $(|\Phi_d\rangle^{AR_A}|\Phi_d\rangle^{BR_B})^{\otimes n}$ by EALOCC, where R_A and R_B are inaccessible reference systems, $\dim\mathcal{H}^A = \dim\mathcal{H}^B = d$ and Φ_d is a d -dimensional maximally entangled state. This is equivalent to performing $(U^{AB})^{\otimes n}$ on an arbitrary unknown input state $|\psi\rangle \in (\mathcal{H}^A \otimes \mathcal{H}^B)^{\otimes n}$. We allow nonzero but vanishing error in the asymptotic limit of $n \rightarrow \infty$. We investigate the minimum amount of the entanglement cost, the forward and the backward classical communication cost per input pair in the asymptotic limit.

We prove that a lower bound on the minimum amount of the three costs per pair is given by a parameter called the Schmidt strength of the unitary (*Theorem 3*). To derive an upper bound, we focus on the fact that applying $(U^{AB})^{\otimes n}$ on $(|\Phi_d^{AR_A}\rangle|\Phi_d^{BR_B}\rangle)^{\otimes n}$ is equivalent to transforming $|\Psi(U^\dagger)\rangle^{\otimes n} := (U^{\dagger AB}|\Phi_d^{AR_A}\rangle|\Phi_d^{BR_B}\rangle)^{\otimes n}$ into $(|\Phi_d^{AR_A}\rangle|\Phi_d^{BR_B}\rangle)^{\otimes n}$. That is, for a given state $|\Psi(U^\dagger)\rangle^{\otimes n}$, Alice and Bob need to decouple AR_A and BR_B , while preserving entanglement between AB and R_AR_B . For this task, we construct a three-turn protocol consisting of two steps. In the first step, Alice performs a measurement on her system, sends the result to Bob, and Bob applies a unitary on his system. In the second step, Bob sends a part of his system to Alice by quantum state merging. We find that Alice’s measurement must decouple AR_A and R_B (*Lemma 4*). That is, we need to find a quantum operation on A that decouples AR_A and R_B . The cost of randomness required in this decoupling process turns out to be equal to the entanglement cost, the forward and the backward classical communication cost in the protocol (*Theorem 7*). Thus we derive an upper bound on the optimal amount of the three costs in terms of the decoupling cost.

For generalized Clifford operators, we prove that the lower bound and the upper bound coincide, thus we derive the optimal entanglement cost, the forward and the backward classical communication cost (*Theorem 10*).

We then relate our results to an apparently different task in quantum Shannon theory, namely, distributed compression of multipartite quantum states. In distributed compression, multiple senders A_1, \dots, A_m initially share n identical copies of a pure state $|\psi\rangle^{A_1 \dots A_m R}$, where R is a reference system. The task is to compress their shares and transmit them to a receiver with a vanishingly small error, only by quantum communication from each of the m parties to the receiver. Contrary to the bipartite setting [6], [30], little has been known on more than bipartite case since it was first formulated and analyzed in [31]. In the present paper, we consider distributed compression of tripartite states associated with bipartite unitaries in a specific setting, and derive a lower and an upper bound on the optimal quantum communication rate required therein.

The structure of this paper is as follows. In Section II, we review results from previous studies on EALOCC implementations of bipartite unitaries in the single-shot regime. In Section III we give the formulation of our problem. In Section IV, we derive a lower bound on the three kinds of the cost. In Section V, we consider single-shot protocols for implementing bipartite unitaries by three-turn LOCC started by Alice’s measurement. We derive conditions on Alice’s measurement. In Section VI, using the result in Section V, we derive an upper bound on the three kinds of the cost. In Section VII, we prove that for generalized Clifford operators, the lower bound and the upper bound coincide. In Section VIII, we apply our results to the problem of distributed compression of tripartite quantum states. Conclusions and discussions are given in Section IX.

Notations. We abbreviate $(M^A \otimes I^B)|\psi\rangle^{AB}$ as $M^A|\psi\rangle^{AB}$ and $(M^A \otimes I^B)\rho^{AB}(M^A \otimes I^B)^\dagger$ as $M^A\rho^{AB}M^{A\dagger}$. For $|\phi\rangle^{AB}$, ϕ^A and $\text{Tr}_B[|\phi\rangle\langle\phi|]$ represents $\text{Tr}_B[|\phi\rangle\langle\phi|]$. When \mathcal{E}^A is a quantum operation on A , we abbreviate $(\mathcal{E}^A \circ \text{id}^B)(\rho^{AB})$ as $\mathcal{E}^A(\rho^{AB})$. $\mathcal{E}(|\phi\rangle\langle\phi|)$ represents $\mathcal{E}(|\phi\rangle\langle\phi|)$. We denote a system composed of n identical systems A as A^n and \bar{A} . The fidelity of the states ρ and σ is defined as $F(\rho, \sigma) = (\text{Tr}\sqrt{\sqrt{\rho}\sigma\sqrt{\rho}})^2$. We abbreviate $F(\rho, |\phi\rangle\langle\phi|)$ as $F(\rho, |\phi\rangle)$.

II. PRELIMINARIES

In EALOCC implementations of bipartite unitaries, Alice and Bob apply a bipartite unitary U^{AB} on unknown quantum states $\varphi^A \in \mathcal{H}^A$ and $\psi^B \in \mathcal{H}^B$, by LOCC using some resource entanglement shared between the parties in advance. Protocols for this task are classified in terms of the success probability and the fidelity of the final state to the target state $U^{AB}|\varphi\rangle^A|\psi\rangle^B$. A protocol is called *deterministic* if it succeeds in implementing U^{AB} with the probability one, otherwise it is called *probabilistic*. A protocol is called *exact* if the fidelity of the final state to the target state is one, otherwise it is called *approximate*.

Many studies have been made to find more efficient protocols which consume less resources [19]–[27]. A probabilistic and approximate protocol for two-qubit unitaries is proposed and investigated in [20]. Probabilistic and exact protocols for two-qubit unitaries are studied in [21]–[23]. A deterministic and exact protocol for two-qubit unitaries is proposed in [19], and those for general bipartite unitaries are studied in [26], [27]. In [28], the minimum entanglement cost of deterministic and exact protocols for two-qubit controlled-unitaries is investigated. It is shown that any protocol for that task requires at least 1 ebit of entanglement when the resource state is a pure entanglement with the Schmidt rank 2, despite the fact that the controlled-unitary can be almost equal to the identity operator. The result is generalized for arbitrary bipartite unitaries in [29]. It is also shown numerically in [29] that there exists a class of two-qubit controlled-unitaries which can be implemented exactly and deterministically by using entanglement resource with the Schmidt rank 3, but with the entanglement entropy less than 1 ebit.

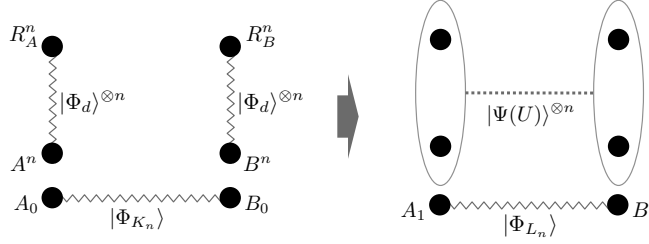

Fig. 1. The task we consider in this paper is to apply $(U^{AB})^{\otimes n}$ on $(|\Phi_d\rangle^{ARA}|\Phi_d\rangle^{BRB})^{\otimes n}$ by using the resource entanglement $\Phi_{K_n}^{A_0 B_0}$. The fact that R_A and R_B are inaccessible to Alice and Bob makes the problem nontrivial. The entanglement cost is defined as the difference between the initial entanglement and the final entanglement shared by Alice and Bob.

A difficulty in investigating EALOCC implementations of bipartite unitaries originates from the fact that we have no guiding principle in searching efficient protocols. Consequently, previous approaches are mostly case-by-case studies which cannot be straightforwardly generalized. In what follows, we show that the decoupling point of view, which is a powerful tool in quantum Shannon theory, may be one of such guiding principles. Although our main focus is an asymptotic scenario, our decoupling-based method would also be helpful in investigating single-shot protocols, as it is indicated in Section V.

III. FORMULATION OF THE PROBLEM

We consider a task in which Alice and Bob apply a bipartite unitary U^{AB} on unknown quantum states $\varphi^A \in \mathcal{H}^A$ and $\psi^B \in \mathcal{H}^B$, by LOCC using a resource state $\phi^{A_0 B_0}$ shared in advance. We assume that $\dim \mathcal{H}^A = \dim \mathcal{H}^B = d$. The equivalent task is that Alice and Bob apply U^{AB} on $|\Phi_d\rangle^{ARA}|\Phi_d\rangle^{BRB}$ by LOCC with a resource state $\phi^{A_0 B_0}$. Here, Φ_d is a d -dimensional maximally entangled state. R_A and R_B are reference systems that are inaccessible and invisible to Alice and Bob.

As an asymptotic version of the protocol, we consider a task in which Alice and Bob applies $(U^{AB})^{\otimes n}$ on $(|\Phi_d\rangle^{ARA}|\Phi_d\rangle^{BRB})^{\otimes n}$ by LOCC using a resource state $\Phi_{K_n}^{A_0 B_0}$ (Fig. 1). Again R_A and R_B are reference systems that Alice and Bob cannot access. We evaluate the efficiency of the protocol by the fidelity between the final state of the protocol and the desired state $(U^{AB})^{\otimes n}|\Phi_d\rangle^{ARA}|\Phi_d\rangle^{BRB}$. We do not require that the fidelity is unity for finite n . Instead, we require that the fidelity converges to one in the limit of $n \rightarrow \infty$. A rigorous definition is below.

Definition 1 Consider a unitary $U : \mathcal{H}^A \otimes \mathcal{H}^B \rightarrow \mathcal{H}^A \otimes \mathcal{H}^B$ acting on two d -level systems A and B . Let $|\Psi(U)\rangle := U^{AB}|\Phi_d\rangle^{ARA}|\Phi_d\rangle^{BRB}$. Let Alice and Bob have registers A_0, A_1 and B_0, B_1 , respectively. We refer to the following quantum operation \mathcal{M}_n as an EALOCC implementation of $U^{\otimes n}$ with the error ϵ_n , the entanglement cost $\log K_n - \log L_n$, the forward classical communication cost C_n^{\rightarrow} , and the backward classical communication cost C_n^{\leftarrow} . Here, $\mathcal{M}_n : A^n A_0 \otimes B^n B_0 \rightarrow A^n A_1 \otimes B^n B_1$ is a LOCC and

$$F(\rho(\mathcal{M}_n), |\Psi(U)\rangle^{\otimes n} |\Phi_{L_n}\rangle^{A_1 B_1}) \geq 1 - \epsilon_n \quad (1)$$

for $\rho(\mathcal{M}_n) = \mathcal{M}_n(|\Phi_d\rangle^{ARA})^{\otimes n} |\Phi_d\rangle^{BRB})^{\otimes n} |\Phi_{K_n}\rangle^{A_0 B_0}$. C_n^{\rightarrow} and C_n^{\leftarrow} is the total amount of classical communication transmitted from Alice to Bob and Bob to Alice, respectively, in \mathcal{M}_n , measured by bits.

Definition 2 A rate triplet $(R_E, C^{\rightarrow}, C^{\leftarrow})$ is said to be achievable if there exists a sequence of EALOCC implementations of $U^{\otimes n}$ such that $\epsilon_n \rightarrow 0$, $\frac{1}{n}(\log K_n - \log L_n) \rightarrow R_E$, $\frac{1}{n}C_n^{\rightarrow} \rightarrow C^{\rightarrow}$ and $\frac{1}{n}C_n^{\leftarrow} \rightarrow C^{\leftarrow}$ in the limit of $n \rightarrow \infty$. The set of all achievable rate triplets is called the rate region.

Let $\hat{\mathcal{M}}_n$ be the action of \mathcal{M}_n on $A^n B^n$. The condition (1) implies that, for *almost all* input states $|\phi\rangle \in \mathcal{H}^{A^n} \otimes \mathcal{H}^{B^n}$, the final state $\hat{\mathcal{M}}_n(\phi^{A^n B^n})$ is sufficiently close to the desired state $U^{\otimes n}|\phi\rangle$. Indeed, due to the relation between entanglement fidelity and ensemble fidelity [32], the condition (1) implies

$$\int_{\phi} p(d\phi) F(\hat{\mathcal{M}}_n(\phi), U^{\otimes n}|\phi\rangle) \geq 1 - \epsilon_n, \quad (2)$$

where the average is taken with respect to the Haar measure on $\mathcal{H}^{A^n} \otimes \mathcal{H}^{B^n}$ (see Appendix A). On the other hand, we do not require that the protocol is *universal* in the sense that $\hat{\mathcal{M}}_n(\phi^{A^n B^n})$ is close to the desired state $U^{\otimes n}|\phi\rangle$ for *all* input states $|\phi\rangle \in \mathcal{H}^{A^n} \otimes \mathcal{H}^{B^n}$.

In the form of the resource inequality [1], [2], we are trying to find the set of rate triplets $(R_E, C^{\rightarrow}, C^{\leftarrow})$ that satisfies

$$R_E[qq] + C^{\rightarrow}[c \rightarrow c] + C^{\leftarrow}[c \leftarrow c] \geq \left\langle U^{AB} : \frac{1}{d^2} I^{AB} \right\rangle. \quad (3)$$

The R.H.S. is the *relative resource* in the sense of [33], which represents an operation on AB that is guaranteed to behave like the unitary U only if the reduced average state of the input is close to $(\frac{1}{d^2}I^{AB})^{\otimes n}$.

IV. LOWER BOUND

Any bipartite unitary acting on $\mathcal{H}_A \otimes \mathcal{H}_B$ is decomposed as

$$U^{AB} = \sum_{s=1}^S c_s E_s^A \otimes F_s^B,$$

where $c_s > 0, E_s \in \mathcal{L}(\mathcal{H}^A), F_s \in \mathcal{L}(\mathcal{H}^B), \sum_{k=1}^S c_s^2 = 1$ and $d^{-1}\text{Tr}[E_s^\dagger E_{s'}] = d^{-1}\text{Tr}[F_s^\dagger F_{s'}] = \delta_{ss'}$. It is called the operator Schmidt decomposition and S is called the operator Schmidt number. The Schmidt strength of the unitary U is defined as $K(U) := -\sum_{s=1}^S c_s^2 \log c_s^2$ [34], [35]. Let $|\phi_s\rangle := E_s^A |\Phi_d\rangle^{AR_A}$ and $|\psi_s\rangle := F_s^B |\Phi_d\rangle^{BR_B}$. Then we have $\langle \psi_s | \psi_{s'} \rangle = \langle \phi_s | \phi_{s'} \rangle = \delta_{ss'}$ and $|\Psi(U)\rangle = \sum_{s=1}^S c_s |\psi_s\rangle^{AR_A} |\phi_s\rangle^{BR_B}$. Thus the entanglement entropy of $|\Psi(U)\rangle$ between AR_A and BR_B is equal to $K(U)$.

Theorem 3 A rate triplet $(R_E, C^\rightarrow, C^\leftarrow)$ is achievable only if $R_E, C^\rightarrow, C^\leftarrow \geq K(U)$.

Proof: $R_E \geq K(U)$ follows from the monotonicity of entanglement under LOCC. To prove $C^\rightarrow, C^\leftarrow \geq K(U)$, we show that if Alice and Bob can apply U^{AB} on $|\Phi_d\rangle^{AR_A} |\Phi_d\rangle^{BR_B}$, Alice can communicate $K(U)$ bits of classical information to Bob. Because of the symmetry, Bob can also communicate $K(U)$ bits to Alice. Since the classical communication power cannot exceed the classical communication cost, we have $C^\rightarrow, C^\leftarrow \geq K(U)$.

The proof is based on the protocol proposed in [36]. Suppose that Alice and Bob initially share $|\Phi_d\rangle^{AB_2} |\Phi_d\rangle^{BB_1}$. Let $\{\sigma_i^A\}_{i=1}^{d^2}$ be the set of unitaries on A satisfying $d^{-1}\text{Tr}[\sigma_i^\dagger \sigma_j] = \delta_{ij}$. (For example, we can take the set of generalized Pauli operators on A .) Alice sends the message i with the probability $p_i = 1/d^2$ by performing σ_i^A and then applying U^{AB} . The state after these two operations is

$$\begin{aligned} |\Psi_i\rangle &= U^{AB} \sigma_i^A |\Phi_d\rangle^{AB_2} |\Phi_d\rangle^{BB_1} \\ &= U^{AB} (\sigma_i^T)^{B_2} |\Phi_d\rangle^{AB_2} |\Phi_d\rangle^{BB_1}. \end{aligned}$$

The entropy of the reduced state on Bob's systems is

$$S(BB_1B_2)_{\Psi_i} = S(A)_{\Psi_i} = \log d.$$

On the other hand, the average state on Bob's side is

$$\begin{aligned} \bar{\Psi}^{BB_1B_2} &= \frac{1}{d^2} \sum_{i=1}^{d^2} \text{Tr}_A [U^{AB} (\sigma_i^T)^{B_2} |\Phi_d\rangle^{AB_2} |\Phi_d\rangle^{BB_1}] \\ &= \frac{1}{d^2} I^{B_2} \otimes \text{Tr}_A [U^{AB} (I^A \otimes \Phi^{BB_1}) U^{\dagger AB}]. \end{aligned}$$

Thus the entropy of the state is

$$S(BB_1B_2)_{\bar{\Psi}} = S(B_2)_{\bar{\Psi}} + S(BB_1)_{\bar{\Psi}} = \log d + K(U).$$

The Holevo information [37], [38] is then given by

$$\begin{aligned} \chi(\{p_i, \Psi_i^{BB_1B_2}\}) &= S(BB_1B_2)_{\bar{\Psi}} - \frac{1}{d^2} \sum_{i=1}^{d^2} S(BB_1B_2)_{\Psi_i} \\ &= K(U). \end{aligned}$$

Hence Alice can communicate $K(U)$ bits of classical information to Bob per use of U^{AB} on $|\Phi_d\rangle^{AB_2} |\Phi_d\rangle^{BB_1}$. ■

V. SINGLE-SHOT PROTOCOLS

To derive an upper bound on the optimal rate of the entanglement cost and the classical communication costs in both direction, namely, to prove that a certain rate triplet $(R_E, C^\rightarrow, C^\leftarrow)$ is achievable, we need to prove the existence of a protocol by which we can achieve the rate triplet. In this paper, we consider three-turn protocols in which Alice first preforms a measurement on her system, sends the result to Bob, Bob performs a measurement on his system, sends the result to Alice, and then Alice performs an operation on her system. Without loss of generality, we assume that Alice's last operation is to apply an isometry.

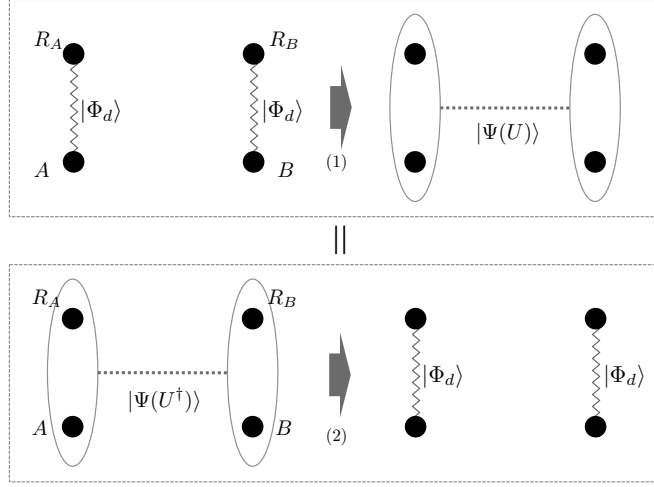

Fig. 2. The task of performing U^{AB} on $|\Phi_d\rangle^{AR_A}|\Phi_d\rangle^{BR_B}$ represented by the process (1) is equivalent to transforming $|\Psi(U^\dagger)\rangle$ into $|\Phi_d\rangle^{AR_A}|\Phi_d\rangle^{BR_B}$ represented by the process (2). This equivalencies due to the fact that R_A and R_B are reference systems that are inaccessible and invisible to Alice and Bob.

In this section, we consider single-shot protocols for applying U^{AB} on $|\Phi_d\rangle^{AR_A}|\Phi_d\rangle^{BR_B}$ by three-turn EALOCC. We derive conditions on Alice's first measurement for the protocol to succeed in high fidelity. The results obtained here are then applied to the asymptotic case in the next section.

Since R_A and R_B are reference systems that Alice and Bob cannot access, we can take any pure state on ABR_AR_B for the initial state, as long as it is a d -dimensional maximally entangled state between AB and R_AR_B . Indeed, if a quantum operation \mathcal{E} on AB satisfies $\mathcal{E}^{AB}(|\Phi_d\rangle^{AR_A}|\Phi_d\rangle^{BR_B}) = U^{AB}|\Phi_d\rangle^{AR_A}|\Phi_d\rangle^{BR_B}$, it also satisfies $\mathcal{E}^{AB}(U_0^{AB}|\Phi_d\rangle^{AR_A}|\Phi_d\rangle^{BR_B}) = (UU_0)^{AB}|\Phi_d\rangle^{AR_A}|\Phi_d\rangle^{BR_B}$ for any U_0 . In particular, we can take U_0 to be U^\dagger . Thus the task of applying U^{AB} on $|\Phi_d\rangle^{AR_A}|\Phi_d\rangle^{BR_B}$ is equivalent to transforming $|\Psi(U^\dagger)\rangle^{ABR_AR_B} := U^{\dagger AB}|\Phi_d\rangle^{AR_A}|\Phi_d\rangle^{BR_B}$ into $|\Phi_d\rangle^{AR_A}|\Phi_d\rangle^{BR_B}$ (Fig. 2). Observe that both $|\Psi(U^\dagger)\rangle$ and $|\Phi_d\rangle|\Phi_d\rangle$ are d^2 -dimensional maximally entangled state between AB and R_AR_B . While $|\Phi_d\rangle|\Phi_d\rangle$ obviously has no correlation between AR_A and BR_B , $|\Psi(U^\dagger)\rangle$ has some amount of entanglement depending on U^\dagger . Thus, for a given initial state $|\Psi(U^\dagger)\rangle^{ABR_AR_B}$, Alice and Bob need to decouple AR_A and BR_B while preserving the maximal entanglement between AB and R_AR_B .

Consider a three-turn EALOCC protocols for transforming $|\Psi(U^\dagger)\rangle^{ABR_AR_B}$ into $|\Phi_d\rangle^{AR_A}|\Phi_d\rangle^{BR_B}$ by using the resource state $|\phi_{\text{res}}\rangle^{A_0B_0}$. Since Alice's last operation does not change the reduced state of BR_BR_A , $|\Phi_d\rangle^{BR_B}$ must be obtained after Bob's operation. In order that this is possible, Alice's first measurement should be such that AR_A and R_B is decoupled for all measurement outcomes. Conversely, if Alice's measurement satisfies this condition, Bob can obtain $|\Phi_d\rangle^{BR_B}$ by performing an isometry on his system depending on her measurement outcome. To be precise, we have the following lemmas.

Lemma 4 Let $\mathcal{M} : AA_0 \otimes BB_0 \rightarrow AA_1 \otimes BB_1$ be an LOCC such that

$$F(\rho(\mathcal{M}), |\Psi(U)\rangle) \geq 1 - \epsilon, \quad (4)$$

where $\rho(\mathcal{M}) := \text{Tr}_{A_1B_1}[\mathcal{M}(|\Phi_d\rangle^{AR_A}|\Phi_d\rangle^{BR_B}|\phi_{\text{res}}\rangle^{A_0B_0})]$ and ϕ_{res} is a pure resource state shared in advance. Suppose \mathcal{M} is a three-turn protocol that starts with Alice's measurement described by measurement operators $\{M_k^{AA_0 \rightarrow A'}\}_{k=1}^K$. Let $p_k = \|M_k^{AA_0 \rightarrow A'}|\Psi(U^\dagger)\rangle|\phi_{\text{res}}\rangle\|_1^2$ and $|\Psi_k(U^\dagger)\rangle = p_k^{-1/2}M_k^{AA_0 \rightarrow A'}|\Psi(U^\dagger)\rangle|\phi_{\text{res}}\rangle$. Then

$$\sum_{k=1}^K p_k \left\| \Psi_k(U^\dagger)^{A'R_AR_B} - \Psi_k(U^\dagger)^{A'R_A} \otimes \frac{1}{d}I^{R_B} \right\|_1 \leq 4\sqrt{\epsilon}. \quad (5)$$

Proof: The condition (4) is equivalent to

$$F(\rho(\mathcal{M}, U^\dagger)^{ABR_AR_B}, |\Phi_d\rangle^{AR_A}|\Phi_d\rangle^{BR_B}) \geq 1 - \epsilon,$$

where $\rho(\mathcal{M}, U^\dagger) := \text{Tr}_{A_1B_1}[\mathcal{M}(|\Psi(U^\dagger)\rangle^{AR_ABR_B}|\phi_{\text{res}}\rangle^{A_0B_0})]$. Let $\{N_l^{(k)BB_0 \rightarrow BB_1}\}_{l=1}^L$ be measurement operators of Bob's measurement. We assume that Alice's second operation is an isometry $V^{(kl)A' \rightarrow AA_1}$. Define $p_{kl} = \|(M_k \otimes$

$N_l^{(k)}|\Psi(U^\dagger)\rangle|\phi_{\text{res}}\rangle\|_1^2$, $|\Psi_{kl}(U^\dagger)\rangle = p_{kl}^{-1/2}(M_k \otimes N_l^{(k)})|\Psi(U^\dagger)\rangle|\phi_{\text{res}}\rangle$ and $|\Psi'_{kl}(U^\dagger)\rangle = V^{(kl)}|\Psi_{kl}(U^\dagger)\rangle$. From (4), we have

$$\begin{aligned} 1 - \epsilon &\leq \sum_{kl} p_{kl} F(|\Psi'_{kl}(U^\dagger)\rangle^{ABR_A R_B}, |\Phi_d\rangle^{ARA} |\Phi_d\rangle^{BRB}) \\ &= \sum_{kl} p_{kl} F(|\Psi'_{kl}(U^\dagger)\rangle, |\Phi_d\rangle^{ARA} |\Phi_d\rangle^{BRB} |\phi_{kl}\rangle^{A_1 B_1}) \end{aligned}$$

for some states ϕ_{kl} . Using the relation $\|\rho - \sigma\|_1 \leq 2\sqrt{1 - F(\rho, \sigma)}$ and the convexity of the trace distance, we obtain

$$\begin{aligned} 2\sqrt{\epsilon} &\geq \sum_{kl} p_{kl} \left\| |\Psi'_{kl}(U^\dagger)\rangle - \Phi_d^{ARA} \otimes \Phi_d^{BRB} \otimes \phi_{kl}^{A_1 B_1} \right\|_1 \\ &= \sum_{kl} p_{kl} \left\| |\Psi_{kl}(U^\dagger)\rangle^{A' R_A B B_0 R_B} - V^{(kl)}(\Phi_d^{ARA} \otimes \Phi_d^{BRB} \otimes \phi_{kl}^{A_1 B_1}) V^{(kl)\dagger} \right\|_1 \\ &\geq \sum_{kl} p_{kl} \left\| |\Psi_{kl}(U^\dagger)\rangle^{A' R_A R_B} - V^{(kl)}(\Phi_d^{ARA} \otimes \phi_{kl}^{A_1}) V^{(kl)\dagger} \otimes \frac{1}{d} I^{R_B} \right\|_1 \\ &\geq \sum_k p_k \left\| \sum_l p_{l|k} |\Psi_{kl}(U^\dagger)\rangle^{A' R_A R_B} - \psi_k^{A' R_A} \otimes \frac{1}{d} I^{R_B} \right\|_1. \end{aligned}$$

Here we defined $\psi_k := \sum_l p_{l|k} V^{(kl)}(\Phi_d^{ARA} \otimes \phi_{kl}^{A_1}) V^{(kl)\dagger}$. Observe that

$$\sum_l p_{l|k} |\Psi_{kl}(U^\dagger)\rangle = \frac{1}{p_k} \sum_l (M_k \otimes N_l^{(k)}) (\Psi(U^\dagger) \otimes \phi_{\text{res}}) (M_k \otimes N_l^{(k)})^\dagger$$

and, since $\mathcal{N} : \rho \rightarrow \sum_{l=1}^L N_l^{(k)} \rho N_l^{(k)\dagger}$ is a CPTP map on BB_0 ,

$$\sum_l p_{l|k} |\Psi_{kl}(U^\dagger)\rangle^{A' R_A R_B} = \Psi_k(U^\dagger)^{A' R_A R_B}.$$

Hence we obtain

$$\begin{aligned} 2\sqrt{\epsilon} &\geq \sum_k p_k \left\| \Psi_k(U^\dagger)^{A' R_A R_B} - \psi_k^{A' R_A} \otimes \frac{1}{d} I^{R_B} \right\|_1 \\ &\geq \sum_k p_k \left\| \Psi_k(U^\dagger)^{A' R_A} - \psi_k^{A' R_A} \right\|_1 \\ &= \sum_k p_k \left\| \Psi_k(U^\dagger)^{A' R_A} \otimes \frac{1}{d} I^{R_B} - \psi_k^{A' R_A} \otimes \frac{1}{d} I^{R_B} \right\|_1 \end{aligned}$$

By the triangle inequality, we obtain

$$\begin{aligned} 4\sqrt{\epsilon} &\geq \sum_k p_k \left\| \Psi_k(U^\dagger)^{A' R_A R_B} - \psi_k^{A' R_A} \otimes \frac{1}{d} I^{R_B} \right\|_1 + \sum_k p_k \left\| \Psi_k(U^\dagger)^{A' R_A} \otimes \frac{1}{d} I^{R_B} - \psi_k^{A' R_A} \otimes \frac{1}{d} I^{R_B} \right\|_1 \\ &\geq \sum_{k=1}^K p_k \left\| \Psi_k(U^\dagger)^{A' R_A R_B} - \Psi_k(U^\dagger)^{A' R_A} \otimes \frac{1}{d} I^{R_B} \right\|_1. \end{aligned}$$

■

Lemma 5 If (5) is satisfied and $|\Psi_k^p(U^\dagger)\rangle^{A' R_A B_0}$ is a purification of $\Psi_k(U^\dagger)^{A' R_A}$, there exists a set of unitaries $\{W^{(k)}\}_{k=1}^K$ on BB_0 such that

$$\sum_{k=1}^K p_k \left\| W^{(k)} \Psi_k(U^\dagger)^{A' R_A B_0 B R_B} W^{(k)\dagger} - \Psi_k^p(U^\dagger)^{A' R_A B_0} \otimes \Phi_d^{BRB} \right\|_1 \leq 4\sqrt{\epsilon}.$$

Proof: It is straightforward from Uhlmann's theorem [39], [40]. See Lemma 2.2 in [2] and Proposition 3 in [5]. ■

Example. To illustrate the implications of Lemma 4 and Lemma 5, we consider a protocol for performing two-qubit controlled-phase gate exactly and deterministically by EALOCC, which is proposed in [19]. Let $U = |0\rangle\langle 0| \otimes I + |1\rangle\langle 1| \otimes e^{i\varphi Z}$. The protocol for implementing this unitary is equivalent to the protocol depicted in Fig. 3. In this case $|\phi_{\text{res}}\rangle = (|00\rangle + |11\rangle)/\sqrt{2}$,

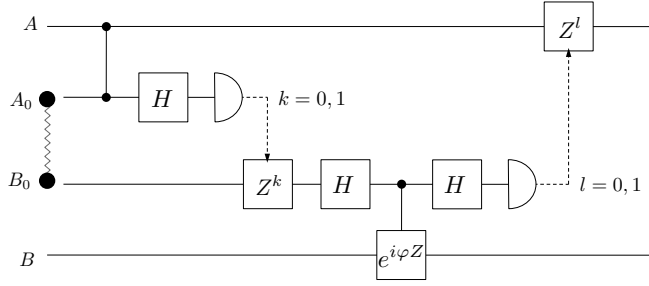

Fig. 3. The protocol for implementing controlled-phase gate proposed in [19]. H denotes the Hadamard gate and the measurements are performed with the computational basis.

$A' = A$, $p_k = 1/2$ ($k = 1, 2$) and $M_k^{AA_0 \rightarrow A} = \langle 0|^{A_0} \otimes I^A \pm \langle 1|^{A_0} \otimes Z^A$, where $+$ and $-$ corresponds to $k = 1$ and 2 , respectively. We have

$$\begin{aligned} |\Psi(U^\dagger)\rangle &= \frac{1}{2}(|00\rangle + e^{+i\varphi}|11\rangle)^{AR_A} |00\rangle^{BR_B} + \frac{1}{2}(|00\rangle + e^{-i\varphi}|11\rangle)^{AR_A} |11\rangle^{BR_B} \\ &=: \frac{1}{\sqrt{2}}|\Phi_{+\varphi}\rangle^{AR_A} |00\rangle^{BR_B} + \frac{1}{\sqrt{2}}|\Phi_{-\varphi}\rangle^{AR_A} |11\rangle^{BR_B} \end{aligned}$$

and, in particular, we have

$$\Psi(U^\dagger)^{AR_A RB} = \frac{1}{2}\Phi_{+\varphi}^{AR_A} \otimes |0\rangle\langle 0|^{RB} + \frac{1}{2}\Phi_{-\varphi}^{AR_A} \otimes |1\rangle\langle 1|^{RB}.$$

By using $\phi_{\text{res}}^{A_0} = I/2$, we obtain

$$\begin{aligned} \Psi_k(U^\dagger)^{AR_A RB} &= p_k^{-1} \text{Tr}_{BB_0} [M_k |\Psi(U^\dagger)\rangle |\phi_{\text{res}}\rangle] \\ &= p_k^{-1} M_k \left(\Psi(U^\dagger)^{AR_A RB} \otimes \frac{1}{2} I^{A_0} \right) M_k^\dagger \\ &= \mathcal{T}_{\text{deph}}^A (\Psi(U^\dagger)^{AR_A RB}), \end{aligned}$$

where $\mathcal{T}_{\text{deph}}^A$ is the dephasing channel on A defined as

$$\mathcal{T}_{\text{deph}}^A(\rho) = \frac{1}{2}(\rho + Z\rho Z).$$

Since

$$\mathcal{T}_{\text{deph}}^A(\Phi_{+\varphi}^{AR_A}) = \mathcal{T}_{\text{deph}}^A(\Phi_{-\varphi}^{AR_A}) = \frac{1}{2}(|00\rangle\langle 00| + |11\rangle\langle 11|),$$

we have

$$\mathcal{T}_{\text{deph}}^A(\Psi(U^\dagger)^{AR_A RB}) = \frac{1}{2}(|00\rangle\langle 00| + |11\rangle\langle 11|)^{AR_A} \otimes \frac{1}{2} I^{RB}.$$

Thus $\Psi_k(U^\dagger)$ ($k = 1, 2$) satisfies the condition (5) with $\epsilon = 0$.

Alice's measurement operation described by M_k with ϕ_{res} is equivalent to performing the controlled-Z gate on B_0A with B_0 initially prepared in the state $|+\rangle = (|0\rangle + |1\rangle)/\sqrt{2}$, up to phases on B_0 . Indeed, we have

$$M_k |\phi_{\text{res}}\rangle = |0\rangle^{B_0} \otimes I^A \pm |1\rangle^{B_0} \otimes Z^A \quad (k = 1, 2).$$

The one bit classical communication from Alice to Bob and the following Z gate on B_0 eliminate the phase that depends on the measurement outcome. Bob then applies a unitary on B_0B to obtain $|\Psi^P(U^\dagger)\rangle^{AR_A B_0} |\Phi_2\rangle^{BR_B}$, where $|\Psi^P(U^\dagger)\rangle$ is a purification of $\Psi_k(U^\dagger)^{AR_A}$. In the remaining part of the protocol, Alice and Bob obtain $\Phi_2^{AR_A}$ from $|\Psi^P(U^\dagger)\rangle^{AR_A B_0}$.

VI. UPPER BOUND

Let us return to the asymptotic case. We consider a protocol where $L_n = 1$, that is, no entanglement is left after the protocol. We denote A^n as \bar{A} and B^n as \bar{B} , and so on. The task is to apply a unitary $(U^{AB})^{\otimes n}$ on $(|\Phi_d\rangle^{AR_A} |\Phi_d\rangle^{BR_B})^{\otimes n}$ by using $|\Phi_{K_n}\rangle^{A_0 B_0}$ as a resource, or, equivalently, to transform $|\Psi(U^\dagger)^{\otimes n}\rangle^{\bar{A}\bar{B}\bar{R}_A\bar{R}_B} |\Phi_{K_n}\rangle^{A_0 B_0}$ into $|\Phi_d^{\otimes n}\rangle^{\bar{A}\bar{R}_A} |\Phi_d^{\otimes n}\rangle^{\bar{B}\bar{R}_B}$. For this task, we construct a protocol consisting of two processes (Fig. 4). In the 'forward process' aiming at obtaining $|\Phi_d^{\otimes n}\rangle^{\bar{A}\bar{R}_A}$ from $|\Psi(U^\dagger)\rangle^{\otimes n} |\Phi_{K_n}\rangle^{A_0 B_0}$, Alice performs a measurement on her system, sends the result to Bob, and Bob applies a unitary on his system. It is followed by the 'backward process' consisting of quantum state merging from Bob to Alice, aiming at

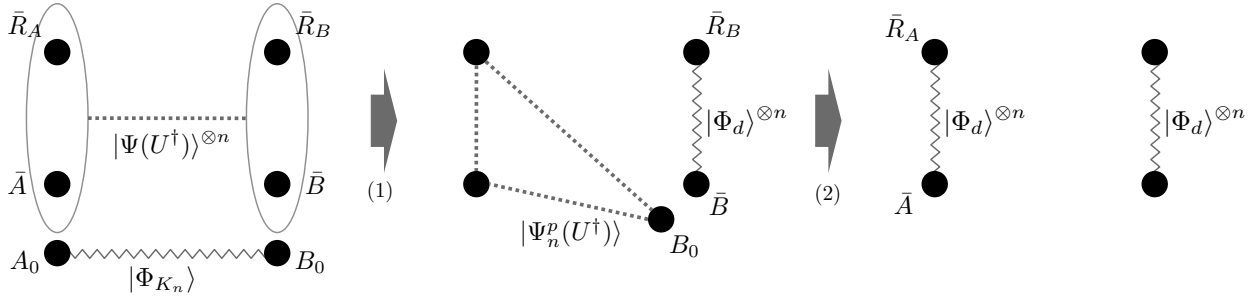

Fig. 4. We consider a three-turn EALOCC protocol for implementing $U^{\otimes n}$ on $|\Phi_d^{\otimes n}\rangle^{\bar{A}\bar{R}_A}|\Phi_d^{\otimes n}\rangle^{\bar{B}\bar{R}_B}$. (1) In the ‘forward process’, Alice and Bob recover $|\Phi_d^{\otimes n}\rangle^{\bar{B}\bar{R}_B}$ from $|\Psi(U^\dagger)\rangle^{\otimes n, \bar{A}\bar{B}\bar{R}_A\bar{R}_B}$ by using a resource state $|\Phi_{K_n}\rangle^{A_0 B_0}$. (2) After that, they recover $|\Phi_d^{\otimes n}\rangle^{\bar{A}\bar{R}_A}$ by performing quantum state merging from Bob to Alice. The entanglement cost in step (2) is negligible in the asymptotic limit.

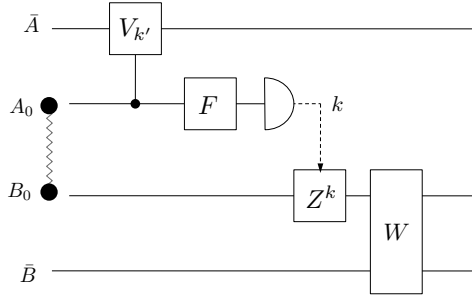

Fig. 5. As the ‘forward process’, we consider a protocol similar to the first half of the protocol presented in Fig. 3. F denotes the Fourier transform and Z is the phase gate. The measurement is performed with the computational basis. This scheme is similar to the protocol proposed in [27].

obtaining $|\Phi_d^{A\bar{R}_A}\rangle^{\otimes n}$. From the result in the previous section, Alice’s measurement must be such that $\bar{A}\bar{R}_A$ and \bar{R}_B is almost decoupled for all measurement outcomes. Also, if the decoupling succeeds in high fidelity, Bob can obtain $|\Phi_d^{B\bar{R}_B}\rangle^{\otimes n}$ by applying a unitary on his system depending on Alice’s measurement outcome.

As the forward process, we consider a protocol consisting of the following steps (Fig. 5).

- 1) Alice applies a controlled-unitary gate of the form $\tilde{V}^{\bar{A}A_0} = \sum_{k'=1}^{K_n} |k'\rangle\langle k'|^{A_0} \otimes V_{k'}^{\bar{A}}$.
- 2) Alice applies a Fourier transform $F = \frac{1}{\sqrt{K_n}} \sum_{kk'} e^{2\pi i k k' / K_n} |k\rangle\langle k'|$ on A_0 .
- 3) Alice performs a projective measurement on A_0 with the basis $\{|k\rangle\}_{k=1}^{K_n}$.
- 4) Alice sends the measurement result k to Bob. This requires $\log K_n$ bits of forward classical communication.
- 5) Bob applies a phase gate Z^k on B_0 . Here, $Z = \sum_{k'=1}^{K_n} e^{-2\pi i k k' / K_n} |k'\rangle\langle k'|$.
- 6) Bob applies a unitary $W^{\bar{B}B_0}$.

The total action of the five steps is equivalent to applying a controlled-unitary gate $\tilde{V}^{\bar{A}B_0} = \sum_{k'=1}^{K_n} |k'\rangle\langle k'|^{B_0} \otimes V_{k'}^{\bar{A}}$ with B_0 initially prepared in the state $|+_{K_n}\rangle := \frac{1}{\sqrt{K_n}} \sum_{k'=1}^{K_n} |k'\rangle$. Thus, regardless of the measurement outcome k , the state after step 5 is given by

$$|\Psi_n^5(U^\dagger)\rangle^{\bar{A}\bar{B}B_0\bar{R}_A\bar{R}_B} := \frac{1}{\sqrt{K_n}} \sum_{k'=1}^{K_n} |k'\rangle^{B_0} \otimes V_{k'}^{\bar{A}} |\Psi(U^\dagger)\rangle^{\otimes n, \bar{A}\bar{B}\bar{R}_A\bar{R}_B}.$$

In particular, its reduced state on $\bar{A}\bar{R}_A\bar{R}_B$ is given by

$$\Psi_n^5(U^\dagger)^{\bar{A}\bar{R}_A\bar{R}_B} = \frac{1}{K_n} \sum_{k'=1}^{K_n} V_{k'}^{\bar{A}} (\Psi(U^\dagger)^{\otimes n})^{\bar{A}\bar{R}_A\bar{R}_B} V_{k'}^{\dagger \bar{A}}. \quad (6)$$

From Lemma 5, if

$$\Psi_n^5(U^\dagger)^{\bar{A}\bar{R}_A\bar{R}_B} \approx \Psi_n^5(U^\dagger)^{\bar{A}\bar{R}_A} \otimes \frac{1}{d^n} I^{\bar{R}_B}, \quad (7)$$

and $|\Psi_n^p(U^\dagger)\rangle^{\bar{A}B_0\bar{R}_A}$ is a purification of $\Psi_n^5(U^\dagger)^{\bar{A}\bar{R}_A}$, there exists a unitary W on $\bar{B}B_0$ such that $W|\Psi_n^5(U^\dagger)\rangle^{\bar{A}\bar{B}B_0\bar{R}_A\bar{R}_B} \approx |\Psi_n^p(U^\dagger)\rangle^{\bar{A}B_0\bar{R}_A} |\Phi_d^{\otimes n}\rangle^{\bar{B}\bar{R}_B}$ (Fig. 6). Thus Bob can obtain $|\Phi_d^{\otimes n}\rangle^{\bar{B}\bar{R}_B}$. Both the entanglement cost and the classical communication in this process is equal to $\log K_n$.

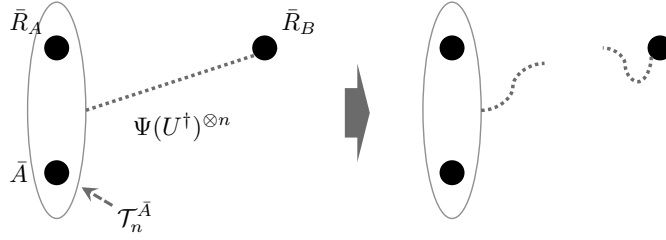

Fig. 6. When we only consider $\bar{A}\bar{R}_A\bar{R}_B$, the action of the five steps in the forward process is equal to performing $\mathcal{T}_n^{\bar{A}}$ on \bar{A} . Here, $\mathcal{T}_n^{\bar{A}}$ is a random unitary operation defined as $\mathcal{T}_n^{\bar{A}} : \tau \mapsto 2^{-nR} \sum_{k=1}^{2^{nR}} V_k \tau V_k^\dagger$. The correlation between $\bar{A}\bar{R}_A$ and \bar{R}_B needs to be destroyed by this operation.

The remaining task is to recover $|\Phi_d^{\otimes n}\rangle^{\bar{A}\bar{R}_A}$ from $|\Psi_n^p(U^\dagger)\rangle^{\bar{A}B_0\bar{R}_A}$. Here we introduce quantum state merging [4], [5] in which Bob merges B_0 to Alice. If this process succeeds in high fidelity, Alice can obtain $|\Phi_d^{\otimes n}\rangle^{\bar{A}\bar{R}_A}$ by performing local isometry on her system. In the asymptotic limit of many copies, the entanglement cost per copy in quantum state merging is given by the quantum conditional entropy $S(B_0|\bar{A})_{\Psi_n^p(U^\dagger)}$, and the classical communication cost per copy is equal to the quantum mutual information $I(B_0 : \bar{R}_A)_{\Psi_n^p(U^\dagger)}$. As we show in detail below, since $S(B_0|\bar{A})_{\Psi_n^p(U^\dagger)} = 0$, the entanglement cost in this process is negligible. Also, the classical communication cost is equal to $I(B_0 : \bar{R}_A)_{\Psi_n^p(U^\dagger)} = \log K_n$. Thus the total amount of the entanglement cost, the forward and the backward communication cost per copy is $\frac{1}{n} \log K_n$. From (6) and (7), K_n is equal to the cost of randomness required for decoupling $\bar{A}\bar{R}_A$ and \bar{R}_B in the state $(\Psi(U^\dagger)^{\otimes n})^{\bar{A}\bar{R}_A\bar{R}_B}$ by a random unitary operation on \bar{A} .

To be precise, we have the following statements.

Definition 6 We say that $\Psi(U^\dagger)^{A R_A R_B}$ is decoupled between $A R_A$ and R_B with the randomness cost R if, for any $\epsilon > 0$ and for sufficiently large n , there exists a random unitary operation $\mathcal{T}_n^{\bar{A}} : \tau \mapsto 2^{-nR} \sum_{k=1}^{2^{nR}} V_k \tau V_k^\dagger$ on \bar{A} such that

$$\left\| \mathcal{T}_n^{\bar{A}}(\Psi(U^\dagger)^{\otimes n})^{\bar{A}\bar{R}_A\bar{R}_B} - \mathcal{T}_n^{\bar{A}}(\Psi(U^\dagger)^{\otimes n})^{\bar{A}\bar{R}_A} \otimes \frac{1}{d^n} I^{\bar{R}_B} \right\|_1 \leq \epsilon. \quad (8)$$

The partial decoupling cost of U is defined as $D(U) := \inf\{R \mid \Psi(U^\dagger)^{A R_A R_B} \text{ is decoupled between } A R_A \text{ and } R_B \text{ with the randomness cost } R\}$.

Theorem 7 A rate triplet $(R_E, C^\rightarrow, C^\leftarrow)$ is achievable if $R_E, C^\rightarrow, C^\leftarrow \geq D(U)$.

Proof: Take arbitrary $R > D(U)$ and let $K_n = 2^{nR}$. Fix arbitrary $\delta > 0$, choose sufficiently large m , let $\epsilon = \delta/m^2$ and choose sufficiently large n . Let $\mathcal{T}_n^{\bar{A}} : \tau \mapsto 2^{-nR} \sum_{k=1}^{2^{nR}} V_k \tau V_k^\dagger$ be a random unitary operation that satisfies (8). Using V_k , construct a controlled-unitary operator $\tilde{V}^{\bar{A}A_0} = \sum_{k'=1}^{K_n} |k'\rangle\langle k'|^{A_0} \otimes V_{k'}^{\bar{A}}$. Suppose that Alice and Bob performs the forward process. After step 5, the reduced state on $\bar{A}\bar{R}_A\bar{R}_B$, given by (6), is equal to $\mathcal{T}_n^{\bar{A}}(\Psi(U^\dagger)^{\otimes n})^{\bar{A}\bar{R}_A\bar{R}_B}$. thus it satisfies

$$\left\| \Psi_n^5(U^\dagger)^{\bar{A}\bar{R}_A\bar{R}_B} - \Psi_n^5(U^\dagger)^{\bar{A}\bar{R}_A} \otimes \frac{1}{d^n} I^{\bar{R}_B} \right\|_1 \leq \epsilon.$$

Hence, if $|\Psi_n^p(U^\dagger)\rangle^{\bar{A}\bar{R}_A B_0}$ is a purification of $\Psi_n^5(U^\dagger)^{\bar{A}\bar{R}_A}$, there exists a unitary W on $\bar{B}B_0$ such that

$$\left\| W \Psi_n^5(U^\dagger) W^\dagger - \Psi_n^p(U^\dagger)^{\bar{A}\bar{R}_A B_0} \otimes (\Phi_d^{\otimes n})^{\bar{B}\bar{R}_B} \right\|_1 \leq 2\sqrt{\epsilon}.$$

By applying W , Bob can obtain $|\Phi_d^{\otimes n}\rangle^{\bar{B}\bar{R}_B}$.

Suppose that Alice and Bob perform this protocol on each of m blocks of length n in $\Psi(U^\dagger)^{\otimes mn}$. Let $\Psi_{mn}^5(U^\dagger) := (\Psi_n^5(U^\dagger))^{\otimes m}$. In total, the state after step 5 satisfies

$$\left\| \Psi_{mn}^5(U^\dagger) - (\Psi_n^p(U^\dagger)^{\otimes m})^{\bar{A}^m \bar{R}_A^m B_0^m} \otimes (\Phi_d^{\otimes mn})^{\bar{B}^m \bar{R}_B^m} \right\|_1 \leq 2m\sqrt{\epsilon} = 2\sqrt{\delta}. \quad (9)$$

Now, consider quantum state merging of $|\Psi_n^p(U^\dagger)\rangle^{\bar{A}\bar{R}_A B_0}$ from Bob to Alice. Since $S(B_0|\bar{A}) = S(B_0\bar{A}) - S(\bar{A}) = S(\bar{R}_A) - S(\bar{A}) = n \log d - n \log d = 0$ for $\Psi_n^p(U^\dagger)$, there exists a merging protocol of $|\Psi_n^p(U^\dagger)^{\otimes m}\rangle^{\bar{A}^m \bar{R}_A^m B_0^m}$ with error δ and the entanglement cost $m\delta$. That is, there is an LOCC map \mathcal{E}' that implements $|\Psi_n^p(U^\dagger)^{\otimes m}\rangle^{\bar{A}^m B_0^m \bar{R}_A^m} |\Phi_{2m\delta}\rangle^{A'_0 B'_0} \rightarrow |\Psi_n^p(U^\dagger)^{\otimes m}\rangle^{\bar{A}^m \bar{A} \bar{R}_A^m}$ with the error δ . Here, A'_0, B'_0 and \hat{A} are additional registers. Let $O : \bar{A}^m \hat{A} \rightarrow \bar{A}^m$ be the isometry such that $O|\Psi_n^p(U^\dagger)^{\otimes m}\rangle^{\bar{A}^m \bar{R}_A^m \hat{A}} = |\Phi_d^{\otimes mn}\rangle^{\bar{A}^m \bar{R}_A^m}$. Combining \mathcal{E}' and O , we obtain an LOCC map $\mathcal{E} : \bar{A}^m B_0 A'_0 B'_0 \rightarrow \bar{A}^m$ such that

$$\left\| \mathcal{E} \left(|\Psi_n^p(U^\dagger)^{\otimes m}\rangle^{\bar{A}^m \bar{R}_A^m B_0} |\Phi_{2m\delta}\rangle^{A'_0 B'_0} \right) - (\Phi_d^{\otimes mn})^{\bar{A}^m \bar{R}_A^m} \right\|_1 \leq \delta. \quad (10)$$

Combining (9) and (10), the total error is given by

$$\left\| \mathcal{E}(|\Psi_{mn}^5(U^\dagger)\rangle|\Phi_{2m\delta}) - (\Phi_d^{\otimes mn})^{\bar{A}^m \bar{R}_A^m} \otimes (\Phi_d^{\otimes mn})^{\bar{B}^m \bar{R}_B^m} \right\|_1 \leq 2\sqrt{\delta} + \delta.$$

In total, the entanglement cost in this protocol is $m \log K_n + m\delta = mn(R + \delta/n)$. The forward classical communication cost, which is given by the number of Alice's measurement outcomes, is $m \log K_n = mnR$. The backward classical communication cost is equal to $m(I(\bar{R}_A : B_0)_{\Psi_n^p(U^\dagger)} + \delta) = m(S(B_0)_{\Psi_n^p(U^\dagger)} + \delta) = m(\log K_n + \delta) = mn(R + \delta/n)$ bits. Thus the rate triplet $(R_E = R, C^\rightarrow = R, C^\leftarrow = R)$ is achievable, and consequently, any rate triplet $(R_E, C^\rightarrow, C^\leftarrow)$ is achievable if $R_E, C^\rightarrow, C^\leftarrow \geq D(U)$. ■

Corollary 8 $D(U) \geq K(U)$.

Proof: Follows from Theorem 3 and Theorem 7. It can also be derived from Proposition 1 presented in [41]. ■

Obviously, $\Psi(U^\dagger)^{AR_A R_B}$ is decoupled between AR_A and R_B with the randomness cost $2 \log d$, because applying uniformly random generalized Pauli operators on \bar{A} decouples \bar{A} and all the other systems. Note that, since there is no correlation between \bar{R}_A and \bar{R}_B initially, decoupling \bar{A} and $\bar{R}_A \bar{R}_B$ is sufficient for decoupling $\bar{A} \bar{R}_A$ and \bar{R}_B . Thus we have $D(U) \leq 2 \log d$ and $(R_E, C^\rightarrow, C^\leftarrow)$ is achievable if $R_E, C^\rightarrow, C^\leftarrow \geq 2 \log d$. However, this bound is trivial since the resource cost $R_E, C^\rightarrow, C^\leftarrow = 2 \log d$ is achievable through the protocol in which Alice teleports her system to Bob, Bob applies the unitary, and teleports Alice's system back to her.

In analogy with the decoupling theorem for bipartite quantum states [11]–[13], [41], we might expect that the random coding method with respect to the Haar distributed unitary ensembles on \bar{A} is sufficient to derive $D(U)$. However, this is not the case. If we apply the Haar distributed random unitary on \bar{A} , not only the correlation between $\bar{A} \bar{R}_A$ and \bar{R}_B but also the correlation between \bar{A} and \bar{R}_A is destroyed. Thus part of the total randomness is wastefully consumed for decoupling \bar{A} and \bar{R}_A . In particular, if $K(U)$ is much small and the correlation between \bar{A} and \bar{R}_A is strong, much large amount of the randomness is wastefully consumed. To reduce the randomness cost, we need to find a random unitary operation on \bar{A} which selectively decouples $\bar{A} \bar{R}_A$ and \bar{R}_B without much destroying the correlation between \bar{A} and \bar{R}_A .

We have not found how to calculate $D(U)$ in general, except for a particular class of bipartite unitaries which is discussed in the next section.

VII. GENERALIZED CLIFFORD OPERATORS

In this section, we prove that $K(U_{Cl}) = D(U_{Cl})$ for generalized Clifford operators U_{Cl} , and thus the optimal entanglement cost, the forward and the backward classical communication cost per input pair is equal to $K(U_{Cl})$.

The generalized Pauli operators on d -dimensional Hilbert space is defined as $\sigma_{pq} := X^p Z^q$, where $X := \sum_{t=1}^d |t-1\rangle\langle t|$ and $Z := \sum_{t=1}^d e^{2\pi i t/d} |t\rangle\langle t|$ with a fixed basis $\{|t\rangle\}_{t=1}^d$. Here, subtraction is taken with mod d . A unitary U on two d -dimensional Hilbert space $\mathcal{H}_A \otimes \mathcal{H}_B$ is called a generalized Clifford operator if, for any p, q, r and s , there exist p', q', r' and s' such that $U(\sigma_{pq} \otimes \sigma_{rs})U^\dagger = \sigma_{p'q'} \otimes \sigma_{r's'}$.

The idea of the proof is as follows. Although R_B is a reference system that Alice and Bob cannot access, for the moment imagine that we can apply a random unitary operation on R_B . In particular, suppose that we can randomly apply generalized Pauli operators σ_{pq}^T with the uniform distribution. Because of Schur's lemma, the random Pauli operation decouples AR_A and R_B . In the asymptotic limit of many copies of $\Psi(U^\dagger)$, the number of Pauli operators required to decouple AR_A and R_B is equal to $I(AR_A : R_B)_{\Psi(U^\dagger)} = K(U)$ per copy. But due to the commutation relation of generalized Pauli and Clifford operators, we can replace σ_{pq}^T on R_B by $\sigma_{p'q'} \otimes \sigma_{r's'}$ on AB . In particular, for the state $\Psi(U^\dagger)^{AR_A R_B}$, applying σ_{pq}^T on R_B is equivalent to applying $\sigma_{p'q'}$ on A . Thus the random Pauli operation on R_B is exactly substituted by a random Pauli operation on A . Hence the number of random Pauli operators on A that we need to decouple AR_A and R_B is at most $I(AR_A : R_B)_{\Psi(U^\dagger)} = K(U)$ per copy. We show the rigorous proof below.

Lemma 9 (Proposition 2 in [41]) For any $\rho^{AB} \in \mathcal{S}(\mathcal{H}^A \otimes \mathcal{H}^B)$ and $\epsilon > 0$, there exists n_0 such that for all $n \geq n_0$ the following holds. Let $\mathcal{H}_{n,\epsilon}^{A_{typ}}$ be the ϵ -typical subspace of $(\rho^A)^{\otimes n}$ and let $\Pi_{n,\epsilon}^{A_{typ}}$ be the projection onto $\mathcal{H}_{n,\epsilon}^{A_{typ}}$. Also let $\{p(dV), V\}$ be an ensemble of unitaries on $\mathcal{H}_{n,\epsilon}^{A_{typ}}$ such that for all $|\phi\rangle \in \mathcal{H}_{n,\epsilon}^{A_{typ}}$,

$$\int_V p(dV) V |\phi\rangle\langle\phi| V^\dagger = \frac{\Pi_{n,\epsilon}^{A_{typ}}}{\text{Tr} \Pi_{n,\epsilon}^{A_{typ}}}.$$

Then, if $R \geq I(A : B)_\rho + \epsilon$, there exists a set of unitaries $\{V_k\}_{k=1}^{2^{nR}}$ on the support of $p(dV)$ such that

$$\left\| \frac{1}{2^{nR}} \sum_{k=1}^{2^{nR}} V_k (\rho^{AB})^{\otimes n} V_k^\dagger - \frac{\Pi_{n,\epsilon}^{A_{typ}}}{\text{Tr} \Pi_{n,\epsilon}^{A_{typ}}} \otimes (\rho^B)^{\otimes n} \right\|_1 \leq 5\epsilon + 8\sqrt{\epsilon}.$$

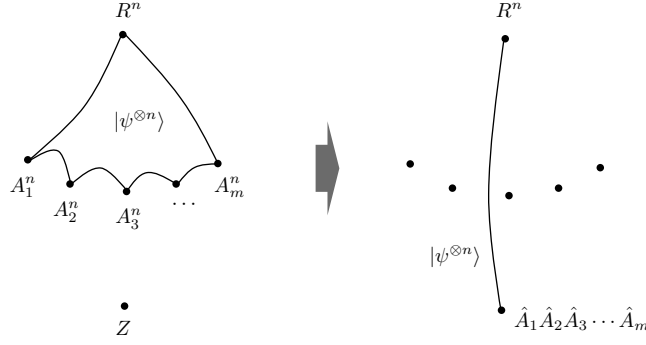

Fig. 7. In the distributed compression of m -partite quantum state, m senders transfer their share of a quantum state to a receiver Z , who has quantum systems $\hat{A}_1 \hat{A}_2 \hat{A}_3 \cdots \hat{A}_m$ isomorphic to $A_1^n A_2^n A_3^n \cdots A_m^n$. The m senders are not allowed to communicate with each other.

Theorem 10 $K(U_{\text{Cl}}) = D(U_{\text{Cl}})$.

Proof: Fix arbitrary $\epsilon > 0$ and choose sufficiently large n . Let $\sigma_{\bar{p}\bar{q}} := \sigma_{p_1 q_1} \otimes \cdots \otimes \sigma_{p_n q_n}$ be tensor products of generalized Pauli operators on $R_B^{\otimes n} = \bar{R}_B$. Consider an ensemble of unitaries $\{\frac{1}{d^{2n}}, \sigma_{\bar{p}\bar{q}}\}_{\bar{p}\bar{q}}$. Since $\Psi(U^\dagger)^{R_B} = \frac{1}{d} I^{R_B}$, $\sigma_{\bar{p}\bar{q}}$ is a unitary on the typical subspace of $(\Psi(U^\dagger)^{\otimes n})^{\bar{R}_B}$. Because of Schur's lemma, the ensemble satisfies

$$\frac{1}{d^{2n}} \sum_{\bar{p}\bar{q}} \sigma_{\bar{p}\bar{q}}^{\bar{R}_B} |\phi\rangle\langle\phi|^{\bar{R}_B} \sigma_{\bar{p}\bar{q}}^{\dagger \bar{R}_B} = \frac{1}{d^n} I^{\bar{R}_B}.$$

Thus, from Lemma 9, if $R \geq I(AR_A : R_B)_{\Psi(U^\dagger)} + \epsilon = K(U) + \epsilon$, there exists a set of unitaries $\{\sigma_{\bar{p}_k \bar{q}_k}\}_{k=1}^{2^{nR}}$ on \bar{R}_B such that

$$\left\| \frac{1}{2^{nR}} \sum_{k=1}^{2^{nR}} \sigma_{\bar{p}_k \bar{q}_k}^{\bar{R}_B} (\Psi(U^\dagger)^{\otimes n})^{\bar{A}\bar{R}_A \bar{R}_B} \sigma_{\bar{p}_k \bar{q}_k}^{\dagger \bar{R}_B} - (\Psi(U^\dagger)^{\otimes n})^{\bar{A}\bar{R}_A} \otimes \frac{1}{d^n} I^{\bar{R}_B} \right\|_1 \leq 5\epsilon + 8\sqrt{\epsilon}.$$

When U is a generalized Clifford operator, we have

$$\begin{aligned} \sigma_{pq}^{R_B} |\Psi(U^\dagger)\rangle^{ABR_A R_B} &= (U^{\dagger AB} \otimes \sigma_{pq}^{R_B}) |\Phi_d\rangle^{AR_A} |\Phi_d\rangle^{BR_B} \\ &= e^{i\theta_{pq}} U^{\dagger AB} (I^A \otimes \sigma_{pq}^B) |\Phi_d\rangle^{AR_A} |\Phi_d\rangle^{BR_B} \\ &= e^{i\theta_{pq}} (\sigma_{p'q'}^A \otimes \sigma_{r's'}^B) U^{\dagger AB} |\Phi_d\rangle^{AR_A} |\Phi_d\rangle^{BR_B} \\ &= e^{i\theta_{pq}} (\sigma_{p'q'}^A \otimes \sigma_{r's'}^B) |\Psi(U^\dagger)\rangle^{ABR_A R_B}. \end{aligned}$$

The third line follows from $\sigma_{pq}^{R_B} |\Phi_d\rangle^{BR_B} = (\sigma_{pq}^T)^B |\Phi_d\rangle^{BR_B} = e^{i\theta_{pq}} \sigma_{pq}^B |\Phi_d\rangle^{BR_B}$. In particular, we have

$$\sigma_{pq}^{R_B} \Psi(U^\dagger)^{AR_A R_B} \sigma_{pq}^{\dagger R_B} = \sigma_{p'q'}^A \Psi(U^\dagger)^{AR_A R_B} \sigma_{p'q'}^{\dagger A}.$$

Thus, for the state $\Psi(U^\dagger)^{AR_A R_B}$, applying $\sigma_{pq}^{R_B}$ is equivalent to applying $\sigma_{p'q'}^A$. For the same reason, for $(\Psi(U^\dagger)^{\otimes n})^{\bar{A}\bar{R}_A \bar{R}_B}$, applying $\sigma_{\bar{p}_k \bar{q}_k}^{\bar{R}_B}$ is equivalent to applying $\sigma_{\bar{p}'_k \bar{q}'_k}^{\bar{A}}$. Thus $\Psi(U^\dagger)^{AR_A R_B}$ is decoupled between AR_A and R_B with the randomness cost $K(U) + \epsilon$. That is, we have $D(U) \leq K(U)$. From Corollary 8, we have $K(U_{\text{Cl}}) = D(U_{\text{Cl}})$. ■

Corollary 11 For generalized Clifford operators U_{Cl} , a rate triplet $(R_E, C^\rightarrow, C^\leftarrow)$ is achievable if and only if $R_E, C^\rightarrow, C^\leftarrow \geq K(U_{\text{Cl}})$.

Proof: Follows from Theorem 3, Theorem 7 and Theorem 10. ■

VIII. DISTRIBUTED COMPRESSION

Distributed compression of quantum states is a task in which many parties transfer a shared state to a receiver, by using as small amount of quantum communication from each party to the receiver as possible, but with no communication among senders. Distributed compression of bipartite states is analyzed in [6], [30], and multipartite cases are formulated and considered in [31]. In distributed compression of m -partite quantum state, m parties A_1, \dots, A_m initially share n identical copies of a state $|\psi\rangle^{A_1 \cdots A_m R}$ with an inaccessible reference system R (Fig. 7). The objective is to transfer all the senders' shares of $(|\psi\rangle^{A_1 \cdots A_m R})^{\otimes n}$ to a receiver Z without destroying entanglement with the reference system. It is desirable that the total amount of quantum communication is as small as possible. We are interested in finding out the set of quantum communication

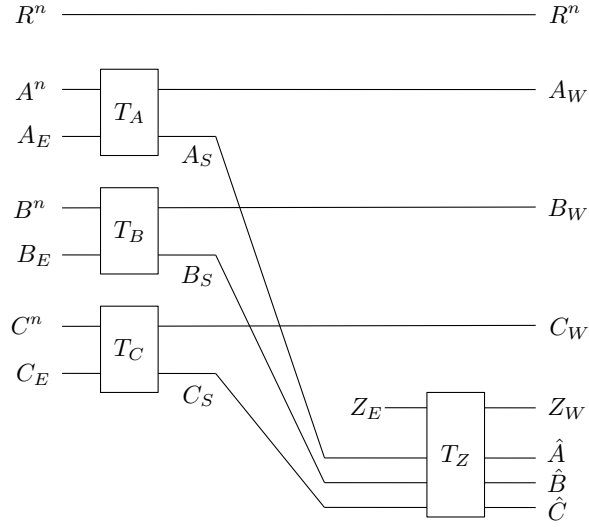

Fig. 8. The diagram describes the purified picture of the whole encoding-decoding procedure.

rates from each senders to the receiver that are achievable under the condition that the transmission error vanishes in the limit of $n \rightarrow \infty$.

A trivial protocol is that each sender individually performs the Schumacher compression [42] on $A_1^{\otimes n}, \dots, A_m^{\otimes n}$, respectively, and send the compressed state to the receiver. This protocol apparently requires quantum communication of the rate $S(A_1) + \dots + S(A_m)$ in total. But there are cases where they can further reduce the total quantum communication rate by exploiting correlations in the state $\psi^{A_1 \dots A_m}$. In such cases, there are trade-off relations among the rates of quantum communication required of the senders in general. However, it is difficult to characterize multipartite correlations that are useful for reducing the communication rates. Consequently, only a few things are known on characterizing the achievable rate region in the distributed compression of multipartite quantum states.

In this section, we consider distributed compression of a class of tripartite quantum states associated with bipartite unitaries. We consider a particular situation in which one of the three senders do nothing, that is, the quantum communication rate of the sender is assumed to be zero. We prove two theorems concerning a lower and an upper bound on the quantum communication rate required in distributed compression. First, we give a lower bound in terms of the minimum entanglement cost or the minimum classical communication cost in EALOCC implementations of the unitary (*Theorem 14*). Second, we derive an upper bound in terms of the partial decoupling cost $D(U)$ (*Theorem 15*).

Let us begin with the precise definition of distributed compression of tripartite states in the form of [31].

Definition 12 Let ψ^{ABC} be a tripartite quantum state and $|\psi\rangle^{ABCR}$ be a purification thereof. Let $\mathcal{E}_n^A : A^n \rightarrow A_S$, $\mathcal{E}_n^B : B^n \rightarrow B_S$ and $\mathcal{E}_n^C : C^n \rightarrow C_S$ be CPTP maps such that the dimension of the output systems A_S, B_S, C_S are $2^{nQ_A}, 2^{nQ_B}$ and 2^{nQ_C} , respectively. Let $\hat{A}, \hat{B}, \hat{C}$ be systems that are isomorphic to A^n, B^n and C^n , respectively, and $\mathcal{D}_n : A_S B_S C_S \rightarrow \hat{A} \hat{B} \hat{C}$ be a CPTP map. A set $(\mathcal{E}_n^A, \mathcal{E}_n^B, \mathcal{E}_n^C, \mathcal{D}_n)$ is called a code for $(\psi^{ABC})^{\otimes n}$ with rate (Q_A, Q_B, Q_C) and error ϵ_n if it satisfies

$$\langle \psi^{\otimes n} | \hat{A} \hat{B} \hat{C} R^n (\mathcal{D}_n \circ (\mathcal{E}_n^A \otimes \mathcal{E}_n^B \otimes \mathcal{E}_n^C)) (|\psi^{\otimes n}\rangle) | \psi^{\otimes n} \rangle^{\hat{A} \hat{B} \hat{C} R^n} \geq 1 - \epsilon_n. \quad (11)$$

Definition 13 A rate triplet (Q_A, Q_B, Q_C) is said to be achievable in the distributed compression of ψ^{ABC} if there exists a sequence of the codes $(\mathcal{E}_n^A, \mathcal{E}_n^B, \mathcal{E}_n^C, \mathcal{D}_n)$ for $(\psi^{ABC})^{\otimes n}$ with the rate (Q_A, Q_B, Q_C) such that $\epsilon_n \rightarrow 0$ in the limit of $n \rightarrow \infty$. The closure of the set of all achievable rate triplets is called the rate region. A rate triplet $(Q_A, +\infty, Q_C)$ is said to be achievable if there exists $q_b \geq 0$ such that (Q_A, q_b, Q_C) is achievable.

As is the case in the fully-quantum Slepian-Wolf protocol, it is important to consider decoupling of senders' system from the reference system [31]. To clarify this point, consider the encoding-decoding procedure described by the encoding maps $\mathcal{E}_n^A, \mathcal{E}_n^B, \mathcal{E}_n^C$, and the decoding map \mathcal{D}_n in the 'purified' picture (Fig. 8). Let $\text{Tr}_{A_W} [T_A (\rho^{A^n} \otimes |0\rangle\langle 0|^{A_E}) T_A^\dagger]$ be the Stinespring dilation of the encoding operations \mathcal{E}_n^A , where T_A is an isometry from $A^n A_E$ to $A_S A_W$. Similarly, let $T_B : B^n B_E \rightarrow B_S B_W$, $T_C : C^n C_E \rightarrow C_S C_W$ and $T_Z : A_S B_S C_S Z_E \rightarrow \hat{A} \hat{B} \hat{C} Z_W$ be isometries associated with the encoding operations $\mathcal{E}_n^B, \mathcal{E}_n^C$ and the decoding operation \mathcal{D}_n , respectively. After the encoding procedure, the whole purified state is given by

$$|\psi'_n\rangle_{A_S B_S C_S R^n A_W B_W C_W} := (T_A \otimes T_B \otimes T_C) |\psi^{\otimes n}\rangle_{A^n B^n C^n R^n} |000\rangle_{A_E B_E C_E}.$$

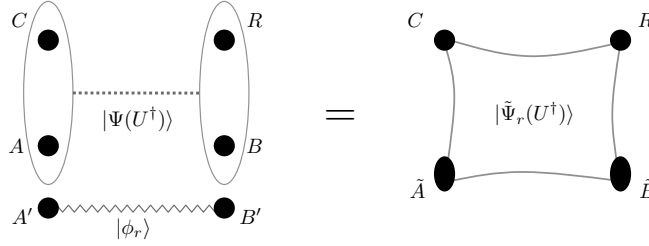

Fig. 9. The distributed compression of a tripartite state $\tilde{\Psi}_r(U^\dagger)^{\tilde{A}\tilde{B}C}$. Its purification $|\tilde{\Psi}_r(U^\dagger)\rangle^{\tilde{A}\tilde{B}CR}$ is composed of $|\Psi(U^\dagger)\rangle^{ABCR}$ and $|\phi_r\rangle^{A'B'}$.

It is proved in [31] that the condition (11) implies

$$\left\| \psi_n'^{R^n A_W B_W C_W} - \psi_n'^{R^n} \otimes \psi_n'^{A_W B_W C_W} \right\|_1 \leq \epsilon'_n, \quad (12)$$

where $\epsilon'_n = 2\sqrt{\epsilon_n}$. Conversely, Uhlmann's theorem guarantees that if the condition (12) is satisfied for some ϵ'_n , there exists a decoding operation \mathcal{D}_n such that the total error is $\epsilon_n \leq 2\sqrt{\epsilon'_n}$. Thus decoupling of senders' system from the reference system is a necessary and sufficient condition for the distributed compression to succeed in high fidelity.

In this section, we consider distributed compression of a tripartite quantum state which is purified into $|\tilde{\Psi}_r(U^\dagger)\rangle^{\tilde{A}\tilde{B}CR} := |\Psi(U^\dagger)\rangle^{ABCR} |\phi_r\rangle^{A'B'}$, where $\tilde{A} = AA'$, $\tilde{B} = BB'$, $|\Psi(U^\dagger)\rangle^{ABCR} := (U^{\dagger AB} \otimes I^{CR}) |\Phi_d\rangle^{AC} |\Phi_d\rangle^{BR}$, and ϕ_r is a pure entangled state with the entanglement entropy r (Fig. 9). We consider a particular situation where $Q_C = 0$ and explore conditions for the rate triplet $(Q_{\tilde{A}}, +\infty, 0)$ to be achievable.

Theorem 14 For any $r \geq 0$, the rate triplet $(Q_{\tilde{A}}, Q_{\tilde{B}}, Q_C) = (\frac{1}{2}R, +\infty, 0)$ is achievable in the distributed compression of $\tilde{\Psi}_r(U^\dagger)^{\tilde{A}\tilde{B}C}$ only if the rate triplet $(R_E, C^{\rightarrow}, C^{\leftarrow}) = (R, R, R)$ is achievable in the EALOCC implementation of U^{AB} .

Proof: Let $(\mathcal{E}_n^A, \mathcal{E}_n^B, \mathcal{E}_n^C, \mathcal{D}_n)$ be a code for $(\tilde{\Psi}_r(U^\dagger)^{\tilde{A}\tilde{B}C})^{\otimes n}$ with the rate $(Q_{\tilde{A}}, Q_{\tilde{B}}, Q_C) = (\frac{1}{2}R, q_b, 0)$ and the error ϵ_n . $Q_C = 0$ implies $\mathcal{E}_n^C = \text{id}^{C^n}$. The state after the encoding procedure, corresponding to (12), is given by

$$|\tilde{\Psi}'_{r,n}(U^\dagger)\rangle^{\tilde{A}_S \tilde{B}_S C^n R^n \tilde{A}_W \tilde{B}_W} := (T_{\tilde{A}} \otimes T_{\tilde{B}}) |\Psi(U^\dagger)^{\otimes n}\rangle^{\tilde{A}^n \tilde{B}^n C^n R^n} |00\rangle^{\tilde{A}_E \tilde{B}_E}.$$

Then the condition (12), by tracing out \tilde{B}_W , implies

$$\left\| \tilde{\Psi}'_{r,n}(U^\dagger)^{R^n \tilde{A}_W C_W} - \frac{1}{d^n} I^{R^n} \otimes \tilde{\Psi}'_{r,n}(U^\dagger)^{\tilde{A}_W C_W} \right\|_1 \leq \epsilon'_n. \quad (13)$$

Construct a protocol for implementing $U^{\otimes n}$ by using the entanglement resource $|\Phi_{2^{n(R+r)}}\rangle^{A_0 B_0}$ as follows. First Alice and Bob apply local operations on A_0 and B_0 , and obtain $|\Phi_{2^{nR}}\rangle^{A'_0 B'_0} |\phi_r^{A'B'}\rangle^{\otimes n}$. Then the whole state is

$$|\Phi_{2^{nR}}\rangle^{A'_0 B'_0} |\phi_r^{A'B'}\rangle^{\otimes n} |\Psi(U^\dagger)^{ABCR}\rangle^{\otimes n} = |\Phi_{2^{nR}}\rangle^{A'_0 B'_0} |\tilde{\Psi}_r(U^\dagger)^{\tilde{A}\tilde{B}CR}\rangle^{\otimes n}.$$

Alice applies the encoding operation T_A on \tilde{A}^n , and thereby split \tilde{A}^n into \tilde{A}_S and \tilde{A}_W . Note that the dimension of \tilde{A}_S is $2^{nR/2}$. Next she applies a controlled-generalized-Pauli gate of the form

$$\tilde{V}^{A'_0 A_S} = \sum_{k'=1}^{2^{nR}} |k'\rangle \langle k'|^{A'_0} \otimes \sigma_{k'}^{A_S}.$$

Alice and Bob then perform step 2~5 in the 'forward process' described in Section VI, which costs nR bits of forward classical communication. After that, the reduced state on Alice's system and $C^n R^n$ is given by

$$\begin{aligned} \tilde{\Psi}_{r,n}^5(U^\dagger)^{\tilde{A}_S \tilde{A}_W C^n R^n} &= 2^{-nR} \sum_{k'=1}^{2^{nR}} \sigma_{k'}^{\tilde{A}_S} \tilde{\Psi}'_{r,n}(U^\dagger)^{\tilde{A}_W C^n R^n \tilde{A}_S} \sigma_{k'}^{\dagger \tilde{A}_S} \\ &= \tilde{\Psi}'_{r,n}(U^\dagger)^{\tilde{A}_W C^n R^n} \otimes \frac{1}{2^{nR/2}} I^{\tilde{A}_S}. \end{aligned}$$

From (13), we obtain

$$\left\| \tilde{\Psi}_{r,n}^5(U^\dagger)^{\tilde{A}_S \tilde{A}_W C^n R^n} - \tilde{\Psi}'_{r,n}(U^\dagger)^{\tilde{A}_S \tilde{A}_W C^n} \otimes \frac{1}{d^n} I^{R^n} \right\| \leq \epsilon_n.$$

Thus Bob can obtain $(\Phi^{BR})^{\otimes n}$ in high fidelity by performing an isometry $W : \tilde{B}B_0 \rightarrow B^n B_1$.

The forward process is followed by the backward process. The entanglement cost and the classical communication cost in the latter are calculated as follows. The state of Alice's remaining systems $A_S A_W$ after the forward process is one obtained by applying an isometry T_A on $\frac{1}{d^n} I^{\tilde{A}^n} \otimes |0\rangle\langle 0|^{A^E}$ and then performing a random generalized Pauli operation on A_S . Thus the entropy is $S(A_S A_W) \geq S(\tilde{A}^n) = n(r + \log d)$. Hence the entanglement cost in the backward step is $S(B_1 | A_S A_W) = S(C^n) - S(A_S A_W) \leq -nr$, which means that nr ebits of entanglement is obtained after the process. On the other hand, since B^n and B_1 are in an almost product state, we have $S(B_1) = S(B^n B_1) - S(B^n) = S(\tilde{B} B_0) - S(B^n) \leq n \log d + n(R+r) - n \log d = n(R+r)$, up to a vanishingly small error. Thus the classical communication cost is $I(C^n : B_1) = S(C^n) + S(B_1) - S(A_S A_W) \leq nR$.

In total, the protocol implements $U^{\otimes n}$ with the cost of nR bits of forward and backward classical communication, by using $n(R+r)$ ebits of initially shared entanglement and obtaining nr ebits afterwards. ■

Theorem 15 The rate triplet $(Q_{\tilde{A}}, Q_{\tilde{B}}, Q_C) = (\frac{1}{2}R, \log d + \frac{3}{2}R, 0)$ is achievable in distributed compression of $|\tilde{\Psi}_r(U^\dagger)\rangle$ for any $r \geq \frac{3}{2}R$ if $R \geq D(U)$.

Proof: Suppose $R \geq D(U)$ and consider the 'forward process' to implement $U^{\otimes n}$ by using an entanglement resource $|\Phi_{2^{nR}}\rangle^{A_0 B_0}$. The process requires nR bits of classical communication from Alice to Bob. Since the classical message is uniformly distributed and is decoupled from the state obtained after the forward process, we can apply the *coherent communication identity* [43]. That is, we can replace nR bits of classical communication by $\frac{1}{2}nR$ bits of quantum communication and an additional entanglement resource $|\Phi_{2^{nR/2}}\rangle^{A'_0 B'_0}$ shared in advance. The 'coherent version' of the forward process obtained in this way is composed of three steps: Alice performs a unitary on $A^n A_0 A'_0$, sends A'_0 to Bob, and Bob performs a unitary on $B^n B_0 B'_0 A_0$. $A^n A_0 C^n$ and R^n are decoupled after this process up to a vanishingly small error.

Assume $r = \frac{3}{2}R$. In distributed compression, the senders initially share $(|\tilde{\Psi}_r(U^\dagger)\rangle^{\tilde{A}\tilde{B}CR})^{\otimes n} = (|\Psi(U^\dagger)\rangle^{ABCR})^{\otimes n} (|\Psi_{3R/2}\rangle^{A'B'})^{\otimes n}$. Divide $|\Psi_{3R/2}\rangle^{\otimes n}$ into $|\Phi_{2^{nR}}\rangle^{A_0 B_0}$ and $|\Phi_{2^{nR/2}}\rangle^{A'_0 B'_0}$. First, Bob sends all his system $B B_0 B_1$ to the receiver, which requires $n(\log d + \frac{3}{2}R)$ qubits of quantum communication. Next, the receiver takes over Bob's role, and Alice and the receiver performs the coherent forward process, which requires $\frac{1}{2}nR$ qubits of quantum communication. The receiver then has all the purification of the reference system, since $A^n A_0 C^n$ and R^n are almost decoupled. Thereby distributed compression is accomplished. Generalization to an arbitrary $r \geq \frac{3}{2}R$ is straightforward. ■

Corollary 16 The rate triplet $(Q_{\tilde{A}}, Q_{\tilde{B}}, Q_C) = (\frac{1}{2}K(U_{Cl}), \frac{3}{2}K(U_{Cl}) + \log d, 0)$ is achievable in distributed compression of $|\tilde{\Psi}_{3R/2}(U_{Cl}^\dagger)\rangle$ for any generalized Clifford operator U_{Cl} .

Proof: Follows from Theorem 10 and Theorem 15. ■

Example. Consider the two-qubit controlled- Z gate U_{CZ} , which is a Clifford gate. We have $K(U_{CZ}) = 1$ and thus the rate triplet $(Q_{\tilde{A}}, Q_{\tilde{B}}, Q_C) = (\frac{1}{2}, \frac{5}{2}, 0)$ is achievable in distributed compression of $|\tilde{\Psi}_{3/2}(U_{CZ}^\dagger)\rangle$. Contrary to an argument in [31], it is possible to reduce $Q_{\tilde{A}} + Q_C$ by exploiting correlation between \tilde{A} and C despite the fact that there is no entanglement in $|\tilde{\Psi}_{3/2}(U_{CZ}^\dagger)\rangle^{AC}$.

IX. CONCLUSION AND DISCUSSION

In this paper, we formulate and investigate compressibility of the entanglement cost and the classical communication cost in an entanglement-assisted LOCC implementation of bipartite unitaries. We reveal that distributed quantum computation can be analyzed within the framework of quantum Shannon theory. In particular, we show that the decoupling approach, which is known to be a powerful tool in quantum Shannon theory, is also useful in the analysis of distributed quantum computation.

The power of bipartite unitaries as a resource for classical communication and entanglement generation is well investigated in [24], [44]–[50]. Our approach is complementary to their approaches in that we address asymptotic costs for implementing unitaries rather than their power as a resource.

The task formulated in this paper is different from either source coding, channel coding, entanglement distillation or dilution. Bipartite unitary operations can be regarded as bidirectional quantum channels. In this sense, the task is to simulate a *pure quantum bidirectional channel* by using pure entanglement and classical communication. It is similar yet different from quantum reverse Shannon theorem [51], [52], in which the task is to simulate a *noisy unidirectional quantum channel* by using pure entanglement and classical (or quantum) communication. We propose that we add *operations* to the framework of quantum Shannon theory, besides channels and correlations.

APPENDIX A

In this Appendix, we prove that the condition (1) implies (2). For $n = 1$, consider a quantum operation \mathcal{E} on $\mathcal{S}(\mathcal{H}^A \otimes \mathcal{H}^B)$ defined as $\mathcal{E}(\rho) = U^\dagger \hat{M}_1(\rho) U$. Suppose that the input to this operation is a pure state that is randomly chosen according to the Haar measure on $\mathcal{H}^A \otimes \mathcal{H}^B$. The average fidelity is defined as

$$\bar{F}(\mathcal{E}) := \int p(d\phi) F(\mathcal{E}(|\phi\rangle), |\phi\rangle).$$

The corresponding entanglement fidelity is defined as

$$F_e(\mathcal{E}) := F(\rho(\mathcal{E}), |\Phi_d\rangle^{AR_A} |\Phi_d\rangle^{BR_B}),$$

where $\rho(\mathcal{E}) = \mathcal{E}(|\Phi_d^{AR_A}\rangle |\Phi_d^{BR_B}\rangle)$. It is proved in [32] that $\bar{F}(\mathcal{E}) \geq F_e(\mathcal{E})$. On the other hand, we have

$$\bar{F}(\mathcal{E}) = \int p(d\phi) F(\hat{\mathcal{M}}_1(\phi), U|\phi\rangle)$$

and

$$\begin{aligned} F_e(\mathcal{E}) &= F(\rho(\hat{\mathcal{M}}_1), |\Psi(U)\rangle) \\ &\geq F(\rho(\mathcal{M}_1), |\Psi(U)\rangle |\Phi_{L_1}\rangle^{A_1 B_1}). \end{aligned}$$

Thus we obtain (2) from (1). Generalizing to an arbitrary n is straightforward.

ACKNOWLEDGMENT

The authors thank Akihito Soeda, Fabian Furrer, Masaki Owari, Go Kato and Tomohiro Ogawa for useful discussions.

REFERENCES

- [1] I. Devetak, A. W. Harrow, and A. Winter, "A family of quantum protocols," *Phys. Rev. Lett.*, vol. 93, p. 230504, 2004.
- [2] I. Devetak, A. W. Harrow, and A. J. Winter, "A resource framework for quantum Shannon theory," *IEEE Trans. Inf. Theory*, vol. 54, p. 4587, 2008.
- [3] M.-H. Hsieh and M. M. Wilde, "Trading classical communication, quantum communication, and entanglement in quantum Shannon theory," *IEEE Trans. Inf. Theory*, vol. 56, p. 4705, 2010.
- [4] M. Horodecki, J. Oppenheim, and A. Winter, "Partial quantum information," *Nature*, vol. 436, p. 673, 2005.
- [5] —, "Quantum state merging and negative information," *Comm. Math. Phys.*, vol. 269, p. 107, 2007.
- [6] A. Abeyesinghe, I. Devetak, P. Hayden, and A. Winter, "The mother of all protocols: Reconstructing quantum information's family tree," *Proc. R. Soc. A*, vol. 465, p. 2537, 2009.
- [7] I. Devetak and J. Yard, "Exact cost of redistributing multipartite quantum states," *Phys. Rev. Lett.*, vol. 100, p. 230501, 2008.
- [8] J. T. Yard and I. Devetak, "Optimal quantum source coding with quantum side information at the encoder and decoder," *IEEE Trans. Inf. Theory*, vol. 55, p. 5339, 2009.
- [9] M.-Y. Ye, Y.-K. Bai, and Z. D. Wang, "Quantum state redistribution based on a generalized decoupling," *Phys. Rev. A*, vol. 78, p. 030302, 2008.
- [10] J. Oppenheim, "State redistribution as merging: Introducing the coherent relay," e-print arXiv:0805.1065, 2008.
- [11] P. Hayden, M. Horodecki, A. Winter, and J. Yard, "A decoupling approach to the quantum capacity," *Open Sys. Inf. Dyn.*, vol. 15, p. 7, 2008.
- [12] F. Dupuis, M. Berta, J. Wullschleger, and R. Renner, "One-shot decoupling," *Comm. in Math. Phys.*, vol. 328, p. 251, 2014.
- [13] F. Dupuis, "The decoupling approach to quantum information theory," e-print arXiv:1004.1641, 2010.
- [14] N. Ma and P. Ishwar, "Some results on distributed source coding for interactive function computation," *IEEE Trans. Inf. Theory*, vol. 57, p. 6180, 2011, also see references therein.
- [15] A. E. Gamal and Y.-H. Kim, *Network Information Theory*. Cambridge University Press, 2011.
- [16] J. Cirac, A. Ekert, S. Huelga, and C. Machiavello, "Distributed quantum computation over noisy channels," *Phys. Rev. A*, vol. 59, p. 4249, 1999.
- [17] A. Yimsiriwattana and S. J. L. Jr., "Distributed quantum computing: A distributed Shor algorithm," *Proc. SPIE*, vol. 5436, p. 360, 2004.
- [18] C. H. Bennett, G. Brassard, C. Crépeau, R. Jozsa, A. Peres, and W. K. Wootters, "Teleporting an unknown quantum state via dual classical and Einstein-Podolsky-Rosen channels," *Phys. Rev. Lett.*, vol. 70, p. 1895, 1993.
- [19] J. Eisert, K. Jacobs, P. Papadopoulos, and M. Plenio, "Optimal local implementation of nonlocal quantum gates," *Phys. Rev. A*, vol. 62, p. 052317, 2000.
- [20] J. I. Cirac, W. Dur, B. Kraus, and M. Lewenstein, "Entangling operations and their implementation using a small amount of entanglement," *Phys. Rev. Lett.*, vol. 86, p. 544, 2001.
- [21] B. Groisman and B. Reznik, "Implementing nonlocal gates with nonmaximally entangled states," *Phys. Rev. A*, vol. 71, p. 032322, 2005.
- [22] L. Chen and Y.-X. Chen, "Probabilistic implementation of a nonlocal operation using a nonmaximally entangled state," *Phys. Rev. A*, vol. 71, p. 054302, 2005.
- [23] M.-Y. Ye, Y.-S. Zhang, and G.-C. Guo, "Efficient implementation of controlled rotations by using entanglement," *Phys. Rev. A*, vol. 73, p. 032337, 2006.
- [24] D. W. Berry, "Implementation of multipartite unitary operations with limited resources," *Phys. Rev. A*, vol. 75, p. 032349, 2007.
- [25] N. B. Zhao and A. M. Wang, "Local implementation of nonlocal operations with block forms," *Phys. Rev. A*, vol. 78, p. 014305, 2008.
- [26] L. Yu, R. B. Griffiths, and S. M. Cohen, "Efficient implementation of bipartite nonlocal unitary gates using prior entanglement and classical communication," *Phys. Rev. A*, vol. 81, p. 062315, 2010.
- [27] S. M. Cohen, "Optimizing local protocols for implementing bipartite nonlocal unitary gates using prior entanglement and classical communication," *Phys. Rev. A*, vol. 81, p. 062316, 2010.
- [28] A. Soeda, P. Turner, and M. Murao, "Entanglement cost of implementing controlled-unitary operations," *Phys. Rev. Lett.*, vol. 107, p. 180501, 2011.
- [29] D. Stahlke and R. Griffiths, "Entanglement requirements for implementing bipartite unitary operations," *Phys. Rev. A*, vol. 84, p. 032316, 2011.
- [30] C. Ahn, A. C. Doherty, P. Hayden, and A. J. Winter, "On the distributed compression of quantum information," *IEEE Trans. Inf. Theory*, vol. 52, p. 4349, 2006.
- [31] D. Avis, P. Hayden, and I. Savov, "Distributed compression and multipartite squashed entanglement," *J. Phys. A: Math Theor.*, vol. 41, p. 115301, 2008.
- [32] B. Schumacher, "Sending entanglement through noisy quantum channels," *Phys. Rev. A*, vol. 54, p. 2614, 1996.
- [33] I. Devetak, "Triangle of dualities between quantum communication protocols," *Phys. Rev. Lett.*, vol. 97, p. 140503, 2006.
- [34] M. Nielsen, C. Dawson, J. Dodd, A. Gilchrist, D. Mortimer, T. Osborne, M. B. A. Harrow, and A. Hines, "Quantum dynamics as a physical resource," *Phys. Rev. A*, vol. 67, p. 052301, 2003.
- [35] J. Oppenheim and B. Reznik, "Probabilistic and information-theoretic interpretation of quantum evolutions," *Phys. Rev. A*, vol. 70, p. 022312, 2004.
- [36] D. W. Berry, "Lower bounds for communication capacities of two-qudit unitary operations," *Phys. Rev. A*, vol. 76, p. 062302, 2007.
- [37] B. Schumacher and M. D. Westmoreland, "Sending classical information via noisy quantum channel," *Phys. Rev. A*, vol. 56, p. 131, 1997.
- [38] A. S. Holevo, "The capacity of the quantum channel with general signal states," *IEEE Trans. Inf. Theory*, vol. 44, p. 269, 1998.
- [39] A. Uhlmann, "The 'transition probability' in the state space of a *-algebra," *Pep. Math. Phys.*, vol. 9, p. 273, 1976.
- [40] R. Jozsa, "Fidelity for mixed quantum states," *J. Mod. Optics*, vol. 41, p. 2315, 1994.
- [41] B. Groisman, S. Popescu, and A. Winter, "Quantum, classical, and total amount of correlations in a quantum state," *Phys. Rev. A*, vol. 72, p. 032317, 2005.

- [42] B. Schumacher, "Quantum coding," *Phys. Rev. A*, vol. 51, p. 2738, 1995.
- [43] A. Harrow, "Coherent communication of classical messages," *Phys. Rev. Lett.*, vol. 92, p. 097902, 2004.
- [44] B. Kraus and J. I. Cirac, "Optimal creation of entanglement using a two-qubit gate," *Phys. Rev. A*, vol. 63, p. 062309, 2001.
- [45] M. S. Leifer, L. Henderson, and N. Linden, "Optimal entanglement generation from quantum operations," *Phys. Rev. A*, vol. 67, p. 012306, 2003.
- [46] C. H. Bennett, A. Harrow, D. W. Leung, and J. A. Smolin, "On the capacities of bipartite hamiltonians and unitary gates," *IEEE Trans. Inf. Theory*, vol. 49, p. 1895, 2003.
- [47] D. W. Berry and B. C. Sanders, "Relation between classical communication capacity and entanglement capability for two-qubit unitary operations," *Phys. Rev. A*, vol. 68, p. 032312, 2003.
- [48] N. Linden, J. A. Smolin, and A. Winter, "Entangling and disentangling power of unitary transformations are not equal," *Phys. Rev. Lett.*, vol. 103, p. 030501, 2009.
- [49] A. W. Harrow and P. W. Shor, "Time reversal and exchange symmetries of unitary gate capacities," *IEEE Trans. Inf. Theory*, vol. 56, p. 462, 2010.
- [50] S. M. Cohen, "All maximally entangling unitary operators," *Phys. Rev. A*, vol. 84, p. 052308, 2011.
- [51] M. Berta, M. Christandl, and R. Renner, "The quantum reverse shannon theorem based on one-shot decoupling theorem," *Comm. Math. Phys.*, vol. 306, p. 579, 2011.
- [52] C. H. Bennett, I. Devetak, A. W. Harrow, P. W. Shor, and A. Winter, "The quantum reverse shannon theorem and resource tradeoffs for simulating quantum channels," *IEEE Trans. Inf. Theory*, vol. 60, p. 2926, 2014.