

## WEAKLY SUPERVISED CLUSTERING: LEARNING FINE-GRAINED SIGNALS FROM COARSE LABELS

BY STEFAN WAGER<sup>\*,1</sup>, ALEXANDER BLOCKER<sup>†</sup> AND NIALL CARDIN<sup>†</sup>

*Stanford University\* and Google, Inc.†*

Consider a classification problem where we do not have access to labels for individual training examples, but only have average labels over subpopulations. We give practical examples of this setup and show how such a classification task can usefully be analyzed as a *weakly supervised clustering problem*. We propose three approaches to solving the weakly supervised clustering problem, including a latent variables model that performs well in our experiments. We illustrate our methods on an analysis of aggregated elections data and an industry data set that was the original motivation for this research.

**1. Introduction.** A search provider wants to know whether people who clicked on a given search result found it useful.<sup>2</sup> A searcher’s behavior can provide valuable clues as to whether she liked the result: if she immediately hit the back button upon seeing the landing page, she probably had a bad experience. Conversely, a searcher interacting with the result may be seen as a positive signal.

Many online providers seek to directly estimate user happiness with click-level proxies. For example, in the context of web search, one well-known signal of user dissatisfaction is a “bounce,” where people go to a search result but then immediately return to the search page [Levy (2011), page 47, Sculley et al. (2009)]. Bucklin and Sismeiro (2009) give an overview of how data about site usage patterns is used in online marketing. However, using hand-crafted proxies to understand user experience has its limits. It requires analysts to map these proxies to user satisfaction in a usually unprincipled way, and different proxies may lead to contradicting conclusions.

This paper addresses the question: how can we combine multiple click-level features into a single principled measure of user satisfaction? The main

---

Received June 2014; revised February 2015.

<sup>1</sup>Supported by a B. C. and E. J. Eaves Stanford Graduate Fellowship.

*Key words and phrases.* Latent variables model, uncertain class label.

This is an electronic reprint of the original article published by the Institute of Mathematical Statistics in *The Annals of Applied Statistics*, 2015, Vol. 9, No. 2, 801–820. This reprint differs from the original in pagination and typographic detail.

<sup>2</sup>This example is hypothetical, but conveys the key difficulties from a real problem faced by a large internet company.

difficulty is that we have no explicit response to train on, as searchers do not tell us whether or not they were satisfied with any given click. What we do have is side information about whether some subpopulation of clicks was mostly satisfied or not: in the context of our example, we might know from outside sources (e.g., human raters) that some search results are good ones and that most users who click to them should be satisfied, whereas other results are of lesser quality and may leave some searchers disappointed.

Formally, we are faced with a binary classification task where we do not have labels for individual clicks, but only have a rough idea of the average fraction of satisfied clicks over large subpopulations. In other words, we have a classification task where the available training labels are much coarser-grained than the signal we want to fit.

We adopt a weakly supervised approach, where we use the coarse training labels to guide a clustering algorithm. At a fundamental level, we expect satisfied versus unsatisfied behaviors to look different from each other in a way that does not depend on group (here, the search result); thus, we should be able to construct a global clustering of clicks that respects this distinction. But there are presumably many natural ways to divide clicks into two groups other than the satisfied/unsatisfied distinction: we might expect energetic/tired or hurried/leisurely clicks to also split into distinct clusters. Our goal is to use side information to avoid this issue and pick out the “right” way of clustering the data. We do this by forcing the clustering algorithm to respect marginal class memberships for different subpopulations: concretely, we want most clicks on good search results to be in the good cluster, whereas clicks on the mediocre results should be more evenly split.

We call this task of finding a clustering of the data that respects side information about marginal cluster membership for multiple subpopulations a *weakly supervised clustering problem*. This problem surfaces when we want to understand click or behavior level data, but only have access to coarse-grained side information for training. Other examples that can be cast as weakly supervised clustering problems include the following.

EXAMPLE 1. An online advertiser wants to understand what kind of click-level interaction with an ad suggests that a customer will later visit a physical store. It is not always practical to ask users directly whether or not they visited a store after seeing an ad, and so this is not a standard supervised problem. However, the advertiser may have some idea about how successful the ads were at a campaign level. With a weakly supervised clustering approach, it can use this highly aggregated campaign-level signal to learn how to interpret click-level behaviors.

EXAMPLE 2. A political scientist wants to study how different demographic groups voted in an election. However, instead of having access to

voter-level data, she only gets to see aggregated state-level election data. In Section 6.1, we cast this example as a weakly supervised clustering problem and use our method to analyze aggregated data from a US presidential election.

In this paper, we compare three possible approaches to the weakly supervised clustering problem: a latent variables model, a method of moments estimate, and a naive approach that turns the problem into a supervised problem using a hard assignment. We find the method of moments approach to be prohibitively unstable even with large data sets, whereas the naive approach has almost no power in all but the simplest situations. Meanwhile, the latent variables approach worked well in many examples, including an industry example presented in Section 6.2 that motivated this work.

1.1. *Related work.* Latent variables models have often been found to be powerful solutions to weak supervision problems (also called distant supervision problems). For example, Surdeanu et al. (2012) use a latent variables model to fit distantly supervised relation extraction, and Täckström and McDonald (2011a) use a similar approach for sentence-level sentiment analysis.

Generative structures similar to that underlying our latent variables model have successfully been used in unsupervised topic modeling. Prominent examples include probabilistic latent semantic analysis [Hofmann (2001)] and latent Dirichlet allocation [Blei, Ng and Jordan (2003)]. The idea of using weak or ambiguous topic membership information to guide latent Dirichlet allocation has been explored, among others, by Toutanova and Johnson (2007) and Xu, Yang and Li (2009).

Other approaches to using side information in clustering include the work of Xing et al. (2002), who showed how to enable clustering algorithms to take into account user-provided examples of similar and dissimilar pairs of points, and a group-wise support-vector machine proposed by Rueping (2010). Gordon (1999) reviews methods for incorporating side information into clustering algorithms using constraints.

**2. Weakly supervised clustering.** Our goal is to cluster elements  $i$  based on fine-grained features  $X_i$  in a way that aligns with side information on the average cluster membership across various groups. Concretely, in the context of the voting example,  $X$  could encode voter demographic information  $X = \{\text{Income bracket, Union membership, } \dots\}$ , whereas in the web search example,  $X$  could be a click-level behavior  $X = \{\text{Did the click bounce, } \dots\}$ .

To see the role of side information in weakly supervised clustering, consider the following example. Suppose that, in the context of our web search

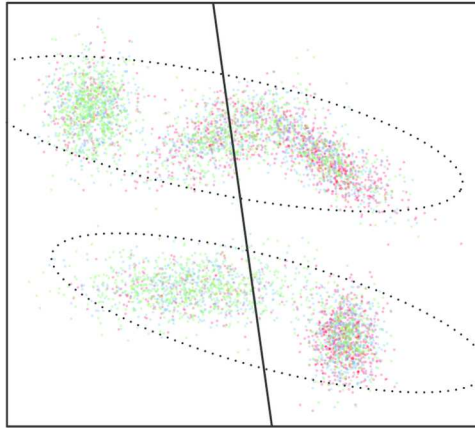

FIG. 1. *A motivating example. Each dot corresponds to a single click-level behavior. We know that dots corresponding to green, blue and red dots are happy with probabilities of 80%, 60% and 10%, respectively. The data are drawn from a generative model for which the solid line is the happy/sad decision boundary that minimizes logistic loss. However, unsupervised Gaussian clustering divides the data into two ellipses that are roughly orthogonal to the optimal decision boundary. This paper develops methods that use side information about the marginal happiness levels of green, blue and red clicks to help us to recover the correct decision boundary.*

example, we have click-level data for 3 search results and that, for visualization purposes, the click-level data  $X$  can be represented in 2 dimensions as in Figure 1. Suppose, moreover, that green and blue clicks are happy with probabilities of 80% and 60%, respectively, but that red clicks are unhappy 90% of the time; our goal is to cluster these clicks into happy and sad clicks using this side information.

If we did not have any side information, the best we could do is attempt an unsupervised clustering of the data. Standard Gaussian clustering as implemented in the R-library `mclust` [Fraley et al. (2012)] divides the data into ellipsoids as depicted in Figure 1. It is quite clear that these ellipsoids do not concur with our side information. In fact, given the generative model used to produce the data, the best linear division of our data into happy and sad clicks is given by the solid nearly vertical line. Thus, the clustering obtained with unsupervised Gaussian mixtures is roughly orthogonal to the division we would want.

An alternative baseline would be to ignore the latent structure of the problem completely and simply set up a regression problem where we use the coarse averaged labels as responses. Concretely, if we know that 80% of green observations are happy, we could try to replace each one of them with a positive example with weight 0.8 and a negative example with weight 0.2. We discuss this approach further in Section 3.1. In our experiments, this naive approach was unable to capture most of the signal.

The goal of this paper is to develop techniques allowing us to use the side information about the green, blue and red dots to recover the decision boundary we want. Below we propose a generative model that makes explicit the assumptions we need for weakly supervised clustering to be possible. The subsequent section then proposes different ways of fitting this generative model.

*2.1. The key assumption.* The key assumption we need to make is that click-level behavior is conditionally independent of the side information given cluster membership. For example, in the context of our search provider example, we assume that user behavior depends on satisfaction alone; the search result quality only enters into the model through its influence on user satisfaction.

This assumption can be represented using the graphical model in Figure 2. Let search results be indexed by  $i \in \{1, \dots, I\}$  and clicks on the  $i$ th result be indexed by  $j \in \{1, \dots, J_i\}$ . Each result is associated with a quality  $\mu_i$ , which affects whether individual clicks  $j \in \{1, \dots, J_i\}$  on the result will be satisfied ( $Z_{ij} = 1$ ) or not ( $Z_{ij} = 0$ ). The searcher then exhibits a click-level behavior  $X_{ij}$  that only depends on the satisfaction level  $Z_{ij}$ .

Our main assumption is that there is no edge going directly from  $\mu$  to  $X$ . Thus, we force information to flow through the latent node  $Z$  and thereby induce a clustering. A similar point is emphasized by Täckström and McDonald (2011b).

*2.2. A generative model.* To build a practical weakly supervised clustering algorithm on top of the conditional independence structure specified in Figure 2, we propose a simple generative model:

- Each search result  $i \in \{1, \dots, I\}$  has an underlying quality  $\mu_i \in \mathbb{R}$ .

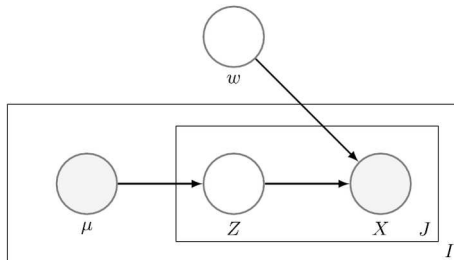

FIG. 2. Graphical model depicting the key assumption that  $\mu_i$  and  $X_{ij}$  are conditionally independent given  $Z_{ij}$ . Here, each search result is associated with an underlying quality score  $\mu_i$  which affects click-level user satisfaction  $Z_{ij}$ , which in turn influences behavior  $X_{ij}$ . The grayed-out nodes are observed, and the boxes indicate repeated observations.

- The satisfaction of each click  $j \in \{1, \dots, J_i\}$  on the  $i$ th search result is then independently drawn from the Bernoulli distribution

$$Z_{ij} \sim \text{Bern}(\sigma(\mu_i)),$$

where  $\sigma(x) = 1/(1 + e^{-x})$  is the sigmoid function.

- The searcher then exhibits a behavior  $X_{ij} \in \{1, \dots, K\}$  according to the multinomial distribution

$$X_{ij} \sim \text{Multinom}(w_{Z_{ij}}),$$

where  $w_0$  and  $w_1$  represent probability distributions on  $\{1, \dots, K\}$  (formally, they are vectors in  $\mathbb{R}_+^K$  whose entries sum to 1).

It is also possible to allow for more complicated distributional assumptions for  $X$ : for example,  $X_{ij}$  could be modeled as drawn from a Gaussian mixture or from a cross-product of independent multinomials. For our purposes, however, we found it simplest to describe click-level behavior with a single binning obtained by crossing multiple factors.

In practice, we do not know the underlying quality  $\mu_i$  and only have noisy estimates of them. This is formalized in the graphical model depicted in Figure 3. The true  $\mu_i$  is drawn from some prior  $F_0$ ; we then get to observe a noisy estimate of  $\mu_i$  provided by outside human evaluation (HE). For example, the quantity HE could be obtained by asking workers on Amazon Mechanical Turk to rate the likelihood that someone clicking on a search result would be satisfied by it. We model the rater noise as  $\text{HE}_i \sim \mathcal{N}(\mu_i, \sigma_H^2)$ . The case with  $\sigma_H^2 = 0$  reduces to the simpler model from Figure 2, while in the limit where  $\sigma_h^2 \rightarrow \infty$  the outside information HE is only used for initialization.

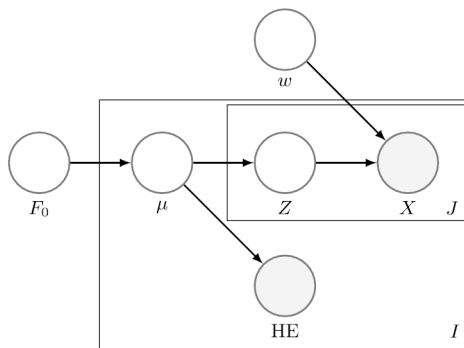

FIG. 3. Extension of the graphical model presented in Figure 2 that allows for the contingency that the  $\mu_i$  are not observed directly, but that we instead have noisy human evaluation (HE) estimates of the  $\mu_i$ . The grayed-out nodes are observed, and the boxes indicate repeated observations.

2.3. *The estimand.* The key unknown parameters in our generative model are the multinomial probabilities  $w_0$  and  $w_1$ . From an interpretative point of view, however, what we really want to know is the posterior probability that a click was satisfied given a behavior. These can be obtained by Bayes' rule:

$$\rho(k) := \mathbb{P}[Z = 1 | X = k] = \frac{\pi w_1^{(k)}}{(1 - \pi)w_0^{(k)} + \pi w_1^{(k)}},$$

where the prior probability  $\pi := \mathbb{P}[Z = 1]$  is taken with respect to the process that generated the  $\mu_i$ . We will frame all our fitting procedures with the aim of estimating the posterior probability vector  $\rho$  instead of  $w_0$  and  $w_1$  themselves.

**3. Simple baselines.** The hierarchical model defined in the previous section naturally lends itself to being solved by maximum likelihood using an EM algorithm, described in Section 4. That being said, the likelihood function of the whole latent variables model is somewhat complicated and, in particular, is not convex. Before going for a complex solution, we may want to check that simpler ones do not work. In this section, we discuss some convex baselines. In the experiments presented in Section 6, we will find the full maximum likelihood solution to vastly outperform its competitors, suggesting that its complexity is not in vain.

3.1. *A direct approach.* A first idea for dealing with the model in Figure 2 is just to ignore the latent structure. Instead of letting  $Z_{ij}$  be a random Bernoulli variable with probability parameter  $\sigma(\mu_i)$ , we could just create two artificial observations: one with  $Z_{ij} = 1$  and weight  $\sigma(\mu_i)$ , and one with  $Z_{ij} = 0$  and weight  $1 - \sigma(\mu_i)$ . In other words, we swap out a single observation with an unknown latent label and replace it with multiple observations with hard-assigned satisfaction levels; the original probability parameter of the Bernoulli distribution is used to set the weights of each artificial data point. This transformation leads to simple estimates for the posterior probabilities  $\rho(k)$ :

$$(3.1) \quad \hat{\rho}(k) = \frac{1 + \sum_{i,j} \sigma(\mu_i) 1(\{X_{ij} = k\})}{2 + \sum_{i,j} 1(\{X_{ij} = k\})},$$

where as usual we added one pseudo-observation in each behavioral bin for numerical stability [e.g., Agresti (2002)].

The main downside with this naive approach is that it cannot fit variations in click-level behavior within groups and cannot account for the fact that some clicks on bad search results may be happy and vice-versa. As we will see in our examples, this will cost the method a lot of power. Ignoring

the pseudo-observations, this naive approach is equivalent to just training a linear regression with features  $X_{ij}$  and response  $\sigma(\mu_i)$  (i.e., we regress the coarse responses on the fine predictors directly). Thus, we can take the approach as a baseline for what happens when we do not model latent click-level happiness.

*3.2. Method of moments.* We can also try to estimate the  $w_i$  by moment matching. If we set a flat prior on the  $\mu_i$  [or, equivalently a Haldane prior on  $\sigma(\mu_i)$ ] and provided that the number of replicates  $J_i$  is independent of  $\mu_i$ , then

$$\begin{aligned}\mathbb{E}[\sigma(\mu_i)|X_{i1}, \dots, X_{iJ_i}] &= \frac{1}{J_i} \sum_{j=1}^{J_i} \rho(X_{ij}) \\ &= \omega_i \cdot \rho,\end{aligned}$$

where  $\omega_i$  is the empirical behavior distribution for the  $i$ th search result:  $\omega_i^{(k)} = |\{X_{ij} = k\}|/J_i$ . Writing  $\sigma(\mu) \in [0, 1]^I$  for the vector containing the  $\sigma(\mu_i)$  and  $\Omega$  for the matrix with rows  $\omega_i$ , we see that

$$(3.2) \quad \mathbb{E}[\sigma(\mu)|\{X_{ij}\}] = \Omega\rho.$$

In practice, however, we know  $\Omega$  and  $\sigma(\mu)$ , and want to fit  $\rho$  [with the model from Figure 3, we can use  $\sigma(\text{HE}_i)$  as a surrogate for  $\sigma(\mu_i)$ ]. We could nevertheless try to use this moments equation as guidance and fit  $\rho$  by minimizing squared deviation from the moments equation (3.2). This leads to an estimate

$$(3.3) \quad \hat{\rho} = (\Omega^\top \Omega)^{-1} \Omega^\top \sigma(\mu).$$

This estimator can perform well on very large data sets; moreover, Quadrianto et al. (2009) establish theoretical regimes where this method is guaranteed to perform well. However, we found it to be prohibitively noisy on most of our problems of interest: the estimates for  $\hat{\rho}(k)$  are often not even contained in the  $[0, 1]$  interval. The estimator also has some fairly surprising failure modes, as discussed in Section 7.2.

**4. An EM algorithm for the latent variables model.** In the previous section, we discussed some simple heuristic approaches to weakly supervised clustering. Here, we show how to do maximum likelihood estimation for the full latent variables model using an EM algorithm [Dempster, Laird and Rubin (1977)]. The heuristic approaches from before focused on the simpler model from Figure 2; EM, however, allows us the flexibility to work with the full graphical structure from Figure 3. Our likelihood function is not unimodal and so the proposed algorithm is only guaranteed to converge to



a local optimum rather than a global one, but in practice our initialization scheme appears to have consistently brought us near a good optimum. For a review of how the EM-algorithm can be used to solve latent variables models see, for example, Bishop and Nasrabadi (2006). Another algorithm that may be worth considering for this problem is the MM-algorithm [e.g., Lange, Hunter and Yang (2000), Hunter and Lange (2004)].

All the individual steps taken by our EM-algorithm are simple and our algorithm scales linearly in the size of the training data. Our implementation in native R can handle around one million clicks spread over ten thousand groups in just over 5 seconds.

*Initialization.* We initialize our model by forward-propagating the information obtained from human evaluation (HE):

$$(4.1) \quad \hat{\mu}_i \leftarrow \text{HE}_i,$$

$$(4.2) \quad \hat{z}_{ij} := \mathbb{P}[\widehat{Z}_{ij} = 1] \leftarrow \sigma(\hat{\mu}_i),$$

$$(4.3) \quad \hat{w}_0^{(k)} \leftarrow \frac{1 + \sum_{ij} (1 - \hat{z}_{ij}) 1(\{X_{ij} = k\})}{K + \sum_{ij} (1 - \hat{z}_{ij})},$$

$$(4.4) \quad \hat{w}_1^{(k)} \leftarrow \frac{1 + \sum_{ij} \hat{z}_{ij} 1(\{X_{ij} = k\})}{K + \sum_{ij} \hat{z}_{ij}}.$$

We again added pseudo-observations for stability. This solution effectively amounts to initializing our latent structure using the naive model from Section 3.1.

*E-step.* Given estimates for  $\hat{\mu}_i$ ,  $\hat{w}_0$  and  $\hat{w}_1$ , the E-step for inferring latent variable probabilities  $\hat{z}_{ij}$  is

$$(4.5) \quad \hat{z}_{ij} \leftarrow \frac{\sigma(\hat{\mu}_i) \cdot \hat{w}_1^{(X_{ij})}}{(1 - \sigma(\hat{\mu}_i)) \cdot \hat{w}_0^{(X_{ij})} + \sigma(\hat{\mu}_i) \cdot \hat{w}_1^{(X_{ij})}}.$$

*M-step.* In the M-step, we need to update both the  $\hat{\mu}$  and the  $\hat{w}$  given fixed estimates of  $\hat{z}$ . The M-step for  $\hat{w}$  is the same update rule we used in our initialization, namely, (4.3), (4.4). Meanwhile, our updated estimate for  $\hat{\mu}_i$  must maximize the marginal log-likelihood, that is,

$$(4.6) \quad \hat{\mu}_i = \operatorname{argmin}_{\mu_i} \left\{ \frac{(\mu_i - \text{HE}_i)^2}{2\sigma_H^2} - \sum_{j=1}^{J_i} (\mu_i \hat{z}_{ij} - \log(1 + e^{\mu_i})) + \log(f_0(\mu_i)) \right\}.$$

For appropriate choices of prior density  $f_0$ , the minimization objective is convex and the solution  $\hat{\mu}_i$  is uniquely defined by a first-order condition on the gradient. Putting an improper flat prior on  $\mu_i$ , we get

$$(4.7) \quad \frac{\hat{\mu}_i - \text{HE}_i}{\sigma_H^2} + \sum_{j=1}^{J_i} (\sigma(\hat{\mu}_i) - \hat{z}_{ij}) = 0.$$

The left-hand side of the above expression is monotone increasing in  $\hat{\mu}_i$ , and so this equation has a unique solution. We are not aware of a closed-form solution to (4.7); however, Newton’s method works well and is easy to implement for this problem.

4.1. *Final answer.* After iterating EM to convergence, we obtain final estimates for the posterior probabilities

$$(4.8) \quad \hat{\rho}(k) = \frac{1 + \sum_{i,j} \hat{z}_{ij} 1(\{X_{ij} = k\})}{2 + \sum_{i,j} 1(\{X_{ij} = k\})}.$$

*A single tuning parameter.* The only tuning parameter in the update steps defined above is the noise variance  $\sigma_H^2$  of the human evaluation estimate  $\text{HE}_i$ . As the form of (4.7) makes clear, however,  $\sigma_H^2$  only enters into the model as a way to balance the relative importance of  $\text{HE}_i$  and the  $\hat{z}_{ij}$  in estimating  $\hat{\mu}_i$ ; thus, we expect our model to be fairly robust to misspecification of this parameter. In our experiments, we just used  $\text{WH} := 1/\sigma_h^2 = 10$ , where WH stands for “weight given to human evaluation.”

*Standard error estimates.* In our experiments, we obtained error bars for the parameter estimates by grouped subsampling: we generated random subsamples by randomly selecting  $I/2$  groups without replacement and then looked at how much our point estimates varied when trained on different subsamples. In general, half-sampling without replacement is closely related to full sampling with replacement [e.g., Efron (1983), Politis, Romano and Wolf (1999)]. In this problem, we chose to use subsampling instead of a nonparametric bootstrap [Efron and Tibshirani (1993)] because we did not want to have duplicate groups with identical click distributions.

**5. Simulation experiments.** We begin our empirical evaluation of weakly supervised clustering methods with some simulation examples; Section 6 has larger real-world examples.

The number of clicks per group can have a large impact on the relative performance of different methods. In Figure 4, we show examples with  $J_i = 5$  and  $J_i = 100$  clicks per group. With 5 clicks per group, both the method of moments estimate and our latent variables model perform reasonably well;

(a)  $J_i = 5$  clicks per group(b)  $J_i = 100$  clicks per group

FIG. 4. *Simulation example with many clicks per group. We have  $I = 500$  groups with  $J_i = 5$  or 100 clicks each; behaviors are divided into 15 bins with posterior probabilities of happiness given by the thick black line. The data was generated with  $\sigma_H = 0.5$ ; the  $\mu_i$  themselves were independently drawn from  $\mathcal{N}(0, 1)$ . For the latent variables model, we used  $WH = 10$ . Error bars are 1 SD in each direction and illustrate instability across 50 simulation runs.*

the naive estimate that directly hard-assigns cluster memberships underfits badly.

When there are relatively few clicks per group, weak supervision is important: if we set  $WH = 0$  and only use the human evaluation data for initialization, our latent variables model is prone to overfitting and exagger-

ating the dynamic range of posterior probabilities. Using a nonzero value of  $WH$  fixed this problem (we used  $WH = 10$ ).

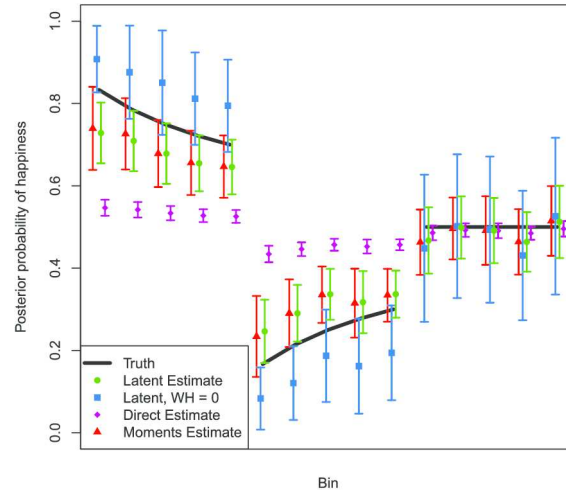
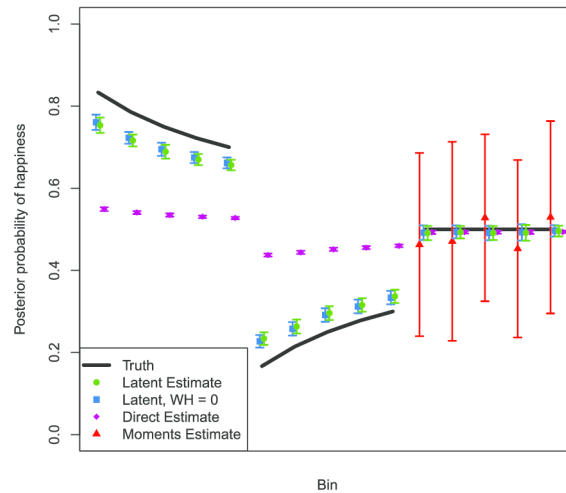
The 100 clicks per group example looks quite different. First of all, almost paradoxically, the method of moments estimate appears to have gotten much worse as we added more data; estimates for the first 10 bins are not even contained in the  $[0, 1]$  interval and so do not fit into the plot. We propose an explanation for this surprising phenomenon in Section 7.2.

Meanwhile, both latent variables procedures perform well. With many clicks per group, the importance of the human evaluation  $HE_i$  after initialization appears to fade away, and if we start off the EM algorithm at a good spot, it can get itself to a desirable solution without further guidance from the weak supervision; see Section 7.1 for more discussion.

**6. Real-world experiments.** In Section 6.2, we apply our method to the problem that motivated our research: distinguishing satisfied from unsatisfied clicks based on click-level behaviors. However, due to confidentiality concerns, we need to present our results at a high level and are not able to share details such as feature names.

To provide more insight into our method, we begin by presenting an analysis of publicly available data from the 1984 presidential election using our method. We assume a setting where we do not have access to data on individual votes and need to rely on aggregated state-level election results. Since the available labels are coarser than the signal we want to fit, we need to do weakly supervised clustering to learn about individual voter-level characteristics. Although this application may appear quite different from the rest of the examples we discuss, the underlying statistical task is very similar. When constructing this example, we tried to make our analysis mirror the analysis from Section 6.2 as closely as possible.

6.1. *Weakly supervised clustering of voter demographics.* In this example, we want to identify voter groups that favored the Mondale/Ferraro ticket over Reagan/Bush in the 1984 US presidential election and to build a model of the form

$$(6.1) \quad \mathbb{P}[\text{Vote for Reagan}] \sim f(\text{Demographic Information}).$$

If we had access to a joint data set that records both individual votes and individual demographic information, we could easily fit (6.1) by logistic regression. Here, however, we assume that we do not have access to such a data set and that, for example, we only have access to (1) a census data set with individual-level demographic information that does not record voting intent, and to (2) state-level aggregated election results. The problem of fitting (6.1) then becomes a weakly supervised clustering problem where, using notation from Figure 2, the  $\mu$  represent state-level election results, the  $X$

are rows in the census data set, and the  $Z$  are inferred votes corresponding to the  $X$ .

More specifically, we base our analysis on a vector  $\pi$  which records the fraction of votes for Reagan in each state, and a design matrix  $X$  with the following per-voter information:

- State;
- Annual income  $\in \{1 : [0, \$12,500); 2 : [\$12,500, \$25,000); 3 : [\$25,000, \$35,000); 4 : [\$35,000, \$50,000); 5 : [\$50,000, \infty)\}$ ;
- Union membership  $\in \{\text{voter is a member of labor union, voter has a family member who is a member of a labor union, voter has no family members who are labor union members}\}$ ;
- Race  $\in \{\text{black, white, other}\}$ .

The matrix  $X$  has information on 8082 voters spread across 42 states, with a median of 129.5 voters per state. The demographic factors have the following frequencies: income  $\{1342, 2331, 1897, 1473, 1039\}$ , Union membership  $\{1238, 1001, 5843\}$ , and race  $\{930, 6869, 283\}$ .

We constructed our data set based on election day exit-poll data collected by CBS News and The New York Times following the 1984 US presidential election, available from Roper Center for Public Opinion Research at the University of Connecticut (USCBSNYT1984-NATELEC). We removed entries for people who did not vote for either Mondale or Reagan or who had missing data; before doing this, the original data set had 9174 rows.<sup>3</sup>

Results are presented in Table 1 for both the direct method from Section 3.1 and our latent variables approach. In terms of cross-validation error, we see that the latent variables method is almost on par with an oracle that gets to see individual votes, whereas the direct method is not much better than just always predicting the global mean. Note that for 0–1 error we did not tune the decision threshold and just set it to even odds.<sup>4</sup>

Figure 5 shows the predictions made by both the direct and latent methods. We observe that the latent predictions have a much wider dynamic range than the direct ones, which can be helpful if we want to interpret the

---

<sup>3</sup>Of course, it would have been closer to the spirit of our example to construct the data set  $(X, \pi)$  based on actual census data and aggregated voting information. For the purpose of testing our methodology, however, using an exit poll data set is advantageous: since we know what the actual votes were, we can both check if our algorithm is making reasonable voter-level predictions and compare its performance to an oracle model that gets to use information about individual votes.

<sup>4</sup>We do not report results for the method of moments approach, as it did not work at all here. In light of the examples from Section 5, this is not very surprising, as here we have few states and many voters per state. For the latent variables method, we set  $\text{WH} = \infty$  because our state-level vote averages were accurate enough that we could safely fix the  $\mu_i$ .

TABLE 1

*Results for predicting individual votes. The “null model” is the model-free baseline, which just guesses that every voter has the same probability of voting for Reagan. The direct and latent models are as described in Sections 3.1 and 4. The oracle model gets to see individual votes during training; this is equivalent to training a direct model with a separate group for each voter. With the exception of the null, all error rates are cross-validated: we repeatedly trained each model on a random sample of 21 states, and then evaluated the error rate on the remaining 21 states*

	<b>Null model</b>	<b>Direct</b>	<b>Latent</b>	<b>Oracle</b>
Mean classification error	0.41	0.39	0.33	0.31
Root mean squared error	0.49	0.48	0.46	0.45

model predictions and get an intuition for effect sizes. The latent variables predictions are also much more closer to the gold-standard oracle predictions shown in the lowest panel. The mean-squared difference between the latent variables model and the oracle model, averaged over all 45 available factors, was 0.02; in comparison, the mean-squared difference between the naive and oracle models was 0.08.

*6.2. Finding happy clicks.* The research developed in this paper was motivated by a problem faced by an internet company. In the terminology of our running example, we had data on millions of click-level behaviors spread across thousands of search results. We then asked a panel of annotators to estimate, for each group, whether or not a click in a given group would likely lead to satisfaction. Our goal was to learn to identify “happy clicks” based on click-level behavior; in other words, we wanted to perform a weakly supervised clustering for click-level happiness.

The distribution of clicks was heavily skewed. To avoid our result being dominated by a few unusually large groups, we down-weighted clicks in large groups such that the effective number of clicks in any group was at most  $M$ , where  $M \approx 500$ . After down-weighting, the average number of clicks per group was around one hundred. Not down-weighting the biggest groups could lead to undesirable consequences, as it could cause us to overfit to certain websites: for example, if our training set contained a million clicks navigating to `facebook.com` and we did not down-weight them, we might easily overreact to special behaviors associated with Facebook clicks.

Results of our analysis are presented in Figure 6. For confidentiality reasons, we cannot publish feature names or axis scales. The groups are split into two different classes (A and B), for which we performed analysis separately. We described click-level behavior using a full cross of three different factors, resulting in  $5 \times 3 \times 2 = 30$  bins. Each point represented in Figure 6 was fit separately; the fact that these points seem to fit along smooth curves suggests that our method is capturing a real phenomenon.

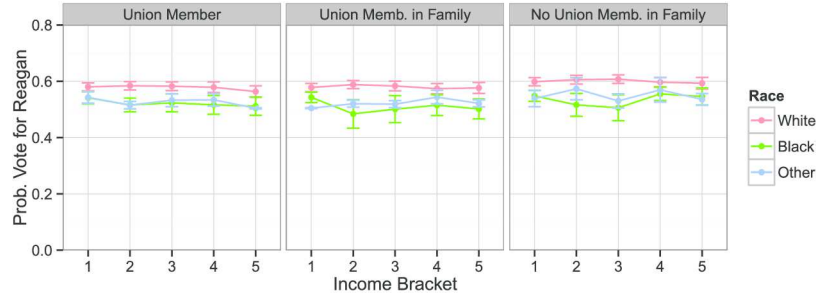

(a) Fit by direct hard assignment of labels

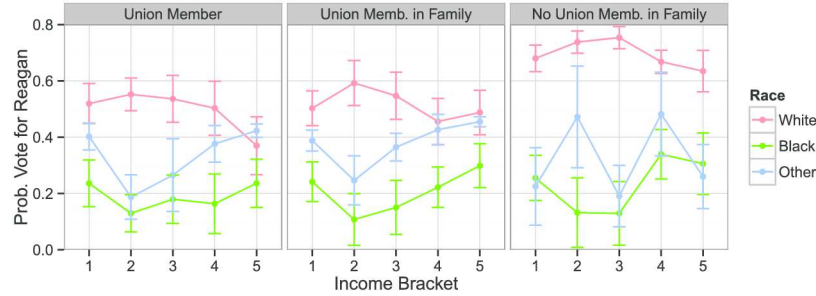

(b) Fit by latent variables modeling

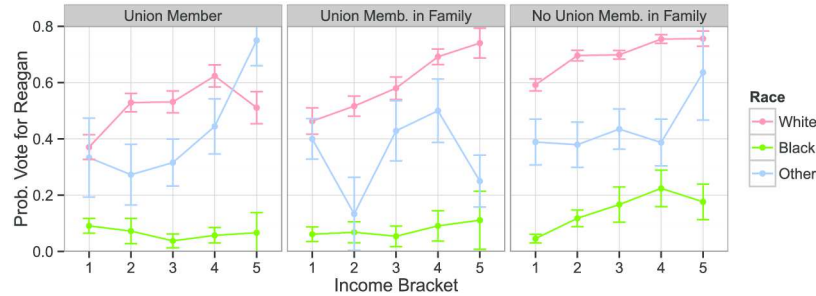

(c) Oracle fit

FIG. 5. Comparison of models fit by the direct method and the latent variables method on the voter demographic example described in Section 6.1. In the last panel, we also display the fit produced by an oracle that has access to the hidden individual labels. All error bars are 1 SE in each direction and were obtained by subsampling. We note that there are only 53 voters in the “Union member  $\times$  Other race” group and 29 voters in the “Union memb. in family  $\times$  Other race” group, so these two curves should not be interpreted too closely.

Latent variables modeling allowed us to discover multiple relationships between click-level behavior and happiness, some of which confirmed our intuitions and others which surprised us. In terms of the obfuscated labels, we found that (1) Happiness generally increases with level, but with diminishing returns; (2) Red clicks are systematically more indicative of happiness

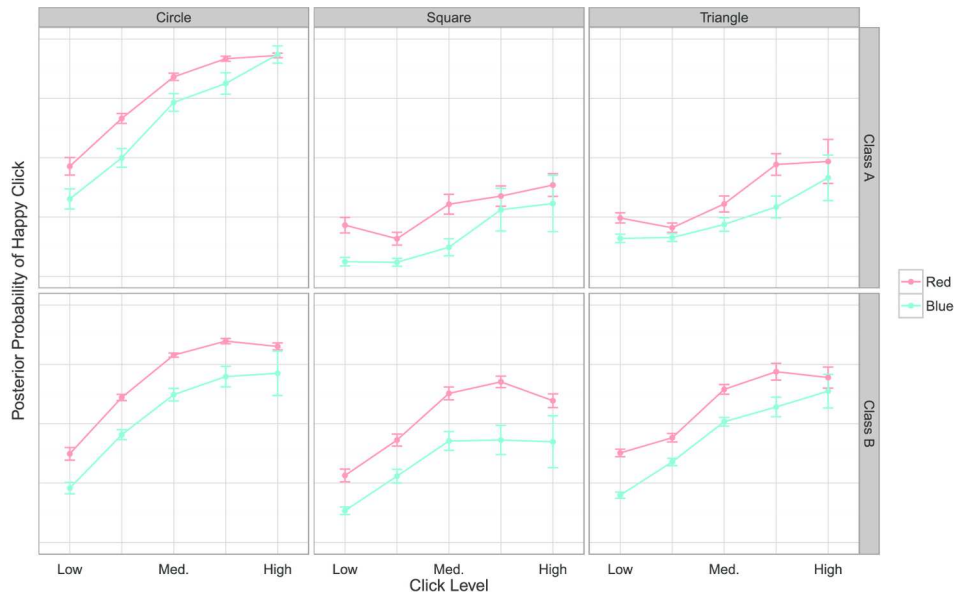

FIG. 6. Results of a real-world weakly supervised clustering analysis described in Section 6.2, using the full latent variables model trained by EM. The groups are divided into two classes (A and B) that were fit separately; click-level behaviors are described by 30 buckets obtained by crossing level, shape and color features (the true feature names have been obfuscated for confidentiality reasons). All error bars are 1 SE in each direction and were obtained by subsampling. We set the human evaluation tuning parameter to  $WH = 10$ .

than blue clicks; and (3) Circular clicks are generally happier than square or triangular ones, but this distinction is much more pronounced in Class A than in Class B. Of these facts, (1) was roughly expected and (2) had been conjectured, although we were not expecting such a strong effect, but (3) came largely as a surprise. We thought that Class A clicks should uniformly be happier than Class B clicks, but it turns out that this relation only holds for circles.

In Figures 7 and 8, provided at the end of the paper, we show the results of applying the naive and method of moments estimates to this problem. These estimates, respectively, under- and overfit the signal so badly that they did not allow us to discover any of the key insights described above.

**7. Discussion.** The simulation results from Section 6 suggested some interesting relationships between the number of clicks per group and the relative performance of various methods. Here, we present some possible explanations for these relationships and also discuss potential alternatives to our method.



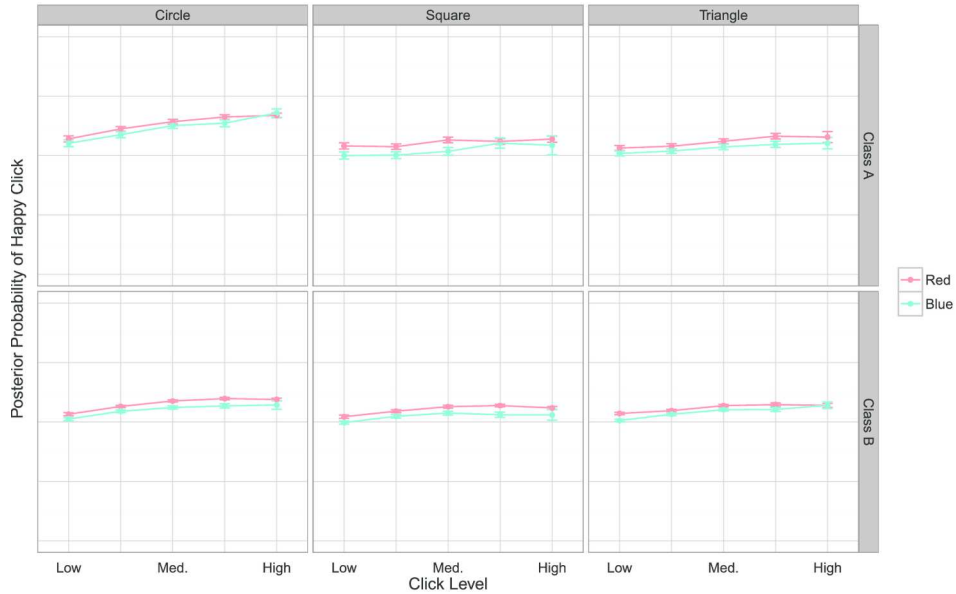

FIG. 7. Same analysis as that presented in Figure 6, except fit using the naive method from Section 3.1. The range of the y-axis is the same as in Figure 6; we see that the naive method loses almost all of the dynamic range of the full model.

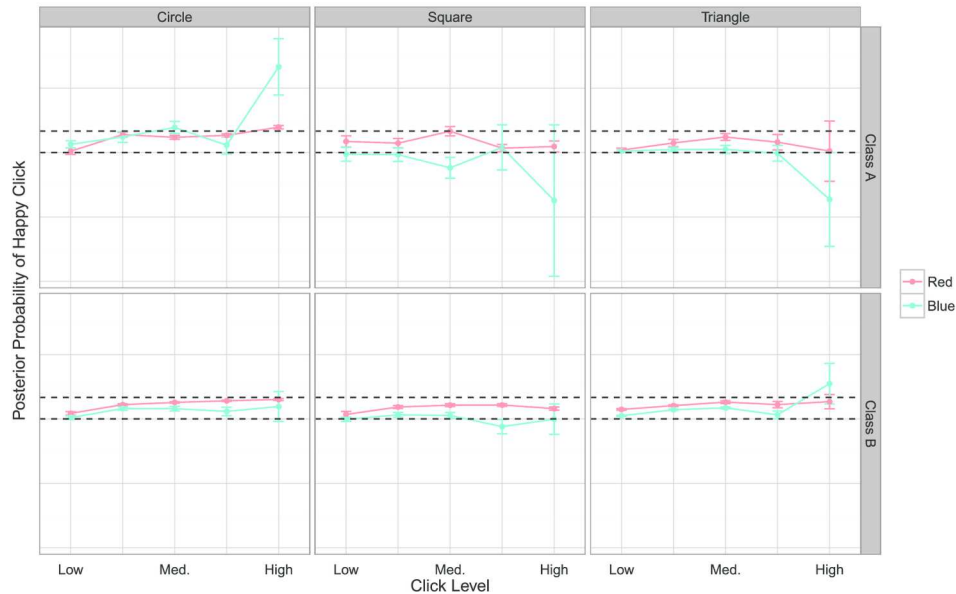

FIG. 8. Same analysis as that presented in Figure 6, except fit using the method of moments estimate from Section 3.2. The dashed lines indicate the y-axis limits from Figure 6. The method of moments estimate appears to be severely unstable here.

7.1. *The importance of human evaluation.* The human evaluation data  $\{\text{HE}_i\}$  enters into our EM-algorithm in two locations: initialization, and the M-step for  $\hat{\mu}_i$ . Good initialization is important, as it gives the algorithm guidance about what kind of clustering to look for. From our simulations, however, it appears that keeping  $\text{HE}_i$  around for the M-steps is important when the number of clicks per group is small, but less important when the number of clicks is large.

This phenomenon can be understood by looking at the M-step equation (4.7). We see that the relative importance of  $\text{HE}_i$  relative to the  $\hat{z}_{ij}$  in updating  $\hat{\mu}_i$  scales inversely with the number of clicks  $J_i$  in group  $i$ . Thus,  $\text{HE}_i$  provides useful support for updating  $\hat{\mu}_i$  during the M-step when  $J_i$  is small. When  $J_i$  is large the contribution of  $\text{HE}_i$  during the M-step gets washed out, and our algorithm drifts more and more toward an unsupervised clustering algorithm that uses human evaluation data for initialization only. It appears that, in practice, with enough data per group, human evaluation is only required to start the algorithm off near the right mode.

7.2. *Understanding the method of moments.* In our simulations, we found the method of moments estimate to perform *less* well as we added more clicks per group. Although this may seem like a highly unintuitive result, we can attempt to understand it using classical results about the connection between noisy features and regularization.

The design matrix  $\Omega$  used to fit the method of moments estimator in (3.3) records the fraction of clicks in each group that appeared in a given bucket. The more clicks we have per group, the closer each row of  $\Omega$  gets to the true underlying behavior distribution for each group. If the number of clicks per group is small, then the rows of  $\Omega$  are effectively contaminated by mean-zero noise.

It is well known that training linear regression with a design matrix corrupted by mean-zero noise is equivalent to training with a noiseless design matrix and adding an appropriate ridge (or  $L_2$ ) penalty to the objective [Bishop (1995)]; this connection between noising and regularization has even been used to motivate new  $L_2$ -like regularizers by emulating noising schemes [van der Maaten et al. (2013), Wager, Wang and Liang (2013)].

Now, if our model is correct, the noiseless limit of the rows of  $\Omega$  are in a 2-dimensional space spanned by the happy and sad behavior distributions. Thus, in the absence of noise, the regression problem implied by our method of moments estimate is highly ill-conditioned. But, when we only have few clicks per row, we are effectively adding noise to  $\Omega$  and this noise is acting as a ridge penalty. Thus, for the method of moments estimator, throwing away data can be seen as a (rather roundabout) way of fixing numerical ill-conditioning.

7.3. *Discriminative weakly supervised classification?* For our latent variables approach, we chose to treat  $X$  as a random variable depending on  $Z$  and to model  $\mathcal{L}(X|Z)$ . An alternative choice would be to set up a discriminative model where we condition on  $X$  and model  $\mathcal{L}(Z|X)$ ; in terms of the plate diagram from Figure 2, this would amount to swapping the direction of the arrow from  $Z$  to  $X$ .

This class of models has been studied in detail in the context of logistic regression with unreliable class labels [e.g., Copas (1988), Magder and Hughes (1997), Yasui et al. (2004), Kück and de Freitas (2005)]: given a data set of  $(X, Y)$ -pairs with  $Y \in \{0, 1\}$ , the authors posit that the observed class labels  $Y$  are potentially erroneous, but that there exist unobserved true labels  $Z \in \{0, 1\}$  such that  $(X, Z)$  are drawn from a logistic regression model and  $\mathbb{P}[Y = Z] = 1 - \varepsilon$ . Formally, this results in a probabilistic model where  $\mathcal{L}(Z|X) = \text{Bernoulli}(\sigma(\beta \cdot X))$  for some parameter vector  $\beta$ , and then  $\mathcal{L}(Y|Z) = \text{Bernoulli}(\varepsilon + Z(1 - 2\varepsilon))$ .

The main difference between the noisy class labels problem and our problem is that the former has a natural model for  $\mathcal{L}(Y|Z)$ , whereas in our setup  $\mu$  does not depend causally on  $Z$ . In our motivating examples we think of  $\sigma(\mu)$  as (a potentially noisy estimate of) the *population* mean of the  $Z$ , such that  $\mu$  is conditionally independent of  $Z$  given the population. Thus, our problem statement does not fit directly into the framework of Copas (1988) and others.

**8. Conclusion.** Classification problems where training labels are much coarser-grained than the signal we are trying to fit arise naturally in many applications. We showed how they can be formalized as weakly supervised clustering problems and presented three approaches to fitting them, including a latent variables model that worked well in our experiments. In both the elections application from Section 6.1 and the real-world problem that originally motivated our research (Section 6.2), our method enabled us to gain qualitatively richer insights than baselines that rely on hard assignment of labels or moment matching. An interesting topic for further work would be to study the information loss from only having access to weakly instead of fully labeled data.

**Acknowledgment.** The authors are grateful to Nick Chamandy, Henning Hohnhold, Omkar Muralidharan, Amir Najmi, Deirdre O’Brien, Wael Saloum, Julie Tibshirani and Brad Efron for many helpful discussions, and to their AOAS editor, Brendan Murphy, for constructive feedback on earlier versions of this manuscript.

## REFERENCES

- AGRESTI, A. (2002). *Categorical Data Analysis*, 2nd ed. Wiley, New York. [MR1914507](#)
- BISHOP, C. M. (1995). Training with noise is equivalent to Tikhonov regularization. *Neural Comput.* **7** 108–116.
- BISHOP, C. M. and NASRABADI, N. M. (2006). *Pattern Recognition and Machine Learning*. Springer, New York.
- BLEI, D. M., NG, A. Y. and JORDAN, M. I. (2003). Latent Dirichlet allocation. *J. Mach. Learn. Res.* **3** 993–1022.
- BUCKLIN, R. E. and SISMEIRO, C. (2009). Click here for Internet insight: Advances in clickstream data analysis in marketing. *J. Interact. Market* **23** 35–48.
- COPAS, J. B. (1988). Binary regression models for contaminated data. *J. Roy. Statist. Soc. Ser. B* **50** 225–265. [MR0964178](#)
- DEMPSTER, A. P., LAIRD, N. M. and RUBIN, D. B. (1977). Maximum likelihood from incomplete data via the EM algorithm. *J. Roy. Statist. Soc. Ser. B* **39** 1–38. [MR0501537](#)
- EFRON, B. (1983). Estimating the error rate of a prediction rule: Improvement on cross-validation. *J. Amer. Statist. Assoc.* **78** 316–331. [MR0711106](#)
- EFRON, B. and TIBSHIRANI, R. (1993). *An Introduction to the Bootstrap*. CRC press, Boca Raton, FL.
- FRALEY, C., RAFTERY, A. E., MURPHY, T. B. and SCRULLA, L. (2012). MCLUST version 4 for R: Normal mixture modeling for model-based clustering, classification, and density estimation. Technical report.
- GORDON, A. D. (1999). *Classification*. Chapman & Hall, London.
- HOFMANN, T. (2001). Unsupervised learning by probabilistic latent semantic analysis. *Mach. Learn.* **42** 177–196.
- HUNTER, D. R. and LANGE, K. (2004). A tutorial on MM algorithms. *Amer. Statist.* **58** 30–37. [MR2055509](#)
- KÜCK, H. and DE FREITAS, N. (2005). Learning about individuals from group statistics. In *Proceedings of the 21st Conference on Uncertainty in Artificial Intelligence* 332–339. AUAI Press, Arlington, VA.
- LANGE, K., HUNTER, D. R. and YANG, I. (2000). Optimization transfer using surrogate objective functions. *J. Comput. Graph. Statist.* **9** 1–59. [MR1819865](#)
- LEVY, S. (2011). *In the Plex: How Google Thinks, Works, and Shapes Our Lives*. Simon and Schuster, New York.
- MAGDER, L. S. and HUGHES, J. P. (1997). Logistic regression when the outcome is measured with uncertainty. *American Journal of Epidemiology* **146** 195–203.
- POLITIS, D. N., ROMANO, J. P. and WOLF, M. (1999). *Subsampling*. Springer, New York. [MR1707286](#)
- QUADRIANTO, N., SMOLA, A. J., CAETANO, T. S. and LE, Q. V. (2009). Estimating labels from label proportions. *J. Mach. Learn. Res.* **10** 2349–2374. [MR2563985](#)
- RUEPING, S. (2010). SVM classifier estimation from group probabilities. In *Proceedings of the 27th International Conference on Machine Learning* 911–918.
- SCULLEY, D., MALKIN, R. G., BASU, S. and BAYARDO, R. J. (2009). Predicting bounce rates in sponsored search advertisements. In *Proceedings of the 15th ACM SIGKDD International Conference on Knowledge Discovery and Data Mining* 1325–1334. ACM, New York.
- SURDEANU, M., TIBSHIRANI, J., NALLAPATI, R. and MANNING, C. D. (2012). Multi-instance multi-label learning for relation extraction. In *Proceedings of the 2012 Joint Conference on Empirical Methods in Natural Language Processing and Computational Natural Language Learning* 455–465. Association for Computational Linguistics, Stroudsburg, PA.

- TÄCKSTRÖM, O. and McDONALD, R. (2011a). Discovering fine-grained sentiment with latent variable structured prediction models. In *Advances in Information Retrieval* 368–374. Springer, Berlin.
- TÄCKSTRÖM, O. and McDONALD, R. (2011b). Semi-supervised latent variable models for sentence-level sentiment analysis. In *Proceedings of the 49th Annual Meeting of the Association for Computational Linguistics: Human Language Technologies. Short Papers, Volume 2* 569–574. Association for Computational Linguistics, Stroudsburg, PA.
- TOUTANOVA, K. and JOHNSON, M. (2007). A Bayesian LDA-based model for semi-supervised part-of-speech tagging. In *Advances in Neural Information Processing Systems* 1521–1528. Curran Associates, Red Hook, NY.
- VAN DER MAATEN, L., CHEN, M., TYREE, S. and WEINBERGER, K. Q. (2013). Learning with marginalized corrupted features. In *Proceedings of the 30th International Conference on Machine Learning* 410–418.
- WAGER, S., WANG, S. and LIANG, P. (2013). Dropout training as adaptive regularization. In *Advances in Neural Information Processing Systems*. Curran Associates, Red Hook, NY.
- XING, E. P., JORDAN, M. I., RUSSELL, S. and NG, A. (2002). Distance metric learning with application to clustering with side-information. In *Advances in Neural Information Processing Systems* 505–512. Curran Associates, Red Hook, NY.
- XU, G., YANG, S.-H. and LI, H. (2009). Named entity mining from click-through data using weakly supervised latent Dirichlet allocation. In *Proceedings of the 15th ACM SIGKDD International Conference on Knowledge Discovery and Data Mining* 1365–1374. ACM, New York.
- YASUI, Y., PEPE, M., HSU, L., ADAM, B.-L. and FENG, Z. (2004). Partially supervised learning using an EM-boosting algorithm. *Biometrics* **60** 199–206. [MR2044116](#)

S. WAGER  
DEPARTMENT OF STATISTICS  
STANFORD UNIVERSITY  
STANFORD, CALIFORNIA 94305  
USA  
E-MAIL: [swager@stanford.edu](mailto:swager@stanford.edu)

A. BLOCKER  
N. CARDIN  
GOOGLE, INC.  
MOUNTAIN VIEW, CALIFORNIA 94043  
USA  
E-MAIL: [awblocker@google.com](mailto:awblocker@google.com)  
[niallc@google.com](mailto:niallc@google.com)