

Cache Performance Study of Portfolio-Based Parallel CDCL SAT Solvers

Roberto Asín^{*}, Juan Olate^{**}, and Leo Ferres^{**}

^{*}Department of Computer Engineering, Faculty of Engineering, Universidad Católica de la Santísima Concepción, Chile, rasin@ucsc.cl

^{**}Department of Computer Science, Faculty of Engineering, Universidad de Concepción, Chile, {juanolate,lferres}@udec.cl

April 27, 2022

Abstract

Parallel SAT solvers are becoming mainstream. Their performance has made them win the past two SAT competitions consecutively and are in the limelight of research and industry. The problem is that it is not known exactly what is needed to make them perform even better; that is, how to make them solve more problems in less time. Also, it is also not known how well they scale in massive multi-core environments which, predictably, is the scenario of coming new hardware. In this paper we show that cache contention is a main culprit of a slowing down in scalability, and provide empirical results that for some type of searches, physically sharing the clause Database between threads is beneficial.

Keywords: Satisfiability; Parallel SAT solving; Parallel processing; Shared-memory SMP

1 Introduction

In this paper, we study the effect of cache performance on the scalability of parallel solvers of the satisfiability problem in hierarchical-memory, symmetric multi-processing systems; systems with more than one processor that share memory. We find this topic important for three reasons:

First, in the last years, parallel SAT solvers (henceforth, pSATs) have been performing at the top of the SAT Competitions¹ (in 2011, all three wall-clock time winners of the competition were parallel solvers). Also in 2011, pSATs and sequential SAT solvers were grouped into a single competition track, which shows the widespread interest in pSATs by research and industry. This appeal stems in part from the inherently interesting properties of parallel algorithms,

¹<http://baldur.iti.uka.de/sat-race-2010/>, <http://www.satcompetition.org/>

but also because of the need of the community to do better in new application domains and handle even larger and more complex CNF formulas in shorter times, taking advantage of modern hardware.

Second, instead of increasing clock performance, chip manufacturers are investing heavily on multicore architectures to improve performance and lower power consumption (AMD released the 8-core Opteron 3260 EE in late 2011, and Intel did the same with the Xeon E5-2650, and its low power version, the Xeon E5-2650L in early 2012). As Herb Sutter put it, “the free lunch is over” [Sut05], and by this he meant that software in general will not be getting any faster by simply relying on faster processor clocks, but by relying on how software scales in multicore systems.

Finally, modern memory architectures are not flat Processor \leftrightarrow RAM architectures, but a hierarchy of fast-but-small to slower-but-large memories with latencies and capacities varying from $0.5ns$ access to $32Kb$ memories in the L1 (first level) cache, to tens of nanoseconds for megabyte-large memories like the L3 cache (usually the last level, LL cache), to $100ns$ for gigabyte-sized access times to memory such as main memory DDR ram. Hierarchical memory architectures have a strong impact on the performance of sequential software (e.g., in a row-major representation of a matrix, memory transfers may be in the order of the input divided by the size of the cache line, while memory transfers for column scanning are in the order of the square of the input). This impact is equal or bigger in the case of parallel processes since, for most architectures, the cores in the system share some level of cache memory.

Given the three reasons above, in this paper we are concerned with the following questions: how do pSATs scale in hierarchical-memory multicore architectures? What is the effect of cache performance? Our case study is the winner of the 2011 SAT Competition, **plingeling**, a portfolio-based pSAT solver [Bie11]. The first experiment tested a *modified plingeling* on a 40-core machine (four ten-core processors), varying the number of threads. This instance of **plingeling** was modified so that, for each *worker thread*, the *same search* would be performed (i.e. same strategies, starting parameters and without lemma exchanging). This allowed us to measure the impact of running p threads on the same physical CPU. In Figure 1, we see how the modified **plingeling**’s performance decays sharply (around 30% on average, up to maximum of $\sim 200\%$) when several solver instances are executed on the same processor. This happens even though, in principle, instances do not logically share any resources other than the common process address space. On the contrary, we would have expected that all instances would perform similarly, plus or minus a small time fraction. This is in fact what happens when **plingeling** is run in four different cores of four different chips, in different and even in the same machine.

In order to find the reason of the performance decay, we have developed a simple portfolio-based SAT solver (which we have called **AzuDICI**) that allows us to both replicate the behavior of **plingeling**, and then also experiment with alternative scenarios (such as physically sharing information among threads) in order to take measures towards the improvement of its cache performance. It is important to highlight that our SAT solver does not compare to high-

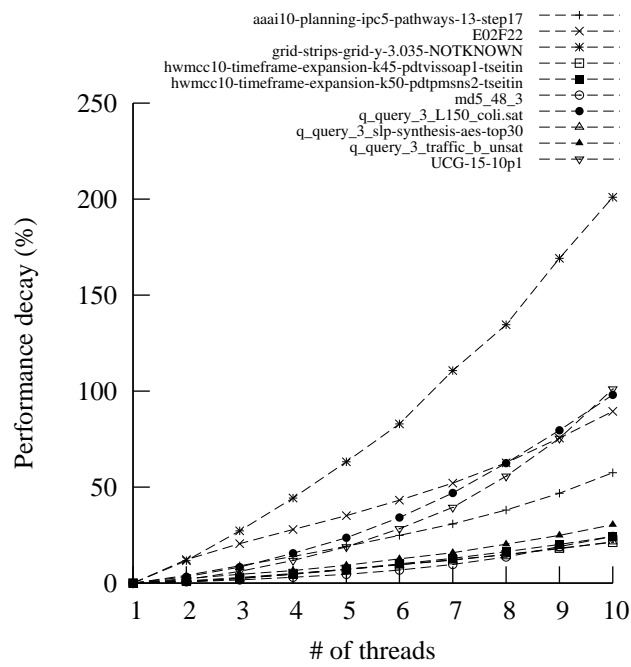

Figure 1: Performance decay of `plingeling` when run over 10 cores on a single processor using several standard benchmarks (their long names are in the legend.)

performance current state-of-the-art solvers as is `plingeling` itself. `AzuDICI` serves as a useful tool to test and analyze the behavior of portfolio-based pSAT solvers.

The paper is structured as follows, highlighting our contributions in the relevant sections: in Section 2 we introduce the topic; that is, the general problem of SAT solving and computational *sequential* SAT solving (Section 2.1) and parallel SAT solving 2.2. Section 3 shows the cache performance of `plingeling`, a state-of-the-art portfolio-based SAT solver, when varying number of executing threads. We show how cache contention significantly (and negatively) impacts the performance of portfolio-based parallel SAT solvers. We conclude here that pSAT solvers do not scale satisfactorily in shared-memory parallel architectures. In Section 4, we introduce `AzuDICI`, a “simple” portfolio-based pSAT solver that implements several levels of physical clause sharing. We also report the results of several experiments that compare the cache performance of these configurations, showing how physical clause sharing significantly helps certain configurations (when all threads are executing the same search) while either slightly or no help is observed when pSAT solvers threads perform different searches. Finally, Section 5 closes the paper with some discussion of the future of parallel SAT solving, situate our work in the context of what has been done so far, and point the way for future work.

2 Preliminaries

2.1 SAT and (Sequential) SAT solvers

Let V be a fixed finite set of *propositional variables*. If $v \in V$, then v and $\neg v$ are *literals* of V . The *negation* of a literal l , written $\neg l$, denotes $\neg v$ if l is v , and v if l is $\neg v$. A *clause* is a disjunction of literals $l_1 \vee \dots \vee l_n$. A (CNF) *formula* is a conjunction of one or more clauses $C_1 \wedge \dots \wedge C_n$. A (partial truth) *assignment* M is a set of literals such that $\{v, \neg v\} \subseteq M$ for no v . A literal l is *true* in M if $l \in M$, is *false* in M if $\neg l \in M$, and is *undefined* in M otherwise. A clause C is true in M if at least one of its literals is true in M . It is false in M if all its literals are false in M , and is undefined in M otherwise. A formula F is true in M , or *satisfied* by M , if all its clauses are true in M . In that case, M is a *model* of F . If F has no models then it is *unsatisfiable*.

The problem we are interested in is the *SAT problem*: given a formula F , to decide whether there exists a model of F or not. Since there exists a polynomial transformation (see [Tse68]) from any arbitrary formula to an equisatisfiable CNF one, we will assume w.l.o.g. that F is in CNF.

A program that solves this problem is called a *SAT solver*. The Conflict-Driven-Clause-Learning (CDCL) algorithm is nowadays at the basis of most state-of-the-art SAT-solvers [AS09, Bie10, SNC09]. This algorithm has, at its roots, the very simple DPLL algorithm [DLL62]. Thanks to work done mainly in [JS97, MMZ⁺01, MSS99, ZS96, ES04a, Bie08], CDCL has evolved into an algorithm that allows modern SAT-solvers to handle formulas of millions of

variables and clauses. Algorithm 1 sketches the CDCL algorithm.

Algorithm 1: CDCL algorithm

```

Input  : Formula  $F = \{C_1, \dots, C_m\}$ 
Output: SAT OR UNSAT

1 status := UNDEF;
2 model := {};
3 dl := 0;
4 while status == UNDEF do
5   (conflict, model) := BCP(model, F);
6   while conflict  $\neq$  NULL do
7     if dl == 0 then
8       | return UNSAT;
9       lemma := CONFLICT_ANALYSIS(conflict, model, F);
10      F := F  $\wedge$  lemma;
11      dl := LARGEST_DL_OF_FALSE_LITS(lemma, model);
12      model := BACKJUMP_TO_DL(dl, model);
13      (conflict, model) := BCP(model, F);
14    if status == UNDEF then
15      | dec := DECIDE(model, F);
16      | dl := dl + 1;
17      | if dec = 0 then status := SAT model := model  $\cup$  { dec };
18 return status

```

Basically, the CDCL algorithm is a backjumping search algorithm that incrementally builds a partial assignment M over iterations of the *DECIDE* and *BCP* (Binary Constraint Propagation) procedures, returning *SAT* if M becomes a model of F or *UNSAT* if no such model exists.

The *DECIDE* procedure corresponds to a branching step of the search and applies when the unit propagation procedure cannot set any further literal to true (see below). When no inference can be done about which literals should be true in M , a literal l^{dl} is “guessed” and added to M in order to continue the search. Each time a new decision literal is added to M the *decision level* dl of the search is increased and we say that all literals in M after l^{dl} and before l^{dl+1} belong to decision level dl . For further reading about the *DECIDE* procedure, we refer to [MMZ⁺01, ES04b, PD07].

The *BCP* procedure applies when certain assignment M falsifies all literals but one, of an undefined clause C . So, if l is the undefined literal in C , in order for M to become a model of F , l must be added to M for C to be satisfied. This procedure is tested for every clause of the Formula and it ends when there is no literal left to add to M or when it finds a false clause. In the first case, *BCP* returns an updated model containing all such propagations and the search continues. In the second case it returns the falsified clause, which we call a *conflicting clause*.

Since BCP usually takes about 90% of the total running time of a typical modern SAT solver, many implementation techniques have been proposed to make it more efficient. The algorithm that is implemented in most current state-of-the-art SAT-solvers is known as the *two-watched literal scheme* [MMZ⁺01]. The underlying idea is that no clause with more than one literal will generate a unit propagation or become conflicting if at least two of its literals are undefined or, at least one of them is true. Hence, for each clause C , either C is true or the algorithm makes sure that two undefined literals exist. For this purpose, two non-false literals are watched in every clause. For every literal we keep a list of the clauses where it is being watched. As soon as some literal l becomes false in the assignment, we visit every clause C in its watch list. If the other watched literal l' of C is true, then C is satisfied and the invariant is preserved. Otherwise we must find a non-false literal different from l and l' to watch. If we do not succeed and l' is false, the clause is conflicting; if we do not succeed and l' is unassigned, we unit propagate l' . For a detailed review on BCP and how different implementations perform in hierarchical (cache) memory we refer to [ZM04].

Since many problems have a great percentage of binary clauses, many SAT solvers represent the set of binary clauses as a *graph of implications*. For each literal l , a list of implied literals (literals that must be true whenever l is in M) is stored. For example, the clause $l1 \vee l2$ is stored by adding $l2$ to the implications list of $\neg l1$ and so is $l1$ to the list of $\neg l2$. Thus, BCP with binary clauses becomes very efficient, since, to calculate the unit propagation of a literal $l \in M$, it suffices to go through its implications list and add every literal of the list to M . In the case that a given literal l' of the list is false, then a conflicting binary clause $\neg l \vee l'$ is found and second condition for BCP termination applies.

If BCP finds a conflicting clause, then two possibilities can apply. If the decision level of the search is zero (i.e. no decisions have been made) then the CDCL procedure returns UNSAT. If this is not the case, a *CONFLICT ANALYSIS* procedure is called. This procedure analyzes the cause of such conflict (i.e. determines which decisions have driven to the conflict) and returns a new clause (which we call a *lemma*) that is entailed by the original formula. Then, the algorithm backjumps to an earlier decision level dl' that corresponds to the highest $dl' < dl$ among the false literals in the lemma, and propagates with it. CONFLICT ANALYSIS works in such a way that, when backjumping and propagating with the lemma, the original conflict is avoided. The lemmas learned at CONFLICT ANALYSIS time are usually added to the formula in order to avoid similar conflicts and can also be deleted (when the formula is too big and they are no longer needed). For details of CONFLICT ANALYSIS, we refer to [MSS99, ZMMM01] and for lemma deletion heuristics to [BS97, GN02, AS09]. For a complete review of this algorithm as well as proofs over its termination and soundness we refer to [NOT06].

2.2 Parallel SAT solvers

Parallel SAT solvers are not as mature as sequential ones and it is still not clear which path to follow when designing and implementing such new solvers. In this section we will briefly present the two main approaches used in parallel SAT solvers for shared memory architectures². We mainly classify the parallel SAT solvers for shared memory architectures into two categories: *portfolio-approach* and search-space splitting solvers.

The main idea behind portfolio approach solvers is the fact that different strategies/parameters of CDCL sequential solvers or even different kinds of sequential solvers perform better for different families of SAT problems. In sequential CDCL SAT-solving, for example, there exist several parameters/strategies related to the algorithm’s heuristics for restarting, deciding or cleaning the clause database. Taking this into consideration, a portfolio approach is very straightforward: run a group of sequential solvers in different threads, each with different parameters and/or different strategies. This idea can be easily extrapolated to other non-CDCL SAT solvers. The time the portfolio-based parallel solver will take to solve the problem will be the time of the fastest thread in the group of solvers running in parallel. Differences between this kind of solvers lie in whether the clause database should be physically shared [KK11] or, otherwise, if each thread should have its own database. If this second approach is taken, it is possible to implement the solver so that its different threads interchange lemmas according to several policies: aggressively [HJS09] or selectively [Bie10] or avoiding communications between threads at all [Rou11].

Search space splitting solvers do not run different solvers in parallel, but run one solving instance that splits the search space into disjoint subspaces. A common strategy to divide the search space is to use *guiding paths* [ZBH96]. A guiding path is a partial assignment M in F , which restricts the search space of the SAT problem. A solver that divides its search space with guiding paths will assign threads to solve F with the given M of the guiding path the thread was assigned to. Once a thread finishes searching a guiding path with no success, it can request another to keep searching (we refer to [SLB09] for further explanations).

Both parallelization strategies (portfolio approach and search-space-splitting approach) were and are currently being applied to shared memory parallel computers (e.g. [Bie10]) as well as to distributed memory ones (e.g. [SLB09]). For a further review on shared memory parallel SAT solving, we refer to [MML12]

In what follows, we focus on solvers implementing the portfolio approach since this has reported the best results in recent papers and competitions.

2.3 Hardware and tools description

Since 2005, Intel has produced chips with more than one physical processing core in order to speed up execution by sidestepping the difficulty of producing

²The revision on SAT solving in distributed memory architectures is out of the scope of this paper.

chips with faster clocks. In these new machines, each core has private small memories (called L1 cache, and sometimes L2) and progressively bigger (but slower) shared memories (usually L2 and L3). These effectively constitute a “memory hierarchy” which needs to be kept coherent *to give the illusion of a single shared memory*. For instance, the architecture of two machines used to run the tests were:

- Machine *K*: a dual-processor 6-core Intel Xeon CPU (E5645) running at 2.40GHz, with a total of 12 physical cores. Hyperthreading was disabled. The computer runs Linux 3.0.0-15-server, in 64-bit mode.
- Machine *I*: a quad-processor 10-core Intel Xeon CPU (E7-4860) running at 2.27GHz, for a total of 40 physical cores. Hyperthreading was enabled, but we never ran our code in more than 40 cores (Cores 0-39) with the care that a process was always bind to an unassigned core. Each core has one processor unit (PU), with separate L1d (32KB) and L2 (256KB) caches. They share a 30MB L3 cache. Main memory is 256GB. The computer runs Linux 2.6.18-194, in 64-bit mode.

We used two testing computers for technical reasons. Since we were not the administrators of machine *I*, we did not have access to the tools we needed for some of the experiments. On the other hand, Machine *I* had more than three times the number of physical cores of Machine *K*, providing stronger results. In any case, in those experiments where results could be compared (those which measured relative time, for example), we made the effort to compare them, and their behavior was (in relative terms) always the same, rendering the results generalizable.

3 Cache performance without physical clause sharing

The `plingeling` program is a portfolio-based pSAT solver that has won the parallel-track of both the 2010 SAT Race³ and the 2011 SAT Competition⁴. Briefly, when `plingeling` is called, it launches several *worker* threads (operating system threads, such as POSIX threads) that differ in their random seeds, some heuristic values and the intensity of some formula preprocessing methods. Each worker performs its individual search separately and, whenever one of them finds a solution, it is reported and the other workers are interrupted. Regarding information sharing, each of `plingeling`'s workers maintain its own clause Database and they only exchange the Unitary Clauses they find during search.

In this Section, we report our experimentation with this state-of-the-art solver and carefully analyze its performance in Cache and the effect of such Cache-behaviour in the overall performance of the solver.

³<http://baldur.iti.uka.de/sat-race-2010/>

⁴<http://satcompetition.org/>

3.1 Modified plingeling

One of the advantages we assume of parallel computing is that the more cores we add, the better performance we will obtain. This should be also true for **plingeling**, since the only difference of adding more threads (assuming we have one thread per core) is that we will have a greater variety of solver strategies trying to solve the same problem, and also some logical clause sharing among threads. These are all valid assumptions in theory, but our empirical results show that increasing the number of threads also carries a considerable decrease in performance for portfolio solvers like **plingeling** due to cache misses. In what follows, we go into detail.

Multicore shared memory systems have their cores sharing the same last level cache (LLC) memory. The last level cache size in modern machines has few megabytes and is usually not enough to hold all the data required by a SAT instance. Therefore, there will be inevitably some communication between the LLC and the main memory. The time cost of communication between the CPU and the LLC cache is much lower than between the CPU and the main memory, so we would like to keep data transfers from main memory to a bare minimum.

Portfolio SAT solvers that only share clauses logically have to keep a complete database of clauses for each thread's use. So as we add more threads, the solver has greater needs of memory. But since usually all cores (in the same chip) share the same LLC, all threads will have a lower chance of finding their data in the LLC as we add more threads. In this scenario, what we would expect to observe, as we have in our experiments, is a considerable decrease in performance when adding threads, simply because we incur in more LLC cache misses when the amount of data to be manipulated by different threads increases. We do not usually appreciate this negative performance impact in these type of solvers, because different threads implement different SAT solving strategies, so the solving time will mostly depend on the fastest solving thread, shadowing the negative performance impact of copying the clause database in each thread.

For experimentation purposes, we modified **plingeling** in such a way that each thread did exactly the same search. For this, we initialized each thread with the same random seed, heuristic values and clause database. Furthermore, in order to keep them searching in the same way, we disabled clause sharing between threads (which in **plingeling** corresponds to disabling the interchange of found units) and assure that cleanup policies and algorithms were the same. In these experiments, we would expect, theoretically, that adding more threads would have no impact in the solving time, because all cores would be exactly making the same search with their own data. However, in practice, we found that the performance decay of having ten threads spread over ten cores ranged from about 21% (1.21 times slower) to 200% (3 times slower) of the total time one thread would take (Figure 1). Possible reasons for this behavior may be due to several factors in modern SMP architectures. However, sharing resources (such as the caches, communication and/or synchronization, or main memory) could be seen as the main suspects. To find out, we ran another experiment

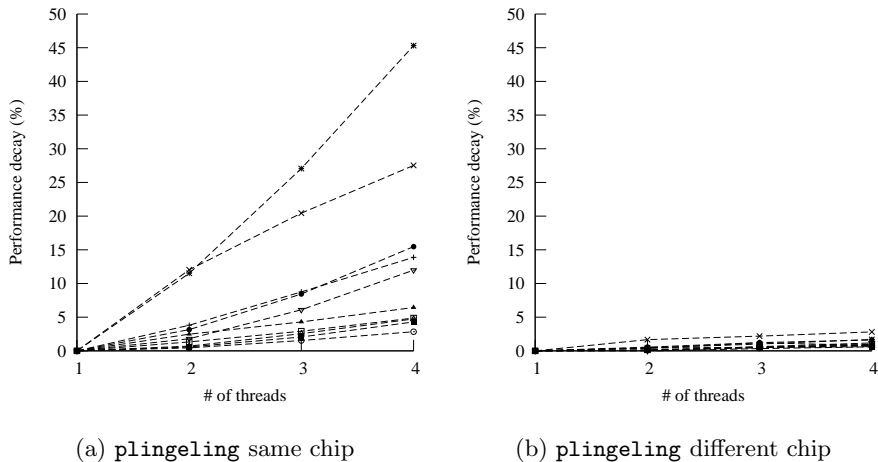

Figure 2: Modified `plingeling` performance decay

where a `plingeling` instance performing the same search with four threads was executed on different physical CPU *chips* (rather than cores), and, to compare, we ran the same experiment on four cores of the same CPU chip.

As can be seen in Figure 2b⁵, executing the solver on *different* CPU chips does not impact performance, while executing it on the *same* CPU chip incurs in a significant performance decay. According to the results above, the only shared resource that could impact performance when run in one chip is the LLC or Last Level Cache. To effectively measure the involvement of the LLC, we used the `perf` tool⁶. The `perf` tool is a hardware abstraction over hardware counters of the different CPU chips integrated in the Linux kernel to access profiling information on retired instructions, branch misprediction, and in particular for our purposes counting percentage of cache misses over cache hits (*LLC-load-misses*). As Figure 3 strongly suggests, the performance decay observable in Figure 1 is due to several solving threads *thrashing* the cache and thus wasting much more time retrieving their individual data from main memory than their single-threaded counterparts.

3.2 `plingeling` scalability

In this section, we provide an overview of how `plingeling` behaves at a larger scale. So far, thanks to the experiment above, we know that the more threads we add, the more cache hits/misses impacts negatively on performance. However, we also know that adding threads also adds new (and possibly successful) strategies. This results in a trade-off between cache contention versus portfolio-approach benefits. To find out where the trade-off equilibrium lies, we ran the

⁵This is Figure 1, showing only four cores

⁶perf.wiki.kernel.org. The `perf` utility was the reason why we could not use machine I, it was only added in kernel version 2.6.31.

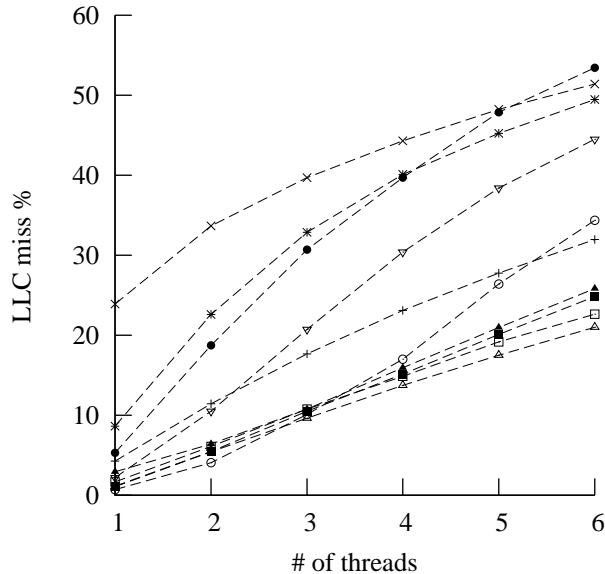

Figure 3: LLC statistics for modified `plingeling`

original `plingeling` over 208 standard benchmarks taken from past SAT Races and Competitions (see link above), varying the number of threads from one to ten on a single chip with 10 physical cores. These 208 benchmarks are the newly reported industrial/application benchmarks of competitions: the 2009 and 2011 SAT Competition and SAT Race 2010.

Figure 4 and Table 1 show that up until the fifth thread, scalability is good, but from then on, the number of solved problems and total time reaches a plateau. This means that `plingeling` cannot scale up on the number of cores sharing an LLC. It is important to notice that executing the same ten-thread solver in four different physical CPU chips solves more problems in less time, while executing a 40-thread solver (10 threads per chip) behaves worse than the four-threaded single-chip version. This effectively means that sharing cache among threads has a negative impact in the overall behavior of modern portfolio-approach-based parallel SAT solvers.

4 Cache Performance with physical clause sharing

4.1 AzuDICI

It is clear that the problem with cache-misses is tightly related to the way in which BCP is implemented [ZM04] and, therefore, with the way in which clauses and watches are programmed. Since `plingeling` keeps a separate

Threads	# Problems solved	Total time
1	113	101399
2	121	95745
3	119	93854
4	122	90412
5	124	87953
6	124	89506
7	127	87416
8	124	88434
9	124	88931
10	125	89003
4 in 4 CPUs	126	88092
10 in 4 CPUs ⁷	129	85224
40 in 4 CPUs	123	92387

Table 1: Scalability

clause database for each thread, it is possible that sharing data could improve cache performance, because we would have a smaller amount of total data to propagate with. Based on other parallel SAT-solvers that share their clause database, mainly `SArTagnan` and `MiraXT`, we decided to implement `AzuDICI`, a basic CDCL SAT-solver with the purpose of improving the BCP performance in portfolio-based pSAT solvers. Three versions of `AzuDICI` were implemented, one in which each thread keeps a separate database clause; another in which, as in `MiraXT`, shares all clauses physically; and a hybrid one that only shares the binary implication lists.

4.1.1 The general structure of `AzuDICI`

`AzuDICI`⁸ is a standard CDCL solver based on `plingeling`, `barcelologic` and `miraXT`. In particular, `AzuDICI` implements binary implication lists for the propagation with binary clauses, and the two-watched[ZM04] for BCP with clauses of more than two literals. `AzuDICI` also implements the 1-UIP algorithm[MSS99, MMZ⁺01] for conflict analysis, the lemma simplification algorithm used in `PicoSAT`, Luby restarts [LSZ93], a policy for lemma cleaning that keeps only binary and ternary lemmas, and more than four-literal lemmas that have participated in a conflict since the last cleanup. Finally, `AzuDICI` also incorporates the EVSIDS heuristic for branching literal decisions [ES04b].

4.1.2 Shared-none

This version works as `plingeling`, it does not share any clause physically. Each thread keeps its own independent database of clauses and propagates with it.

⁸You can find the latest implementation of `AzuDICI` at <https://github.com/leoferrres/azu>.

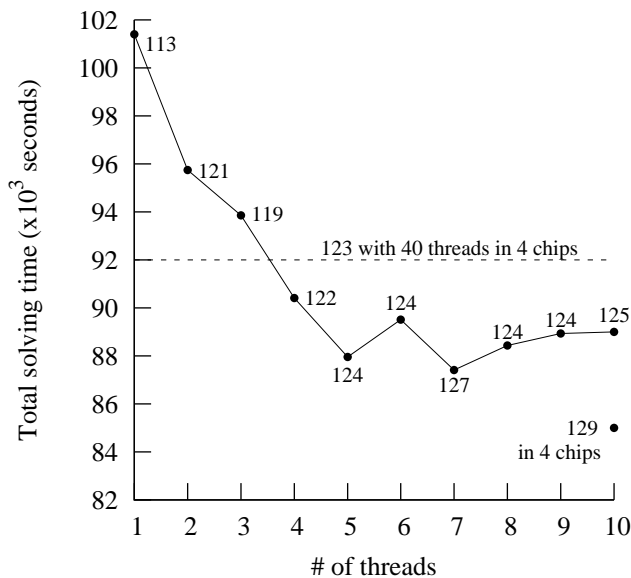

Figure 4: Total solving time per number of threads.

Note that the fact that we are not sharing data physically does not mean threads cannot share information. They could, for example, share unit clauses through message passing between threads, just as `plingeling` does. We are interested in measuring the impact of sharing data physically on cache performance, and not the benefits for the search of sharing information itself.

4.1.3 Shared-bins

The Shared-bins version shares the binary implication lists. All threads have access to the same physical data, they all can modify and read this structure. Figure 5 is a schematization of our binary implication lists structure. We have an array of *binary lists*, one for each literal. A binary list is basically two pointers, one to a first *binary node* and another to the last binary node associated with that list. A binary node is an array of literals that also has a pointer to another binary node. The amount of literals a binary node can hold will depend on the size of the cache line we are working with; it will have as many literals as a cache line can hold. The literals implied by the literal associated to a binary list will be the ones in the binary node referenced by that binary list pointer and the subsequently referenced binary nodes.

When a thread wants to add the clause $\{l_i, l_j\}$, it must look for the binary list associated with $\neg l_i$ and go to the last node linked to that binary list. If there is enough space in that node to add another literal, then it adds l_j . If the node is full, then it must create a new node with the l_j literal, insert it at the end of the linked list of nodes and update the binary list last node pointer. It

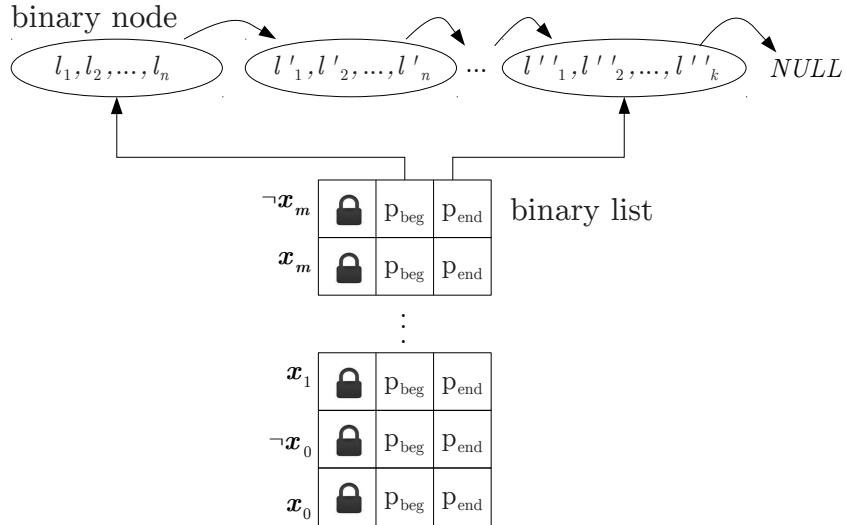

Figure 5: Binary clause database

does the same for the binary list of $\neg l_j$.

To ensure consistency of data when multiple threads are inserting, each binary list has a lock. If a thread is inserting a new implicated literal, it first locks the binary list where it is inserting and then proceeds to insert. If by chance another thread wants to insert in the same binary list, it must wait till the lock is freed. Since adding binary clauses is not frequent, and the event that it would happen in the same binary list is even less frequent, the contention that these locks generate is unnoticeable in our experimental results.

4.1.4 Shared-all

In the shared-bins solver we had no need to modify the usual two watched literal scheme used in propagation. This is not the case for this version that shares n-ary clauses physically. For the implementation of the two watched literal scheme, it is necessary to keep track of which literals are being watched in each n-clause. For instance, in a sequential solver, a typical implementation would consist in watching the first two literals of the clause. In portfolio-based pSAT solvers that physically share de clauses, since several threads could be accessing the same clause, changes to the clause are not feasible. It is impossible since threads of the portfolio may be watching different literals of a same clause. Instead, we have used a similar approach to that used in *MiraXT*, where each thread keeps track of the literals being watched in each clause. Figure 6 is a schematization of how each thread worker relates with the n-ary clause database. Each SAT solver thread has a vector of pointers to thread clauses called *watches*, and each literal present in the SAT problem has a position associated with this watches vector. A thread clause has two watched literals (WL0 and WL1), two pointers

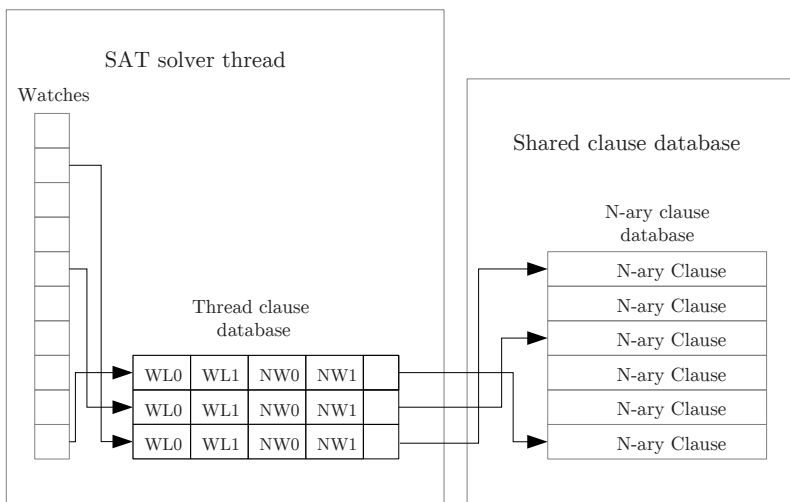

Figure 6: The thread clause database and n-ary clause database

to another thread clause (NW0 and NW1) and a pointer to an actual n-ary clause in the n-ary clause database. W0 and W1 keep track of the literals being watched by the thread for a given n-ary clause. NW0 and NW1 point to the next thread clauses where WL0 and WL1 are also being watched. The n-clause also has a flag for each worker thread to identify which ones are using that clause for propagation.

To insert a new n-ary clause, we first make sure that the clause does not exist in the database. If it does not exist, we create the n-clause, set the current thread flag to true and add it to the database. On the other hand, if it does exist, we just toggle the corresponding thread flag of the n-clause to true. The “insert” procedure is locked so that two different threads can not insert at the same time. In our experiments we have not noticed any considerable overhead caused by this lock. In fact, after profiling, the time spent by the “insert” function is negligible in the total running time of the program, with or without locks.

To find out whether sharing the clause database was beneficial to the same-chip portfolio-based solver, we ran **AzuDICI** in three different versions (sharing all the clauses, sharing none of the clauses and sharing only binary clauses) on eight problems using one to six threads. Each run was repeated five times to mitigate potential system noise.

In the following subsections we present the results of two experiments measuring cache misses. In section 4.2 we ran the three different versions of **AzuDICI** where each thread executed the same search, which resembles the experiments done using modified **plingeling**(see section 3.1). In section 4.3, the three versions of **AzuDICI** were used to test the canonical work of SAT solvers, where each thread executed a different search.

Dataset	T2	T3	T4	T5	T6
manol-pipe-c10b	1.16	1.33	1.46	1.58	1.66
	1.14	1.28	1.40	1.50	1.58
	1.11	1.24	1.33	1.44	1.53
manol-pipe-c6bid_j	1.17	1.32	1.43	1.54	1.61
	1.15	1.29	1.39	1.48	1.55
	1.12	1.23	1.33	1.41	1.53
manol-pipe-c6nidw_j	1.18	1.33	1.44	1.54	1.61
	1.16	1.30	1.39	1.48	1.55
	1.12	1.22	1.32	1.41	1.52
manol-pipe-c7idw	1.19	1.33	1.42	1.50	1.56
	1.15	1.27	1.36	1.41	1.48
	1.15	1.24	1.31	1.38	1.47
manol-pipe-cha05-113	1.14	1.28	1.41	1.53	1.61
	1.12	1.24	1.35	1.45	1.53
	1.11	1.22	1.29	1.38	1.47
anbul-dated-5-15-u	1.26	1.49	1.67	1.81	1.91
	1.24	1.45	1.60	1.73	1.81
	1.15	1.39	1.50	1.64	1.74
ibm-2002-31_lr3-k30	1.10	1.22	1.29	1.37	1.42
	1.10	1.21	1.28	1.35	1.39
	1.09	1.16	1.23	1.30	1.34
post-c32s-gcdm16-22	1.09	1.17	1.23	1.30	1.33
	1.08	1.17	1.22	1.28	1.30
	1.06	1.15	1.20	1.26	1.29

Table 2: Performance decay in percentage over the T1 running time for AzuDICI version and number of threads (T). The first row of each dataset corresponds to Shared-None version, second row to Shared-Bin and third row to Shared-All.

4.2 Same search experiments

For this experiment, AzuDICI was modified to carry out the *same* search in each thread (i.e., there is no lemma sharing among threads). For each AzuDICI version, we measured the time needed to solve each benchmark, and the percentage of LLC misses. The results for this are shown in Table 2 and below.

Notice that the datasets we chose for this experiment were influenced by the early state of development of AzuDICI. Our solver is not optimized, and has been implemented for the purposes of experimentation. Thus, the datasets are generally “easier” so that AzuDICI can solve them. Contrariwise, we do not use the benchmarks we used for AzuDICI for `plingeling`, because these are solved so fast that scalability cannot be reliably measured. In other words, we have divided the whole dataset of problems into “easy” and “hard” problems. We have operationalized “easy” problems as those that AzuDICI can solve in the span of five to fifteen minutes, while `plingeling` takes less than one minute. “Hard” problems, in turn, are those that `plingeling` takes between five and fifteen minutes to solve. We use hard problems in AzuDICI for different search experiments with a timeout of 15 minutes and we don’t use easy problems in `plingeling`, since, for the latter, results would be tainted by system noise. Besides, given the nature of CDCL solvers, the size of the clause database will be increasing with execution time, and this size increase is where cache contention manifests itself more evidently.

Table 2 and Figure 7 show performance decay over the one thread (T1=1)

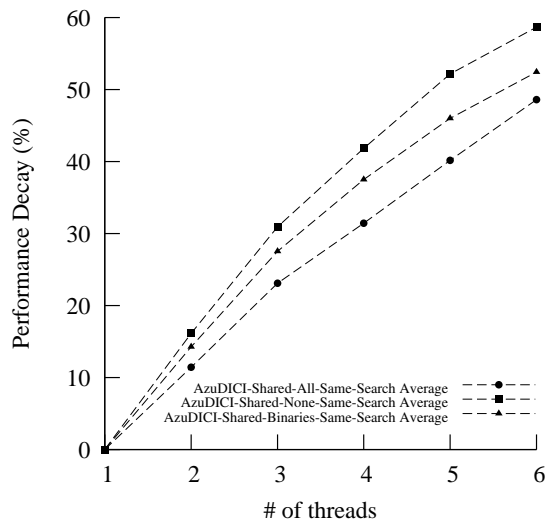

Figure 7: Average running time for AZUDICI version and number of threads

setting. Even if performance is worse as we add more threads, shared-all will perform consistently better than shared-binary, which will in turn perform better (perhaps less noticeably) than shared-none. This is due to the different levels of non-replication and physical sharing of the database clause.

On aggregate, comparing the performance of AzuDICI as shown in Figure 7 and 8, it is evident that the solver performs best in the shared-all setting, followed by the shared-binary and finally by the shared-none setting in both running time and cache misses. Thus, our implementation shows that physically sharing the clause database is beneficial to avoid cache contention in the rather artificial case of same search.

4.3 Different search experiments

Although the previous experiments point out that physically sharing the clause database between threads may lead to improve the cache performance of the solvers, the results are not generalizable to a full-featured SAT solver. It may be the case that while threads are carrying out the same search, it is more likely that they will access the same data. Whereas different search threads are clearly not necessarily accessing the same data at the same time.

To find out how real portfolio-based SAT solvers implementing different levels of physical clause sharing behave, we ran AzuDICI in the same three different versions as before (sharing-all, share-none and share-bin) on the eight problems introduced in Section 3.1 using one to six threads and a 5-minute timeout (we therefore did not include a running time table and graph). The timeout characteristics was due to the fact that different searches among threads may result in different (potentially better) strategies, affecting execution time

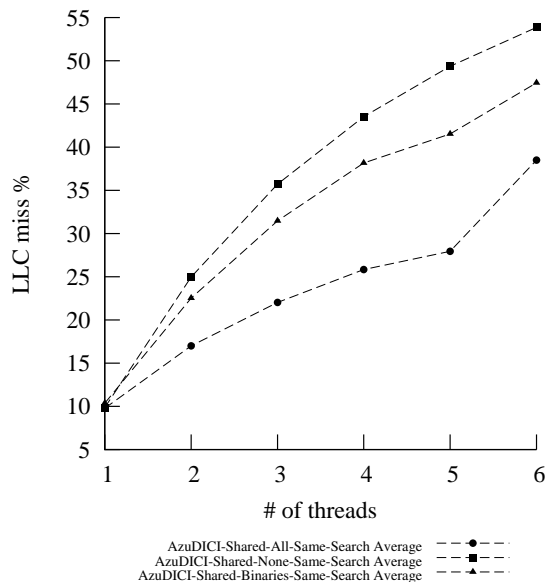

Figure 8: Average cache misses for AZUDICI version and number of threads

and rendering search behavior effectively incomparable. Each run was repeated five times to clean up potential system noise.

There are a few things to notice about Table 4. First, there are overall fewer cache misses in the shared-all setting, with the exception of file `grid-...-3.035-NOTKNOWN`. This file is particular in that there is almost no cache contention. This may be because the percentage of binary clauses (98%) accounts for practically all clauses. Due to the special data structures used for propagation with binary clauses, the propagation computation does not incur in noticeable cache penalties. It is also interesting to notice that the difference between shared-binary and shared-all when compared to shared-none (see Figure 9) is not as large as in the previous section (see Figure 8, and Table 3 for details).

From these data, we may conclude that physically sharing the whole clause database does not seem to significantly improve the cache performance of the portfolio-based pSAT solvers.

5 Conclusions and Future Work

We showed that the impact of threads accessing the shared caches is very significant and it negatively impacts the scalability of portfolio-based pSAT solvers. We believe this is an important topic for further advancing knowledge on parallel SAT solvers.

When it comes to whether physically sharing the clause database among threads is advantageous, we may conclude that it is not yet clear whether sharing

Dataset	T1	T2	T3	T4	T5	T6
manol-pipe-c10b	2.6(2.4)	15.7(0.6)	27.2(0.1)	36.4(0.2)	43.2(0.1)	48.8(0.0)
	3.5(5.0)	13.5(2.9)	21.0(3.6)	27.5(2.9)	31.2(1.7)	38.6(0.8)
	3.4(4.8)	9.6(8.2)	15.4(5.1)	17.7(5.3)	21.2(4.4)	29.2(2.5)
manol-pipe-c6bid _i	11.8(0.3)	27.2(0.1)	37.5(0.1)	44.8(0.1)	50.3(0.0)	54.7(0.0)
	12.5(0.2)	24.0(2.6)	32.6(2.0)	38.6(1.2)	43.3(2.7)	49.0(0.5)
	12.1(0.4)	18.0(7.1)	21.1(0.1)	25.7(3.2)	28.3(1.0)	43.3(1.3)
manol-pipe-c6nidw _i	13.2(0.2)	29.0(0.1)	39.3(0.1)	46.5(0.0)	52.1(0.1)	56.3(0.0)
	14.0(0.6)	26.2(2.3)	35.4(1.4)	41.2(2.4)	44.1(0.6)	50.3(0.5)
	13.5(0.3)	19.5(6.4)	22.6(0.1)	26.4(0.1)	29.5(0.1)	43.7(1.8)
manol-pipe-c7idw	13.7(0.6)	30.1(0.1)	38.7(0.1)	44.6(0.1)	49.0(0.0)	52.6(0.1)
	14.8(0.4)	24.6(3.7)	30.8(3.3)	35.8(2.5)	34.4(1.6)	42.0(2.0)
	15.3(0.4)	22.4(6.2)	22.9(0.1)	25.2(0.1)	27.2(0.1)	36.4(4.5)
manol-pipe-cha05-113	1.8(2.3)	13.2(1.1)	23.2(0.6)	31.8(0.3)	38.6(0.1)	44.4(0.0)
	2.4(4.2)	10.6(1.4)	17.4(1.8)	23.7(1.0)	27.1(1.2)	34.6(0.5)
	2.5(6.0)	8.5(0.8)	13.0(8.2)	15.3(5.9)	16.8(2.4)	24.2(2.8)
anbul-dated-5-15-u	8.6(0.6)	28.4(0.2)	42.9(0.1)	52.3(0.1)	58.9(0.0)	63.2(0.0)
	8.9(0.6)	27.7(0.1)	41.1(0.3)	50.2(0.1)	55.8(0.2)	61.0(0.1)
	6.5(9.1)	15.0(9.1)	28.9(7.9)	33.9(3.8)	37.9(2.0)	49.2(1.7)
ibm-2002-31 _i 1r3-k30	13.2(1.2)	28.7(0.2)	39.9(0.0)	48.0(0.0)	53.7(0.1)	57.8(0.0)
	13.0(0.3)	28.2(0.2)	39.0(0.1)	47.1(0.0)	52.4(0.3)	56.3(0.2)
	11.8(2.5)	23.3(0.8)	25.1(4.1)	31.7(4.8)	31.9(3.1)	42.5(2.1)
post-c32s-gcdm16-22	13.8(0.7)	27.4(0.2)	37.1(0.0)	43.9(0.1)	49.0(0.1)	53.0(0.0)
	13.8(0.1)	25.4(2.7)	34.4(0.8)	41.2(0.3)	44.0(1.0)	47.6(0.9)
	13.2(0.3)	19.8(9.0)	27.3(3.2)	31.0(1.8)	30.7(3.6)	39.5(1.5)

Table 3: LLC misses (%) for AzuDICI version and number of threads (T). The first row of each dataset corresponds to Shared-None version, second row to Shared-Bin and third row to Shared-All . Numbers in parentheses are standard deviations in %.

the clause database in the way we have proposed has a significant effect on running time of the solver. On the one hand, it should be clear that physically sharing data (in general) should be beneficial for parallel programs (if for no other reason, just to save space). However, to implement solvers that physically share the clause database is non-trivial, and prone to increasing complexity and running time. Interestingly, the problems are not related, as is usual with these kinds of systems, to, for instance, synchronization among the threads, but rather stem from the BCP mechanism. This is so because each thread must keep track of its own watches (which, as far as is known, cannot be shared in a portfolio approach).

The relevance of cache efficient algorithms in CDCL SAT-solvers performance has been known since at least 1993, with Zhang and Malik’s paper [ZM04]. In this work we intend to update and measure such influence in portfolio-based parallel CDCL SAT-solvers. The design of AzuDICI shared-all version is quite similar to that of the (pa)MiraXT solver [SLB09]. To the best of our knowledge, the first portfolio-based pSAT solver that physically shares the clause database is SArTagnan [KK11]. An in-depth survey of parallel CDCL SAT-solvers can be found in [MML12].

As future work we also plan to continue the development of AzuDICI, incorporating in it further enhancements like formula preprocessing and variable elimination among others, so as to make it a competitive parallel SAT solver. Regarding the Cache performance, we also plan to implement our solver with

Dataset	T1	T2	T3	T4	T5	T6
aaai10-...-step17	3.0(5.2)	7.5(0.6)	14.0(0.3)	21.5(0.3)	27.3(0.2)	34.1(0.1)
	2.9(1.4)	6.4(3.8)	13.9(2.7)	17.8(3.0)	25.5(1.1)	31.2(1.5)
	2.8(0.9)	5.8(2.0)	12.3(1.8)	16.5(1.4)	22.6(0.2)	29.0(1.3)
E02F22	31.8(0.4)	44.0(0.1)	48.5(0.0)	53.8(0.0)	58.0(0.0)	62.6(0.1)
	26.8(0.2)	40.9(5.1)	47.5(3.4)	54.7(1.5)	58.9(2.3)	62.3(1.9)
	30.9(0.1)	40.2(2.7)	48.7(3.1)	52.8(1.9)	57.3(1.6)	60.4(2.2)
grid-...-3.035-NOTKNOWN	0.2(3.5)	0.5(1.4)	0.5(0.9)	0.7(2.1)	0.8(2.9)	1.0(7.0)
	0.2(8.5)	0.7(4.3)	0.9(1.4)	1.0(3.9)	1.1(3.4)	1.4(2.2)
	0.3(1.1)	0.3(1.4)	0.6(4.2)	0.9(4.4)	1.1(4.0)	1.4(7.7)
hwmcc10-...-k45-pdtvissoap1-tseitn	22.0(0.4)	33.6(0.1)	44.2(0.1)	50.6(0.1)	54.9(0.0)	59.5(0.0)
	25.3(0.6)	34.5(0.4)	42.1(0.5)	48.3(0.2)	53.3(0.1)	56.8(0.3)
	25.1(0.1)	34.1(0.6)	41.8(0.3)	48.3(0.3)	52.6(0.2)	56.0(0.3)
hwmcc10-...-k50-pdtpmsns2-tseitn	12.8(0.3)	27.0(0.0)	35.9(0.1)	44.8(0.0)	49.3(0.1)	54.0(0.0)
	14.0(0.6)	26.0(0.9)	35.8(0.7)	40.9(1.3)	46.7(0.2)	49.8(0.5)
	15.0(0.3)	26.8(1.3)	36.2(0.3)	41.9(0.1)	46.6(0.4)	50.6(0.3)
md5_48_3	12.1(0.5)	23.3(0.1)	31.9(0.2)	39.1(0.1)	43.6(0.1)	48.2(0.0)
	13.4(0.3)	23.0(2.8)	32.0(0.2)	37.0(0.2)	41.8(2.1)	46.1(0.1)
	14.3(0.2)	23.5(0.3)	32.2(0.3)	37.0(0.1)	41.8(0.2)	45.7(0.2)
q_query_3_L150_coli.sat	23.1(0.8)	39.0(0.2)	50.2(0.0)	58.2(0.1)	62.1(0.0)	66.0(0.0)
	35.8(0.1)	43.0(1.2)	52.8(1.5)	57.9(0.3)	62.3(0.8)	66.8(0.3)
	34.5(0.3)	36.6(2.8)	50.4(1.3)	56.0(0.5)	61.2(0.7)	63.6(0.5)
slp-synthesis-aes-top30	11.5(0.7)	20.4(0.2)	29.3(0.1)	36.8(0.1)	42.3(0.1)	47.7(0.1)
	12.2(0.2)	17.8(0.8)	26.2(0.5)	32.1(0.2)	37.8(0.4)	42.9(0.3)
	13.2(0.2)	18.3(0.2)	26.3(0.2)	31.7(0.4)	37.4(0.3)	42.1(0.2)
traffic_b_unsat	4.4(3.4)	17.4(0.7)	31.9(0.3)	44.3(0.1)	52.1(0.0)	59.8(0.0)
	4.3(1.8)	16.7(1.2)	31.4(0.2)	41.7(0.2)	51.4(0.1)	58.7(0.0)
	4.0(3.5)	14.6(0.3)	28.4(0.5)	37.5(0.4)	46.3(0.2)	53.8(0.1)
UCG-15-10p1	21.4(0.6)	31.8(0.1)	40.6(0.1)	43.6(0.1)	46.9(0.1)	49.8(0.1)
	20.7(0.7)	31.7(3.0)	40.9(2.4)	46.2(2.0)	53.5(0.8)	55.5(0.6)
	22.6(0.6)	34.8(1.8)	42.8(2.8)	49.6(2.1)	51.6(1.7)	55.2(0.5)

Table 4: LLC misses (%) for AzuDICI version and number of threads (T). The first row of each dataset corresponds to Shared-None version, second row to Shared-Bin and third row to Shared-All. Numbers in parenthesis are standard deviations in %.

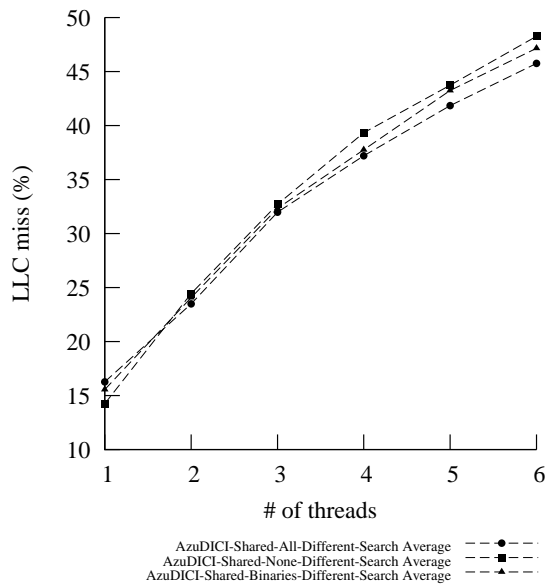

Figure 9: Average cache misses for AZUDICI version and number of threads

compact data structures so that more information can fit in the cache.

Acknowledgments

We would like to thank several people and institutions for their help in producing this paper, either in time, resources or both. First, we would like to thank the Barcelogic group for sharing the code of a past Barcelogic SAT-solver and for their support while writing AzuDICI. Likewise, we’d like to thank Armin Biere for opensourcing his `plingeling` code, and Enric Rodriguez-Carbonell, Technical University of Catalunya for (conscientiously!) proofreading an earlier draft of this paper. Finally, we would like to thank Paul Steinberg at Intel, and the staff at the Intel ManyCore Testing Lab, where we carried out the experiments. Roberto Asín acknowledges the partial support from Fondecyt through Project No. 11121220

References

- [AS09] Gilles Audemard and Laurent Simon. Predicting learnt clauses quality in modern sat solvers. In Craig Boutilier, editor, *IJCAI*, pages 399–404, 2009.
- [Bie08] Armin Biere. Picosat essentials. *JSAT*, 4(2-4):75–97, 2008.

- [Bie10] Armin Biere. Lingeling, Plingeling, PicoSAT and PrecoSAT at SAT Race 2010. Technical report, Institute for Formal Models and Verification, Johannes Kepler University, 2010.
- [Bie11] Armin Biere. Lingeling and friends at the SAT Competition 2011. Technical Report 11-1, FMV Reports Series, Institute for Formal Models and Verification, Johannes Kepler University, Linz, Austria, March 2011.
- [BS97] Roberto J. Jr. Bayardo and Robert C. Schrag. Using CSP look-back techniques to solve real-world SAT instances. In *Proceedings of the Fourteenth National Conference on Artificial Intelligence (AAAI'97)*, pages 203–208, Providence, Rhode Island, 1997.
- [DLL62] M. Davis, G. Logemann, and D. Loveland. A Machine Program for Theorem-Proving. *Communications of the ACM, CACM*, 5(7):394–397, 1962.
- [ES04a] N. Eén and N. Sörensson. An Extensible SAT-solver. In E. Giunchiglia and A. Tacchella, editors, *6th International Conference on Theory and Applications of Satisfiability Testing, SAT'03*, volume 2919 of *Lecture Notes in Computer Science*, pages 502–518. Springer, 2004.
- [ES04b] N. Eén and N. Sörensson. An Extensible SAT-solver. In E. Giunchiglia and A. Tacchella, editors, *6th International Conference on Theory and Applications of Satisfiability Testing, SAT'03*, volume 2919 of *Lecture Notes in Computer Science*, pages 502–518. Springer, 2004.
- [GN02] E. Goldberg and Y. Novikov. BerkMin: A fast and robust SAT-solver. In *Design, Automation, and Test in Europe (DATE '02)*, pages 142–149, 2002.
- [HJS09] Youssef Hamadi, Saïd Jabbour, and Lakhdar Sais. Manysat: a parallel sat solver. *JSAT*, 6(4):245–262, 2009.
- [JS97] Roberto J. Bayardo Jr. and Robert Schrag. Using csp look-back techniques to solve real-world sat instances. In *AAAI/IAAI*, pages 203–208, 1997.
- [KK11] Stephan Kottler and Michael Kaufmann. Sartagnan - a parallel portfolio sat solver with lockless physical clause sharing. In *Pragmatics of SAT*, 2011.
- [LSZ93] Michael Luby, Alistair Sinclair, and David Zuckerman. Optimal speedup of las vegas algorithms. *Inf. Process. Lett.*, 47(4):173–180, 1993.

- [MML12] Ruben Martins, Vasco M. Manquinho, and Inês Lynce. Parallel search for maximum satisfiability. *AI Commun.*, 25(2):75–95, 2012.
- [MMZ⁺01] M. W. Moskewicz, C. F. Madigan, Y. Zhao, L. Zhang, and S. Malik. Chaff: Engineering an Efficient SAT Solver. In *38th Design Automation Conference, DAC'01*, pages 530–535. ACM Press, 2001.
- [MSS99] Joao Marques-Silva and Karem A. Sakallah. Grasp: A search algorithm for propositional satisfiability. *IEEE Trans. Comput.*, 48(5):506–521, 1999.
- [NOT06] R. Nieuwenhuis, A. Oliveras, and C. Tinelli. Solving SAT and SAT Modulo Theories: From an abstract Davis–Putnam–Logemann–Loveland procedure to DPLL(T). *Journal of the ACM, JACM*, 53(6):937–977, 2006.
- [PD07] Knot Pipatsrisawat and Adnan Darwiche. Rsat 2.0: Sat solver description. Technical Report D–153, Automated Reasoning Group, Computer Science Department, UCLA, 2007.
- [Rou11] Olivier Roussel. Description of pfolio. Technical report, CRIL, Centre de Recherche en Informatique de Lens, 2011.
- [SLB09] Tobias Schubert, Matthew D. T. Lewis, and Bernd Becker. Pamirax: Parallel sat solving with threads and message passing. *JSAT*, 6(4):203–222, 2009.
- [SNC09] Mate Soos, Karsten Nohl, and Claude Castelluccia. Extending sat solvers to cryptographic problems. In Oliver Kullmann, editor, *SAT*, volume 5584 of *Lecture Notes in Computer Science*, pages 244–257. Springer, 2009.
- [Sut05] Herb Sutter. The free lunch is over: A fundamental turn toward concurrency in software. *Dr. Dobbs Journal*, 30(3):202–210, 2005.
- [Tse68] G. S. Tseitin. On the Complexity of Derivation in the Propositional Calculus. *Zapiski nauchnykh seminarov LOMI*, 8:234–259, 1968.
- [ZBH96] Hantao Zhang, Maria Paola Bonacina, and Jieh Hsiang. Psato: a distributed propositional prover and its application to quasigroup problems. *J. Symb. Comput.*, 21(4):543–560, 1996.
- [ZM04] L. Zhang and S. Malik. Cache Performance of SAT Solvers: A Case Study for Efficient Implementation of Algorithms. In E. Giunchiglia and A. Tacchella, editors, *6th International Conference on Theory and Applications of Satisfiability Testing, SAT'03*, volume 2919 of *Lecture Notes in Computer Science*, pages 287–298. Springer, 2004.

- [ZMMM01] L. Zhang, C. F. Madigan, M. W. Moskewicz, and S. Malik. Efficient conflict driven learning in a Boolean satisfiability solver. In *Int. Conf. on Computer-Aided Design (ICCAD'01)*, pages 279–285, 2001.
- [ZS96] H. Zhang and M. E. Stickel. An efficient algorithm for unit propagation. In *Proceedings of the Fourth International Symposium on Artificial Intelligence and Mathematics (AI-MATH'96)*, Fort Lauderdale (Florida USA), 1996.