

*Article*

# Topological Symmetry Groups of Small Complete Graphs

**Dwayne Chambers and Erica Flapan**

Pomona College, Claremont, CA 91711, USA

\* Author to whom correspondence should be addressed; eflapan@pomona.edu

*Version November 8, 2017 submitted to Symmetry. Typeset by L<sup>A</sup>T<sub>E</sub>X using class file mdpi.cls*

---

**Abstract:** Topological symmetry groups were originally introduced to study the symmetries of non-rigid molecules, but have since been used to study the symmetries of any graph embedded in  $\mathbb{R}^3$ . In this paper, we determine for each complete graph  $K_n$  with  $n \leq 6$ , what groups can occur as topological symmetry groups or orientation preserving topological symmetry groups of some embedding of the graph in  $\mathbb{R}^3$ .

**Keywords:** topological symmetry groups, molecular symmetries, complete graphs, spatial graphs

**Classification:** MSC 57M15, 57M25, 05C10, 92E10

---

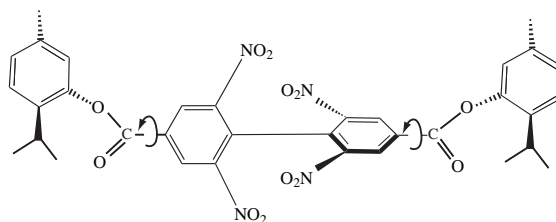
## 1. Introduction

Molecular symmetries are important in many areas of chemistry. Symmetry is used in interpreting results in crystallography, spectroscopy, and quantum chemistry, as well as in analyzing the electron structure of a molecule. Symmetry is also used in designing new pharmaceutical products. But what is meant by “symmetry” depends on the rigidity of the molecule in question.

For small molecules which are likely to be rigid, the group of rotations, reflections, and combinations of rotations and reflections, is an effective way of representing molecular symmetries. This group is known as the *point group*, of the molecule because it fixes a point of  $\mathbb{R}^3$ . However, some molecules can rotate around particular bonds, and large molecules can even be quite flexible. DNA demonstrates how flexible a long molecule can be. Even relatively small non-rigid molecules may have symmetries which are not included in the point group and can even be achiral as a result of their ability to rotate around particular bonds. For example, the left and right sides of the biphenyl derivative illustrated in Figure 1 rotate simultaneously, independent of the central part of the molecule. Because of these rotating

pieces, this molecule is achiral though it cannot be rigidly superimposed on its mirror form. A detailed discussion of the achirality of this molecule can be found in [3].

**Figure 1.** The sides of this molecule rotate as indicated.



In general, the amount of rigidity of a given molecule depends on its chemistry not just its geometry. Thus a purely mathematical definition of molecular symmetries that accurately reflects the behavior of all molecules is impossible. However, for non-rigid molecules, a topological approach to classifying symmetries can add important information beyond what is obtained from the point group. The definition of the topological symmetry group was first introduced by Jon Simon in 1987 in order to classify the symmetries of such molecules [17]. More recently, topological symmetry groups have been used to study the symmetries of arbitrary graphs embedded in 3-dimensional space, whether or not such graphs represent molecules. In fact, the study of symmetries of embedded graphs can be seen as a natural extension of the study of symmetries of knots which has a long history.

Though it may seem strange from the point of view of a chemist, the study of symmetries of embedded graphs as well as knots is more convenient to carry out in the 3-dimensional sphere  $S^3 = \mathbb{R}^3 \cup \{\infty\}$  rather than in Euclidean 3-space,  $\mathbb{R}^3$ . In particular, in  $\mathbb{R}^3$  every rigid motion is a rotation, reflection, translation, or a combination of these operations. Whereas, in  $S^3$  glide rotations provide an additional type of rigid motion. While a topological approach to the study of symmetries does not require us to focus on rigid motions, for the purpose of illustration it is preferable to display rigid motions rather than isotopies whenever possible. Thus throughout the paper we work in  $S^3$  rather than in  $\mathbb{R}^3$ .

**Definition 1.** The topological symmetry group of a graph  $\Gamma$  embedded in  $S^3$  is the subgroup of the automorphism group of the graph,  $\text{Aut}(\Gamma)$ , induced by homeomorphisms of the pair  $(S^3, \Gamma)$ . The orientation preserving topological symmetry group,  $\text{TSG}_+(\Gamma)$ , is the subgroup of  $\text{Aut}(\Gamma)$  induced by orientation preserving homeomorphisms of  $(S^3, \Gamma)$ .

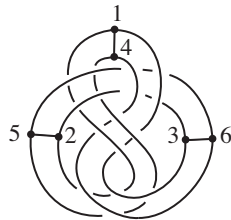
It should be noted that for any homeomorphism  $h$  of  $(S^3, \Gamma)$ , there is a homeomorphism  $g$  of  $(S^3, \Gamma)$  which fixes a point  $p$  not on  $\Gamma$  such that  $g$  and  $h$  induce the same automorphism on  $\Gamma$ . By choosing  $p$  to be the point at  $\infty$ , we can restrict  $g$  to a homeomorphism of  $(\mathbb{R}^3, \Gamma)$ . On the other hand if we start with an embedded graph  $\Gamma$  in  $\mathbb{R}^3$  and a homeomorphism  $g$  of  $(\mathbb{R}^3, \Gamma)$ , we can consider  $\Gamma$  to be embedded in  $S^3 = \mathbb{R}^3 \cup \{\infty\}$  and extend  $g$  to a homeomorphism of  $S^3$  simply by fixing the point at  $\infty$ . It follows that the topological symmetry group of  $\Gamma$  in  $S^3$  is the same as the topological symmetry group of  $\Gamma$  in  $\mathbb{R}^3$ . Thus we lose no information by working with graphs in  $S^3$  rather than graphs in  $\mathbb{R}^3$ .

It was shown in [9] that the set of orientation preserving topological symmetry groups of 3-connected graphs embedded in  $S^3$  is the same up to isomorphism as the set of finite subgroups of the group of orientation preserving diffeomorphisms of  $S^3$ ,  $\text{Diff}_+(S^3)$ . However, even for a 3-connected embedded

54 graph  $\Gamma$ , the automorphisms in  $\text{TSG}(\Gamma)$  are not necessarily induced by finite order homeomorphisms of  
 55  $(S^3, \Gamma)$ .

56 For example, consider the embedded 3-connected graph  $\Gamma$  illustrated in Figure 2. The automorphism  
 57  $(153426)$  is induced by a homeomorphism that slithers the graph along itself while interchanging the  
 58 inner and outer knots in the graph. On the other hand, the automorphism  $(153426)$  cannot be induced  
 59 by a finite order homeomorphism of  $S^3$  because there is no order three homeomorphism of  $S^3$  taking  
 60 a figure eight knot to itself [13,19] and the embedded graph in Figure 2 cannot be pointwise fixed by a  
 61 finite order homeomorphism of  $S^3$  [18].

**Figure 2.** The topological symmetry group of this embedded graph is not induced by a finite group of homeomorphisms of  $S^3$ .



62 On the other hand, Flapan proved the following theorem which we will make use of later in the paper.

63 **Finite Order Theorem.** [4] *Let  $\varphi$  be a non-trivial automorphism of a 3-connected graph  $\gamma$  which is*  
 64 *induced by a homeomorphism  $h$  of  $(S^3, \Gamma)$  for some embedding  $\Gamma$  of  $\gamma$  in  $S^3$ . Then for some embedding*  
 65  *$\Gamma'$  of  $\gamma$  in  $S^3$ , the automorphism  $\varphi$  is induced by a finite order homeomorphism,  $f$  of  $(S^3, \Gamma')$ , and  $f$  is*  
 66 *orientation reversing if and only if  $h$  is orientation reversing.*

67 In the definition of the topological symmetry group, we start with a particular embedding  $\Gamma$  of a  
 68 graph  $\gamma$  in  $S^3$  and then determine the subgroup of the automorphism group of  $\gamma$  which is induced  
 69 by homeomorphisms of  $(S^3, \Gamma)$ . However, sometimes it is more convenient to consider all possible  
 70 subgroups of the automorphism group of an abstract graph, and ask which of these subgroups can be the  
 71 topological symmetry group or orientation preserving topological symmetry group of some embedding  
 72 of the graph in  $S^3$ . The following definition gives us the terminology to talk about topological symmetry  
 73 groups from this point of view.

74 **Definition 2.** *An automorphism  $f$  of an abstract graph,  $\gamma$ , is said to be **realizable** if there exists an*  
 75 *embedding  $\Gamma$  of  $\gamma$  in  $S^3$  such that  $f$  is induced by a homeomorphism of  $(S^3, \Gamma)$ . A group  $G$  is said to*  
 76 *be **realizable for**  $\gamma$  if there exists an embedding  $\Gamma$  of  $\gamma$  in  $S^3$  such that  $\text{TSG}(\Gamma) \cong G$ . If there exists an*  
 77 *embedding  $\Gamma$  such that  $\text{TSG}_+(\Gamma) \cong G$ , then we say  $G$  is **positively realizable for**  $\gamma$ .*

78 It is natural to ask whether every finite group is realizable. In fact, it was shown in [9] that the  
 79 alternating group  $A_m$  is realizable for some graph if and only if  $m \leq 5$ . Furthermore, in [11] it was  
 80 shown that for every closed, connected, orientable, irreducible 3-manifold  $M$ , there exists an alternating  
 81 group  $A_m$  which is not isomorphic to the topological symmetry group of any graph embedded in  $M$ .

## 82 2. Topological symmetry groups of complete graphs

83 For the special class of complete graphs  $K_n$  embedded in  $S^3$ , Flapan, Naimi, and Tamvakis obtained  
84 the following result.

85 **Complete Graph Theorem.** [10] *A finite group  $H$  is isomorphic to  $\text{TSG}_+(\Gamma)$  for some embedding  $\Gamma$   
86 of a complete graph in  $S^3$  if and only if  $H$  is a finite subgroup of  $\text{SO}(3)$  or a subgroup of  $D_m \times D_m$  for  
87 some odd  $m$ .*

88 However, this left open the question of what topological symmetry groups and orientation preserving  
89 topological symmetry groups are possible for embeddings of a particular complete graph  $K_n$  in  $S^3$ . For  
90 each  $n > 6$ , this question was answered for orientation preserving topological symmetry groups in the  
91 series of papers [2,6–8].

92 In the current paper, we determine both the topological symmetry groups and the orientation  
93 preserving topological symmetry groups for all embeddings of  $K_n$  in  $S^3$  with  $n \leq 6$ . Another way  
94 to state this is that we determine which groups are realizable and which groups are positively realizable  
95 for each  $K_n$  with  $n \leq 6$ . This is the first family of graphs for which both the realizable and the positively  
96 realizable groups have been determined.

97 For  $n \leq 3$ , this question is easy to answer. In particular, since  $K_1$  is a single vertex, the only  
98 realizable or positively realizable group is the trivial group. Since  $K_2$  is a single edge, the only realizable  
99 or positively realizable group is  $\mathbb{Z}_2$ .

100 For  $n = 3$ , we know that  $\text{Aut}(K_3) \cong S_3 \cong D_3$ , and hence every realizable or positively  
101 realizable group for  $K_3$  must be a subgroup of  $D_3$ . Note that for any embedding of  $K_3$  in  $S^3$ ,  
102 the graph can be “slithered” along itself to obtain an automorphism of order 3 which is induced  
103 by an orientation preserving homeomorphism. Thus the topological symmetry group and orientation  
104 preserving topological symmetry group of any embedding of  $K_3$  will contain an element of order 3. Thus  
105 neither the trivial group nor  $\mathbb{Z}_2$  is realizable or positively realizable for  $K_3$ . If  $\Gamma$  is a planar embedding  
106 of  $K_3$  in  $S^3$ , then  $\text{TSG}(\Gamma) = \text{TSG}_+(\Gamma) \cong D_3$ . Recall that the trefoil knot  $3_1$  is chiral while the knot  
107  $8_{17}$  is negative achiral and non-invertible. Thus if  $\Gamma$  is the knot  $8_{17}$ , then no orientation preserving  
108 homeomorphism of  $(S^3, \Gamma)$  inverts  $\Gamma$ , but there is an orientation reversing homeomorphism of  $(S^3, \Gamma)$   
109 which inverts  $\Gamma$ . Whereas, if  $\Gamma$  is the knot  $8_{17} \# 3_1$ , then there is no homeomorphism of  $(S^3, \Gamma)$  which  
110 inverts  $\Gamma$ . Table 1 summarizes our results for  $K_3$ .

**Table 1.** Realizable and positively realizable groups for  $K_3$

Embedding	$\text{TSG}(\Gamma)$	$\text{TSG}_+(\Gamma)$
Planar	$D_3$	$D_3$
$8_{17}$	$D_3$	$\mathbb{Z}_3$
$8_{17} \# 3_1$	$\mathbb{Z}_3$	$\mathbb{Z}_3$

111 Determining which groups are realizable and positively realizable for  $K_4$ ,  $K_5$ , and  $K_6$  is the main  
112 point of this paper. In each case, we will first determine the positively realizable groups and then use the  
113 fact that either  $\text{TSG}_+(\Gamma) = \text{TSG}(\Gamma)$  or  $\text{TSG}_+(\Gamma)$  is a normal subgroup of  $\text{TSG}(\Gamma)$  of index 2 to help  
114 us determine the realizable groups.

115 In addition to the Complete Graph Theorem given above, we will make use of the following results  
 116 in our analysis of positively realizable groups for  $K_n$  with  $n \geq 4$ .

117 **A<sub>4</sub> Theorem.** [6] A complete graph  $K_m$  with  $m \geq 4$  has an embedding  $\Gamma$  in  $S^3$  such that  $\text{TSG}_+(\Gamma) \cong$   
 118  $A_4$  if and only if  $m \equiv 0, 1, 4, 5, 8 \pmod{12}$ .

119 **A<sub>5</sub> Theorem.** [6] A complete graph  $K_m$  with  $m \geq 4$  has an embedding  $\Gamma$  in  $S^3$  such that  $\text{TSG}_+(\Gamma) \cong$   
 120  $A_5$  if and only if  $m \equiv 0, 1, 5, 20 \pmod{60}$ .

121 **S<sub>4</sub> Theorem.** [6] A complete graph  $K_m$  with  $m \geq 4$  has an embedding  $\Gamma$  in  $S^3$  such that  $\text{TSG}_+(\Gamma) \cong S_4$   
 122 if and only if  $m \equiv 0, 4, 8, 12, 20 \pmod{24}$ .

123 **Subgroup Theorem.** [7] Let  $\Gamma$  be an embedding of a 3-connected graph  $\gamma$  in  $S^3$  with an edge that is not  
 124 pointwise fixed by any non-trivial element of  $\text{TSG}_+(\Gamma)$ . Then every subgroup of  $\text{TSG}_+(\Gamma)$  is positively  
 125 realizable for  $\gamma$ .

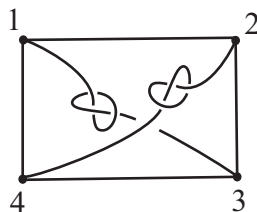
126 It was shown in [7] that adding a local knot to an edge of a 3-connected graph is well-defined and that  
 127 any homeomorphism of  $S^3$  taking the graph to itself must take an edge with a given knot to an edge with  
 128 the same knot. Furthermore, any orientation preserving homeomorphism of  $S^3$  taking the graph to itself  
 129 must take an edge with a given non-invertible knot to an edge with the same knot oriented in the same  
 130 way. Thus for  $n > 3$ , adding a distinct knot to each edge of an embedding of  $K_n$  in  $S^3$  will create an  
 131 embedding  $\Delta$  where  $\text{TSG}(\Delta)$  and  $\text{TSG}_+(\Delta)$  are both trivial. Hence we do not include the trivial group  
 132 in our list of realizable and positively realizable groups for  $K_n$  when  $n > 3$ .

133 Finally, observe that for  $n > 3$ , for a given embedding  $\Gamma$  of  $K_n$  we can add identical chiral knots  
 134 (whose mirror image do not occur in  $\Gamma$ ) to every edge of  $\Gamma$  to get an embedding  $\Gamma'$  such that  $\text{TSG}(\Gamma') =$   
 135  $\text{TSG}_+(\Gamma)$ . Thus every group which is positively realizable for  $K_n$  is also realizable for  $K_n$ . We will use  
 136 this observation in the rest of our analysis.

### 137 Topological Symmetry Groups of $K_4$

138 The following is a complete list of all the non-trivial subgroups of  $\text{Aut}(K_4) \cong S_4$  up to isomorphism:  
 139  $S_4, A_4, D_4, D_3, D_2, \mathbb{Z}_4, \mathbb{Z}_3, \mathbb{Z}_2$ .

**Figure 3.**  $\text{TSG}_+(\Gamma) \cong D_4$ .

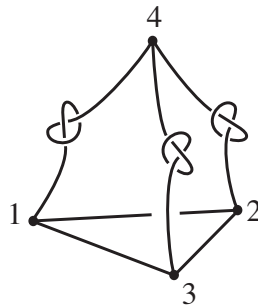


140 We will show that all of these groups are positively realizable, and hence all of the groups will also  
 141 be realizable. First consider the embedding  $\Gamma$  of  $K_4$  illustrated in Figure 3. The square  $\overline{1234}$  must go to

142 itself under any homeomorphism of  $(S^3, \Gamma)$ . Hence  $\text{TSG}_+(\Gamma)$  is a subgroup of  $D_4$ . In order to obtain the  
 143 automorphism  $(1234)$ , we rotate the square  $\overline{1234}$  clockwise by  $90^\circ$  and pull  $\overline{24}$  under  $\overline{13}$ . We can obtain  
 144 the transposition  $(13)$  by first rotating the figure by  $180^\circ$  about the axis which contains vertices 2 and 4  
 145 and then pulling  $\overline{13}$  under  $\overline{24}$ . Thus  $\text{TSG}_+(\Gamma) \cong D_4$ . Furthermore, since the edge  $\overline{12}$  is not pointwise  
 146 fixed by any non-trivial element of  $\text{TSG}_+(\Gamma)$ , by the Subgroup Theorem the groups  $\mathbb{Z}_4$ ,  $D_2$  and  $\mathbb{Z}_2$  are  
 147 each positively realizable for  $K_4$ .

148 Next, consider the embedding,  $\Gamma$  of  $K_4$  illustrated in Figure 4. All homeomorphisms of  $(S^3, \Gamma)$  fix  
 149 vertex 4. Hence  $\text{TSG}_+(\Gamma)$  is a subgroup of  $D_3$ . The automorphism  $(123)$  is induced by a rotation, and  
 150 the automorphism  $(12)$  is induced by turning the figure upside down and then pushing vertex 4 back  
 151 up through the centre of  $\overline{123}$ . Thus  $\text{TSG}_+(\Gamma) \cong D_3$ . Since the edge  $\overline{12}$  is not pointwise fixed by any  
 152 non-trivial element of  $\text{TSG}_+(\Gamma)$ , by the Subgroup Theorem, the group  $\mathbb{Z}_3$  is also positively realizable  
 153 for  $K_4$ .

**Figure 4.**  $\text{TSG}_+(\Gamma) \cong D_3$ .



154 Thus every subgroup of  $\text{Aut}(K_4)$  is positively realizable. Now by adding appropriate equivalent  
 155 chiral knots to each edge, all subgroups of  $\text{Aut}(K_4)$  are also realizable. We summarize our results for  
 156  $K_4$  in Table 2.

**Table 2.** Non-trivial realizable and positively realizable groups for  $K_4$

Subgroup	Realizable/Positively Realizable	Reason
$S_4$	Yes	By $S_4$ Theorem
$A_4$	Yes	By $A_4$ Theorem
$D_4$	Yes	By Figure 3
$D_3$	Yes	By Figure 4
$D_2$	Yes	By Subgroup Theorem
$\mathbb{Z}_4$	Yes	By Subgroup Theorem
$\mathbb{Z}_3$	Yes	By Subgroup Theorem
$\mathbb{Z}_2$	Yes	By Subgroup Theorem

### 157 3. Topological Symmetry Groups of $K_5$

158 The following is a complete list of all the non-trivial subgroups of  $\text{Aut}(K_5) \cong S_5$ :

159  $S_5, A_5, S_4, A_4, \mathbb{Z}_5 \rtimes \mathbb{Z}_4, D_6, D_5, D_4, D_3, D_2, \mathbb{Z}_6, \mathbb{Z}_5, \mathbb{Z}_4, \mathbb{Z}_3, \mathbb{Z}_2$  (see [15] and [20]).

160 The lemma below follows immediately from the Finite Order Theorem [4] (stated in the introduction)  
161 together with Smith Theory [18].

162 **Lemma 1.** *Let  $n > 3$  and let  $\varphi$  be a non-trivial automorphism of  $K_n$  which is induced by a*  
163 *homeomorphism  $h$  of  $(S^3, \Gamma)$  for some embedding  $\Gamma$  of  $K_n$  in  $S^3$ . If  $h$  is orientation reversing, then*  
164  *$\varphi$  fixes at most 4 vertices. If  $h$  is orientation preserving, then  $\varphi$  fixes at most 3 vertices, and if  $\varphi$  has even*  
165 *order, then  $\varphi$  fixes at most 2 vertices.*

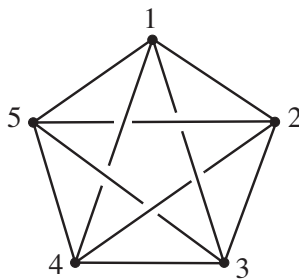
166 We now prove the following lemma.

167 **Lemma 2.** *Let  $n > 3$  and let  $\Gamma$  be an embedding of  $K_n$  in  $S^3$  such that  $\text{TSG}_+(\Gamma)$  contains an element  $\varphi$*   
168 *of even order  $m > 2$ . Then  $\varphi$  does not fix any vertex or interchange any pair of vertices.*

169 **Proof.** By the Finite Order Theorem,  $K_n$  can be re-embedded as  $\Gamma'$  so that  $\varphi$  is induced on  $\Gamma'$  by a finite  
170 order orientation preserving homeomorphism  $h$ . Suppose that  $\varphi$  fixes a vertex or interchanges a pair  
171 of vertices of  $\Gamma'$ . Then  $\text{fix}(h)$  is non-empty, and hence by Smith Theory,  $\text{fix}(h) \cong S^1$ . Let  $r = m/2$ .  
172 Then  $h^r$  induces an involution on the vertices of  $\Gamma'$ , and this involution can be written as a product  
173  $(a_1b_1) \dots (a_qb_q)$  of disjoint transpositions of vertices. Now for each  $i$ ,  $h^r$  fixes a point on the edge  $\overline{a_ib_i}$ .  
174 But  $\text{fix}(h^r)$  contains  $\text{fix}(h)$  and thus by Smith Theory  $\text{fix}(h^r) = \text{fix}(h)$ . Hence  $h$  fixes a point on each  
175 edge  $\overline{a_ib_i}$ . Thus  $h$  induces also  $(a_1b_1) \dots (a_qb_q)$  on the vertices of  $\Gamma'$ . But this contradicts the hypothesis  
176 that the order of  $\varphi$  is  $m > 2$ .  $\square$

177 By Lemma 2, there is no embedding of  $K_5$  in  $S^3$  such that  $\text{TSG}_+(\Gamma)$  contains an element of order 4  
178 or of order 6. It follows that  $\text{TSG}_+(\Gamma)$  cannot be  $D_6, \mathbb{Z}_6, D_4$  or  $\mathbb{Z}_4$ .

**Figure 5.**  $\text{TSG}_+(\Gamma) \cong D_5$ .

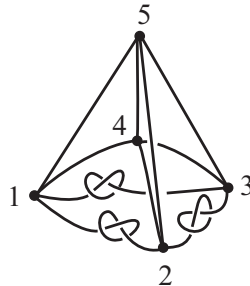


179 Consider the embedding  $\Gamma$  of  $K_5$  illustrated in Figure 5. The knotted cycle  $\overline{13524}$  must be setwise  
180 invariant under every homeomorphism of  $\Gamma$ . Thus  $\text{TSG}_+(\Gamma) \leq D_5$ . The automorphism  $(12345)$   
181 is induced by rotating  $\Gamma$ , and  $(25)(34)$  is induced by turning the graph over. Hence  $\text{TSG}_+(\Gamma) =$   
182  $\langle (12345), (25)(34) \rangle \cong D_5$ . Since the edge  $\overline{12}$  is not pointwise fixed by any non-trivial element of  
183  $\text{TSG}_+(\Gamma)$ , by the Subgroup Theorem the groups  $\mathbb{Z}_5$  and  $\mathbb{Z}_2$  are also positively realizable for  $K_5$ .

184 Next consider the embedding  $\Gamma$  of  $K_5$  illustrated in Figure 6. The triangle  $\overline{123}$  must go to itself  
185 under any homeomorphism. Also by Lemma 1, any orientation preserving homeomorphism which fixes  
186 vertices 1, 2, and 3 induces a trivial automorphism on  $K_5$ . Thus  $\text{TSG}_+(\Gamma) \leq D_3$ . The automorphism  
187  $(123)$  is induced by a rotation. Also the automorphism  $(45)(12)$  is induced by pulling vertex 4 down

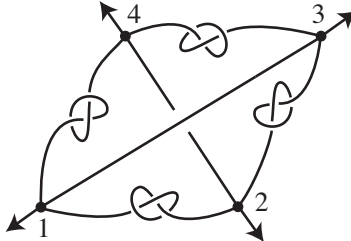
188 through the centre of triangle  $\overline{123}$  while pulling vertex 5 into the centre of the figure then rotating by  $180^\circ$   
 189 about the line through vertex 3 and the midpoint of the edge  $\overline{12}$ . Thus  $\text{TSG}_+(\Gamma) = \langle (123), (45)(12) \rangle \cong$   
 190  $D_3$ . Since the edge  $\overline{12}$  is not pointwise fixed by any non-trivial element of  $\text{TSG}_+(\Gamma)$ , by the Subgroup  
 191 Theorem, the group  $\mathbb{Z}_3$  is positively realizable for  $K_5$ .

**Figure 6.**  $\text{TSG}_+(\Gamma) \cong D_3$ .



192 Lastly, consider the embedding  $\Gamma$  of  $K_5$  illustrated in Figure 7 with vertex 5 at infinity. The square  
 193  $\overline{1234}$  must go to itself under any homeomorphism. Hence  $\text{TSG}_+(\Gamma) \leq D_4$ . The automorphism  $(13)(24)$   
 194 is induced by rotating the square by  $180^\circ$ . By turning over the figure we obtain  $(12)(34)$ . By Lemma 2,  
 195  $\text{TSG}_+(\Gamma)$  cannot contain an element of order 4. Thus  $\text{TSG}_+(\Gamma) = \langle (13)(24), (12)(34) \rangle \cong D_2$ .

**Figure 7.**  $\text{TSG}_+(\Gamma) \cong D_2$ .



196 We summarize our results on positive realizability for  $K_5$  in Table 3.

197 Again by adding appropriate equivalent chiral knots to each edge, all of the positively realizable  
 198 groups for  $K_5$  are also realizable. Thus we only need to determine realizability for the groups  $S_5$ ,  $S_4$ ,  
 199  $\mathbb{Z}_5 \times \mathbb{Z}_4$ ,  $D_6$ ,  $D_4$ ,  $\mathbb{Z}_6$ , and  $\mathbb{Z}_4$ .

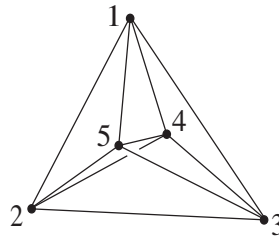
200 Let  $\Gamma$  be the embedding of  $K_5$  illustrated in Figure 8. Any transposition which fixes vertex 5 is  
 201 induced by a reflection through the plane containing the three vertices fixed by the transposition. To  
 202 see that any transposition involving vertex 5 can be achieved, consider the automorphism  $(15)$ . Pull  $\overline{51}$   
 203 through the triangle  $\overline{234}$  and then turn over the embedding so that vertex 5 is at the top, vertex 1 is in the  
 204 centre and vertices 3 and 4 are switched. Now reflect in the plane containing vertices 1, 5, and 2 in order  
 205 to switch vertices 3 and 4 back. All other transpositions involving vertex 5 can be induced by a similar  
 206 sequence of moves. Hence  $\text{TSG}(\Gamma) \cong S_5$ .

207 We create a new embedding  $\Gamma'$  from Figure 8 by adding the achiral figure eight knot,  $4_1$ , to all edges  
 208 containing vertex 5. Now every homeomorphism of  $(S^3, \Gamma')$  fixes vertex 5, yet all transpositions fixing  
 209 vertex 5 are still possible. Thus  $\text{TSG}(\Gamma') \cong S_4$ .

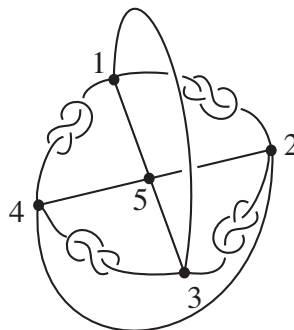


**Table 3.** Non-trivial positively realizable groups for  $K_5$ 

Subgroup	Positively Realizable	Reason
$A_5$	Yes	By $A_5$ Theorem
$S_4$	No	By $S_4$ Theorem
$A_4$	Yes	By $A_4$ Theorem
$D_6$	No	By Lemma 2
$D_5$	Yes	By Figure 5
$D_4$	No	By Lemma 2
$D_3$	Yes	By Figure 6
$D_2$	Yes	By Figure 7
$\mathbb{Z}_6$	No	By Lemma 2
$\mathbb{Z}_5$	Yes	By Subgroup Theorem
$\mathbb{Z}_4$	No	By Lemma 2
$\mathbb{Z}_3$	Yes	By Subgroup Theorem
$\mathbb{Z}_2$	Yes	By Subgroup Theorem

**Figure 8.**  $\text{TSG}(\Gamma) \cong S_5$ .

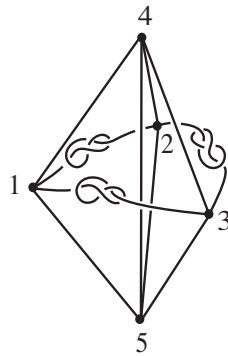
210 In order to prove  $D_4$  is realizable for  $K_5$  consider the embedding  $\Gamma$  illustrated in Figure 9. Every  
 211 homeomorphism of  $(S^3, \Gamma)$  takes  $\overline{1234}$  to itself, so  $\text{TSG}(\Gamma) \leq D_4$ . The automorphism  $(1234)$  is induced  
 212 by rotating the graph by  $90^\circ$  about a vertical line through vertex 5, then reflecting in the plane containing  
 213 the vertices 1, 2, 3, 4, and finally isotoping the knots into position. Furthermore, reflecting in the plane  
 214 containing  $\overline{153}$  or  $\overline{254}$  and then isotoping the knots into position yields the transposition  $(24)$  or  $(13)$   
 215 respectively. Hence  $\text{TSG}(\Gamma) \cong D_4$ .

**Figure 9.**  $\text{TSG}(\Gamma) \cong D_4$ .

216 We obtain a new embedding  $\Gamma'$  by replacing the invertible  $4_1$  knots in Figure 9 with the knot  $12_{427}$ ,  
 217 which is positive achiral but non-invertible [14]. Since  $12_{427}$  is neither negative achiral nor invertible, no  
 218 homeomorphism of  $(S^3, \Gamma')$  can invert  $\overline{1234}$ . Thus  $\text{TSG}(\Gamma') \cong \mathbb{Z}_4$ .

219 Next let  $\Gamma$  denote the embedding of  $K_5$  illustrated in Figure 10. Every homeomorphism of  $(S^3, \Gamma)$   
 220 takes  $\overline{123}$  to itself, so  $\text{TSG}(\Gamma) \leq D_6$ . The 3-cycle  $(123)$  is induced by a rotation. Each transposition  
 221 involving only vertices 1, 2, and 3 is induced by a reflection in the plane containing  $\overline{45}$  and the remaining  
 222 fixed vertex followed by an isotopy. The transposition  $(45)$  is induced by a reflection in the plane  
 223 containing vertices 1, 2 and 3 followed by an isotopy. Thus  $\text{TSG}(\Gamma) \cong D_6$ , generated by  $(123)$ ,  $(23)$ ,  
 224 and  $(45)$ .

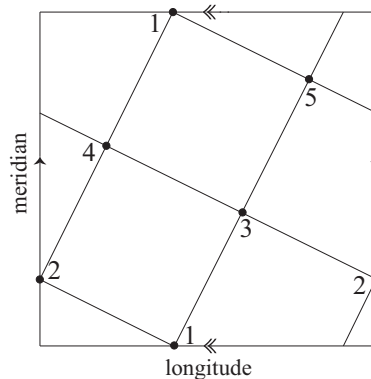
**Figure 10.**  $\text{TSG}(\Gamma) \cong D_6$ .



225 We obtain a new embedding  $\Gamma'$  by replacing the  $4_1$  knots in Figure 10 by  $12_{427}$  knots. Then the  
 226 triangle  $\overline{123}$  cannot be inverted. Thus  $\text{TSG}(\Gamma') \cong \mathbb{Z}_6$ , generated by  $(123)$  and  $(45)$ .

227 It is more difficult to show that  $\mathbb{Z}_5 \rtimes \mathbb{Z}_4$  is realizable for  $K_5$ , so we define our embedding in two steps.  
 228 First we create an embedding  $\Gamma$  of  $K_5$  on the surface of a torus  $T$  that is standardly embedded in  $S^3$ .  
 229 In Figure 11, we illustrate  $\Gamma$  on a flat torus. Let  $f$  denote a glide rotation of  $S^3$  which rotates the torus  
 230 longitudinally by  $4\pi/5$  and while rotating it meridinally by  $8\pi/5$ . Thus  $f$  takes  $\Gamma$  to itself inducing the  
 231 automorphism  $(12345)$ .

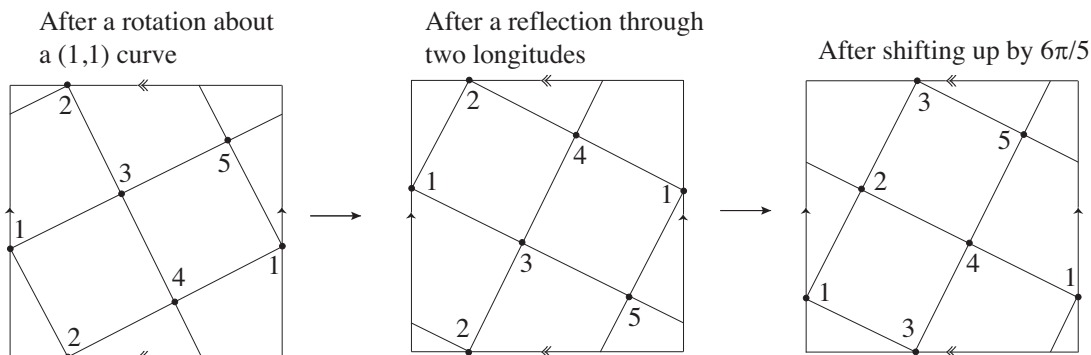
**Figure 11.** The embedding  $\Gamma$  of  $K_5$  in a torus.



232 Let  $g$  denote the homeomorphism obtained by rotating  $S^3$  about a  $(1, 1)$  curve on the torus  $T$ , followed  
 233 by a reflection through a sphere meeting  $T$  in two longitudes, and then a meridional rotation of  $T$  by

234  $6\pi/5$ . In Figure 12, we illustrate the step-by-step action of  $g$  on  $T$ , showing that  $g$  takes  $\Gamma$  to itself  
 235 inducing  $(2431)$ .

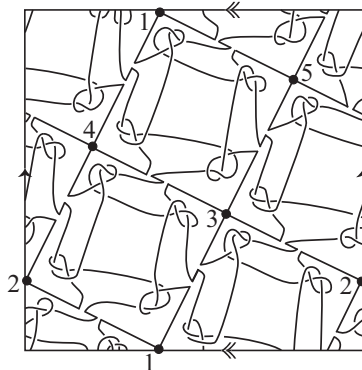
**Figure 12.** The action of  $g$  on  $\Gamma$



236 The homeomorphisms  $f$  and  $g$  induce the automorphisms  $\phi = (12345)$  and  $\psi = (2431)$  respectively.  
 237 Observe that  $\phi^5 = \psi^4 = 1$  and  $\psi\phi = \phi\psi^2$ . Thus  $\langle \phi, \psi \rangle \cong \mathbb{Z}_5 \rtimes \mathbb{Z}_4 \leq \text{TSG}(\Gamma) \leq S_5$ . Note however that  
 238 the embedding in Figure 11 is isotopic to the embedding of  $K_5$  in Figure 8. Thus  $\text{TSG}(\Gamma) \cong S_5$ .

239 In order to obtain the group  $\mathbb{Z}_5 \rtimes \mathbb{Z}_4$ , we now consider the embedding  $\Gamma'$  of  $K_5$  whose projection on a  
 240 torus is illustrated in Figure 13. Observe that the projection of  $\Gamma'$  in every square of the grid given by  $\Gamma$   
 241 on the torus is identical. Thus the homeomorphism  $f$  which took  $\Gamma$  to itself inducing the automorphism  
 242  $\phi = (12345)$  on  $\Gamma$  also takes  $\Gamma'$  to itself inducing  $\phi$  on  $\Gamma'$ .

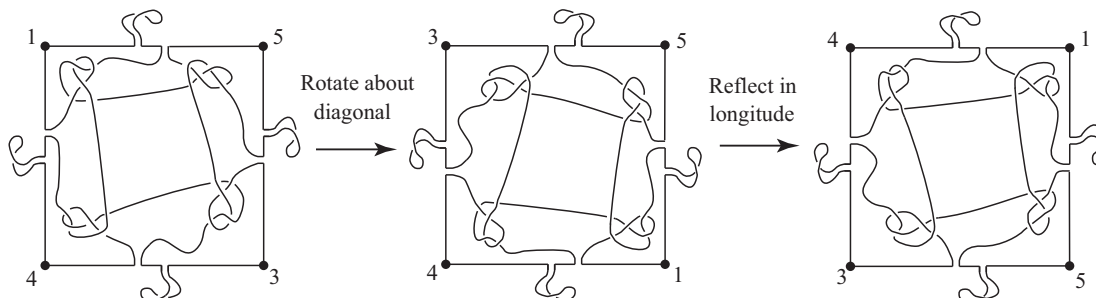
**Figure 13.** Projection of  $\Gamma'$  on the torus.



243 Recall that  $g$  was the homeomorphism of  $(S^3, \Gamma)$  obtained by rotating  $S^3$  about a  $(1, 1)$  curve on the  
 244 torus  $T$ , followed by a reflection through a sphere meeting  $T$  in two longitudes, and then a meridional  
 245 rotation of  $T$  by  $6\pi/5$ . In order to see what  $g$  does to  $\Gamma'$ , we focus on the square  $\overline{1534}$  of  $\Gamma'$ . Figure 14  
 246 illustrates a rotation of the square  $\overline{1534}$  about a diagonal, then a reflection of the square across a longitude.  
 247 The result of these two actions takes the projection of the knot  $\overline{1534}$  to an identical projection. Thus after  
 248 rotating the torus meridionally by  $6\pi/5$ , we see that  $g$  takes  $\Gamma'$  to itself inducing the automorphism  
 249  $\psi = (2431)$ . It now follows that  $\mathbb{Z}_5 \rtimes \mathbb{Z}_4 \leq \text{TSG}(\Gamma') \leq S_5$ .

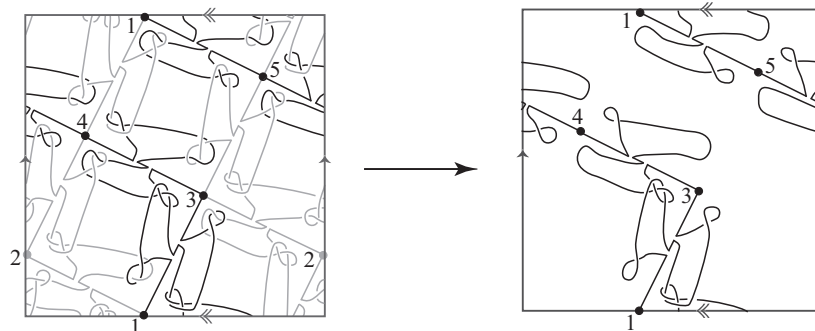
250 In order to prove that  $\text{TSG}(\Gamma') \cong \mathbb{Z}_5 \rtimes \mathbb{Z}_4$ , we need to show  $\text{TSG}(\Gamma') \not\cong S_5$ . We prove this by  
 251 showing that the automorphism (15) cannot be induced by a homeomorphism of  $(S^3, \Gamma')$ .

**Figure 14.** Effect of  $g$  on the square  $\overline{1534}$

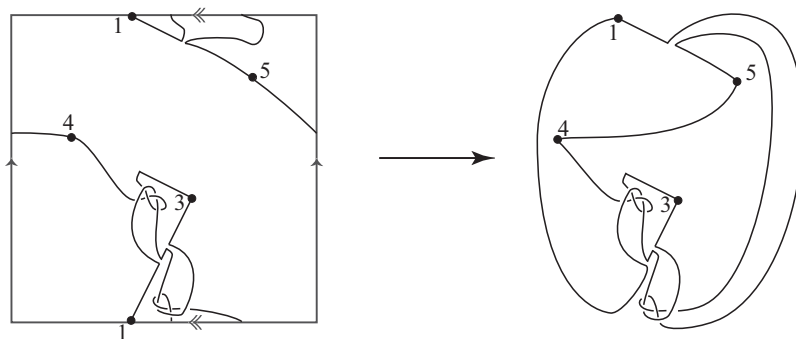


252 From Figure 14 we see that the square  $\overline{1534}$  is the knot  $4_1\#4_1\#4_1\#4_1$ . In order to see what would  
 253 happen to this knot if the transposition (15) were induced by a homeomorphism of  $(S^3, \Gamma')$ , we consider  
 254 the square  $\overline{5134}$ . In Figures 15 and 16 we isotop  $\overline{5134}$  to a projection with only 10 crossings. This means  
 255 that  $\overline{5134}$  cannot be the knot  $4_1\#4_1\#4_1\#4_1$ . It follows that the automorphism (15) cannot be induced by  
 256 a homeomorphism of  $(S^3, \Gamma')$ . Hence  $\text{TSG}(\Gamma') \not\cong S_5$ . However, the only subgroup of  $S_5$  that contains  
 257  $\mathbb{Z}_5 \rtimes \mathbb{Z}_4$  and is not  $S_5$  is the group  $\mathbb{Z}_5 \rtimes \mathbb{Z}_4$ . Thus in fact  $\text{TSG}(\Gamma') \cong \mathbb{Z}_5 \rtimes \mathbb{Z}_4$ .

**Figure 15.** The knot  $\overline{5134}$  projected on the torus.



**Figure 16.** A projection of  $\overline{5134}$  on the torus after an isotopy, followed by a projection of  $\overline{5134}$  on a plane.



258 Thus every subgroup of  $\text{Aut}(K_5)$  is realizable for  $K_5$ . Table 4 summarizes our results for  $\text{TSG}(K_5)$ .

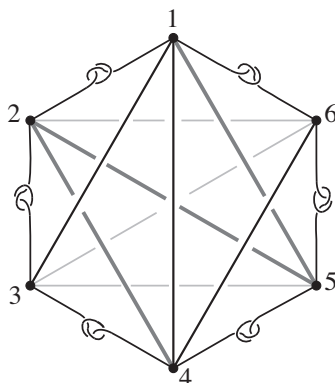
**Table 4.** Non-trivial realizable groups for  $K_5$ 

Subgroup	Realizable	Reason
$S_5$	Yes	By Figure 8
$A_5$	Yes	Positively realizable
$S_4$	Yes	By modifying Figure 8
$A_4$	Yes	Positively realizable
$D_6$	Yes	By Figure 10
$D_5$	Yes	Positively realizable
$D_4$	Yes	By Figure 9
$D_3$	Yes	Positively realizable
$D_2$	Yes	Positively realizable
$\mathbb{Z}_6$	Yes	By modifying Figure 10
$\mathbb{Z}_5 \times \mathbb{Z}_4$	Yes	By Figure 13
$\mathbb{Z}_5$	Yes	Positively realizable
$\mathbb{Z}_4$	Yes	By modifying Figure 9
$\mathbb{Z}_3$	Yes	Positively realizable
$\mathbb{Z}_2$	Yes	Positively realizable

#### 259 4. Topological Symmetry Groups of $K_6$

260 The following is a complete list of all the subgroups of  $\text{Aut}(K_6) \cong S_6$ :

261  $S_6, A_6, S_5, A_5, S_2[S_3]^1, S_4 \times \mathbb{Z}_2, A_4 \times \mathbb{Z}_2, S_4, A_4, \mathbb{Z}_5 \times \mathbb{Z}_4, D_3 \times D_3, (\mathbb{Z}_3 \times \mathbb{Z}_3) \times \mathbb{Z}_4, (\mathbb{Z}_3 \times \mathbb{Z}_3) \times \mathbb{Z}_2,$   
 262  $D_3 \times \mathbb{Z}_3, \mathbb{Z}_3 \times \mathbb{Z}_3, D_6, D_5, D_4, D_4 \times \mathbb{Z}_2, D_3, D_2, \mathbb{Z}_6, \mathbb{Z}_5, \mathbb{Z}_4, \mathbb{Z}_4 \times \mathbb{Z}_2, \mathbb{Z}_3, \mathbb{Z}_2, \mathbb{Z}_2 \times \mathbb{Z}_2 \times \mathbb{Z}_2$  (see [16]  
 263 and independently verified using the program GAP).

**Figure 17.**  $\text{TSG}_+(\Gamma) \cong D_6$ .

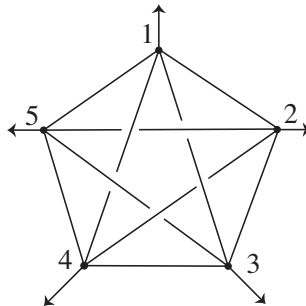
264 Consider the embedding  $\Gamma$  of  $K_6$  illustrated in Figure 17. There are three paths in  $\Gamma$  on different  
 265 levels that look like the letter “Z” which are highlighted in Figure 17. The top Z-path is  $\overline{3146}$ , the middle

<sup>1</sup>  $B[A]$  represents a wreath product of  $A$  by  $B$ .

266 Z-path is  $\overline{4251}$ , and the bottom Z-path is  $\overline{5362}$ . The knotted cycle  $\overline{123456}$  must be setwise invariant under  
 267 every homeomorphism of  $\Gamma$ , and hence  $\text{TSG}_+(\Gamma) \leq D_6$ . The automorphism  $(123456)$  is induced by a  
 268 glide rotation that cyclically permutes the Z-paths. Consider the homeomorphism obtained by rotating  
 269  $\Gamma$  by  $180^\circ$  about the line through vertices 2 and 5 and then pulling the edges  $\overline{13}$  and  $\overline{46}$  to the top level  
 270 while pushing the lower edges down. The result of this homeomorphism is that the top Z-path  $\overline{3146}$  goes  
 271 to the top Z-path  $\overline{1364}$ , the middle Z-path  $\overline{4251}$  goes to middle Z-path  $\overline{6253}$ , and the bottom Z-path  
 272  $\overline{5362}$  goes to the bottom Z-path  $\overline{5142}$ . Thus the homeomorphism leaves  $\Gamma$  setwise invariant inducing the  
 273 automorphism  $(13)(46)$ . It follows that  $\text{TSG}_+(\Gamma) = \langle (123456), (13)(46) \rangle \cong D_6$ . Finally, since the edge  
 274  $\overline{12}$  is not pointwise fixed by any non-trivial element of  $\text{TSG}_+(\Gamma)$ , by the Subgroup Theorem the groups  
 275  $\mathbb{Z}_6$ ,  $D_3$ ,  $\mathbb{Z}_3$ ,  $D_2$  and  $\mathbb{Z}_2$  are positively realizable for  $K_6$ .

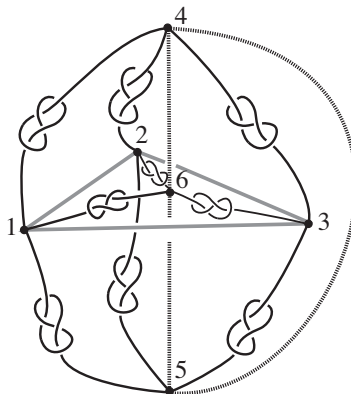
276 Consider the embedding,  $\Gamma$  of  $K_6$  illustrated in Figure 18 with vertex 6 at infinity. The automorphisms  
 277  $(13524)$  and  $(25)(34)$  are induced by rotations. Also since  $\overline{13524}$  is the only 5-cycle which is knotted,  
 278  $\overline{13524}$  is setwise invariant under every homeomorphism of  $(S^3, \Gamma)$ . Hence  $\text{TSG}_+(\Gamma) \cong D_5$ . Also  
 279 since  $\overline{15}$  is not pointwise fixed under any homeomorphism, by the Subgroup Theorem,  $\mathbb{Z}_5$  is positively  
 280 realizable for  $K_6$ .

**Figure 18.**  $\text{TSG}_+(\Gamma) \cong D_5$ .



281 Next consider the embedding,  $\Gamma$  of  $K_6$  illustrated in Figure 19. The automorphisms  $(123)(456)$  and  
 282  $(123)(465)$  are induced by glide rotations and  $(45)(12)$  is induced by turning the figure upside down.  
 283 Also if we consider the circles  $\overline{123}$  and  $\overline{465}$  as cores of complementary solid tori, then  $(14)(25)(36)$  is  
 284 induced by an orientation preserving homeomorphism that switches the two solid tori.

**Figure 19.**  $\text{TSG}_+(\Gamma) \cong D_3 \times D_3$ .



285 Observe that every homeomorphism of  $(S^3, \Gamma)$  takes the pair of triangles  $\overline{123} \cup \overline{456}$  to itself, since  
 286 this is the only pair of complementary triangles not containing knots. The automorphism group of the  
 287 union of two triangles is  $S_2[S_3]$  [12]. Thus  $\text{TSG}_+(\Gamma) \leq S_2[S_3]$ . Note that the transpositions (12)  
 288 and (45) are each induced by a reflection followed by an isotopy. Thus  $\text{TSG}(\Gamma) \cong S_2[S_3]$ , since  
 289 (123)(456), (123)(465), (12) and (14)(25)(36) generate  $S_2[S_3]$ . However, by the Complete Graph  
 290 Theorem,  $\text{TSG}_+(\Gamma) \not\cong S_2[S_3]$ . Thus  $\text{TSG}_+(\Gamma)$  must be an index 2 subgroup of  $S_2[S_3]$  containing  
 291  $f = (123)(456)$ ,  $g = (123)(465)$ ,  $\phi = (45)(12)$  and  $\psi = (14)(25)(36)$ . Observe that  $\phi\psi$  is the  
 292 involution (42)(51)(36), and  $f$  commutes with  $\psi$  and also  $f\phi\psi = \phi\psi f^{-1}$ , while  $g$  commutes with  
 293  $\phi\psi$  and  $g\psi = \psi g^{-1}$ . Thus  $S_2[S_3] \supseteq \text{TSG}_+(\Gamma) \geq \langle f, \phi\psi \rangle \times \langle g, \psi \rangle \cong D_3 \times D_3$ . It follows that  
 294  $\text{TSG}_+(\Gamma) \cong D_3 \times D_3$ .

295 The subgroup  $\langle f, g, \psi \rangle$  is isomorphic to  $D_3 \times \mathbb{Z}_3$  because  $\psi$  commutes with  $f$  and  $g\psi = \psi g^{-1}$ . We  
 296 add the non-invertible knot  $8_{17}$  to every edge of the triangles  $\overline{123}$  and  $\overline{456}$  to obtain an embedding  $\Gamma_1$ .  
 297 Now the automorphism  $\phi = (45)(12)$  cannot be induced by an orientation preserving homeomorphism  
 298 of  $(S^3, \Gamma_1)$ . However,  $f$ ,  $g$ , and  $\psi$  are still induced by orientation preserving homeomorphisms. Thus  
 299  $\text{TSG}_+(\Gamma_1) \cong D_3 \times \mathbb{Z}_3$  since  $D_3 \times \mathbb{Z}_3$  is a maximal subgroup of  $D_3 \times D_3$ .

300 Also  $\langle f, g, \phi \rangle$  is isomorphic to  $(\mathbb{Z}_3 \times \mathbb{Z}_3) \rtimes \mathbb{Z}_2$  because  $f\phi = \phi f^{-1}$  and  $g\phi = \phi g^{-1}$ . Again starting  
 301 with  $\Gamma$  in Figure 19, we place  $5_2$  knots on the edges of the triangle  $\overline{123}$  so that  $\psi$  is no longer induced.  
 302 Thus creating and embedding  $\Gamma_2$  with  $\text{TSG}_+(\Gamma_2) \cong (\mathbb{Z}_3 \times \mathbb{Z}_3) \rtimes \mathbb{Z}_2$  since  $(\mathbb{Z}_3 \times \mathbb{Z}_3) \rtimes \mathbb{Z}_2$  is a maximal  
 303 subgroup of  $D_3 \times D_3$ .

304 Finally  $\langle f, g \rangle$  is isomorphic to  $\mathbb{Z}_3 \times \mathbb{Z}_3$ . If we place equivalent non-invertible knots on each edge of  
 305 the triangle  $\overline{123}$  and a another set (distinct from the first set) of equivalent non-invertible knots on each  
 306 edge of  $\overline{456}$  we obtain an embedding  $\Gamma_3$  with  $\text{TSG}_+(\Gamma_3) \cong \mathbb{Z}_3 \times \mathbb{Z}_3$  since  $\mathbb{Z}_3 \times \mathbb{Z}_3$  is a maximal subgroup  
 307 of  $(\mathbb{Z}_3 \times \mathbb{Z}_3) \rtimes \mathbb{Z}_2$ .

308 We summarize our results on positively realizable for  $K_6$  in Table 5.

309 By adding appropriate equivalent chiral knots to each edge, every group which is positively realizable  
 310 for  $K_6$  is also realizable for  $K_6$ . Thus we only need to determine reliability for the groups  $S_6$ ,  $A_6$ ,  $S_5$ ,  
 311  $A_5$ ,  $S_4 \times \mathbb{Z}_2$ ,  $A_4 \times \mathbb{Z}_2$ ,  $S_4$ ,  $A_4$ ,  $\mathbb{Z}_5 \rtimes \mathbb{Z}_4$ ,  $(\mathbb{Z}_3 \times \mathbb{Z}_3) \rtimes \mathbb{Z}_4$ ,  $D_4$ ,  $D_4 \times \mathbb{Z}_2$ ,  $\mathbb{Z}_4$ ,  $\mathbb{Z}_4 \times \mathbb{Z}_2$ , and  $\mathbb{Z}_2 \times \mathbb{Z}_2 \times \mathbb{Z}_2$ .  
 312 Note that in Figure 19 we already determined that  $S_2[S_3]$  is realizable for  $K_6$ .

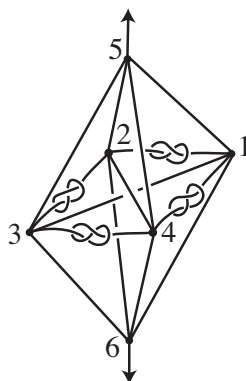
313 Let  $\Gamma_4$  be the embedding of  $K_6$  illustrated in Figure 19 with a left handed trefoil added to each edge  
 314 of  $\overline{123}$  and a right handed trefoil added to each edge of  $\overline{456}$ . The pair of triangles are setwise invariant  
 315 since no other edges contain trefoils. Both (123)(456) and (123)(465) are induced by homeomorphisms  
 316 of  $(\Gamma_4, S^3)$ . Also if we reflect in the plane containing vertices 4, 5, 6, and 1 then all the trefoils  
 317 switch from left-handed to right-handed and vice versa. If we then interchange the complementary  
 318 solid tori which have the triangles as cores followed by an isotopy, we obtain an orientation reversing  
 319 homeomorphism that induces the order 4 automorphism (14)(25)(36)(23) = (14)(2536). Now  
 320  $\langle (14)(2536), (123)(456), (123)(465) \rangle \cong (\mathbb{Z}_3 \times \mathbb{Z}_3) \rtimes \mathbb{Z}_4$ .

321 We see as follows that  $\text{TSG}(\Gamma_4)$  cannot be larger than  $(\mathbb{Z}_3 \times \mathbb{Z}_3) \rtimes \mathbb{Z}_4$ . Suppose that the automorphism  
 322 (12) is induced by a homeomorphism  $f$ . By Lemma 1,  $f$  must be orientation reversing. But  $f(\overline{456}) =$   
 323  $\overline{456}$ , which is impossible because  $\overline{456}$  contains only right handed trefoils. Thus  $\text{TSG}(\Gamma_4) \not\cong S_2[S_3]$ .  
 324 Note that the only proper subgroup of  $S_2[S_3]$  containing  $(\mathbb{Z}_3 \times \mathbb{Z}_3) \rtimes \mathbb{Z}_4$  is  $(\mathbb{Z}_3 \times \mathbb{Z}_3) \rtimes \mathbb{Z}_4$ . Thus  
 325  $\text{TSG}(\Gamma_4) \cong (\mathbb{Z}_3 \times \mathbb{Z}_3) \rtimes \mathbb{Z}_4$ .

**Table 5.** Non-trivial positively realizable groups for  $K_6$ 

Subgroup	Positively Realizable	Reason
$A_5$	No	By $A_5$ Theorem
$S_4$	No	By $S_4$ Theorem
$A_4$	No	By $A_4$ Theorem
$D_6$	Yes	By Figure 17
$D_5$	Yes	By Figure 18
$D_4$	No	By Lemma 2
$D_3 \times D_3$	Yes	By Figure 19
$D_3 \times \mathbb{Z}_3$	Yes	By modifying Figure 19
$D_3$	Yes	By Subgroup Theorem
$D_2$	Yes	By Subgroup Theorem
$\mathbb{Z}_6$	Yes	By Subgroup Theorem
$\mathbb{Z}_5$	Yes	By Subgroup Theorem
$\mathbb{Z}_4$	No	By Lemma 2
$(\mathbb{Z}_3 \times \mathbb{Z}_3) \rtimes \mathbb{Z}_2$	Yes	By modifying Figure 19
$\mathbb{Z}_3 \times \mathbb{Z}_3$	Yes	By modifying Figure 19
$\mathbb{Z}_3$	Yes	By Subgroup Theorem
$\mathbb{Z}_2$	Yes	By Subgroup Theorem

326 Now let  $\Gamma$  be the embedding of  $K_6$  illustrated in Figure 20. Observe that the linking number  
 327  $\text{lk}(\overline{135}, \overline{246}) = \pm 1$ , but  $\text{lk}(\overline{136}, \overline{245}) = 0$ . Thus the automorphism (56) cannot be induced by a  
 328 homeomorphism of  $(S^3, \Gamma)$ . Since every homeomorphism of  $(S^3, \Gamma)$  takes  $\overline{1234}$  to itself, it follows  
 329 that  $\text{TSG}(\Gamma) \leq D_4$ . The automorphism (1234)(56) is induced by a rotation followed by a reflection and  
 330 an isotopy. In addition the automorphism (14)(23)(56) is induced by turning the figure upside down.  
 331 Thus  $\text{TSG}(\Gamma) \cong D_4$  generated by the automorphisms (1234)(56) and (14)(23)(56).

**Figure 20.**  $\text{TSG}(\Gamma) \cong D_4$ .

332 Now let  $\Gamma'$  be obtained from Figure 20 by replacing the knot  $4_1$  with the non-invertible and positively  
 333 achiral knot  $12_{427}$ . Then the square  $\overline{1234}$  can no longer be inverted. In this case (1234)(56) generates  
 334  $\text{TSG}(\Gamma')$  and thus  $\text{TSG}(\Gamma') \cong \mathbb{Z}_4$ .



335 For the next few groups we will use the following lemma.

336 **4-Cycle Theorem.** [5] For any embedding  $\Gamma$  of  $K_6$  in  $S^3$ , and any labelling of the vertices of  $K_6$  by the  
337 numbers 1 through 6, there is no homeomorphism of  $(S^3, \Gamma)$  which induces the automorphism (1234).

338 Consider the subgroup  $\mathbb{Z}_5 \rtimes \mathbb{Z}_4 \leq \text{Aut}(K_6)$ . The presentation of  $\mathbb{Z}_5 \rtimes \mathbb{Z}_4$  as a subgroup of  $S_6$  gives  
339 the relation  $x^{-1}yx = y^2$  for some elements  $x, y \in \mathbb{Z}_5 \rtimes \mathbb{Z}_4$  of orders 4 and 5 respectively. Suppose that  
340 for some embedding  $\Gamma$  of  $K_6$ , we have  $\text{TSG}(\Gamma) \cong \mathbb{Z}_5 \rtimes \mathbb{Z}_4$ . Without loss of generality, we can assume  
341 that  $y = (12345)$  satisfies the relation  $x^{-1}yx = y^2$ . By the 4-Cycle Theorem, any order 4 element of  
342  $\text{TSG}(\Gamma)$  must be of the form  $x = (abcd)(ef)$ . However, there is no element in  $\text{Aut}(K_6)$  of the form  
343  $x = (abcd)(ef)$  that together with  $y = (12345)$  satisfies this relation. Thus there can be no embedding  
344  $\Gamma$  of  $K_6$  in  $S^3$  such that  $\text{TSG}(\Gamma) \cong \mathbb{Z}_5 \rtimes \mathbb{Z}_4$ .

345 Now consider the subgroup  $\mathbb{Z}_4 \times \mathbb{Z}_2 \leq \text{Aut}(K_6)$ . By the 4-Cycle Theorem, without loss of generality  
346 we may assume that if  $\text{TSG}(\Gamma)$  contains an element of order 4 for some embedding  $\Gamma$  of  $K_6$ , then  
347  $\text{TSG}(\Gamma)$  contains the element (1234)(56). Computation shows that the only transposition in  $\text{Aut}(K_6)$   
348 that commutes with (1234)(56) is (56), which cannot be an element of  $\text{TSG}(\Gamma)$  since this would imply  
349 that (1234) is an element of  $\text{TSG}(\Gamma)$ . Furthermore the only order 2 element of  $\text{Aut}(K_6)$  that commutes  
350 with (1234)(56) and is not a transposition is (13)(24), which is already in the group generated by  
351 (1234)(56). Thus there is no embedding  $\Gamma$  of  $K_6$  in  $S^3$  such that  $\text{TSG}(\Gamma)$  contains the group  $\mathbb{Z}_4 \times \mathbb{Z}_2$ .  
352 This rules out all of the groups  $S_4 \times \mathbb{Z}_2$ ,  $D_4 \times \mathbb{Z}_2$  and  $\mathbb{Z}_4 \times \mathbb{Z}_2$  as possible topological symmetry groups  
353 for embeddings of  $K_6$  in  $S^3$ .

354 For the group  $\mathbb{Z}_2 \times \mathbb{Z}_2 \times \mathbb{Z}_2$  we will use the following result.

355 **Conway Gordon.** [1] For any embedding  $\Gamma$  of  $K_6$  in  $S^3$ , the mod 2 sum of the linking numbers of all  
356 pairs of complementary triangles in  $\Gamma$  is 1.

357 Now suppose that for some embedding  $\Gamma$  of  $K_6$  in  $S^3$  we have  $\text{TSG}(\Gamma) \cong \mathbb{Z}_2 \times \mathbb{Z}_2 \times \mathbb{Z}_2$ . It can  
358 be shown that the subgroup  $\mathbb{Z}_2 \times \mathbb{Z}_2 \times \mathbb{Z}_2 \leq \text{Aut}(K_6)$  contains three disjoint transpositions. Without  
359 loss of generality we can assume that  $\text{TSG}(\Gamma)$  contains (13), (24), and (56), which are induced by  
360 homeomorphisms  $h, f$ , and  $g$  of  $(S^3, \Gamma)$  respectively. Since any three vertices of  $\Gamma$  determine a pair of  
361 disjoint triangles, we can use a triple of vertices to represent a pair of disjoint triangles. For example,  
362 we use the triple 123 to denote the pair of triangles  $\overline{123}$  and  $\overline{456}$ . With this notation, the orbits of the ten  
363 pairs of disjoint triangles in  $K_6$  under the group  $\langle (13), (24), (56) \rangle$  are:

$$\{123, 143\}, \{124, 324\}, \{125, 325, 145, 126\}, \{135, 136\}$$

364 Since  $h, f$ , and  $g$  are homeomorphisms of  $(S^3, \Gamma)$  the links in a given orbit all have the same (mod  
365 2) linking number. Since each of these orbits has an even number of pair of triangles, this contradicts  
366 Conway Gordon. Thus  $\mathbb{Z}_2 \times \mathbb{Z}_2 \times \mathbb{Z}_2 \not\cong \text{TSG}(\Gamma)$ . Hence  $\mathbb{Z}_2 \times \mathbb{Z}_2 \times \mathbb{Z}_2$  is not realizable for  $K_6$

367 Table 6 summarizes our realizability results for  $K_6$ . Recall that for  $n = 4$  and  $n = 5$  every subgroup  
368 of  $S_n$  is realizable for  $K_n$ . However, as we see from Table 6, this is not true for  $n = 6$ .

**Table 6.** Non-trivial realizable groups for  $K_6$ 

Subgroup	Realizable	Reason
$S_6$	No	$TSG_+(K_6)$ cannot be $S_6$ or $A_6$
$A_6$	No	$TSG_+(K_6)$ cannot be $A_6$
$S_5$	No	$TSG_+(K_6)$ cannot be $S_5$ or $A_5$
$A_5$	No	$TSG_+(K_6)$ cannot be $A_5$
$S_4 \times \mathbb{Z}_2$	No	$TSG_+(K_6)$ cannot be $S_4 \times \mathbb{Z}_2$ or $S_4$
$S_4$	No	$TSG_+(K_6)$ cannot be $S_4$ or $A_4$
$A_4 \times \mathbb{Z}_2$	No	$TSG_+(K_6)$ cannot be $A_4 \times \mathbb{Z}_2$ or $A_4$
$A_4$	No	$TSG_+(K_6)$ cannot be $A_4$
$D_6$	Yes	Positively realizable
$D_5$	Yes	Positively realizable
$D_4 \times \mathbb{Z}_2$	No	$TSG_+(K_6)$ cannot be $D_4 \times \mathbb{Z}_2$ , $D_4$ , $\mathbb{Z}_4 \times \mathbb{Z}_2$ , $\mathbb{Z}_2 \times \mathbb{Z}_2 \times \mathbb{Z}_2$
$D_4$	Yes	By Figure 20
$S_2[S_3]$	Yes	By Figure 19
$D_3 \times D_3$	Yes	Positively realizable
$D_3 \times \mathbb{Z}_3$	Yes	Positively realizable
$D_3$	Yes	Positively realizable
$D_2$	Yes	Positively realizable
$\mathbb{Z}_6$	Yes	Positively realizable
$\mathbb{Z}_5 \rtimes \mathbb{Z}_4$	No	By 4-Cycle Theorem
$\mathbb{Z}_5$	Yes	Positively realizable
$\mathbb{Z}_4 \times \mathbb{Z}_2$	No	By 4-Cycle Theorem
$\mathbb{Z}_4$	Yes	By modifying Figure 20
$(\mathbb{Z}_3 \times \mathbb{Z}_3) \rtimes \mathbb{Z}_4$	Yes	By modifying Figure 19
$(\mathbb{Z}_3 \times \mathbb{Z}_3) \rtimes \mathbb{Z}_2$	Yes	Positively realizable
$\mathbb{Z}_3 \times \mathbb{Z}_3$	Yes	Positively realizable
$\mathbb{Z}_3$	Yes	Positively realizable
$\mathbb{Z}_2 \times \mathbb{Z}_2 \times \mathbb{Z}_2$	No	By Conway Gordon Theorem
$\mathbb{Z}_2$	Yes	Positively realizable

### 369 Acknowledgements

370 The first author would like to thank Claremont Graduate University for its support while he pursued  
 371 the study of Topological Symmetry Groups for his Ph.D thesis. The second author would like to thank  
 372 the Institute for Mathematics and its Applications at the University of Minnesota for its hospitality while  
 373 she was a long term visitor in the fall of 2013.

### 374 References

375 1. Conway, J.; Gordon C. Knots and links in spatial graphs, *J. Graph Theory*, **7** (1983), 445-453.

- 376 2. Chambers D.; Flapan E.; O'Brien J., Topological symmetry groups of  $K_{4r+3}$ , *Discrete and*  
377 *Continuous Dynamical Systems*, **4** (2011), 1401-1411.
- 378 3. Flapan E. When Topology Meets Chemistry, *Cambridge University Press and the Mathematical*  
379 *Association of America* (2000).
- 380 4. Flapan E. Rigidity of Graph Symmetries in the 3-Sphere, *Journal of Knot Theory and its*  
381 *Ramifications*, **4** (1995), 373-388.
- 382 5. Flapan E. Symmetries of Möbius Ladders, *Math. Ann.*, **283** (1989), 271-283.
- 383 6. Flapan E.; Mellor B.; Naimi R. Complete graphs whose topological symmetry groups are polyhedral,  
384 *Algebraic and Geometric Topology*, **11**, (2011), 1405-1433.
- 385 7. Flapan E.; Mellor B.; Naimi R. Spatial graphs with local knots, *Revista Matemática Complutense*,  
386 **25**, (2012), 493-510.
- 387 8. Flapan E.; Mellor B.; Naimi R.; Yoshizawa M. Classification of topological symmetry groups of  $K_n$ ,  
388 to appear, *Topology Proceedings*, **43**, (2014).
- 389 9. Flapan E.; Naimi R.; Pommersheim J.; Tamvakis H. Topological symmetry groups of graphs  
390 embedded in the 3-sphere, *Commentarii Mathematici Helvetici*, **80** (2005), 317-354.
- 391 10. Flapan E.; Naimi R.; Tamvakis H. Topological symmetry groups of complete graphs in the 3-sphere,  
392 *Journal of the London Mathematical Society*, **73** (2006), 237-251.
- 393 11. Flapan E.; Tamvakis H. Topological symmetry groups of graphs in 3-manifolds, *Proc. Amer. Math.*  
394 *Soc.*, **141** (2013), 1423-1436.
- 395 12. Frucht R. On the groups of repeated graphs, *Bull. Amer. Math. Soc.*, **55** (1949), 418-420.
- 396 13. Hartley R. On knots with free period, *Canad. J. Math.*, **33** (1981), 91-102.
- 397 14. Hoste J.; Thistlethwaite M. <http://www.math.utk.edu/~morwen/knotscape.html>.
- 398 15. Pfeiffer Götz <http://schmidt.nuigalway.ie/subgroups/s5.pdf>.
- 399 16. Pfeiffer Götz <http://schmidt.nuigalway.ie/subgroups/s6.pdf>.
- 400 17. Simon J. A Topological Approach to the Stereochemistry of Nonrigid Molecules, *Studies in*  
401 *Physical and Theoretical Chemistry*, **51** (1987), 43-75.
- 402 18. Smith P. A. Transformations of Finite Period II, *Annals of Math.*, **40** (1939), 690-711.
- 403 19. Trotter H. F. Periodic automorphisms of groups and knots, *Duke J. Math.*, **28** (1961), 553-557.
- 404 20. Wikipedia, [http://groupprops.subwiki.org/wiki/Subgroup\\_structure\\_of\\_symmetric\\_group:S5](http://groupprops.subwiki.org/wiki/Subgroup_structure_of_symmetric_group:S5).

405 © November 8, 2017 by the authors; submitted to *Symmetry* for possible open access  
406 publication under the terms and conditions of the Creative Commons Attribution license  
407 <http://creativecommons.org/licenses/by/3.0/>.