

REGRESSION TREES FOR LONGITUDINAL AND MULTIRESPONSE DATA

BY WEI-YIN LOH¹ AND WEI ZHENG

University of Wisconsin–Madison and Sanofi-Aventis U.S. LLC

Previous algorithms for constructing regression tree models for longitudinal and multiresponse data have mostly followed the CART approach. Consequently, they inherit the same selection biases and computational difficulties as CART. We propose an alternative, based on the GUIDE approach, that treats each longitudinal data series as a curve and uses chi-squared tests of the residual curve patterns to select a variable to split each node of the tree. Besides being unbiased, the method is applicable to data with fixed and random time points and with missing values in the response or predictor variables. Simulation results comparing its mean squared prediction error with that of MVPART are given, as well as examples comparing it with standard linear mixed effects and generalized estimating equation models. Conditions for asymptotic consistency of regression tree function estimates are also given.

1. Introduction. A regression tree model is a nonparametric estimate of a regression function constructed by recursively partitioning a data set with the values of its predictor X variables. CART [Breiman et al. (1984)] is one of the oldest algorithms. It yields a piecewise-constant estimate by recursively partitioning the data using binary splits of the form $X \leq c$ if X is ordinal, and $X \in A$ if X is categorical. The impurity of a node t of the tree is defined as the sum of squared deviations $i(t) = \sum (y - \bar{y}_t)^2$, where \bar{y}_t is the sample mean of response variable Y in t and the sum is over the y values in t . The split of t into subnodes t_L and t_R that maximizes the reduction in node impurity $i(t) - i(t_L) - i(t_R)$ is selected. Partitioning continues until either the X or the y values are constant in a node, or the node sample size is below a pre-specified threshold. Then the tree is pruned with the help of

Received August 2011; revised August 2012.

¹Supported in part by U.S. Army Research Office Grant W911NF-09-1-0205 and National Institutes of Health Grant P50CA143188.

Key words and phrases. CART, decision tree, generalized estimating equation, linear mixed effects model, lowess, missing values, recursive partitioning, selection bias.

<p>This is an electronic reprint of the original article published by the Institute of Mathematical Statistics in <i>The Annals of Applied Statistics</i>, 2013, Vol. 7, No. 1, 495–522. This reprint differs from the original in pagination and typographic detail.</p>

an independent test sample or by cross-validation and the subtree with the lowest estimated mean squared error is selected.

Several attempts have been made to extend CART to longitudinal and multiresponse data, often by using likelihood-based functions as node impurity measures. The earliest attempt for longitudinal data seems to be Segal (1992), which uses the likelihood of an autoregressive or compound symmetry model. If values are missing from the Y variable, parameter estimation is performed by the EM algorithm. Computational difficulties in estimating the covariance matrices limit the method to data observed at equally-spaced time points. Abdollell et al. (2002) follow the same approach, but use a likelihood-ratio test statistic as the impurity function.

Zhang (1998) extends the CART approach to multiple binary response variables, assuming there are no missing values in the Y variable. It uses as impurity function the log-likelihood of an exponential family distribution that depends only on the linear terms and the sum of second-order products of the responses. Zhang and Ye (2008) extend this idea to ordinal responses by first transforming them to binary-valued indicator functions. Again, the approach is hindered by the computational difficulties of having to compute covariance matrices at every node.

De'ath (2002) avoids the covariance computations by following the CART algorithm exactly except for two simple modifications: the sample mean is replaced by the d -dimensional sample mean and the node impurity is replaced by $i(t) = \sum_{k=1}^d i_k(t)$, where $i_k(t)$ is the sum of squared deviations about the mean of the k th response variable in t . The algorithm is implemented in the R package MVPART [De'ath (2012)]. Larsen and Speckman (2004) adopt the same approach, but use the Mahalanobis distance as node impurity, with covariance matrix estimated from the whole data set.

In a different direction, Yu and Lambert (1999) treat each longitudinal data vector as a random function or trajectory. Instead of fitting a longitudinal model to each node, they first reduce the dimensionality of the whole data set by fitting each data trajectory with a low-order spline curve. Then they use the estimated coefficients of the basis functions as multivariate responses to fit a regression tree model, with the mean coefficient vectors as predicted values and standardized squared error as node impurity. They recover the predicted trajectory in each node by reconstituting the spline function from the mean coefficient vector. They mention as an alternative the use of principal component analysis to reduce the data dimension and then fitting a multivariate regression tree model to the largest principal components.

A major weakness of CART is that its selection of variables for splits is biased toward certain types of variables. Because a categorical X with m unique values allows $(2^{m-1} - 1)$ splits of the data and an ordinal X with n unique values allows $(n - 1)$ splits, categorical variables with many unique values tend to have an advantage over ordinal variables in being

selected [Loh and Shih (1997), Shih (2004), Strobl, Boulesteix and Augustin (2007)]. This weakness is inherited by all multivariate extensions of CART, including MVPART [Hsiao and Shih (2007)]. Further, because reductions in node impurity from splitting are based on observations without missing values, variables with fewer missing values are more likely to yield larger reductions (and hence be selected for splitting) than those with more missing values; see Section 5 below.

GUIDE [Loh (2002)] avoids selection bias by replacing CART's one-step method of simultaneously selecting the split variable X and split set with a two-step method that first selects X and then finds the split set for the selected X . This approach makes it practicable for GUIDE to fit a nonconstant regression model in each node.

The goal of this article is to extend GUIDE to multivariate and longitudinal response variables. Section 2 briefly reviews the GUIDE variable selection method for univariate response variables. Section 3 extends it to multivariate responses and longitudinal data observed at fixed time points. The procedure is illustrated with an application to a data set on the strength and viscosity of concrete. Section 4 compares the selection bias and prediction accuracy of our method with MVPART in a simulation study. Section 5 deals with the problem of missing values, which can occur in the predictor as well as the response variables. We propose a solution and apply it to some data on the mental health of children that are analyzed in Fitzmaurice, Laird and Ware (2004) with a generalized estimating equation (GEE) approach. Section 6 further extends our method to longitudinal data with random time points. We illustrate it with an example on the hourly wages of high school dropouts analyzed in Singer and Willett (2003) with linear mixed effect (LME) models. Section 7 compares the prediction accuracy of our method with that of GEE and LME models in a simulation setting. Section 8 applies the ideas to simultaneously modeling two longitudinal series from a study on maternal stress and child illness analyzed in Diggle et al. (2002) with GEE logistic regression. Section 9 gives conditions for asymptotic consistency of the multivariate regression tree function estimates and Section 10 concludes the article with some remarks.

2. Univariate GUIDE algorithm. The GUIDE algorithm for a univariate response variable Y can fit a linear model in each node using one of several loss functions. For our purposes here, it suffices to review the algorithm for least-squares piecewise-constant models. The key idea is to split a node with the X variable that shows the highest degree of clustering in the signed residuals from a constant model fitted to the data in the node. If a predictor variable X has no effect on the true regression mean function, a plot of the residuals versus X should not exhibit systematic patterns. But if the mean is a function of X , clustering of the signed residuals is expected.

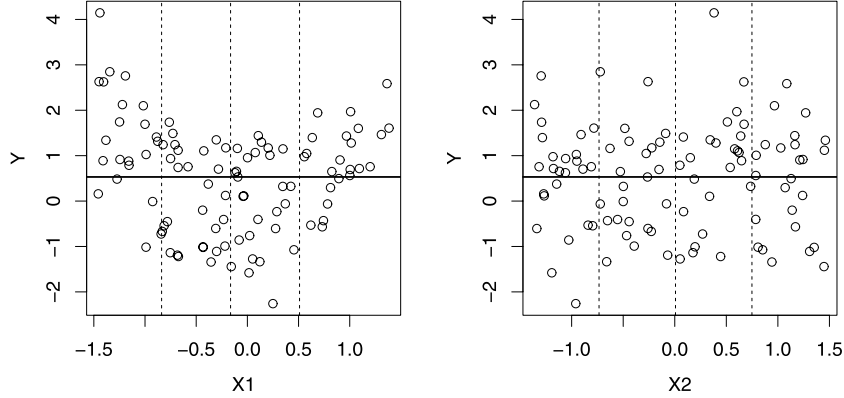

FIG. 1. Plots of Y versus X_1 and X_2 from data generated from the model $Y = X_1^2 + \varepsilon$. The horizontal line marks the sample mean of Y .

To illustrate, consider some data generated from the model $Y = X_1^2 + \varepsilon$, with X_1 and X_2 independent $U(-1.5, 1.5)$, that is, uniformly distributed on the interval $(-1.5, 1.5)$, and ε independent standard normal. Since the true regression function does not depend on X_2 , a piecewise-constant model should split on X_1 only. This is easily concluded from looking at plots of Y versus X_1 and X_2 , as shown in Figure 1. In the plot of Y versus X_1 , the positive residuals are clustered at both ends of the range of X_1 and the negative residuals near the center. No such clustering is obvious in the plot of Y versus X_2 .

GUIDE measures the degree of clustering by means of contingency table chi-squared tests. In each test, the values of X are grouped into a small number of intervals (indicated by the vertical dashed lines in Figure 1), with the groups forming the rows and the residual signs forming the columns of the table. The end points are computed such that each interval has approximately the same number of observations if X is uniformly distributed (see Algorithm 3.1 below for the definitions). Table 1 shows the table counts

TABLE 1
Contingency tables of X_1 and X_2 versus signs of residuals.
Chi-squared p -values are 0.005 and 0.404, respectively

	-	+		-	+
$-\infty < X_1 \leq -0.84$	5	17	$-\infty < X_2 \leq -0.73$	9	16
$-0.84 < X_1 \leq -0.16$	16	12	$-0.73 < X_2 \leq 0.01$	14	11
$-0.16 < X_1 \leq 0.51$	17	10	$0.01 < X_2 \leq 0.75$	9	16
$0.51 < X_1 < \infty$	6	17	$0.75 < X_2 < \infty$	12	13

and the chi-squared p -values for the data in Figure 1. If X is a categorical variable, its values are used to form the rows of the table.

GUIDE selects the variable with the smallest chi-squared p -value to split the node. Because the sample size in a node decreases with splitting, the p -values are approximate at best. Their exact values are not important, however, as they serve only to rank the variables for split selection. Similar p -value methods have been used in classification tree algorithms, for example, F-tests [Loh and Shih (1997)] and permutation tests [Hothorn, Hornik and Zeileis (2006)]. One benefit from using p -values is lack of selection bias, at least for sufficiently large sample sizes. This is due to the p -values being approximately identically distributed if all the X variables are independent of Y .

After a variable is selected, the split set is found by exhaustive search to maximize the reduction in the sum of squared residuals. A side (but practically important) benefit is significant computational savings over the CART method of searching for the best split set for *every* X . The procedure is applied recursively to construct an overly large tree. Then the tree is pruned using cross-validation as in the CART algorithm and the subtree with the smallest cross-validation estimate of mean squared error is selected.

3. Multiple response variables. We motivate our extension of GUIDE to multiple response variables with an analysis of some data on the strength and viscosity of concrete [Yeh (2007)] taken from the UCI Machine Learning Repository [Asuncion and Newman (2007)]. There are 103 complete observations on seven predictor variables (cement, slag, fly ash, water, superplasticizer (SP), coarse aggregate and fine aggregate, each measured in kg per cubic meter) and three response variables (slump and flow, in cm, and 28-day compressive strength in Mpa). Slag and fly ash are cement substitutes. Slump and flow measure the viscosity of concrete; slump is the vertical height by which a cone of wet concrete sags and flow is the horizontal distance by which it spreads. The objective is to understand how the predictor variables affect the values of the three response variables jointly.

Fitting a separate multiple linear regression model to each response is not enlightening, as the results in Table 2 show. Cement, fly ash, water and coarse aggregate are all significant (at the 0.05 level) for strength. The signs of their coefficients suggest that strength is increased by increasing the amounts of cement and fly ash and decreasing that of water and coarse aggregate. Since no variable is significant for slump, one may be further tempted to conclude that none is important for its prediction. This is false, because a linear regression for slump with only water and slag as predictors finds both to be highly significant. The problem is due to the design matrix being quite far from orthogonal (see Figure 2). Therefore, it is risky to interpret each regression coefficient by “holding the other variables con-

TABLE 2
Separate linear regression models, with p -values less than 0.05 in italics

	Slump		Flow		Strength	
	Estimate	p -value	Estimate	p -value	Estimate	p -value
(Intercept)	-88.525	0.66	-252.875	0.47	139.782	0.052
Cement	0.010	0.88	0.054	0.63	0.061	<i>0.008</i>
Slag	-0.013	0.89	-0.006	0.97	-0.030	0.352
Fly ash	0.006	0.93	0.061	0.59	0.051	<i>0.032</i>
Water	0.259	0.21	0.732	<i>0.04</i>	-0.233	<i>0.002</i>
SP	-0.184	0.63	0.298	0.65	0.10	0.445
CoarseAggr	0.030	0.71	0.074	0.59	-0.056	<i>0.045</i>
FineAggr	0.039	0.64	0.094	0.51	-0.039	0.178

stant.” Besides, the main effect models are most likely inadequate anyway. Inclusion of interaction terms, however, brings on other difficulties, such as knowing which terms and of what order to add, which makes interpretation even more challenging.

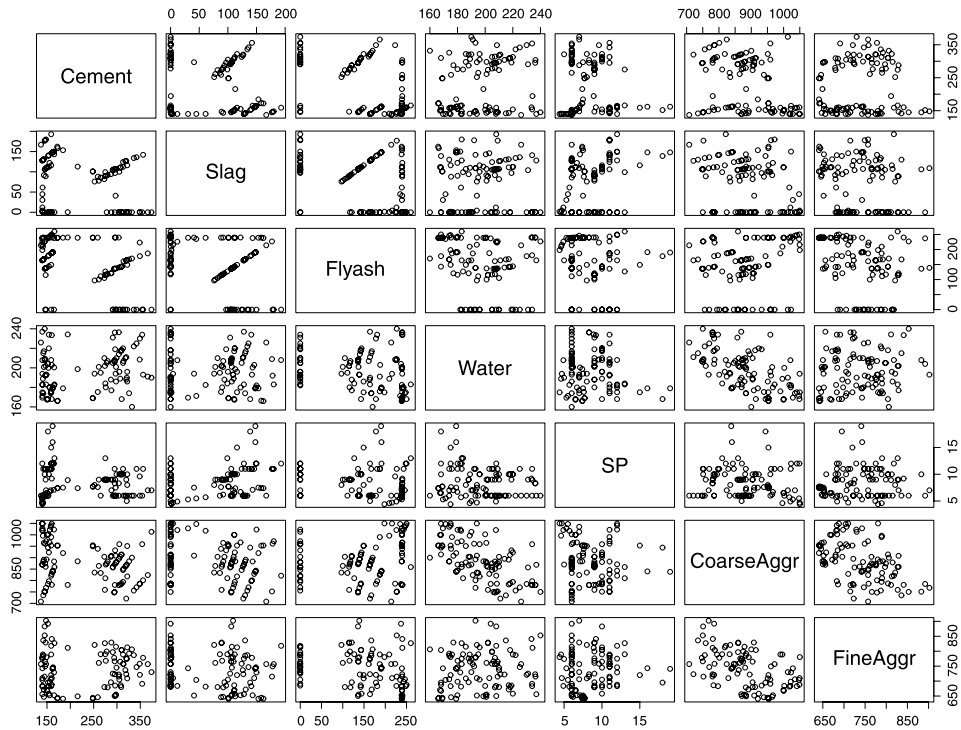

FIG. 2. *Plots of pairs of predictor variables for concrete data.*

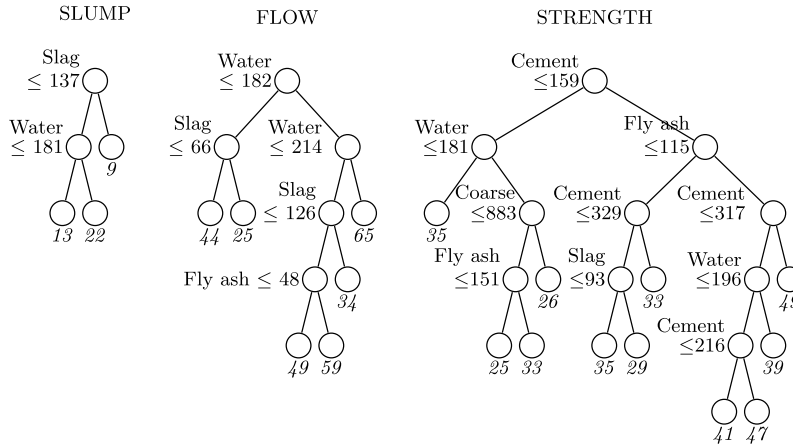

FIG. 3. Univariate GUIDE models for predicting slump (left), flow (middle) and strength (right) of concrete. At each node, a case goes to the left subnode if and only if the stated condition is satisfied. The predicted value is in italics below each terminal node.

Instead of controlling for the effects of other variables by means of an equation, a regression tree model achieves a similar goal by dividing the sample space into partitions defined by the values of the variables, thus effectively restricting the ranges of their values. Figure 3 shows three GUIDE tree models, one for each response variable, with predicted values beneath the terminal nodes. We see that less slag and more water yield larger values of slump, more water yields larger values of flow, and higher amounts of cement and fly ash produce the strongest concrete. Although it is easier to interpret the tree structures than the coefficients of the linear models, it is still nontrivial to figure out from the three trees how the variables affect the response variables jointly. For example, the trees show that (i) slump is least when slag > 137 , (ii) flow is least when water ≤ 182 and slag > 66 , and (iii) strength is greatest when cement > 317 and fly ash > 115 . We may thus conclude that the intersection of these conditions yields the strongest and least viscous concrete. But there are no observations in the intersection.

A single tree model that simultaneously predicts all three responses would not have these difficulties. Ideally, such an algorithm would produce compact trees with high predictive accuracy and without variable selection bias. The main hurdle in extending GUIDE to multiple response variables is unbiased variable selection. Once this problem is solved, the rest of the method follows with a simple modification to the node impurity function.

Lee (2005) proposes one extension, applicable to ordinal X variables only, that fits a GEE model to the data in each node. It classifies each observation into one of two groups according to the sign of its average residual, $d^{-1} \sum_{k=1}^d \hat{\epsilon}_{ik}$, where $\hat{\epsilon}_{ik}$ is the residual of the i th observation for the k th response variable. Then a two-sample t -test is performed for each X and the

one with the smallest p -value is selected to split the node. The split point is a weighted average of the X values in the two groups. If the smallest p -value exceeds a pre-specified threshold, splitting stops.

Lee's solution is deficient in several respects. First, the p -value threshold is hard to specify, because it depends on characteristics of the data set, such as the number and type of variables and the sample size. Second, it is inapplicable to categorical predictor variables. Third, it is inapplicable to data with missing predictor or response values. Finally, for the ultimate goal of clustering the response vectors into groups with similar patterns, classifying them into two groups by the signs of their *average* residuals is potentially ineffective, because two response vectors can have very dissimilar patterns and yet have average residuals with the same sign.

A more effective extension can be obtained by working with the residual sign vectors instead. Let (Y_1, Y_2, \dots, Y_d) be the d response variables. At each node, we fit the data with the sample mean vector and compute the residual vectors. Since each residual can have a positive or nonpositive sign, there are 2^d possible patterns for the residual sign vector. To determine if a predictor variable X is independent of the residual pattern, we form a contingency table with the sign patterns as the columns and the (grouped, if X is not categorical) values of X as the rows and find the p -value of the chi-squared test of independence. Specific details are given in the algorithm below. Other aspects of the method are the same as in the univariate GUIDE, except for the node impurity function being the sum of (normalized, if desired) squared errors.

ALGORITHM 3.1. Split variable selection at each node t :

- (1) Find $\bar{y} = (\bar{y}_1, \dots, \bar{y}_d)$, where \bar{y}_k is the mean of the nonmissing values of the k th response variable in t .
- (2) Define the sign vector $Z = (Z_1, Z_2, \dots, Z_d)$ such that $Z_k = 1$ if $Y_k > \bar{y}_k$ and $Z_k = -1$ if $Y_k \leq \bar{y}_k$. If Y_k is missing, the user can choose either $Z_k = 1$ or $Z_k = -1$ (default), with the same choice used for all nodes.
- (3) Main effect tests. Do this for each X variable:
 - (a) If X is not categorical, group its values into m intervals. Let \bar{x} and s denote the sample mean and standard deviation of the nonmissing values of X in t . If the number of data points is less than $5 \times 2^{d+2}$, set $m = 3$ and define the interval end points to be $\bar{x} \pm s\sqrt{3}/3$. Otherwise, set $m = 4$ and define the interval end points as $\{\bar{x}, \bar{x} \pm s\sqrt{3}/2\}$.
 - (b) If X is categorical, use its categories to form the groups.
 - (c) Create an additional group for missing values if X has any.
 - (d) Form a contingency table with the 2^d patterns of Z as columns and the X -groups as rows, and compute the p -value of the chi-squared test of independence.
- (4) If the smallest p -value is less than $0.05/d$, select the associated X variable and exit.

- (5) Otherwise, do these interaction tests for each pair of variables X_i, X_j :
 - (a) If X_i is noncategorical, split its range into two intervals A_{i1} and A_{i2} at its sample mean. If X_i is categorical, let A_{ik} denote the singleton set containing its k th value. Do the same for X_j .
 - (b) Define the sets $B_{k,m} = \{(x_i, x_j) : x_i \in A_{ik}, x_j \in A_{jm}\}$, for $k, m = 1, 2, \dots$.
 - (c) Form a contingency table with the Z patterns as columns and $\{B_{k,m}\}$ as rows and compute its p -value.
- (6) If the smallest p -value from the interaction tests is less than $0.05/\{d(d-1)\}$, select the associated pair of predictors.
- (7) Otherwise, select the X with the smallest main effect p -value from step (4).

The value of m in step (3)(a) is chosen to keep the row-dimension of the table as small as possible without sacrificing its ability to detect patterns. The interval end points are chosen so that if X has a uniform distribution, each interval has roughly the same number of observations. If $d = 1$, these definitions reduce to those in the univariate GUIDE algorithm [Loh (2009), page 1716].

If a noncategorical variable is selected in step (4), the split $X \leq c$ is found by searching over all midpoints c of consecutive order statistics to minimize the total sum of squared deviations of the the two subnodes. If X is a categorical variable, the search for a split of the form $X \in A$ can be computationally daunting if X takes many values. To obtain a quick but approximate solution, we create a classification variable from the Z patterns in each node and then use the method described in Loh [(2009), the Appendix] for classification trees to find the set A . We also use the procedures in Loh (2009) to find the split set if a pair of variables is selected in step (6).

For the concrete data, the values of each X variable are grouped into three intervals. Table 3 shows the contingency table formed by the residual signs and the groups for water, which has the smallest chi-squared p -value of 8×10^{-5} . The top half of Figure 4 shows the tree model after pruning by ten-fold cross-validation. We will use the description ‘‘multivariate GUIDE’’ to refer to this method from now on. Predicted values of the re-

TABLE 3
Contingency table formed by cross-tabulating residual signs vs. water groups

	Z_1	-	-	-	-	+	+	+	+
	Z_2	-	-	+	+	-	-	+	+
	Z_3	-	+	-	+	-	+	-	+
Water ≤ 185.5		5	16	0	0	1	4	6	2
$185.5 < \text{Water} \leq 208.8$		6	2	1	0	4	1	14	13
Water > 208.8		3	2	1	1	0	0	13	8

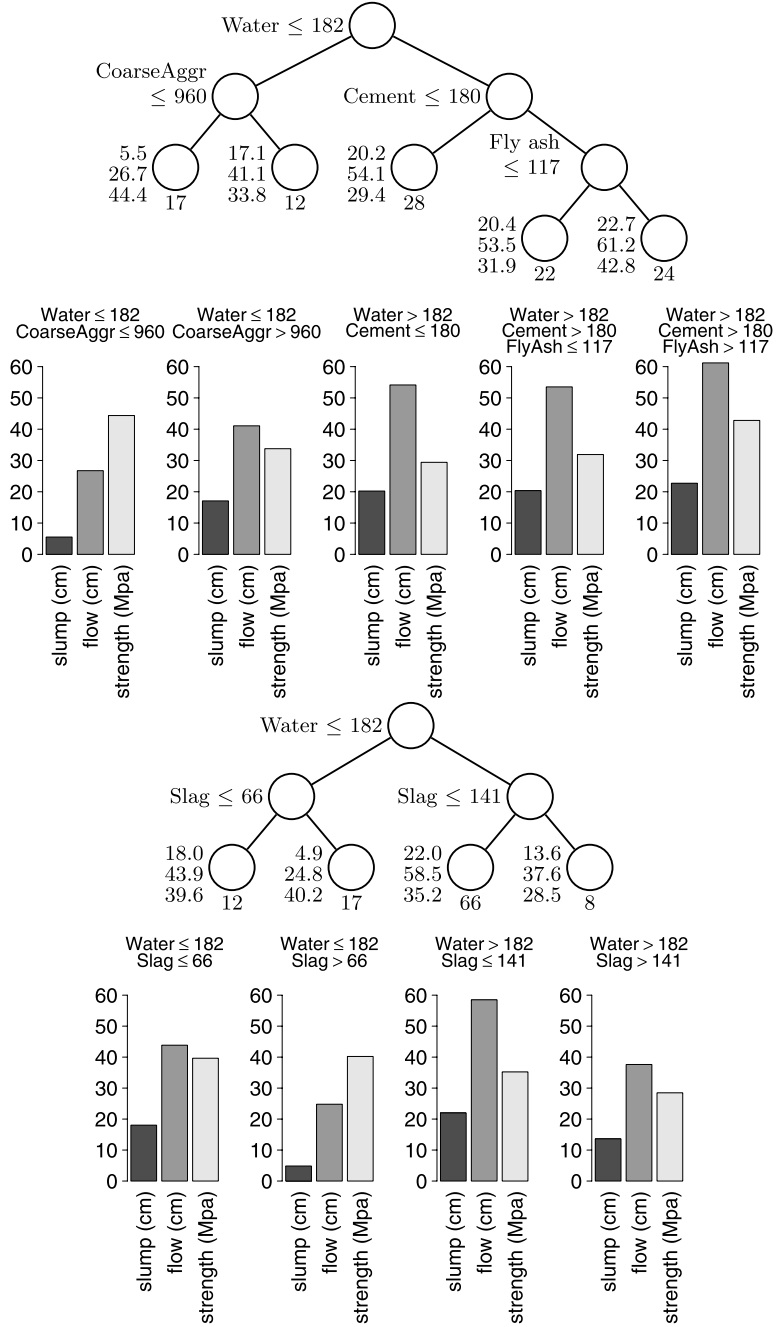

FIG. 4. Multivariate GUIDE (top) and MVPART (bottom) models for the concrete data. Sample sizes are beneath and predicted values (slump, flow and strength, resp.) are on the left of each node. Barplots show the predicted values in the terminal nodes of the trees.

sponse variables are shown by the heights of the bars in the figure. The strongest and most viscous concrete is obtained with water $\leq 182 \text{ kg/m}^3$ and coarse aggregate $\leq 960 \text{ kg/m}^3$. This is consistent with these two variables having negative coefficients for strength in Table 2. The tree model also shows that the combination of water $> 182 \text{ kg/m}^3$, cement $> 180 \text{ kg/m}^3$ and fly ash $> 117 \text{ kg/m}^3$ yields concrete that is almost as strong but least viscous. Thus, it is possible to make strong concrete with low or high viscosity. The combination predicting concrete with the least strength is water $> 182 \text{ kg/m}^3$ and cement $\leq 180 \text{ kg/m}^3$. The MVPART [De'ath (2012)] model is shown in the bottom half of Figure 4. Its first split is the same as that of GUIDE, but the next two splits are on slag.

To compare the prediction accuracy of the methods, we first normalize the values of the three response variables to have zero mean and unit variance and then apply leave-one-out cross-validation to estimate their sum of mean squared prediction errors of the pruned trees, where the sum is over the three response variables. The results are quite close, being 1.957, 2.097 and 2.096 for univariate GUIDE, multivariate GUIDE and MVPART, respectively. As we will see in the next section, univariate trees tend to have lower prediction error than multivariate trees if the response variables are uncorrelated and higher prediction error when the latter are correlated. In this example, slump and flow are highly correlated ($\text{cor} = 0.91$) but each is weakly correlated with strength (-0.22 and -0.12 , resp.). Thus, there is a cancellation effect.

4. Selection bias and prediction accuracy. We carried out some simulation experiments to further compare the variable selection bias and prediction accuracy of GUIDE and MVPART. To show the selection bias of MVPART, we took the concrete data as a population distribution and drew bootstrap samples from it of the same size ($n = 103$). Then we randomly permuted the values in each predictor variable to render it independent of the response variables. An unbiased algorithm now should select each variable with the same probability $1/7 = 0.143$ to split the root node. The left panel of Figure 5 shows the estimated selection probabilities for GUIDE and MVPART from 5000 simulation trials. The estimates for GUIDE are all within two simulation standard errors of $1/7$ but those of MVPART are not: they are roughly proportional to the number of unique values of the variables in the data, namely, 80, 63, 58, 70, 32, 92 and 90 for cement, slag, fly ash, water, SP, coarse aggregate and fine aggregate, respectively.

To demonstrate the bias of MVPART toward selecting variables with more split sets, we added two independent predictor variables, C_2 and C_{20} , where C_k denotes a multinomial variable with equal probabilities on k categories. Variable C_2 allows only one split but variable C_{20} has $2^{19} - 1 = 524,287$ splits. An unbiased method now should select each variable with probability $1/9 = 0.111$. The results, based on 5000 simulation trials, are shown in the right

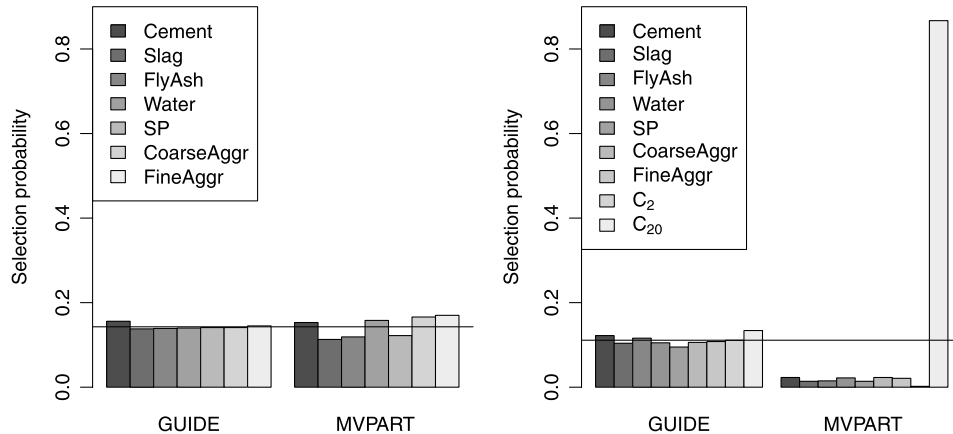

FIG. 5. Estimated probabilities (based on 5000 simulation trials) that each predictor variable is selected to split the root node when all are independent of the response variables. Standard errors are less than 0.005. Variable C_k is multinomial with equal probabilities on k categories. The horizontal line marks the level for unbiased selection.

panel of Figure 5. GUIDE is again essentially unbiased (within simulation error), but MVPART selects C_{20} more than 86% of the time and C_2 only 10 out of 5000 times.

To compare the prediction accuracies of MVPART and univariate and multivariate GUIDE, we use three simulation scenarios, with each having seven predictor variables and three response variables. The values of the response variables are generated by the equation $Y_k = \mu_k + \varepsilon$, $k = 1, 2, 3$, where the ε are independent normal variables with mean 0 and variance 0.25. The three scenarios are as follows:

$$(4.1) \quad (\mu_1, \mu_2, \mu_3) = (X_1, X_2, X_3),$$

$$(4.2) \quad (\mu_1, \mu_2, \mu_3) = (X_1 + X_2, X_1 + X_2, X_1 + X_2),$$

$$(4.3) \quad (\mu_1, \mu_2, \mu_3) = \begin{cases} (1, -1, 0), & X_1 X_2 > 0, \\ (0, 0, 1), & X_1 X_2 \leq 0. \end{cases}$$

Scenarios (4.1) and (4.2) are standard linear regression models. Univariate GUIDE should be most accurate in scenario (4.1), because each mean response depends on a different predictor variable. The same may not be true for scenario (4.2), where a multivariate regression tree may be able to utilize the joint information among the response variables. Scenario (4.3) has a piecewise-constant tree structure, but it can be challenging due to the absence of main effects.

Two simulation experiments were performed. In the first experiment, variables X_1, \dots, X_7 are mutually independent $U(-0.5, 0.5)$. For each scenario, 100 training samples are generated in each simulation trial and a

TABLE 4

Estimated mean squared error (MSE) and number of terminal nodes (Nodes) using 100 training samples in 1000 simulation trials. Standard errors of MSE in parentheses. “Univariate GUIDE” refers to the model with a separate tree for each response variable

Scenario	Univariate GUIDE		Multivariate GUIDE		MVPART	
	MSE $\times 10^2$	Nodes	MSE $\times 10^2$	Nodes	MSE $\times 10^2$	Nodes
X_1, \dots, X_7 are independent $U(-0.5, 0.5)$						
(4.1)	14.1 (0.1)	5.7	21.9 (0.1)	3.4	22.2 (0.1)	3.1
(4.2)	35.1 (0.2)	8.3	24.2 (0.2)	4.5	22.3 (0.2)	4.5
(4.3)	33.0 (0.5)	11.8	12.3 (0.4)	4.2	68.8 (0.7)	2.7
X_1, \dots, X_6 are $N(0, V)$, X_7 is independent $U(-0.5, 0.5)$						
(4.1)	47.2 (0.3)	13.7	156.0 (0.7)	6.4	128.4 (0.6)	13.0
(4.2)	198.0 (1.2)	22.5	206.1 (1.4)	6.3	158.2 (1.2)	10.9
(4.3)	48.0 (0.6)	11.3	15.5 (0.5)	4.4	68.2 (0.8)	3.6

pruned regression tree model (using the CART pruning method) constructed by each method. One hundred independent test values $(X_{1j}, X_{2j}, \dots, X_{7j})$, $j = 1, \dots, 100$, are generated to evaluate the models. Let $(\mu_{1j}, \mu_{2j}, \mu_{3j})$ denote the mean response values for the j th test sample, $(\hat{\mu}_{1j}, \hat{\mu}_{2j}, \hat{\mu}_{3j})$ denote their predicted values, and $\text{MSE} = \sum_{j=1}^{100} \sum_{i=1}^3 (\hat{\mu}_{ij} - \mu_{ij})^2 / 100$ denote the estimated mean squared error.

The upper half of Table 4 shows the average values of MSE and their standard errors over 1000 simulation trials. The average numbers of terminal nodes are also shown (for the univariate GUIDE method, this is the sum of the number of terminal nodes of the separate trees). As expected, univariate GUIDE is more accurate than the multivariate tree methods in scenario (4.1), where the means are unrelated. On the other hand, multivariate GUIDE is more accurate in scenarios (4.2) and (4.3) because it can take advantage of the relationships among the response variables. The accuracy of MVPART is close to that of multivariate GUIDE, except in scenario (4.3), where it has difficulty detecting the interaction effect. The higher accuracy of multivariate GUIDE here is due to the interaction tests in step (5) of Algorithm 3.1.

In the second experiment, we generated (X_1, \dots, X_6) as multivariate normal vectors with zero mean and covariance matrix

$$V = \begin{pmatrix} 1 & 0 & r & r & 0 & 0 \\ 0 & 1 & 0 & 0 & r & r \\ r & 0 & 1 & r & 0 & 0 \\ r & 0 & r & 1 & 0 & 0 \\ 0 & r & 0 & 0 & 1 & r \\ 0 & r & 0 & 0 & r & 1 \end{pmatrix}$$

and $r = 0.5$. Thus, (X_1, X_3, X_4) is independent of (X_2, X_5, X_6) . As in the previous experiment, X_7 is independent $U(-0.5, 0.5)$. The results, given in the bottom half of the table, are quite similar to those in the first experiment, except in scenario (4.1), where MVPART has lower MSE than multivariate GUIDE, and in scenario (4.2), where univariate GUIDE has lower MSE than multivariate GUIDE. Notably, the average number of terminal nodes in the MVPART trees is about twice the average for multivariate GUIDE in these two scenarios. The larger number of nodes suggest that the trees may be splitting on the wrong variables more often. But because these variables are correlated with the correct ones and because of the effectiveness of pruning, the MSEs are not greatly increased.

5. Missing values. Missing values in the predictor variables do not present new challenges, as the method in univariate GUIDE can be used as follows [Loh (2009)]. If X has missing values, we create a “missing” group for it and carry out the chi-squared test with this additional group. Besides allowing all the data to be used, this technique can detect relationships between the missing patterns of X and the values of the response variables.

The search for a split set for a categorical X with missing values is no different from that for a categorical variable without missing values, because missing values are treated as an additional category. But if X is noncategorical and has missing values, we need to find the split point and a method to send cases with missing values through the split. For the first task, all splits at midpoints between consecutive order statistics of X are considered. All missing X values are temporarily imputed with the mean of the nonmissing values in the node. Because the sample mean usually belongs to the node with the greater number of observations, this typically sends the missing values to the larger node. The best among these splits is then compared with the special one that sends all missing values to one node and all nonmissing values to the other, and the one yielding the greater impurity reduction is selected.

Our approach to split selection is different from that of MVPART, which uses the CART method of searching for the split that maximizes the reduction in total sum of squared errors *among the observations nonmissing in the split variable*. As a consequence, MVPART has a selection bias toward variables with *fewer* missing values. This can be demonstrated using the procedure in Section 4, where we take bootstrap samples of the concrete data and randomly permute its predictor values. Figure 6 shows the selection probabilities before and after 80% of the values in FineAggr are made randomly missing, based on 5000 simulation trials. Variations in the GUIDE probabilities are all within three simulation standard errors of $1/7$, but those of MVPART are not. More importantly, there is a sharp drop in the selection probability of FineAggr due to missing values.

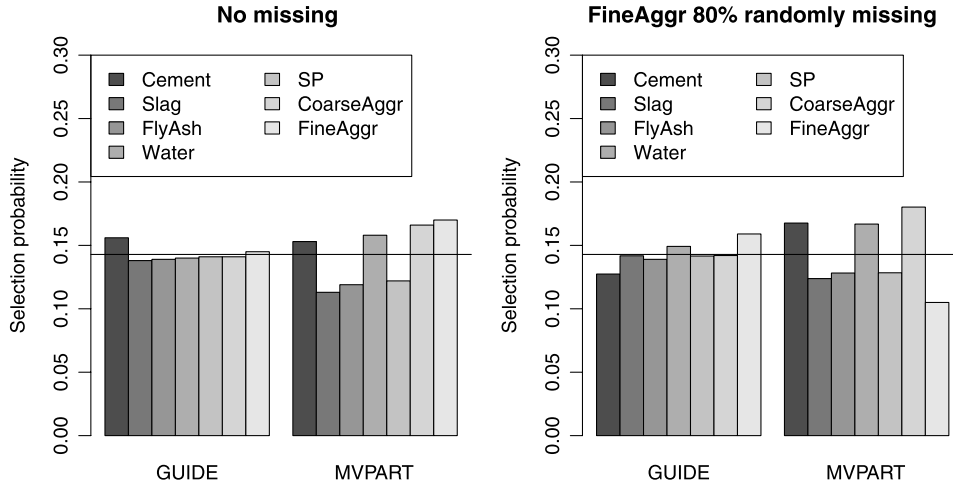

FIG. 6. *Estimated probabilities (from 5000 simulation trials) of variable selection when all variables are independent of the response variables. Standard errors are less than 0.005. The horizontal line marks the probability for unbiased selection.*

Missing values in a univariate response variable do not cause problems, because those observations are routinely omitted. But if the response is multidimensional, it is wasteful to omit an observation simply because one or more responses are missing, as MVPART and the methods of Abdollell et al. (2002) and Zhang (1998) require. Segal (1992) allows missing responses in longitudinal data, but only if the variable is continuous, is observed at equally-spaced time points, and the data in each node are fitted with an autoregressive or compound symmetry model. In our approach, if there are missing values in some but not all response variables, step (2) of Algorithm 3.1 takes care of them by giving the user the choice of $Z_k = -1$ or $Z_k = 1$ for missing Y_k . For split set selection, we compute the mean response for each Y_k from the nonmissing values in the node and the sum of squared errors from the nonmissing Y_k values only.

To illustrate these ideas, consider a data set from a survey of the mental health of 2501 children, analyzed in Fitzmaurice, Laird and Ware (2004), Section 16.5. One purpose of the survey was to understand the influence of parent status (single vs. not single) and child’s physical health (good vs. fair or poor) on the prevalence of externalizing behavior in the child. Each child was assessed separately by two “informants” (a parent and a teacher) on the presence or absence (coded 1 and 0, resp.) of delinquent or aggressive externalizing behavior. All the parent responses were complete, but 1073 children (43%) did not have teacher responses.

For child i , let $Y_{ij} = 1$ if the j th informant (where $j = 1$ refers to parent and $j = 2$ to teacher) reports externalizing behavior, and $Y_{ij} = 0$ otherwise.

TABLE 5
*Estimated GEE model for children’s mental health data, from
 Fitzmaurice, Laird and Ware (2004), page 438*

Variable	Estimate	SE	Z
Intercept	-1.685	0.100	-16.85
Parent informant (X_1)	-0.467	0.118	-3.96
Single parent status (X_2)	0.611	0.108	5.68
Fair or poor child health (X_3)	0.146	0.135	1.08
Informant \times child health (X_1X_3)	0.452	0.157	2.87

Assuming that the Y_{ij} are missing at random and the covariance between the two responses is constant, Fitzmaurice et al. use a generalized estimating equation (GEE) method to simultaneously fit this logistic regression model to the two responses:

$$\log\{P(Y_{ij} = 1)/P(Y_{ij} = 0)\} = \beta_0 + \beta_1x_{1ij} + \beta_2x_{2ij} + \beta_3x_{3ij} + \beta_{13}x_{1ij}x_{3ij}.$$

Here $x_{1ij} = 1$ if $j = 1$ and 0 otherwise, $x_{2ij} = 1$ if the parent is single and 0 otherwise, and $x_{3ij} = 1$ if the child’s health is fair or poor and 0 otherwise.

Table 5 shows the estimated coefficients from Fitzmaurice, Laird and Ware (2004), page 438. It suggests that a report of externalizing behavior is more likely if the informant is a teacher or the parent is single. The significant interaction implies that the probability is further increased if the informant is a parent and the child has fair or poor health.

The multivariate GUIDE model, using $Z_k = -1$ for missing Y_k values in step (2) of Algorithm 3.1, is shown in Figure 7. It splits first on child health and then on single parent status. (The model using $Z_k = 1$ for missing Y_k splits first on single parent status and then on child health, but its set of terminal nodes is the same.) The barplots below the terminal nodes compare the predicted proportions (means of Y_{ij}) of the parents and teachers who report externalizing behavior and the proportions of missing teacher responses. The interaction effect in the GEE model can be explained by the barplots: parent reports of externalizing behavior are less frequent than teacher reports except when the child’s health is not good and the parent is not single. The main effect of single parent status is also clear: both parent and teacher reports are more frequent if the parent is single. Further, children of single parents are more likely to be missing teacher reports. Figure 8 shows the MVPART tree, which splits only once, on single parent status. One reason for its brevity is that it ignores data from the 1073 children that do not have teacher responses.

6. Longitudinal data. Algorithm 3.1 is directly applicable to longitudinal data as long as they are observed on a fixed grid and the number of grid points is small. Since these conditions may be too restrictive, we show

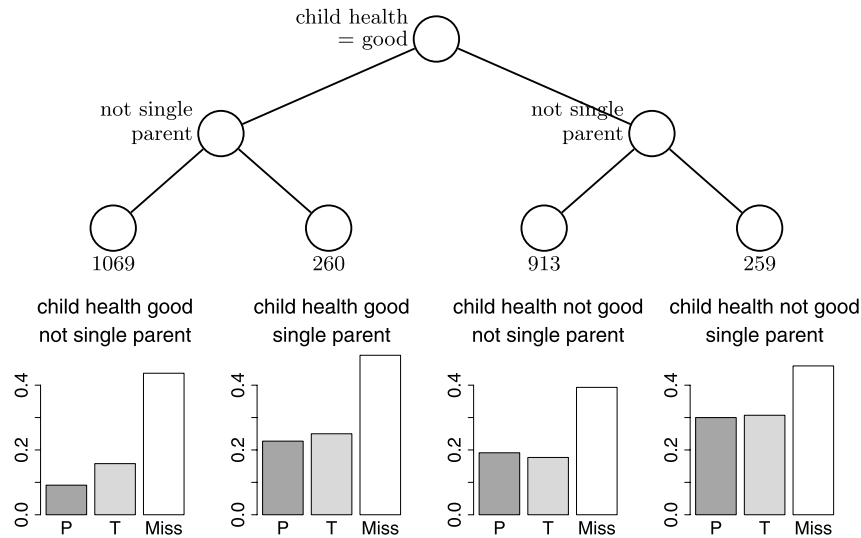

FIG. 7. *Multivariate GUIDE tree model for children’s mental health data. A case goes to the left branch at each intermediate node if and only if the condition on its left is satisfied. Sample sizes are given beneath the terminal nodes. The barplots below them give the proportions of parents (P) and teachers (T) reporting externalizing behavior and the proportions missing teacher responses.*

here how to modify the algorithm for broader applicability. To motivate and explain the changes, consider a longitudinal study on the hourly wage of 888 male high school dropouts (246 black, 204 Hispanic, 438 white), whose observation time points as well as their number (1–13) varied across individuals. [Singer and Willett \[\(2003\), Section 5.2.1\]](#) fit a linear mixed effect (LME) model to the natural logarithm of hourly wage (`wage`) to these data. They choose the transformation partly to overcome the range restriction on

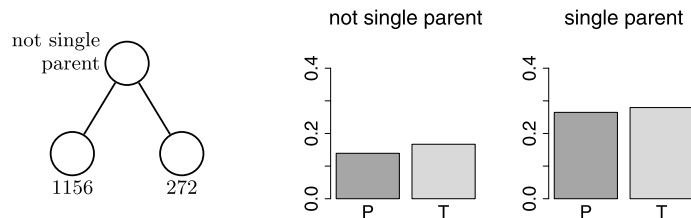

FIG. 8. *MVPART tree model for children’s mental health data. A case goes to the left branch at each intermediate node if and only if the condition on its left is satisfied. Sample sizes are given beneath the terminal nodes. The barplots give the proportions of parents (P) and teachers (T) reporting externalizing behavior and the proportions missing teacher responses in the terminal nodes. The model uses only the cases with nonmissing response values.*

TABLE 6
Fixed-effect estimates for linear mixed effect model (6.1) fitted to high school dropout data

	Value	Std. error	DF	t-value	p-value
(Intercept)	1.382	0.059	5511	23.43	0.000
hgc	0.038	0.006	884	5.94	0.000
exper	0.047	0.003	5511	14.57	0.000
black	0.006	0.025	884	0.25	0.804
hisp	-0.028	0.027	884	-1.03	0.302
exper \times black	-0.015	0.006	5511	-2.65	0.008
exper \times hisp	0.009	0.006	5511	1.51	0.131

hourly wage and partly to satisfy the linearity assumption. Their model is

$$\begin{aligned}
 E \log(\text{wage}) &= \beta_0 + \beta_1 \text{hgc} + \beta_2 \text{exper} + \beta_3 \text{black} + \beta_4 \text{hisp} \\
 (6.1) \quad &+ \beta_5 \text{exper} \times \text{black} + \beta_6 \text{exper} \times \text{hisp} \\
 &+ b_0 + b_1 \text{exper},
 \end{aligned}$$

where **hgc** is the highest grade completed, **exper** is the number of years (to the nearest day, after labor force entry), **black** = 1 if a subject is black and 0 otherwise, **hisp** = 1 if a subject is Hispanic and 0 otherwise, and b_0 and b_1 are subject random effects. The fixed-effect estimates in Table 6 show that **hgc** and **exper** are statistically significant, as is the interaction between **exper** and **black**. The main and interaction effects of **hisp** are not significant.

Let Y_{ij} denote the response of the i th subject at the j th observation time u_{ij} . To render Algorithm 3.1 applicable to varying numbers and values of u_{ij} , we first divide the range of the u_{ij} values into d disjoint intervals, U_1, U_2, \dots, U_d , of equal length, where d is user selectable. Then we replace steps (1) and (2) of the algorithm with these two steps:

(1) At each node, apply the lowest [Cleveland (1979)] method to the data points (u_{ij}, Y_{ij}) to estimate the mean of the Y_{ij} values with a smooth curve $S(u)$.

(2) Define $Z_k = 1$ for subject i if the number of observations with $Y_{ij} > S(u_{ij})$ is greater than or equal to the number with $Y_{ij} \leq S(u_{ij})$, for $u_{ij} \in U_k$, $k = 1, 2, \dots, d$. Otherwise, define $Z_k = -1$. (By this definition, $Z_k = -1$ if there are no observations in U_k .)

With these changes, we can fit a regression tree model to the wage data. Since our method is not limited by range restrictions on Y_{ij} or linearity assumptions, we fit the model to untransformed hourly wage, using **hgc** and **race** as split variables, **exper** as the time variable, and $d = 3$. Figure 9 shows the lowest curve for the data at the root node and a sample trajectory

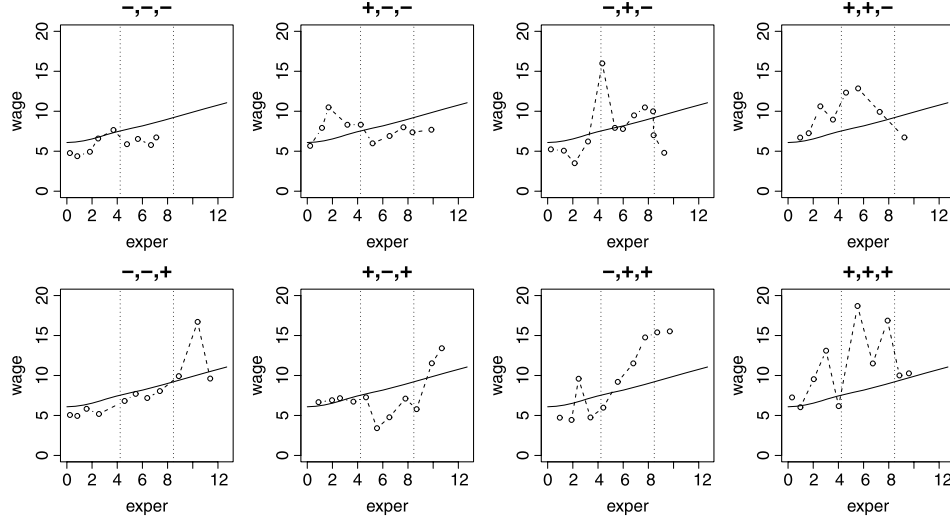

FIG. 9. Trajectories of eight high school individuals. The solid curve is the lowess fit to all the subjects. The signs in the plot titles are the signed values of (Z_1, Z_2, Z_3) , where $Z_k = 1$ if the number of observations above the lowess curve is greater than the number below the curve in the k th time interval, and $Z_k = -1$ otherwise.

for each of the eight possible values of (Z_1, Z_2, Z_3) . Figure 10 gives the pruned tree, which has five terminal nodes. The first split is on `race`; if `race = white`, the node is further split on `hgc ≤ 9`. Lowess curves for the five terminal nodes are drawn below the tree. Contrary to the finding in Singer and Willett [(2003), page 149] that the trajectories of Hispanic and White subjects cannot be distinguished statistically, we see that Hispanics tend to have slightly lower hourly wage rates than Whites. In addition, the slope of the mean trajectory for Blacks with `hgc ≤ 9` appears to decrease after 4 years of experience, contradicting the exponential trend implied by the logarithmic transformation of `wage` in the linear mixed model.

7. GEE and LME versus GUIDE. A simulation experiment was performed to compare the prediction accuracies of GEE, GUIDE and LME. Two simulation models are used, each with five independent predictor variables, X_1, X_2, \dots, X_5 , uniformly distributed on $(-1, 1)$. Longitudinal observations are drawn at d equally spaced time points, $u = 1, 2, \dots, d$, with $d = 10$. The models are

$$(7.1) \quad Y_u = 1 + X_1 + X_2 + 2X_1X_2 + 0.5u + b_0 + b_1u + \varepsilon_u$$

and

$$(7.2) \quad Y_u = 2.5I(X_1 \leq 0) + 0.5u + b_0 + b_1u + \varepsilon_u,$$

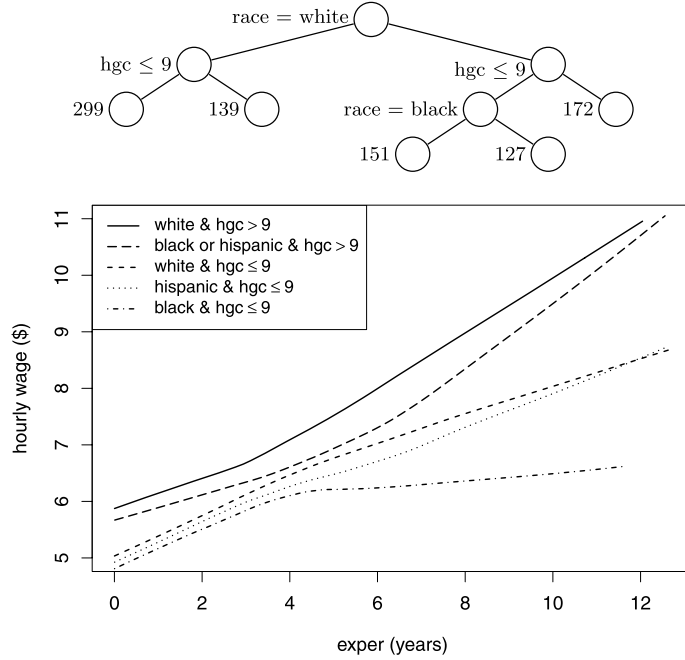

FIG. 10. Multivariate GUIDE tree for high school dropout data on top; lowess-smoothed estimates of mean hourly wage by leaf node on bottom. At an intermediate node, a case goes to the left branch if and only if the given condition is satisfied; sample sizes are given beneath the terminal nodes.

where $b_0 \sim N(0, 0.5^2)$ and $b_1 \sim N(0, 0.25^2)$ are random effects, ε_u is standard normal, and all are mutually independent. The fitted model in both cases is

$$Y_u = \beta_0 + \beta_1 X_1 + \beta_2 X_2 + \cdots + \beta_5 X_5 + \beta_6 u + b_0 + b_1 u + \varepsilon_u$$

and the parameters, $\beta_0, \beta_1, \dots, \beta_6$, are estimated using the R packages *lme4* [Bates (2011)] and *geepack* [Yan, Højsgaard and Halekoh (2012)] for LME and GEE, respectively, with GEE employing a compound symmetry correlation structure. Model (7.1) is almost perfect for LME and GEE except for the interaction term and model (7.2) is almost perfect for GUIDE except for the terms linear in u .

For each simulation trial, a training set of two hundred longitudinal data series are generated from the appropriate simulation model. Estimates $\hat{f}(u, x_1, x_2, \dots, x_5)$ of the conditional mean $E(y_u | x_1, x_2, \dots, x_5)$ are obtained for each method on a uniform grid of $m = 6^5 = 7776$ points $(x_{i1}, x_{i2}, \dots, x_{i5}) \in (-1, 1)^5$ and the mean squared error

$$\text{MSE} = (dm)^{-1} \sum_{i=1}^m \sum_{u=1}^d \{\hat{f}(u, x_{i1}, x_{i2}, \dots, x_{i5}) - E(y_u | x_{i1}, x_{i2}, \dots, x_{i5})\}^2$$

TABLE 7
Estimated mean squared errors for LME, GEE and GUIDE with standard errors

	LME	GEE	GUIDE
Model (7.1)	1.00 ± 0.01	1.12 ± 0.01	1.27 ± 0.03
Model (7.2)	0.49 ± 0.01	0.60 ± 0.01	0.12 ± 0.01

recorded. Table 7 shows the average values of the MSE and their estimated standard errors from 200 simulation trials. There is no uniformly best method. LME is best in model (7.1) and GUIDE is best in model (7.2). Because it makes fewer assumptions, GEE has a slightly higher MSE than LME in both models.

8. Time-varying covariates and multiple series. Our approach requires all predictor variables to be fixed with respect to time. An example where there is a time-varying covariate is the Mothers' Stress and Children's Morbidity study reported in Alexander and Markowitz (1986) and analyzed in Diggle et al. (2002), Chapter 12. In this study, the daily presence or absence of maternal stress and child illness in 167 mother-child pairs was observed over a four-week period. The children ranged in age from 18 months to 5 years. Time-independent variables, measured at the start of the study, are mother's marital and employment status (both binary), education level and health (both ordinal with 5 categories), child's race and sex (both binary), child's health (ordinal with 5 categories) and household size (3 or fewer vs. more than 3 people). Diggle et al. (2002) use GEE logistic regression models to answer the following questions:

- (1) Is there an association between mother's employment and child illness?
- (2) Is there an association between mother's employment and stress?
- (3) Does mother's stress cause child illness or vice versa?

For predicting child illness, their GEE model shows that day (since enrollment), mother's marital status, child's health and race, and household size are statistically significant, but mother's employment is not. Our method gives a trivial tree with no splits after pruning, suggesting that no variable other than day has predictive power. For predicting mother's stress, their GEE model finds that day, mother's health, marital status and education, child's health, household size and the interaction between day and employment are significant. Our pruned tree has two terminal nodes, separating children that have very good health from those that do not. Figure 11 shows plots of the observed and lowess-smoothed mean frequencies of mother's stress, grouped by mother's employment status (left) and by child health as found by our tree model (right). The curves defined by employment cross

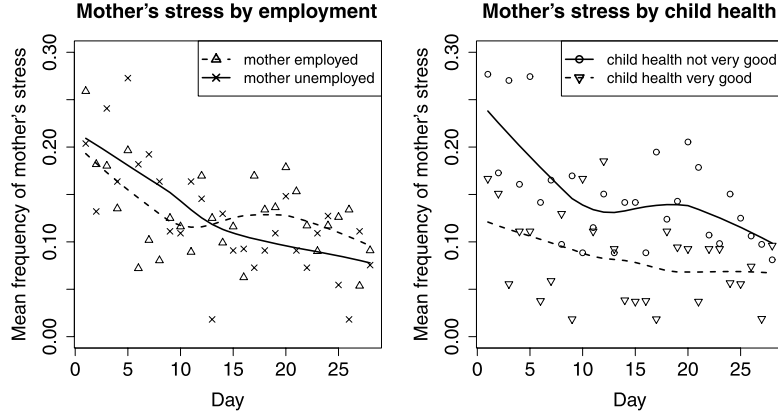

FIG. 11. Average and smoothed frequencies of mother's stress by employment and child health.

over, lending support to the significance of the day-employment interaction effect found in the GEE model. The large separation between the two curves defined by child's health, on the other hand, indicates a large main effect.

On the third question of whether mother's stress causes child's illness or vice versa, Diggle et al. (2002) find, by fitting GEE models with lagged values of stress and illness as additional predictors, that the answer can be both. They conclude that there is evidence of feedback, where a covariate both influences and is influenced by a response. Instead of trying to determine which is the cause and which is the effect, we fit a regression tree model that simultaneously predicts mother's stress and child's illness by concatenating the two series into one long series with 56 observations. Choosing $d = 8$ (four intervals each for stress and illness), we obtain the results in Figure 12, which shows that mother's health and household size are the most important predictors. The plots below the tree confirm that mother's stress (dashed curves) and child's illness (solid curves) vary together. More interesting is that the two responses do not decrease monotonically with time. In particular, when mother's health is fair or worse and household size is three or less, the frequencies of mother's stress and child's illness tend to decrease together in the first half and increase together in the second half of the study period. This behavior is ruled out by the GEE model of Diggle et al. (2002). We are thus reminded that the statistical significance of the terms in a parametric model always depends on the model being correctly specified. If the specification is correct, the parametric approach will often possess greater sensitivity; otherwise important features of the data may be undetected.

9. Asymptotic consistency. We give some conditions for asymptotic consistency of the regression function estimates, as the training sample size increases, for multiresponse and longitudinal data models. The conditions

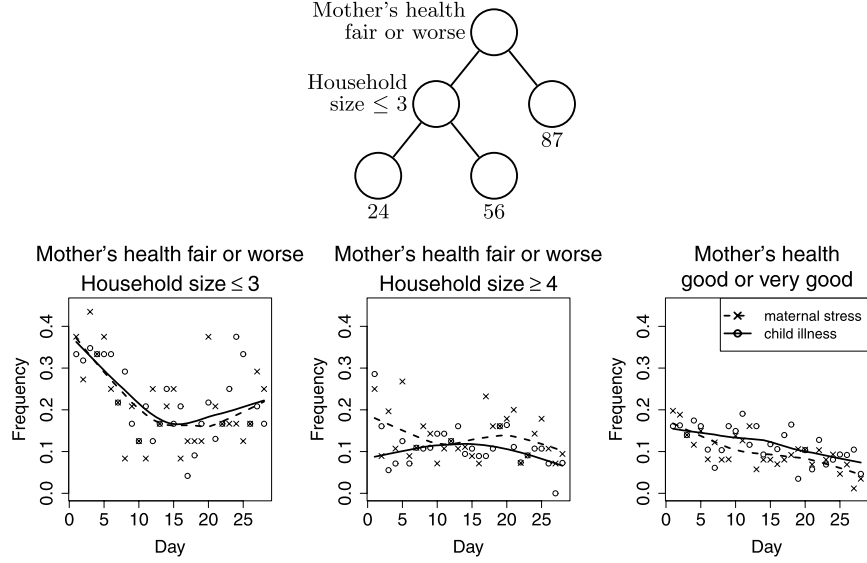

FIG. 12. Multivariate GUIDE model for simultaneously predicting maternal stress and child health. A case goes to the left branch at each intermediate node if and only if the condition on its left is satisfied. The number beneath each terminal node is the sample size. The plots below the tree show the observed and smoothed daily mean frequencies of mother's stress and child's illness.

generalize those for univariate responses in Chaudhuri et al. (1994, 1995), Chaudhuri and Loh (2002) and Kim et al. (2007). We assume that there is a true regression function $g(\mathbf{x}, u)$, where \mathbf{x} is a vector of predictor variable values in a compact set, u is the observation time in a compact set U , and $\sup_{u, \mathbf{x}} |g(\mathbf{x}, u)| < \infty$. The training data consist of vectors $(y_{ij}, \mathbf{x}_i, u_{ij})$, $i = 1, \dots, M$ and $j = 1, \dots, m_i$, where y_{ij} is the observed response of subject i at time $u_{ij} \in U$, \mathbf{x}_i is the corresponding \mathbf{x} value, and $y_{ij} = g(\mathbf{x}_i, u_{ij}) + \varepsilon_{ij}$. The ε_{ij} 's are assumed to have zero mean, constant (finite) variance and to be independent of u_{ij} for all i and j . This setup applies to the multiresponse model as well, because it can be treated as a longitudinal model with fixed time points. Let $N = \sum_{i=1}^M m_i$ denote the total number of data points and let T_N denote the collection of terminal nodes of a regression tree obtained by partitioning the data by its \mathbf{x} values. Given (\mathbf{x}^*, u^*) , let t^* denote the terminal node containing \mathbf{x}^* .

9.1. *Multiresponse and longitudinal data with fixed time points.* Assume that U is a finite set. Let $\delta(T_N) = \min_{t \in T_N, u \in U} |\{(i, j) : \mathbf{x}_i \in t, u_{ij} = u\}|$ denote the smallest number of data points per time point across all terminal nodes. Define $I_N^* = \{(i, j) : \mathbf{x}_i \in t^*, u_{ij} = u^*\}$ and let k_N denote the number of elements in I_N^* . Assume further that the following conditions hold:

- (A1) The ε_{ij} are mutually independent for all i and j .

(A2) $\delta(T_N) \xrightarrow{P} \infty$ as $N \rightarrow \infty$.

(A3) For each $u \in U$, $\sup_{t \in T_N} \sup_{\mathbf{x}_1, \mathbf{x}_2 \in t} |g(\mathbf{x}_1, u) - g(\mathbf{x}_2, u)| \xrightarrow{P} 0$ as $N \rightarrow \infty$.

Condition (A2) ensures that there are sufficient observations in each terminal node for consistent estimation. Condition (A3) requires the function to be sufficiently smooth; it implies that for each $u \in U$, $g(\mathbf{x}, u)$ is uniformly continuous w.r.t. \mathbf{x} in each $t \in T_N$. In other words, (A3) assumes that the partitioning algorithm is capable of choosing the right splits so that within each node, the mean response curves are close to each other.

The regression estimate of $g(\mathbf{x}^*, u^*)$ is

$$\begin{aligned} \hat{g}(\mathbf{x}^*, u^*) &= k_N^{-1} \sum_{(i,j) \in I_N^*} y_{ij} \\ &= k_N^{-1} \sum_{(i,j) \in I_N^*} \{g(\mathbf{x}_i, u_{ij}) + \varepsilon_{ij}\} \\ &= k_N^{-1} \sum_{(i,j) \in I_N^*} \{g(\mathbf{x}_i, u^*) + \varepsilon_{ij}\} \end{aligned}$$

by definition of I_N^* . Therefore,

$$|\hat{g}(\mathbf{x}^*, u^*) - g(\mathbf{x}^*, u^*)| \leq k_N^{-1} \left| \sum_{(i,j) \in I_N^*} \{g(\mathbf{x}_i, u^*) - g(\mathbf{x}^*, u^*)\} \right| + k_N^{-1} \left| \sum_{(i,j) \in I_N^*} \varepsilon_{ij} \right|.$$

Condition (A3) implies that the first term on the right-hand side of the inequality converges to zero in probability. Condition (A2) implies that $k_N \xrightarrow{P} \infty$, which together with the independence and constant variance assumptions on ε_i imply that the second term converges to zero as well. Therefore, $\hat{g}(\mathbf{x}^*, u^*) \xrightarrow{P} g(\mathbf{x}^*, u^*)$ as $N \rightarrow \infty$ at every (\mathbf{x}^*, u^*) .

9.2. Longitudinal data with random time points. Suppose now that U is a compact interval and that the u_{ij} 's are random. Let $K(u) \geq 0$ be a kernel function with bandwidth h_N . The estimate of $g(\mathbf{x}, u)$ at (\mathbf{x}^*, u^*) is

$$\hat{g}(\mathbf{x}^*, u^*) = \frac{\sum_{\mathbf{x}_i \in t^*} \sum_{j=1}^{m_i} K\{h_N^{-1}(u_{ij} - u^*)\} y_{ij}}{\sum_{\mathbf{x}_i \in t^*} \sum_{j=1}^{m_i} K\{h_N^{-1}(u_{ij} - u^*)\}}.$$

Let n_N denote the smallest number of data points in the terminal nodes of the tree. Assume that the following conditions hold:

(B1) The u_{ij} values are independent and identically distributed and their density function $f(u)$ is positive everywhere and does not depend on the \mathbf{x}_i values, for all i and j .

(B2) $\sup_{t \in T_N} \sup\{|g(\mathbf{x}_1, u) - g(\mathbf{x}_2, u)| : u \in U, \mathbf{x}_1, \mathbf{x}_2 \in t\} \xrightarrow{P} 0$ as $N \rightarrow \infty$.

- (B3) The density function of u_{ij} is positive everywhere in U and:
- (i) $\int |K(u)| du < \infty$,
 - (ii) $\lim_{|u| \rightarrow \infty} uK(u) = 0$,
 - (iii) $n_N \xrightarrow{P} \infty$, $h_N \xrightarrow{P} 0$ and $n_N h_N \xrightarrow{P} \infty$ as $N \rightarrow \infty$.
- (B4) The error vectors $\varepsilon_i = (\varepsilon_{i1}, \dots, \varepsilon_{im_i})'$ are independent between subjects. For each i , ε_i has a covariance matrix with elements σ_{ijk} such that $\sigma_{ijk} = \sigma^2$ for $j = k$ and $\max_i m_i^{-1} \sum_{j \neq k} \sigma_{ijk} \leq A$ for some positive constant A .

Condition (B1) ensures that the value of u^* is not constrained by the value of \mathbf{x}^* . Condition (B2) is a stronger version of (A3) and condition (B3) is a standard requirement for consistency of kernel estimates. Condition (B4) ensures that the correlations between the random errors are small.

Write

$$\begin{aligned}
& \hat{g}(\mathbf{x}^*, u^*) - g(\mathbf{x}^*, u^*) \\
&= \frac{\sum_{\mathbf{x}_i \in t^*} \sum_{j=1}^{m_i} K\{h_N^{-1}(u_{ij} - u^*)\} \{y_{ij} - g(\mathbf{x}^*, u^*)\}}{\sum_{\mathbf{x}_i \in t^*} \sum_{j=1}^{m_i} K\{h_N^{-1}(u_{ij} - u^*)\}} \\
&= \frac{\sum_{\mathbf{x}_i \in t^*} \sum_{j=1}^{m_i} K\{h_N^{-1}(u_{ij} - u^*)\} \{g(\mathbf{x}_i, u_{ij}) + \varepsilon_{ij} - g(\mathbf{x}^*, u^*)\}}{\sum_{\mathbf{x}_i \in t^*} \sum_{j=1}^{m_i} K\{h_N^{-1}(u_{ij} - u^*)\}} \\
&= \frac{\sum_{\mathbf{x}_i \in t^*} \sum_{j=1}^{m_i} K\{h_N^{-1}(u_{ij} - u^*)\} \{g(\mathbf{x}^*, u_{ij}) - g(\mathbf{x}^*, u^*)\}}{\sum_{\mathbf{x}_i \in t^*} \sum_{j=1}^{m_i} K\{h_N^{-1}(u_{ij} - u^*)\}} \\
&\quad + \frac{\sum_{\mathbf{x}_i \in t^*} \sum_{j=1}^{m_i} K\{h_N^{-1}(u_{ij} - u^*)\} \{g(\mathbf{x}_i, u_{ij}) - g(\mathbf{x}^*, u_{ij})\}}{\sum_{\mathbf{x}_i \in t^*} \sum_{j=1}^{m_i} K\{h_N^{-1}(u_{ij} - u^*)\}} \\
&\quad + \frac{\sum_{\mathbf{x}_i \in t^*} \sum_{j=1}^{m_i} K\{h_N^{-1}(u_{ij} - u^*)\} \varepsilon_{ij}}{\sum_{\mathbf{x}_i \in t^*} \sum_{j=1}^{m_i} K\{h_N^{-1}(u_{ij} - u^*)\}} \\
&= J_1 + J_2 + J_3 \quad (\text{say}).
\end{aligned}$$

Define the local polynomial estimator (which depends on u_{ij} 's but not on the values of $\mathbf{x}_1, \dots, \mathbf{x}_M$)

$$\bar{g}(\mathbf{x}^*, u^*) = \frac{\sum_{\mathbf{x}_i \in t^*} \sum_{j=1}^{m_i} K\{h_N^{-1}(u_{ij} - u^*)\} g(\mathbf{x}^*, u_{ij})}{\sum_{\mathbf{x}_i \in t^*} \sum_{j=1}^{m_i} K\{h_N^{-1}(u_{ij} - u^*)\}}.$$

Then $J_1 = \bar{g}(\mathbf{x}^*, u^*) - g(\mathbf{x}^*, u^*) \xrightarrow{P} 0$ by condition (B3) [Härdle (1990), page 29] and $J_2 \xrightarrow{P} 0$ by condition (B2).

Note that $(Nh_N)^{-1} \sum_{\mathbf{x}_i \in t^*} \sum_{j=1}^{m_i} K\{h_N^{-1}(u_{ij} - u^*)\} \xrightarrow{P} f(u^*) \int K(z) dz$, where $f(u)$ is the density function of the u_{ij} . Conditions (B1) and (B4)

imply

$$\begin{aligned}
& E \left[(Nh_N)^{-1} \sum_{\mathbf{x}_i \in t^*} \sum_{j=1}^{m_i} K\{h_N^{-1}(u_{ij} - u^*)\} \varepsilon_{ij} \right]^2 \\
&= (Nh_N)^{-2} \sum_{\mathbf{x}_i \in t^*} \sigma^2 m_i E[K^2\{h_N^{-1}(u_{i1} - u^*)\}] \\
&\quad + (Nh_N)^{-2} \sum_{\mathbf{x}_i \in t^*} [EK\{h_N^{-1}(u_{i1} - u^*)\}]^2 \sum_{j \neq k} \sigma_{ijk} \\
&\leq \sigma^2 N^{-1} h_N^{-2} E[K^2\{h_N^{-1}(u_{i1} - u^*)\}] \\
&\quad + A(Nh_N)^{-2} [EK\{h_N^{-1}(u_{i1} - u^*)\}]^2 \sum_{\mathbf{x}_i \in t^*} m_i \\
&= \sigma^2 (Nh_N)^{-1} f(u^*) \int K^2(z) dz + AN^{-1} \left\{ \int K(z) dz \right\}^2 + o(1) \\
&\rightarrow 0.
\end{aligned}$$

It follows that $J_3 \xrightarrow{P} 0$ and, hence, $\hat{g}(\mathbf{x}^*, u^*) \xrightarrow{P} g(\mathbf{x}^*, u^*)$ as $N \rightarrow \infty$.

10. Concluding remarks. Previous algorithms for fitting regression trees to multiresponse and longitudinal data typically follow the CART approach, with various likelihood-based node impurity functions. Although straightforward, this strategy has two disadvantages: the algorithms inherit the variable selection biases of CART and are constrained by computational difficulties due to maximum likelihood and covariance estimation at every node of the tree.

To avoid these problems, we have introduced an algorithm based on the univariate GUIDE method that does not have selection bias and does not require maximization of likelihoods or estimation of covariance matrices. Unbiasedness is obtained by selecting the split variable with contingency table chi-squared tests, where the columns of each table are defined by the patterns of the data trajectories relative to the mean trajectory and the rows are defined by the values of a predictor variable. The mean trajectory is obtained by applying a nonparametric smoother to the data in the node. For split set selection and for tree pruning, the node impurity is defined as the total, over the number of response variables, of the sum of (optionally normalized) squared errors for each response variable. Correlations among longitudinal response values are implicitly accounted for by the smoothing and the residual trajectory patterns.

Because no assumptions are made about the structure of the model in each node, it is quite possible that our method is less powerful than other tree methods in situations where the assumptions required by the latter are

satisfied. (These assumptions, such as autoregressive models, are hard to justify because they need to be satisfied within random partitions of the data.) What we lose in sensitivity, though, we expect to gain in robustness. Besides, the simplicity of our smoothing and means-based approach lends itself more easily to asymptotic analysis. Further, as is evident from the longitudinal data examples, plots of the smoothed mean trajectories in the terminal nodes provide a visual summary of the data that is more realistic than the necessarily more stylized summaries of parametric or semi-parametric models.

Our approach should not be regarded, however, as a substitute for parametric and semi-parametric methods such as GEE and LME for longitudinal data. Because the latter methods assume a parametric model for the mean response function, they permit parametric statistical inference, such as significance tests and confidence intervals, to be performed. No such inference is possible for regression tree models, as there are no model parameters in the traditional sense. Regression tree models are simply approximations to the unknown response functions, whatever they may be, and are meant for descriptive and prediction purposes. Although GEE and LME models can be used for prediction too, their constructions are based on significance tests, unlike tree models which are focused on prediction error. In applications where the sample size and number of predictor variables are small and the model is correctly specified, GEE and LME will always be more powerful than tree methods, due to the extra information provided by the parametric model. But if the sample size or the number of predictor variables is large, it can be challenging to select the right parametric model. It is in such situations that a regression tree model can be quite useful because it provides a relatively simple and interpretable description of the data. The fitted tree model can serve a variable selection purpose as well, by identifying a subset of predictor variables for subsequent parametric modeling, if desired.

The proposed method is implemented in the GUIDE software which can be obtained from www.stat.wisc.edu/~loh/guide.html.

Acknowledgments. We are grateful to Editor Susan Paddock, an anonymous Associate Editor and two referees for comments and suggestions that led to improvements in the article. CART® is a registered trademark of California Statistical Software, Inc.

REFERENCES

- ABDOLELL, M., LEBLANC, M., STEPHENS, D. and HARRISON, R. V. (2002). Binary partitioning for continuous longitudinal data: Categorizing a prognostic variable. *Stat. Med.* **21** 3395–3409.
- ALEXANDER, C. S. and MARKOWITZ, R. (1986). Maternal employment and use of pediatric clinic services. *Med. Care* **24** 134–147.
- ASUNCION, A. and NEWMAN, D. J. (2007). UCI Machine Learning Repository. Available at <http://www.ics.uci.edu/~mllearn/MLRepository.html>.

- BATES, D. (2011). Linear mixed-effects models using S4 classes. R package version 0.999375-42.
- BREIMAN, L., FRIEDMAN, J. H., OLSHEN, R. A. and STONE, C. J. (1984). *Classification and Regression Trees*. Wadsworth, Belmont, CA.
- CHAUDHURI, P. and LOH, W.-Y. (2002). Nonparametric estimation of conditional quantiles using quantile regression trees. *Bernoulli* **8** 561–576. [MR1935647](#)
- CHAUDHURI, P., HUANG, M. C., LOH, W. Y. and YAO, R. (1994). Piecewise-polynomial regression trees. *Statist. Sinica* **4** 143–167.
- CHAUDHURI, P., LO, W. D., LOH, W.-Y. and YANG, C. C. (1995). Generalized regression trees. *Statist. Sinica* **5** 641–666. [MR1347613](#)
- CLEVELAND, W. S. (1979). Robust locally weighted regression and smoothing scatterplots. *J. Amer. Statist. Assoc.* **74** 829–836. [MR0556476](#)
- DE'ATH, G. (2002). Multivariate regression trees: A new technique for modeling species-environment relationships. *Ecology* **83** 1105–1117.
- DE'ATH, G. (2012). MVPART: Multivariate partitioning. R package version 1.6-0.
- DIGGLE, P. J., HEAGERTY, P. J., LIANG, K.-Y. and ZEGER, S. L. (2002). *Analysis of Longitudinal Data*, 2nd ed. *Oxford Statistical Science Series* **25**. Oxford Univ. Press, Oxford. [MR2049007](#)
- FITZMAURICE, G. M., LAIRD, N. M. and WARE, J. H. (2004). *Applied Longitudinal Analysis*. Wiley, Hoboken, NJ. [MR2063401](#)
- HÄRDLE, W. (1990). *Applied Nonparametric Regression*. *Econometric Society Monographs* **19**. Cambridge Univ. Press, Cambridge. [MR1161622](#)
- HOTHORN, T., HORNIK, K. and ZEILEIS, A. (2006). Unbiased recursive partitioning: A conditional inference framework. *J. Comput. Graph. Statist.* **15** 651–674. [MR2291267](#)
- HSIAO, W.-C. and SHIH, Y.-S. (2007). Splitting variable selection for multivariate regression trees. *Statist. Probab. Lett.* **77** 265–271. [MR2339030](#)
- KIM, H., LOH, W. Y., SHIH, Y. S. and CHAUDHURI, P. (2007). Visualizable and interpretable regression models with good prediction power. *IEEE Transactions* **39** 565–579.
- LARSEN, D. R. and SPECKMAN, P. L. (2004). Multivariate regression trees for analysis of abundance data. *Biometrics* **60** 543–549. [MR2067013](#)
- LEE, S. K. (2005). On generalized multivariate decision tree by using GEE. *Comput. Statist. Data Anal.* **49** 1105–1119. [MR2143060](#)
- LOH, W.-Y. (2002). Regression trees with unbiased variable selection and interaction detection. *Statist. Sinica* **12** 361–386. [MR1902715](#)
- LOH, W.-Y. (2009). Improving the precision of classification trees. *Ann. Appl. Stat.* **3** 1710–1737. [MR2752155](#)
- LOH, W.-Y. and SHIH, Y.-S. (1997). Split selection methods for classification trees. *Statist. Sinica* **7** 815–840. [MR1488644](#)
- SEGAL, M. R. (1992). Tree structured methods for longitudinal data. *J. Amer. Statist. Assoc.* **87** 407–418.
- SHIH, Y. S. (2004). A note on split selection bias in classification trees. *Comput. Statist. Data Anal.* **45** 457–466. [MR2050250](#)
- SINGER, J. D. and WILLETT, J. B. (2003). *Applied Longitudinal Data Analysis*. Oxford Univ. Press, New York.
- STROBL, C., BOULESTEIX, A.-L. and AUGUSTIN, T. (2007). Unbiased split selection for classification trees based on the Gini index. *Comput. Statist. Data Anal.* **52** 483–501. [MR2409997](#)
- YAN, J., HØJSGAARD and HALEKOH, U. (2012). Generalized estimation equation solver. R package version 1.1-6.

- YEH, I. C. (2007). Modeling slump flow of concrete using second-order regressions and artificial neural networks. *Cement and Concrete Composites* **29** 474–480.
- YU, Y. and LAMBERT, D. (1999). Fitting trees to functional data, with an application to time-of-day patterns. *J. Comput. Graph. Statist.* **8** 749–762.
- ZHANG, H. (1998). Classification trees for multiple binary responses. *J. Amer. Statist. Assoc.* **93** 180–193.
- ZHANG, H. and YE, Y. (2008). A tree-based method for modeling a multivariate ordinal response. *Stat. Interface* **1** 169–178. [MR2425353](#)

DEPARTMENT OF STATISTICS
UNIVERSITY OF WISCONSIN–MADISON
1300 UNIVERSITY AVENUE
MADISON, WISCONSIN 53706
USA
E-MAIL: loh@stat.wisc.edu
URL: <http://www.stat.wisc.edu/~loh>

SANOFI-AVENTIS U.S. LLC
300 3RD STREET
CAMBRIDGE, MASSACHUSETTS 02139
USA
E-MAIL: Wei.Zheng2@sanofi-aventis.com