

Traditional and novel approaches to palaeoclimate modelling

Michel Crucifix

Earth and Life Institute, George Lemaitre Centre for Earth and Climate Research, Université catholique de Louvain, Louvain-la-Neuve, Belgium. E-mail: michel.crucifix@uclouvain.be

5 Abstract

Palaeoclimate archives contain information on climate variability, trends and mechanisms. Models are developed to explain observations and predict the response of the climate system to perturbations, in particular perturbations associated with the anthropogenic influence. Here, we review three classical frameworks of climate modelling: conceptual, simulator-based
10 (including general circulation models and Earth system models of intermediate complexity), and statistical. The conceptual framework aims at a parsimonious representation of a given climate phenomenon; the simulator-based framework connects physical and biogeochemical principles with phenomena at different spatial and temporal scales; and statistical modelling is a framework for inference from observations, given hypotheses on systematic and
15 random effects. Recently, solutions have been proposed in the literature to combine these frameworks, and new concepts have emerged: the emulator (a statistical, computing efficient surrogate for the simulator) and the discrepancy, which is a statistical representation of the difference between the simulator and the real phenomenon. These concepts are explained, with references to implementations for both time-slices and dynamical applications.

20 highlights:

1. Clarify three palaeoclimate modelling frameworks
2. Different definitions and applications of the conceptual models
3. Comment on usage and interest of numerical simulators
4. Show how statistical methods apply to process-based modelling
- 25 5. Review the current use of emulators and discrepancy in palaeoclimate modelling.

Keywords: modelling, conceptual, general circulation models, time-space process, inference, Bayesian palaeoclimate reconstructions

1. Introduction

Palaeoclimatology, as any natural science, depends on observations to generate scientific activity. Questions about ice ages, Dansgaard-Oeschger events, fluctuations in CO₂ atmospheric concentration, would not have been raised if these phenomena had not been observed in the first place. Scientists attempt to model these phenomena in order to explain them, to predict them, raise new questions and suggest additional experiments.

In climate science modellers are confronted to a dilemma about model complexity. Although this dilemma is often presented in terms of a compromise about computing power, there is a more fundamental dichotomy.

On the one hand, the explanatory power of a model tends to be better accepted if the number of *ad hoc* hypotheses is as small as possible, even if this comes at the cost of not reproducing all the details of the phenomenon. This is the celebrated Ockham's razor principle, that encourages us to explain as much as possible with as little as possible. Consistent with this line of reasoning, [Held \(2005\)](#) recommends systematic research on simple hydrodynamical models such as the dry baroclinic atmosphere. As shall be reviewed here, even simpler systems, based on a small number of equations, have non-trivial properties which are helpful to interpret glacial-interglacial cycles and abrupt events. Furthermore, small mathematical models are easy to communicate so that the results can be well reproduced by peer scientists on the basis of information available in the publication.

On the other hand, climate scientists have developed large numerical models, which encapsulate available knowledge on a huge variety of climate processes at different spatial and temporal scales, ranging from cloud formation to sediment kinematics. Here we will term call these models: simulators. Current climate simulators are impressively successful at reproducing many features of our climate system ¹, and the idea is to use them as experimental substitutes to real climate system. However, running simulators is a technically involved operation, and it is difficult if not impossible to fully appreciate the consequences of all the technical choices and physical hypotheses that they contain ([Winsberg, 1999](#)).

A number of concepts and theories may help us to articulate these different modelling frameworks. The starting point is that mathematical models generate uncertain information about the climate system, and the purpose of any climate modeler is to connect this information with the real world. The branch of mathematics concerned with inference in presence of uncertain information is nothing but statistics.

The purpose of the present article is to review the traditional approaches to palaeoclimate modelling, and, then, to show how statistics may help us to progress in the different problems involved in the prediction and explanation of (palaeo-)climate phenomena. The diagram on [Figure 1](#) may be used as a road map. The different colors constitute different frameworks of palaeoclimate modelling: conceptual models, simulators (which includes general circulation models) and statistical models. They are connected to a number of concepts, which are detailed in [Section 2](#). The light gray nodes represent traditional connections between the modelling frameworks, while the dark grey ones refer to more recent concepts, introduced and commented on in [Section 3](#).

¹a list of references is available at http://www-pcmdi.llnl.gov/ipcc/subproject_publications.php.

2. Traditional frameworks of palaeoclimate modelling

2.1. Conceptual models

2.1.1. Definition and construction strategy

In general, a ‘conceptual model’ is a drastically simplified representation of a complex process. However, even in this context, the word ‘model’ is used diversely in the literature ².

It may be a schematic description of the mechanisms involved in a complex process, often supported by a visual diagram. The ‘SPECMAP’ model (*Imbrie et al., 1992, 1993*) is a description of the chain of responses of the different components of the Earth climate system involved in glacial-interglacial cycles (Figure 2). Likewise, the results of sensitivity experiments with general circulation models are often summarised in the form of a diagram. For example, *Zhao et al. (2005)* summarise a mechanistic interpretation of the effect of the ocean on the African and Indian monsoons with two diagrams outlining the roles of trade winds, evaporation and stratification.

The word ‘model’ may also refer to a perceptual analogy. For example, the thermohaline circulation was depicted as a ‘conveyor belt’ (*Broecker, 1991*) ³, a ‘leaky funnel’ (*Mouchet and Deleersnijder, 2008*) and, before this, it was compared to a device that can be set up in the laboratory with two vessels and a system of stirrers, porous walls and capillary pipes materialising the effects of mixing, diffusion and advection (*Stommel, 1961*) (Figure 3). The different perceptual analogies convey different impressions about the roles of advection and diffusion in the ocean circulation physics. Electronic circuits are another basis for perceptual analogies. *Hansen et al. (1984)* introduced the concept of “gain”, originally used in electronics, to quantify the effects of “feedbacks” of climate system components to a radiative perturbation. This electronic analogy was made more explicit by *Schwartz (2011)*, and it is further discussed later in this section (Figure 4). More abstract perceptual analogies have been suggested, in particular the relaxation model, in which it is assumed that the system is being relaxed (like a spring) to various states determined by the forcing and the history of the system. This analogy has been much used by Paillard (*Paillard and Labeyrie, 1994; Paillard, 1998, 2001; Paillard and Parrenin, 2004*).

Finally, ‘conceptual model’ may refer to a simple system of mathematical equations. There are different strategies exist to determine these equations:

²cf. also *Winsberg (1999)* for more discussion on the meaning given to the word ‘model’ in the context of simulation

³The conveyor belt logo was introduced in the November issue of the *Natural History* magazine and the (*Broecker, 1991*) reference quoted here is a discussion of the relevance and limit of this analogy.

Figure 1 (*following page*): Conceptual representation of the three main frameworks of palaeoclimate modelling and bridging concepts. The main frameworks are represented by the three main nodes: simulators in red, conceptual models in blue and statistical models in green. Light grey nodes represent traditional connections between the main modelling frameworks, while the dark gray ones indicate concepts more recently introduced in the palaeoclimate modelling literature. Numbers in nodes refer to section numbers of the present article.

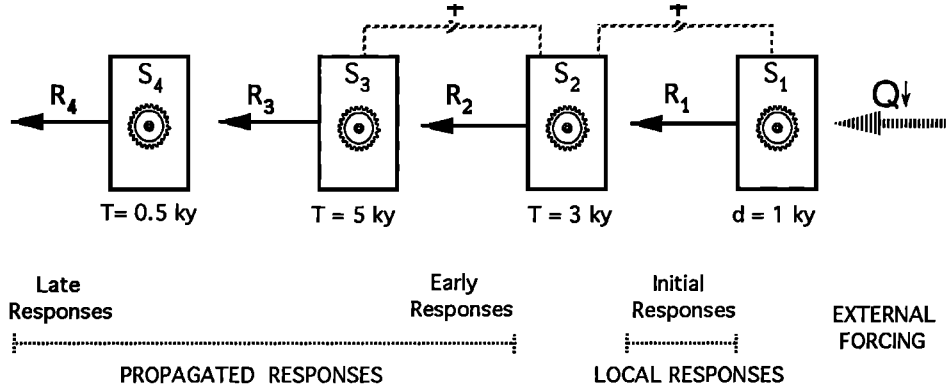

Figure 2: The [Imbrie et al. \(1992\)](#) conceptual model of the linear climate system response to the astronomical forcings associated to precession and obliquity. The model describes a sequence of initial, early and late responses noted S_1 to S_4 , to the astronomical forcing (Q), each response lagging the previous one by 0.5 to 4 ky (1 ky=1,000 years). Reproduced with permission from American Geophysical Union.

- They may be written to translate a perceptual analogy in order to analyse and discuss its consequences on the system dynamics. For example, the [Stommel \(1961\)](#) model can be expressed as two equations constrained by the laws of conservation of tracers combined with a parameterisation of the response of the inter-vessel flow to the density difference between the two vessels. One non-trivial consequence of this model is that it features two stable states, which have been interpreted as the on and off modes of the thermohaline circulation. Possible implications for the future of our climate are discussed in [Rahmstorf \(2000\)](#). Stommel’s model is the simplest example of a wider class of mathematical models called ‘box models’. The [Winton and Sarachik \(1993\)](#) model, for example, was used to study ocean internal oscillations involved in Dansgaard-Oeschger events ([Schulz et al., 2002](#)). The “Multi-box model” (MBM) ([Munhoven, 2007](#)) includes 10 boxes for the ocean and was used to study climate-ocean-sediment interactions over the latest glacial-interglacial cycle. The BICYCLE model, based in part on MBM, was used to interpret isotopic records ([Köhler et al., 2005](#)). It includes 6 ocean boxes plus a number of reservoirs for the terrestrial biosphere, rocks, sediments and atmosphere.
- Another strategy for developing mathematical conceptual models consists in starting from fluid dynamics equations and simplify them mathematically as much as possible, using a procedure called ‘truncation’. The technique is well-established ([Saltzman, 1962](#)) and it was applied to continental ice flow dynamics to study ice ages ([Oerlemans, 1980](#); [Ghil and Le Treut, 1981](#)) and Heinrich events ([Paillard, 1995](#)).
- Finally, the development of a conceptual model may be more heuristic, combining physical arguments, information obtained from sensitivity experiments with general circulation models and hypotheses on non-linear effects. This approach was champi-

oned by [Saltzman \(2001\)](#).

Mathematical models may then be distinguished according to their mathematical properties, in particular, whether they are linear or non-linear, and whether they are deterministic or stochastic. This aspect is now further developed.

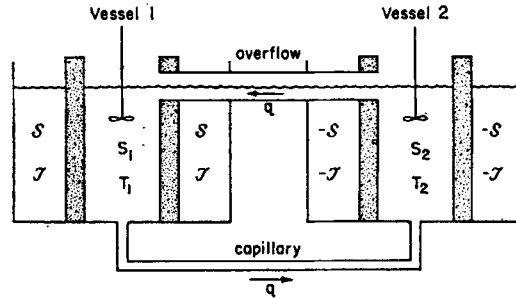

Figure 3: Mechanical representation of the classical three-box [Stommel \(1961\)](#) model, with an explicit representation of diffusive phenomena (through porous walls) and advective flows (through the capillary pipe). The Stommel model is a prototype of more complex models used nowadays (see text). Reproduced from the original publication.

2.1.2. Linear models

Consider an electronic circuit with resistors and a capacitor (Figure 4). Resistors dissipate current proportionally to the difference in voltage to which it is connected (the coefficient is the *resistance*); and the voltage across the capacitor increases proportionally to the charge being stored on it (the coefficient is the *capacity*). The system is said *linear* if the resistances and capacitance are constant.

In an analogy with the climate system, the current may be viewed as the input radiation (in a global warming experiment) or the net accumulation of snow on the ice sheets (in a Milankovitch forcing experiment). The capacitor accumulates charge over time. At the Milankovitch scale, ice sheets play this role, since they accumulate snow mass imbalance over several thousands of years. The growth of ice sheets causes a tension (voltage) on the system, and the role of resistors is to dissipate this tension with a discharge current, so that tension does not grow to infinity. At Milankovitch time scales, the discharge of ice towards the ablation region and the oceans plays this role. In electronics it is also possible to design ‘negative resistance circuits’ ([Linville, 1953](#)). Technically, this involves operational amplifiers. They inject current proportionally to the voltage. Consequently, they amplify the effects of the forcing. In palaeoclimates, the ice albedo feedback or the boreal vegetation feedback may be modelled as negative resistances because they amplify the forcing. The combination of positive and negative resistances may be summarised by an equivalent ‘net resistance’, as indicated on Figure 4.

The capacitor is a crucial component of the system. It accumulates tension, like ice sheets accumulate mass. The effect of the capacitor on the system dynamics is to introduce a phase

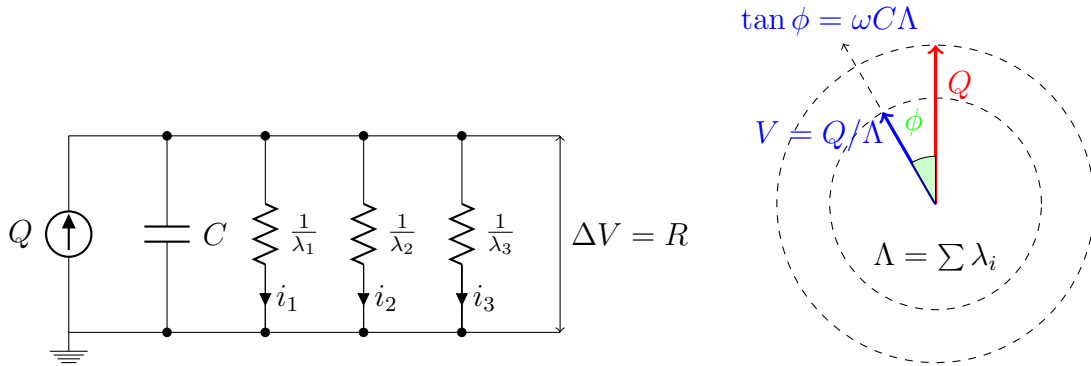

Figure 4: Linear electronic circuit as a metaphor for the climate system. The forcing is the input current Q . Depending on the framework, it may represent the annual mean radiative forcing (for a global warming experiment) or the net mass balance over ice sheets (for a Milankovitch forcing experiment). The capacitor represents the component of the climate system that effectively integrates the forcings (ocean heat content, or ice sheets mass) and the different resistances represent what are generally referred to as “feedbacks” in the climate system. The values of these resistances are consistent with the notation introduced by [Hansen et al. \(1984\)](#): Positive resistance ($\lambda > 0$ in [Hansen et al. \(1984\)](#)) correspond to “negative feedbacks” (they work against the forcing), negative resistances, in practice obtained with negative impedance circuits, are “positive feedbacks”. The system output (for example: temperature) is the voltage. At a given forcing frequency, the output lags the input with a phase $\tan^{-1}(\omega C\Lambda)$, where ω is the angular velocity of the forcing.

lag between the forcing (input current) and the response (output voltage), so that the forcing and the response may be unambiguously identified. The forcing-response phase lag is used by [Gregory et al. \(2004\)](#) to estimate the net ‘feedback’ factor (equivalent to the inverse of the net resistance in our diagram) in global warming experiments with general circulation model simulations. In palaeoclimate applications, the phase lag is estimated from the data to distinguish the response from the forcing ([Imbrie et al., 1992](#); [Shackleton, 2000](#); [Lisiecki et al., 2008](#)).

The assumption of linearity has three consequences. First, given that resistances are constant, the net resistance of the system is constant, too. Consequently, it must be positive otherwise tension (response) would run away to infinity. The implication is that small perturbations to the input (for example: noisy fluctuations) are damped with time rather than being amplified. The system remains thus predictable even in presence of small fluctuations. Second, the output voltage contains exactly the same frequencies as the input current, and every frequency can be analysed separately from the others. The technique introduced in the SPECMAP project ([Imbrie et al., 1992](#)) is compatible with this linear framework. It consists in filtering climatic signals to separate them into components related to precession (19-24 ky band, 1 ky=1,000 years), obliquity (40-ky band) and eccentricity (100-ky band), and then inspect leads and lags between the astronomical forcing and the different climatic components, such as CO_2 , ocean temperatures, dust, etc. Visually, the picture proposed by SPECMAP is a chain linking the forcing to different components, of which the response has an increasing phase lag with the forcing as one goes down the response chain (Figure 2). This analysis approach is still used nowadays (e.g. [Lisiecki et al., 2008](#)).

Third, the linear formalism cannot adequately account for the presence of saw-tooth-shaped 100-ky ice age cycles. At least three answers to this problem may be found in the literature:

1. The first solution consists in postulating the existence of some unidentified 100-ky cycle that is effectively treated as a forcing in the linear framework, even if its origin is internal to the climate system. This is the solution proposed in the SPECMAP model (*Imbrie et al., 1993*).
2. The second approach assumes that the effect of the forcing is non linear. For example, in *Imbrie and Imbrie (1980)*, the response to insolation anomaly is greater if this anomaly is positive than if it is negative. The consequence of this asymmetry is that the input signal is at least partly rectified. In particular, the precession forcing, which is the product of eccentricity and the sine of the longitude of the perihelion ($e \times \sin \varpi$) gives rise to a pure eccentricity signal in the output. The eccentricity signal contains the frequencies of 412, 94, 123 and 100 ky (*Berger, 1978*), and therefore these frequencies are also found in the output signal. *Ruddiman (2006)* proposed a conceptual model which, although not formulated mathematically, fits this category. The problem with this second approach is that the internal dynamics of the system remain linear. Only the effect of the forcing is being transformed non-linearly. Consequently, as we discussed above, there is no possibility of a runaway feedback phenomenon. This causes a problem to explain the deglaciation which occurred 400,000 years ago because insolation variations were weak at that time. If the system is stable, it cannot react dramatically to a small forcing. The problem was fully appreciated by *Imbrie and Imbrie (1980)*.
3. The third solution is to explain the emergence of an ‘internal 100-ky cycle’ as a result of non-linear interactions with the climate system. This is the subject of the next section.

2.1.3. Non-linear, deterministic models

A non-linear electronic system is one in which the effective resistance of the components vary with the tension on the system. This framework allows for a variety of new phenomena. In “some basic experiments with a vertically-integrated ice sheet model”, *Oerlemans (1981)* noted one, two or even three stable solutions may co-exist, depending on the forcing. This configuration, typical of non-linear system dynamics, may cause transient behaviours that will look very different to the forcing functions. In particular, with some modest adjustments to the model equations and parameters (as in *Pollard (1983)*), such a model may exhibit self-sustained oscillations, even if the forcing is constant. In non-linear dynamics theory, such a system is called an *oscillator*. In the *Pollard (1983)* model, the oscillation arises from interactions between the lithosphere and the ice-sheet climate system, but only when model parameters lie in a fairly narrow range, that is suitable to represent the West Antarctic ice sheet but not the northern ice sheets. Consequently, investigators have been looking for other sources of oscillations in the climate system to explain ice ages. *Saltzman and Maasch (1990)*, for example, proposed a system in which CO₂ reacts non-linearly to

changes in ocean temperature, and ocean temperature is controlled by CO₂ and continental ice volume. Contrary to the SPECMAP model, which is graphically represented as a linear chain of responses (Figure 2), the Saltzman-Maasch model is best graphically represented as a network with cyclic interactions (Figure 5). Some of these interactions act as stabilising factors (negative feedbacks, noted ‘-’), but others may be stabilising or destabilising depending on the system state. This latter characteristic allows, in the Saltzman-Maasch model, ice ages to occur even in absence of astronomical forcing. Consequently, in a non-linear system, the phase relationship between two components (for example, astronomical forcing and ice volume) is no longer a reliable indicator of the nature of the forcing (see also *Ganopolski and Roche (2009)*). Compared to linear systems, the analysis focuses less on the analysis of phase lead and lag, and is more concerned with identification of stability, bifurcation, of synchronisation, and predictability, which are now briefly reviewed.

Stability: The analysis of a non-linear dynamical system consists in identifying its stable and unstable points, that is, the states to which the system may be attracted (negative feedbacks dominate around this point) and the states from which it will be repelled (positive feedbacks dominate around this point). For example, *Brovkin et al. (1998, 2003)* estimated that non-linear interaction between vegetation and the atmosphere may explain the co-existence of several stable states in the Sahel but not at the northern high latitudes; this work was inspired in part from the pioneering contribution by *Ghil (1976)*, interested in the more general consequences of albedo feedbacks on the system stability. There may also be no stable point, which leaves us with several possibilities ⁴: (i) the system exhibits a stable self-sustained periodic oscillation; (ii) its behaviour is quasi-periodic (combination of several periods); (iii) it is aperiodic, with a broad power spectrum and complex phase-diagram figures (for example: the behaviour of ENSO modelled in *Tziperman et al. (1994)*).

Bifurcation: A bifurcation is defined as a change in system behaviour obtained when one of the system parameters crosses a threshold, called the bifurcation point. *Saltzman and Maasch (1990)*, for example, proposed models where the Middle Pleistocene Revolution is interpreted as a bifurcation. The parameter controlling this bifurcation is the background CO₂ level, which is driven by tectonics. This bifurcation corresponds to a switch from a linear response mode to astronomical forcing (before the Middle Pleistocene Revolution) to a regime of non-linear synchronisation (after the Middle Pleistocene Revolution). This model is compatible with the findings of *Lisiecki and Raymo (2007)* who show, based on time series analysis, a transition from linear to non-linear regime before the Middle Pleistocene Revolution. At a different timescale, the transition between an ‘interglacial’ and a ‘glacial’ phase may also be interpreted in terms of bifurcation theory (*Ditlevsen, 2009; Livina et al., 2011*) ⁵. Recent research

⁴see, among others, *Ghil and Ghildress (1987); Saltzman (2001)* and *Crucifix (2012)* for introductory texts on this in the palaeoclimate context

⁵The difference between the *Ditlevsen (2009)* and *Saltzman and Maasch (1990)* frameworks is quite

activity has focused on the search for ‘early warning precursors’ of a bifurcation *Dakos et al.* (2008); *Scheffer et al.* (2009); *Ditlevsen and Johnsen* (2010).

Synchronisation: Synchronisation is defined as the phenomenon by which the natural oscillation period of a system adjusts itself on the period of an external factor (*Pikovski et al.*, 2001). Conceptual models such as those by *Saltzman and Maasch* (1990), *Pailard and Parrenin* (2004) and *Tziperman et al.* (2006) exhibit a phenomenon of synchronisation to the astronomical forcing⁶ The concept of synchronisation is also useful to explain phenomena associated with Dansgaard-Oeschger and Heinrich events (*Schulz et al.*, 2002). A review is available in *Crucifix* (2012).

Predictability: Given that positive feedbacks may dominate at least at certain times in a non-linear systems, there is the possibility small perturbations be amplified so much that the exact history of the system from given initial conditions is in practice unpredictable. Some conceptual models of ice ages have this property. More specifically, climate perturbations occurring at strategic times may be amplified, and deflect the course of climate, by hastening or delaying significantly a glacial inception or a deglaciation (*De Saedeleer et al.*, 2012).

In summary, non-linear deterministic models widen the scope of plausible ice age theories and address questions at a different level than linear systems. The idea of a ‘chronological chain of response mechanisms’ is ambiguous in such systems because self-sustained loops are possible. Non-linear dynamical system theory provides a suitable vocabulary to study the effects of a network of interactions between different components of the climate system and the role of astronomical forcing.

2.1.4. Stochastic models

A stochastic process is a form of *noise*, that is, the succession of random numbers with well-defined properties such as auto-correlation and amplitude. There are two possible reasons for introducing a stochastic process in a model. One is to account for the physical phenomena that occur at smaller spatial or temporal scales than those that are explicitly resolved by the model. For example, *Hasselmann* (1976) introduced a stochastic process to account for ‘weather’ in a ‘climate’ model. The properties of the stochastic process may then be determined by reasoning on the physics of the unresolved process (*Penland*, 2007). For representing weather, it was proposed to deduce noise properties from quasi-geostrophic

fundamental but its discussion is beyond the scope of the present review.

⁶ The Southern Ocean foraminifera Fourier analysis by *Hays et al.* (1976) is often referred to as a pioneering demonstration of the influence of the astronomical forcing on climate. Retrospectively, it is tempting to interpret the title of that paper: “Variations in the Earth’s orbit, pacemaker of ice ages” as a visionary reference to the concept of synchronisation. *Hays et al.* (1976) indeed perfectly realised that occurrence of 100-ka ice ages does not fit a linear response framework of precession and obliquity. Though, as correctly observed by one reviewer of the present paper, their interpretation is closer in nature to the *Imbrie and Imbrie* (1980) model than of the self-sustained oscillation model.

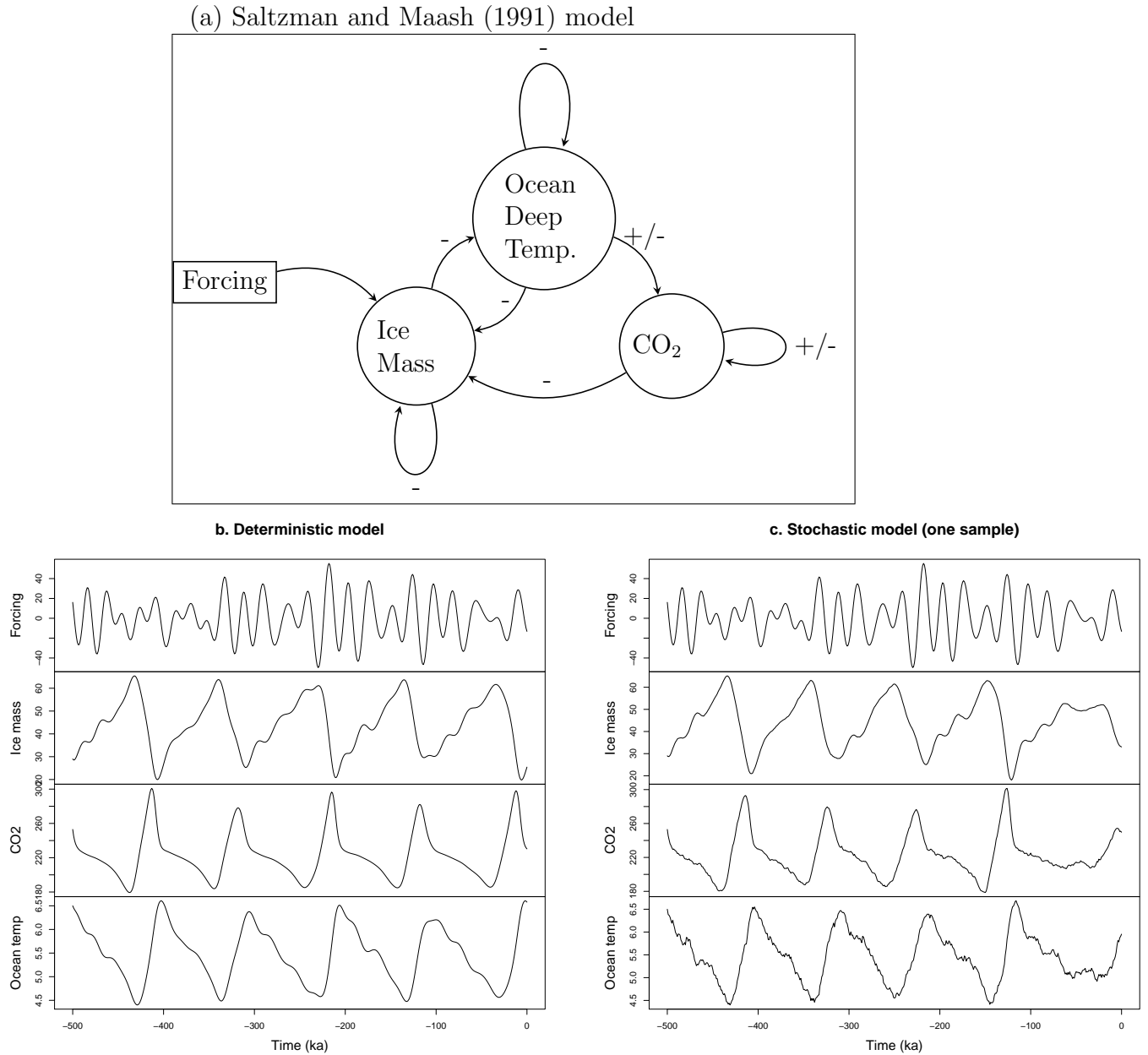

Figure 5: (a) Graphical network representation of the *Saltzman and Maasch (1990)* model of ice ages. Arrows indicate *causal* relationships. The astronomical forcing causes variations in ice volume, which then are involved in a network of interactions with deep ocean temperature and CO_2 . Contrary to the linear framework, certain feedbacks may vary and change sign depending on the system state, which induces in the *Saltzman and Maasch (1990)* model a phenomenon of self-sustained oscillations. Ice ages are, in this model, self-sustained oscillations synchronised on the astronomical forcing. The result of a simulation reproducing Figure 5 of the original publication is shown in panel (b). Additive stochastic effects may randomly alter the timing and amplitude of ice ages. One example of a stochastic realisation is shown on panel (c).

theory (*Majda et al.*, 2009). Stochastic parameterisations may also be introduced to account for uncertainties and model errors, in order to more realistically assess the horizon of predictability of the model in the presence of such errors. Technically, accounting for stochastic effects transforms the dynamical system into a ‘stochastic dynamical system’, of which the numerical resolution is both theoretically and computationally more involved than that of a deterministic system (*Kloeden and Platen*, 1999). Stochastic processes also induce a number of interesting mathematical phenomena, which in turn provide us with a series of new concepts that may be adequate to interpret the history of climate. One such concept is the ‘stochastic resonance’, in which the stochastic process is combined with a periodic forcing to induce periodic oscillations in the system. Ice ages have been interpreted in the past as a phenomenon of stochastic resonance (*Benzi et al.*, 1982). The concept of stochastic resonance itself has evolved and models showing different forms of stochastic resonance have been proposed to understand abrupt climate events (*Ganopolski and Rahmstorf*, 2002; *Timmermann et al.*, 2003; *Braun et al.*, 2007).

2.2. Climate simulators

Simulators are complex numerical systems designed to account explicitly for a large number of different processes involved in the dynamics of the climate system. A particularity of simulators is that the number of variables is several orders of magnitude greater than the number of system parameters (*Claussen et al.* (2002)). This criteria is met by general circulation models as those used, for example, in the Palaeoclimate Modelling Intercomparison Project (*Braconnot et al.*, 2007), but the definition applies also to most ‘Earth System Models of Intermediate Complexity (EMICS)’ (*Claussen et al.*, 2002), such as, among others, FAMOUS (*Smith*, 2012), LOVECLIM (*Goosse et al.*, 2010), CLIMBER-2 (*Petoukhov et al.*, 2000; *Calov et al.*, 2005), CLIMBER-3 α (*Montoya et al.*, 2005), BERN3D (*Ritz et al.*, 2010) and GENIE-1 (*Ridgwell et al.*, 2007).

The word ‘simulator’ is uncommon in the climate literature. It is adopted here on purpose to distinguish it from statistical and conceptual models. Compared to the conceptual models, the purpose of the simulator is more general, in the sense that it is developed with many possible applications in mind (a same climate simulator may be used to study El-Niño and sea-ice variability; as another example, the GENIE-1 model (*Ridgwell et al.*, 2007) contains the definition of 49 dissolved tracers, which can be enabled or disabled depending on the modeller’s purpose). At the same time, experimental designs are quite specific: among others, the shapes and orography of continents, vegetation types, soil properties and ocean bathymetry have to be specified on a given grid and adapted for a particular climate era, for example the pre-industrial era or the Last Glacial Maximum.

The interest of simulators is to generate a self-consistent picture of regional and planetary-scale phenomena that is compatible with physical and biogeochemical principles implemented at the scale of a grid-cell. A large fraction of computing resources is used to solve fluid dynamics equations that determine the movements of oceans, atmosphere, and possibly sea-ice and continental ice. The choice of spatial resolution conditions the spatio-temporal spectrum that can be studied with the simulator, ranging from weather forecast (hi-resolution models) to multi-millennial phenomena (EMICS). Physical and biogeochemical processes are

then introduced consistently. For example, a module of ocean sediment diagenesis finds its place in a simulator designed to study multi-millennial climate evolution (*Brovkin et al., 2012*), but not in a weather forecast simulator.

The simulator also involves a number of ‘sub-grid parameterisations’. These are models representing the effects of physical or biogeochemical processes that are not explicitly resolved by the simulator. The development of these parameterisations obeys the same rules as that of the conceptual models outlined above, and they may be diagnostic (assume an instantaneous equilibrium response), prognostic (the parameterisation is a dynamical system, for example, the prognostic cloud scheme of the UK Met Office model (*Wilson et al., 2008*)) and they may also include stochastic components (*Eckermann, 2011*). Sub-grid cell parameterisations contain parameters that cannot directly be measured in the laboratory or in the field (*Palmer, 2005*), but plausible ranges can be estimated from physical considerations. Consequently, at least some of these parameters are subsequently ‘tuned’ so that the simulator replicates satisfactorily planetary scale phenomena. For example, they may be adjusted to get a satisfactory thermohaline circulation. In this sense, the simulator may be viewed as a device that constrains relationships between information formulated at different time and spatial levels, namely the grid cell and the planetary scale. In addition to sub-grid parameterisations, simulators often involve a number of reasonably ad-hoc assumptions, for example about the routing of icebergs in the Atlantic ocean and the amount of freshwater subsequently delivered to the ocean surface (*Gordon et al., 2000*, p. 150).

There are different purposes to the use of simulators in palaeoclimatology.

1. One is to evaluate the simulator. The purpose is to show that the simulator reproduces palaeoclimate observations satisfactorily (or, at least, more satisfactorily than another one), and take this as an element of confidence into future climate predictions with this simulator, in the context of the anthropogenic climate change problematic (*Braconnot et al., 2007, 2012*). To this end, experiments are designed carefully to be as realistic as possible.
2. Another purpose is to construct an explanatory framework to a climate phenomenon. For example, explaining the desertification of the Sahara 6,000 years ago (*Kutzbach and Liu, 1997; Claussen et al., 1999*), the strong East-Asian monsoon signal during marine isotopic stage 13 (*Yin et al., 2008*), the timing of the Holocene climate optimum (*Renssen et al., 2009*) or the effect of different oceanic factors to variations in CO₂ (*Archer et al., 2000; Chikamoto et al., 2012*). Given the nature of simulators, one single simulation cannot count as a fully satisfactory explanation of a phenomenon. The interest of simulators lies in the possibility of designing series of “intervention” experiments (change the forcing, or take the control of certain model components, such as vegetation) in order to investigate causal relationships. Even though simulators do not replicate reality exactly, these experiments help us to quantify complex causal effects, and possibly summarise them as a visual flow diagram (cf. Section 2.1.1).
3. The third purpose is to generate information that is not immediately accessible from palaeoclimate archives. Simulator experiments may be used to provide climate reconstructions (*Paul and Schäfer-Neth, 2005*) or constrain unknown quantities, such as the

duration of hydrological perturbations associated with Heinrich Events ([Roche et al., 2004](#)).

The simulator is an imperfect representation of reality and therefore cannot replicate observations exactly. It is never ‘true’ ([Oreskes et al., 1994](#)). Consequently, modellers have been looking at ways of expressing the distance between the simulation and the reality, either qualitatively or quantitatively. The classical procedure is illustrated in Figure 6. The log of data produced by the simulation is post-processed and summarised, for example in the form of seasonal averages and maps. In parallel, palaeoclimate observations are compiled and expressed in a model-friendly (or modeller-friendly!) database, that is, they are expressed in terms of climate variables, using statistical or mechanical relationships, and aggregated on a grid (an example is the MARGO dataset ([MARGO project members, 2009](#))). Finally, the distance between observations and simulation may be discussed either qualitatively ([Otto-Bliesner et al., 2009](#)), or on the basis of formal metrics. For example, a distance metric based on fuzzy logic was proposed in the late 1990’s ([Guiot et al., 1999](#)). This particular metric was designed to avoid penalizing excessively a simulator that would reproduce climate change patterns correctly, but with shifts in location compared to reality. The model-data comparison procedure is an integral part of the modelling process. More specifically, which quantities are being looked at (seasonal averages, regional averages) and which metrics are being chosen, reflect the judgements of the modeller about which information generated by the simulator is potentially valuable for inference (cf. ([Guillemot, 2010](#)) for the science historian prospective of on this matter).

From there research efforts have taken two complementary (and non-exclusive) directions:

1. Develop process-based models for palaeoclimate observations, so that the simulator generates information of which the nature is similar to the one which is observed. The process is illustrated on Figure 7. Rather than comparing simulated climate with reconstructed climate, one compares simulated isotopes with observed isotopes ([Hoffmann et al., 1998](#); [Marchal et al., 2000](#); [LeGrande et al., 2006](#); [Roche et al., 2006](#); [Müller et al., 2006](#)) or biomes with pollen scores ([Harrison and Prentice, 2003](#); [Brewer et al., 2007](#)). As for climate models, process-based models for palaeoclimate observations are available with various levels of sophistication, and they can be intimately embedded in the climate simulator (necessary for isotopes simulation) or included as a separate post-processing module (e.g.: the BIOME model, [Kaplan et al. \(2003\)](#)). Compared to the classical procedure of climate-climate comparison, observation modelling mitigates the loss of information occurring when observations are converted into climatic variables. The modeller also has a better control on the assumptions linking climatic variables to palaeo-observations.
2. Develop sampling strategies, founded on ensembles of experiments. For example one may sample different parameter combinations of a simulator in order to explore the effect of uncertainties on the value of these parameters. The parameter combinations giving simulations comparing most favourably to palaeoclimate data may provide more trustworthy predictions ([Annan et al., 2005](#); [Schneider von Deimling et al., 2006](#)). Simulations obtained with these best parameters may also be viewed as a form of

model-data comparison

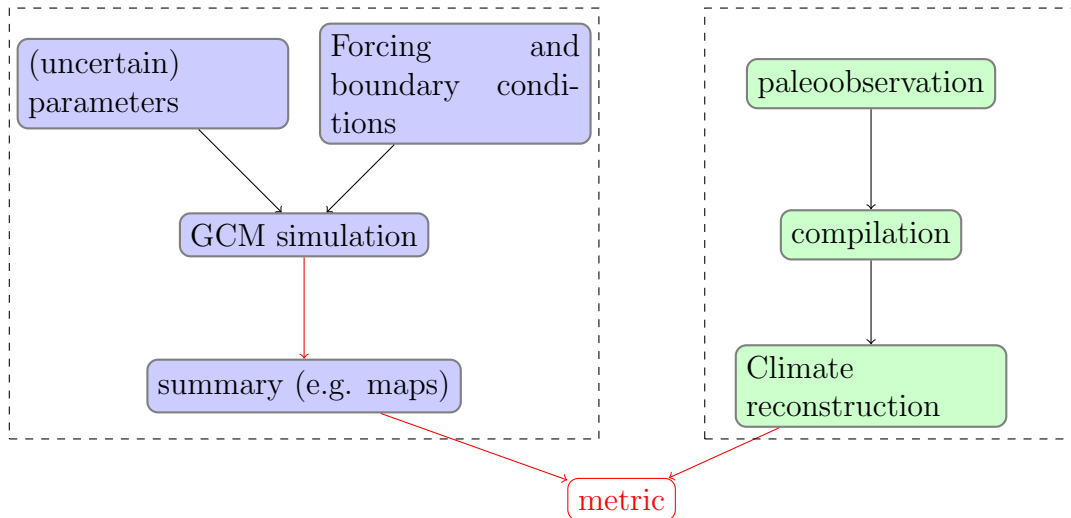

Figure 6: Classically, simulations and data-based palaeoclimate reconstructions are developed separately and then compared, either based on visual inspection, or using quantitative functions (metrics) measuring the distance between the simulation and the palaeoclimate reconstruction.

climate reconstruction (*Paul and Schäfer-Neth, 2005*). Sampling forcing scenarios may also provide constraints on the latter (*Roche et al., 2006*). With the ensemble strategy, the interest of modellers has moved from the notion of evaluating one experiment to evaluating *the experiment ensemble*, that is, asking whether climate summaries (e.g.: zonal averaged temperature) generated by the ensemble is likely to encompass the true value (*Hargreaves et al., 2011*). Section 3 provides more discussion on how an ensemble-based strategy fits a statistical approach.

2.3. Statistical modelling

A statistical model is a mathematical construction that accommodates both systematic relationships between different variables and random effects (*Davison, 2003*), and random effects are modelled through the notion of probability distributions.

In classical statistics, one generally distinguishes two objectives: testing a hypothesis, and estimating a quantity. In both cases, the inference procedure relies on the definition of quantities called ‘statistics’, and on the specification of a process that could plausibly have generated the observations.

For example, *Huybers and Wunsch (2005)* ask whether deglaciations occur systematically for a same phase of obliquity. To this end they consider a statistic called the “R” statistic, and they study the distribution of this quantity that would have been obtained if the process that generated the benthic record had been replicated a large number of times, accounting for uncertainties on the chronology. They then observe that this hypothesis *cannot* be rejected but another hypothesis, that obliquity phases at terminations are totally random, *can* be

simulation of observations

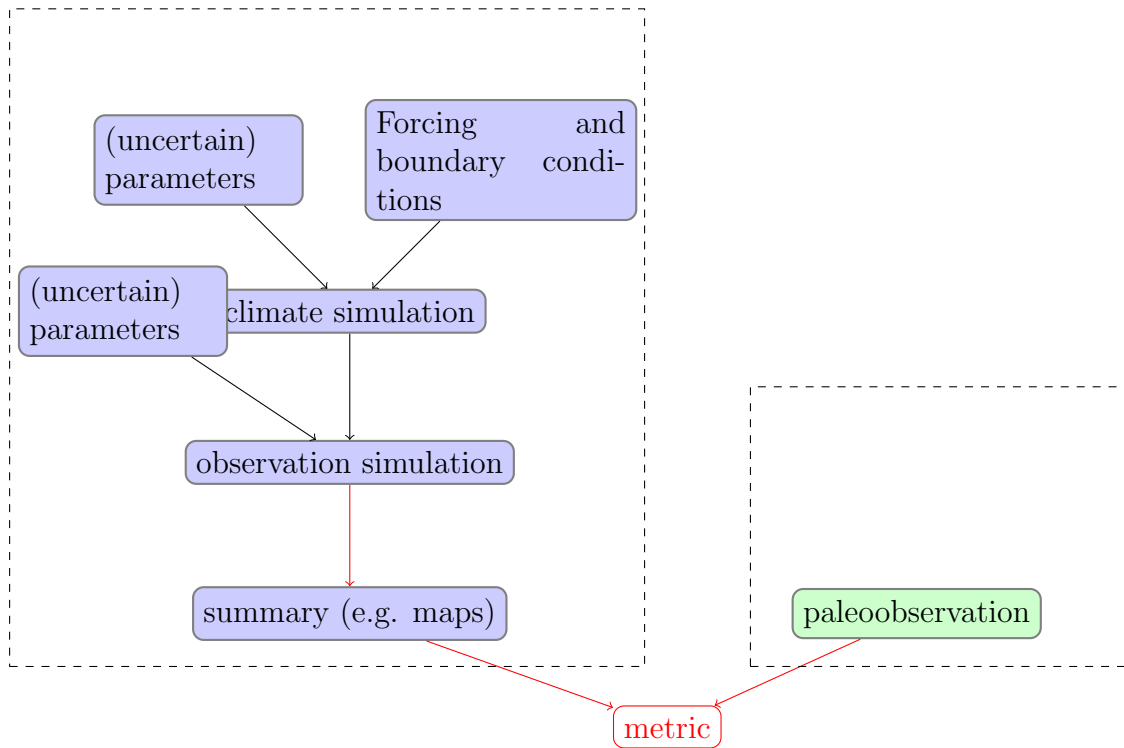

Figure 7: As an adaptation of the methodology shown in Figure 6, it is also possible to simulate palaeo-observations using appropriate models, for example, vegetation or isotope models, so that the simulation-observation comparison is done at the level of the recorded information, rather than at the level of climatic variables.

rejected. In another application, [Braun et al. \(2011\)](#) use a two-parameter process to test a possible solar influence on triggering abrupt events, and they use the ‘mean waiting time’ as the test statistic. As a last example, [Haam and Huybers \(2010\)](#) developed a statistical algorithm to test the correlation between two time series with chronological uncertainties.

So far, most problems of estimation in Quaternary palaeoclimatology were posed as a problem of regression, in which it is assumed that an observation is the sum of a systematic process and a random component. Namely, observations may be modelled as the sum of a climate-controlled component and a random observation error. Depending on the nature of the relationship, the regression problem may be solved with more or less complex techniques, including linear regression, neural networks and “best analog” approaches (e.g. [Kucera et al., 2005](#)). The problem of interpolating sparse observations on a grid may also be posed as a regression problem, and it involves then a model of the spatial dependency of observations. Discussion and application on sea-surface temperature estimates of the Last Glacial Maximum are available in [Schäfer-Neth et al. \(2005\)](#). Finally, specific time-process models have been tailored for palaeoclimate time-series analysis. In particular, the ‘RAMPFIT’ model ([Mudelsee, 2000](#)) assumes a linear trend between two plateaus. It was used to estimate the timing of the Northern Hemisphere glaciation based on foraminifera data ([Mudelsee and Raymo, 2005](#)).

More recently, palaeoclimate scientists have become interested in modelling probability distributions of uncertain variables, and the Bayesian approach provides a framework to this end. The principle is the following. Observations are modelled as the output of a process expressed mathematically. The process generally involves a number of parameters. In the Bayesian formalism, knowledge on the natural process is being incorporated by different channels. The first one is the structure of the equations that represent the process. Examples are given later in this review, in which sophisticated vegetation or climate models are used to this end; though the modeller may chose a very general model. For example, autoregressive processes are a very broad class of models that express the fact that the system has a memory. Physical knowledge also concerns the range of values that parameters may plausibly take. This is the second channel. This information is incorporated in the Bayesian statistical model under the form of *prior* probability distributions of parameters, which reflect the judgements of the modeller about the probability that the parameters will take this or that value. Finally, observations are accounted for in a mathematical procedure that consists in updating the prior distributions on parameters by application of the Bayes’ law of conditional probabilities. This operation is achieved by resorting to a function called the likelihood. This is a function of the parameters, which expresses the degree of consistency between the model output obtained with these parameters, and observations at hand ⁷. The resulting probability distribution of the parameters, which combines prior and likelihood, is called the *posterior* probability distribution.

⁷Technical definitions of the likelihood and explanation of Bayesian calculus are available in classical textbooks, such as [Davison \(2003\)](#), but the broader discussion by ([Jaynes, 2003](#), chap. 3) is also quite enlightening.

The Bayesian formalism is also equipped with a concept to quantify the degree of self-consistency between these different informations. The relevant quantity is called the marginal likelihood: Among different models, the one with the highest marginal likelihood is generally to be preferred. Though, this is by no means automatic. Assessing a model remains a broad and partly subjective procedure that involves testing it against independent data, and discussing its structure based on physical considerations.

Bayesian models were proposed to estimate distributions of sediment age based on uncertain radiocarbon dates (*Blaauw and Christen, 2005; Haslett and Parnell, 2008*), infer the posterior distribution of Holocene temperatures based on chironomid taxa abundances (*Korhola et al., 2002*), or estimate ice core chronologies (*Lemieux-Dudon et al., 2010*).

The Bayesian approach also provides the flexibility needed to construct ‘hierarchical models’ (Figure 8). The hierarchical model chains different sub-models to form a consistent forward description of the process that leads to the observation. For example, it is possible to articulate a process to model response of climate to a forcing, with one model that expresses the response of a climate record to climate (for example: $\delta^{18}\text{O}$ in a marine sediment). The statistical resolution of the problem consists in finding the joined probability distribution of all variables involved in the model, based on prior evidence and observations.

Hierarchical modelling was recently introduced in palaeoclimate applications. *Haslett et al. (2006)* use a hierarchical model to reconstruct climate from pollen samples on the site of Glendalough in Ireland. *Li et al. (2010)* apply a hierarchical model to estimate the evolution of annual mean, northern hemisphere temperature during the last millennium based on three observation time series and three estimates of the climate forcing (volcanoes, solar and greenhouse gases), and *Tingley and Huybers (2010)* combined model for the geographic correlation and correlation of climate states in a model, which they then chained with a model for the observations. They called this model ‘BARCAST’, for “Bayesian Algorithm for Reconstructing Climate Anomalies in Space and Time”, and they compare it with different other approaches, Bayesian or not, in *Tingley et al. (2012)*.

3. Combining statistical with process-based modelling

3.1. Principle

The purpose of process-based modelling is to articulate physical and biogeochemical principles, be they deterministic or stochastic. Statistical modelling, on the other hand, is concerned with inference about uncertain variables. Here we show how these two approaches may be combined. To illustrate the principle, consider the work of *Guiot et al. (2000)*. In this study, the BIOME3 process-based vegetation model (*Haxeltine and Prentice, 1996*) is used to generate prior distributions of the state vegetation in modern and past climates. The prior is then updated based on observed pollen fossil samples. The approach is thus statistical in principle, but physical or biogeochemical principles are used to restrict the range of scenarios that may be admitted as plausible. Likewise, *Annan et al. (2005)* considered a range of parameters of the climate simulator MIROC2 to generate a plausible probability distribution of the climate of the Last Glacial Maximum. They obtained a posterior distribution of the

Hierarchical statistical modelling

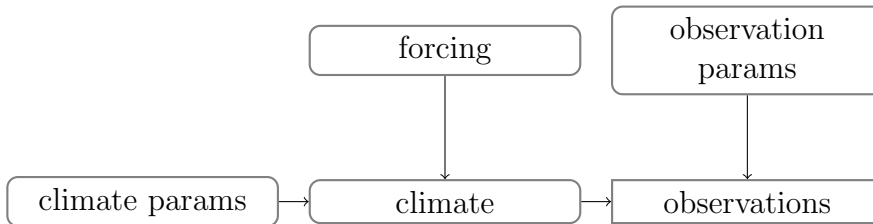

Figure 8: The hierarchical model is a statistical model, which can be represented graphically using a graphical network as shown here. The purpose of the network is to represent what each variable depends statistically on. In this example, the state of climate depends on parameters (describing climate processes) and on the forcing. What is being actually observed (observations) depends on climate and on a number of parameters that control the way climate information is being stored in climate’s natural archive. Statistical inference consists in updating our knowledge of climate and parameters, given observations and knowledge of the forcing.

parameters of that model, which they used to construct a posterior distribution of climate sensitivity to anthropogenic perturbations.

Unfortunately, process-based models are imperfect. Hence, the output of a process-based model cannot be taken as a plausible exact representation of reality, even if the model parameters are carefully chosen (*Goldstein and Rougier (2006)* and *Rougier (2007)*). Consequently, it was argued that one cannot really be satisfied with sampling model parameters in order to generate a prior distribution of plausible climates *Rougier (2007)*. Statisticians and climate scientists must therefore co-operate in order to develop a representation of the residual distance between the climate simulator and reality. This distance is called *discrepancy (Goldstein and Rougier, 2006)*. The discrepancy is a model in itself. It usually involves parameters, which can be defined a priori and updated. For example, *Schmittner et al. (2011)* use the combination of a constant bias and a spatially-covariate process to link the results of the UVic model to continental and marine palaeodata, although more work is still needed to quantify the effect of this discrepancy on current estimates of climate sensitivity. These considerations lead us to a proposal programme for inference combining simulators with statistical reasoning that follows the schematics shown on Figure 9. At least three challenges are being faced in this enterprise: sampling priors, expressing discrepancy, and identifying a tractable resolution algorithm. The present review is concerned with sampling priors only, because this is the area where progress has been the most tangible over the recent years.

3.2. Time slice modelling

To illustrate the challenge consider the problem of reconstructing the climate of the Last Glacial Maximum. Suppose the climate-process model is a simulator like HadCM3 (*Gordon et al., 2000*), or any similar climate simulator. Experts are being elicited to identify a short-list of, say, 10 uncertain input parameters, which are thought to influence the simulated climate significantly. The problem is to sample this 10-dimension parameter space. If, for

Simulator-assisted probabilistic-modelling

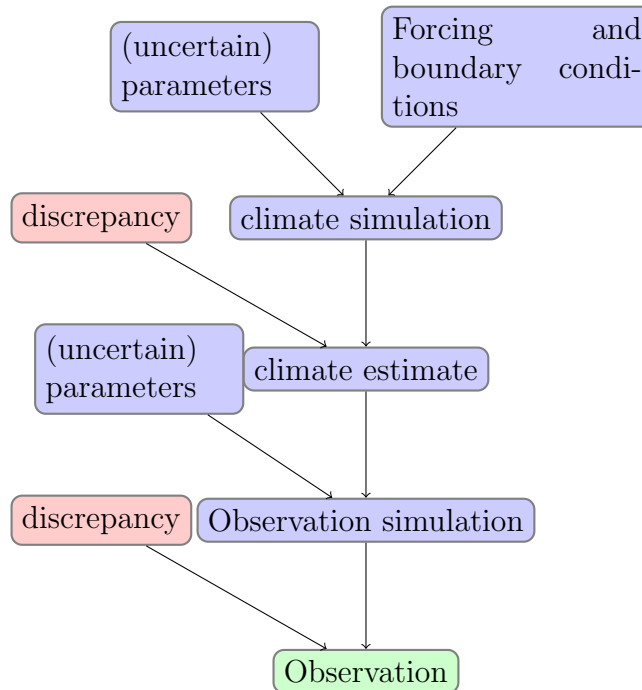

Figure 9: Information provided by climate simulators may be involved in a hierarchical model similar to Figure 8. Climate is modelled as the combination of climate simulations and discrepancy; and observations are modelled as the combination of a process-based observation model (for example: a vegetation model such as BIOME) and discrepancy.

every parameter, 5 different values are being tried, 5^{10} experiments need to be run. That makes a bit less than 10 million experiments, each of which takes several weeks of super-computer time. This is naturally impossible.

On this question, the literature opposes two approaches. The first one consists in searching methodically the region of maximum likelihood (or, maximum posterior) and estimate the local curvature of the likelihood (or, posterior) around it. To this end, the modeller may resort to the *adjoint* of the simulator. This is a mathematical or software device that estimates sensitivity (formally: the gradient) of the model state with respect to its parameters. The adjoint method was recently illustrated in the palaeoclimate context ([Paul and Losch, 2012](#)). The reader is referred to textbooks for a more formal definition adjoint approach, including [Kalnay \(2002\)](#) and [Wunsch \(2006\)](#). The approach is efficient, but it may fail if the posterior has several local maxima.

The second approach is to sample the 10-dimensional parameter space sparsely but smartly. The challenge is then to choose carefully the experiments to be run, such as to extract as much information as possible. This is a problem of ‘experiment design for computer experiments’, for which a theory is being developed ([Santner et al., 2003](#)), and several articles focus explicitly on climate applications ([Urban and Fricker, 2010](#); [Challenor, 2011](#)). Once experiments have been run, the output of the simulator has to be interpolated throughout the entire 10-dimensional space. This reminds us of the spatial interpolation problem (interpolate sparse observations on a regular mesh). Unsurprisingly, interpolation methods for computer experiments use some of the mathematics of spatial modelling and, in particular, the Gaussian process ([Rasmussen and Williams, 2005](#)). The literature on the subject mainly relies on the Bayesian formalism, and the interpolator is called in this context an ‘emulator’ ([Kennedy and O’Hagan, 2000](#); [Oakley and O’Hagan, 2002](#)). The modeller’s choice may be to emulate global quantities, such as the globally averaged temperature ([Olson et al., 2012](#)). In practice, though, palaeoclimate applications often require to reconstruct the spatial distribution of temperature, precipitation, and other climatic quantities. Several solutions have been proposed, including the Principal-Component-Analysis-emulator ([Wilkinson, 2010](#)) and the outer-product emulator ([Rougier, 2008](#)). Both options were tested in [Schmittner et al. \(2011\)](#) (in their supplementary material).

3.3. Dynamical modelling

Let us now focus on the dynamical climate evolution over Quaternary time scales. The role of the climate process-based model is to provide a physical prior on the physical relationships between the different climatic variables.

Here, one should distinguish two different possible objectives. One objective is to *reconstruct* a coherent picture of climate evolution, using physical constraints. This is a problem of *state estimation*. Another objective is to enquire about climate mechanisms by testing hypotheses and estimate parameters. The second task can be translated into a Bayesian statistical framework as a problem of *parameter estimation*. Here we review state and parameter estimation separately.

3.3.1. State estimation

In principle state estimation in dynamical systems is a fairly standard problem for which a number of solutions exist, based on the Kalman filter (e.g. [Evensen and van Leeuwen, 2000](#)) or the particle filter ([Doucet et al., 2001](#)). In practice, palaeoclimate applications involve numerical systems for which a direct application of these technologies would be overwhelmingly expensive. Consequently, somewhat ad hoc, application-dependent algorithms were suggested.

For example, [Bintanja et al. \(2005\)](#) use a thermodynamical ice-sheet model, including an explicit representation of oxygen isotope balance within the ice sheet, coupled to a simple representation of the deep ocean and the atmosphere. Given observations of only certain variables of the model (here: deep ocean $\delta^{18}\text{O}$), the problem is to reconstruct the state of all system variables, and, in particular, deep-ocean temperature and continental ice mass. This is a typical problem of state estimation, which was solved in this case by a time-step wise iterative procedure.

Another palaeoclimate application is the spatio-temporal reconstruction—for example, reconstructing the geographical distribution of temperature throughout the last millennium—using climate simulators. At the palaeoclimate time scale the only tractable approach today relies on low resolution general circulation models belonging to the category of climate models of intermediate complexity. If the ocean or atmosphere dynamics are chaotic (this is the case in ‘LOVECLIM’, [Goosse et al. \(2005\)](#)) then one needs to assimilate observations sequentially, that is, one after the next as time progresses. [Dubinkina et al. \(2011\)](#) and [Goosse et al. \(2012\)](#) have proposed to solve this problem with a low-computational version of the particle filter.

3.3.2. Parameter estimation

Calibrating the parameters in a model on observations allows one to update prior knowledge on the relationships between different climate variables. The most tractable solution (i.e., the least computational intensive) is to rely on a low-order dynamical system, for example a conceptual model, of which the execution is almost instantaneous on a computer. Even though the model is highly idealised, inference on model parameters may provide information on causal relationships between the different components of the Earth system. For example, if one parameter controls the effect of precession on ocean circulation, it is informative to know if this parameter is with high probability different to zero. One model proposed in the literature for such applications is the [Saltzman and Maasch \(1990\)](#) model. The methodological developments aiming at using this model in a statistical setting have paralleled those for snapshot reconstructions discussed in the previous subsection: Early attempts are based on sampling uncertain parameters assuming that the model is perfect ([Hargreaves and Annan, 2002](#)), and later attempts have included a stochastic component to account for model discrepancy ([Crucifix and Rougier, 2009](#)). If the stochastic model is unstable, i.e., if two climate reconstructions simulated with two different but plausible realisations of the model error term vary widely, then the introduction of stochastic processes makes the parameter estimation task a particularly difficult problem, about which literature is scattered between the traditions of physics and dynamical system theory (see [Voss](#)

Dynamic emulator project

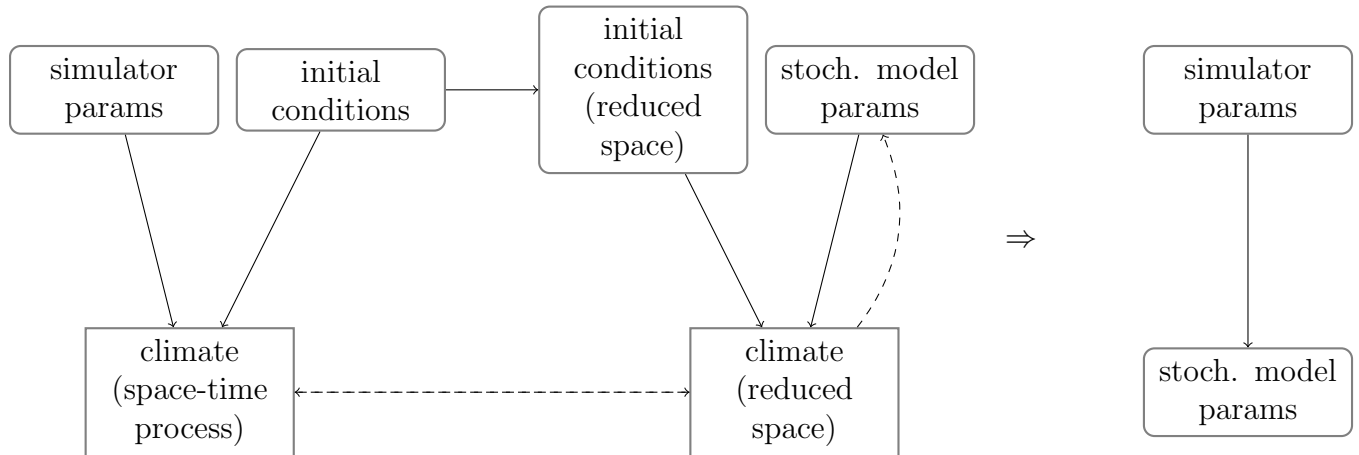

Figure 10: In the dynamic emulator project, for which [Young and Ratto \(2011\)](#) provide theoretical background and applications, the simulator is identified to a reduced, stochastic model, operating in a reduced space. For example, instead of the full geographical distribution, the stochastic dynamical system works on the space of principal components. For every set of parameters of the simulator, a corresponding set of parameters for the stochastic dynamical system can be estimated such as to reproduce results obtained with the full simulator as well as possible. The dynamical emulator then consists of the combination of the stochastic dynamical system with a statistical model, mapping simulator parameters on stochastic model parameters.

[et al. \(2004\)](#) for a general review, and [Kwasniok and Lohmann \(2009\)](#) for an application on Dansgaard-Oeschger events), and statistics (see [Ionides et al. \(2006\)](#); [Liu and West \(2001\)](#) and [Andrieu et al. \(2010\)](#) for three different approaches to the problem).

It may be objected that conceptual models contain too little physical information, and that using more comprehensive simulators is desirable. The objection has merit, but how to deal with the subsequent intractable computational would unavoidably emerge? [Young and Ratto \(2011\)](#) proposed a strategy to address this specific problem, relying on the technique of dynamical system identification. This a two-step process (Figure 10).

The first step consists in finding a stochastic dynamical system that reproduces adequately the output of a simulator that encapsulates the desired physics. A number of practical examples are already available in the literature:

1. [Hooss et al. \(2001\)](#) considered an ocean carbon cycle model developed to compute the oceanic uptake of CO_2 called HAMOCC1. HAMOCC1 is a complex simulator, resolving the three-dimensional fluid dynamics and a number of oceanic tracers involved in the carbon and nutrient cycles. The model outputs three-dimensional fields. [Hooss et al. \(2001\)](#) estimated the principal spatial patterns of the simulator output, and calibrated a finite impulse response model predicting the response of the coefficients of the principal patterns, in order to reproduce the full output of HAMOCC1. They further corrected the model slightly to account for second-order non-linearities related to CO_2

uptake.

2. The LLN2D model is a simulator of the growth and decay of the three major northern ice sheets, in response to variations in carbon dioxide and astronomical forcing (*Gallée et al., 1992*). The proposed surrogate of this model (*Crucifix, 2011*) is a second-order (hence, non-linear) equation governing the total amount of continental ice, suitable to account for the co-existence of two stable steady-states in this model.
- 3&4. Finally, *Young and Ratto (2009)* considers, among others, two applications: (a) the *Enting and Lassey (1993)* model of the global carbon cycle, which is itself a somewhat elaborate dynamical system, with 23 coupled nonlinear equations and (b) the HadCM3 climate simulator (*Gordon et al., 2000*), used in response to anthropogenic greenhouse gas increases scenarios. For both applications a surrogate model is obtained by calibrating a ‘Transfer function model’⁸

The second step consists of the *Young and Ratto (2011)* strategy is to model the relationship between the parameters of the simulator and the parameters of the surrogate stochastic dynamical system using a Gaussian process. One then obtains a solution to explore the response of the simulator to different combinations of parameter and forcing, by actually running the surrogate stochastic dynamical system. In this context, *Young and Ratto (2011)* calls the combination of the surrogate dynamical system with the model of the relationship between the parameters of the simulator and those of the surrogate system, a *dynamical emulator*. So far no palaeoclimate application of this technique is available.

3.4. Emulator by-products

The emulator was introduced and defined as a statistical surrogate of a simulator used to sample efficiently the space of uncertain parameters. More generally, the whole process of designing and calibrating an emulator is a procedure aiming at extracting information efficiently from a complex numerical system. This is a computing cost economiser, which comes with at least two possible applications in addition to the problems of parameter and state estimation discussed above:

1. Once the emulator is properly calibrated and tested, there is almost no limit to the number of sensitivity experiments to model inputs that may be run, because they are run with the emulator rather than with the actual simulator. Consequently, the sensitivity of the simulator can be explored very finely and span the whole input space, which includes boundary conditions, forcing and parameters. The procedure provides us with a way to characterise the non-linear structure of the model response and, in particular, identify thresholds and plateaus. *Oakley and O’Hagan (2004)* provide some theoretical background to this end.

⁸ Transfer-function models are classical in dynamical system identification theory (*Ljung, 1999*). The assumption is that moving-averaged outputs and moving averaged-inputs are linearly correlated to each other.

2. Given the computational resources required to run general circulation models in palaeoclimate applications, modellers generally chose to degrade the spatial resolution and simplify the physics (for example: assume that cloud cover is constant, or simplify the relationship between large scale atmospheric dynamics and precipitation) compared to state of the art simulators. This is the rationale for the use of Earth System Models of Intermediate Complexity (*Claussen et al., 2002*). However, these physical simplifications have deleterious effects on the representation and the response structure of certain processes thought to play a role at the global scale, including tropical monsoons, El-Niño, Southern ocean ventilation and North Atlantic convection. The emulator provides an alternative to this reduced-physics strategy, by offering the possibility of running numerous experiments with an emulator calibrated on a simulator, rather than with the simulator itself.

This being said, developing an emulator is by no means straightforward, be it in the static or in the dynamic framework. The choice of emulator structure, inputs, and regressors is a fairly heuristic procedure that requires expertise on the simulator and the processes that it is meant to represent. In particular, one cannot overstate the importance of extensive validation tests of the emulator: the user must be confident that the emulator is consistent with the simulator dynamics and avoid unsuitable interpretations. The literature on emulator validation and design is developing (*Bastos and O'Hagan, 2009*) (cf. also the www.mucm.ac.uk website) and should be carefully examined before any application. The natural recommendation, echoed by *Young and Ratto (2011)* (and references therein) is to adopt a framework that is as simple as possible, chosen such that the parameters of the surrogate model can be interpreted in terms of system dynamics and system sensitivity.

4. Conclusion

The present article reviewed three modelling approaches adequate to study palaeoclimate phenomena:

1. Conceptual models provide a representation of a well-identified phenomenon like ice ages, Dansgaard-Oeschger events or Heinrich events. These models are specific to the studied phenomenon, and their development obeys a principle of parsimony: explaining as much as possible with as little as possible. In spite of this principle of parsimony, there may be a risk of over-interpretation. Two conceptual models relying on different mechanistic interpretations may have similar mathematical descriptions, and thus fit the same dataset equally well (*Tziperman et al., 2006; Cane et al., 2006; Crucifix, 2012*). Consequently, a model fit does not necessarily imply that the underlying causal interpretation is correct. As a general rule, the model will be more convincing if it accommodates different forms of information, that is: different records ($\delta^{18}O$, CO_2 , SST, . . .), different aspects of the record (trends, noise, auto-correlation, . . .), and captures transitions between different regimes (for example: the Middle Pleistocene Revolution) with few free parameters. The theory of dynamical system tells us that chaotic and other counter-intuitive mathematical phenomena may arise in deceptively simple

systems. For this reason, dynamical system identification, which we briefly reviewed at the end of the article, is useful as a tool for analysing the dynamics of simulators used to generate time series. If the behaviour of a complex simulator can be reproduced with a compact, stochastic dynamical system, it can be more easily analysed from the prospective of dynamical system theory.

2. Simulators provide a spatially-resolved representation of numerous physical and biogeochemical processes involved in the climate system. Simulators are more versatile in nature than conceptual models. Depending on the experimental design, the same climate simulator may be used to study different climatic phenomena at different time and/or spatial scales. Causal effects may be explored by means of intervention experiments, in which one of the components of the system is being taken control of (e.g.: fixed or ‘imposed’ ice sheets, vegetation, CO₂ etc.) However, it would be a mistake to regard simulators as *ab initio* models of the climate system. To the extent simulators and their sub-grid scale parameterisations are tuned to adequately reproduce planetary scale phenomena (globally-average temperature, the Atlantic meridional overturning cell, monsoon dynamics), simulators are partly empirical. Scientists working with climate simulators are aware of this and for this reason they develop stringent tests to assess the performance of these models, both for the representation of the present-day climate and for the past climates.
3. Statistical modelling accommodates systematic relationships—but not necessarily causal—between different variables with random effects. Statistical modelling may in particular be involved in space-time climate reconstruction, hypothesis testing and parameter estimation, but it should never be overlooked that these mathematical operations are constrained by a number of hypotheses expressed in the statistical model. Common statistical assumptions concern the autocorrelation of data in time and space, and between the climate state and actual observations. Hierarchical modelling is increasingly used because it provides a more explicit representation of the forward mechanical process linking the causes of the phenomenon to actual observations.

One of the purposes of the review is to show that statistics, and Bayesian statistics in particular, have a role to play to articulate these frameworks. In particular, they allow us to include information on a priori physically plausible model parameter ranges in the inference process.

Unfortunately there is no free lunch. A brute-force sampling approach may involve millions or even billions of experiments, which cannot be envisaged even with the simplest systems. Consequently, resolution algorithms tend to be mathematically highly involved, and resort to intermediate modelling steps such as the emulator or the adjoint, experiment planning, along with new and not yet solidly established concepts such as the discrepancy. These modelling steps and associated resolution algorithms need to be evaluated carefully and this procedure is tedious and technical. What has been gained on the one hand (a more transparent expression of the conditions of inference) has to be paid by the technical character of the inference process, which may appear obscure and off-putting to a significant fraction of the scientific audience.

The conclusion follows naturally. The established paradigms of modelling that were reviewed here (conceptual, simulator and statistical modelling) still have an important role to play because they allow scientists to build on years of achievement and experience. Conceptual modelling, in particular, is a flexible approach to organise observations involved in complex climatic processes. On the other hand, the power of cross-paradigm approaches, allying statistics with simulators, or statistics with conceptual models, should not be overlooked. They offer avenues to manage uncertainties and rationalise model design and selection given different and variate sources of information.

Acknowledgements

I dedicate this article to the many authors of the admirable articles from the 70s and 80s that were cited here. They are an endless source of inspiration and motivation. The review benefited from interactions with Jonathan Rougier (University of Bristol), Didier Paillard (LSCE, Gif-sur-Yvette), Nabila Bounceur and Carlos Almeida (both from Université catholique de Louvain), as well as from the comments by two reviewers. I am also indebted to Caitlin Buck (University of Sheffield) for managing the SUPRAnet international scientific network (<http://caitlin-buck.staff.shef.ac.uk/SUPRAnet/>), of which I have largely benefited. I am research associate with the Belgian National Fund of Scientific Research, and this research is funded by the European Research Council, Starting Grant contract nr 2009-StG-239604 ITOP.

References

- Andrieu, C., A. Doucet, and R. Holenstein, Particle Markov chain Monte Carlo methods, *Journal of the Royal Statistical Society: Series B (Statistical Methodology)*, 72(3), 269–342, doi:[10.1111/j.1467-9868.2009.00736.x](https://doi.org/10.1111/j.1467-9868.2009.00736.x), 2010.
- Annan, J. D., J. C. Hargreaves, R. Ohgaito, A. Abe-Ouchi, and S. Emori, Efficiently constraining climate sensitivity with ensembles of paleoclimate experiments, *SOLA*, 1, 181–184, doi:[10.2151/sola.2005-047](https://doi.org/10.2151/sola.2005-047), 2005.
- Archer, D., A. Winguth, D. Lea, and N. Mahowald, What caused the glacial/interglacial atmospheric pCO₂ cycles?, *Reviews of Geophysics*, 38(2), 159–189, doi:[10.1029/1999RG000066](https://doi.org/10.1029/1999RG000066), 2000.
- Bastos, L. S., and A. O’Hagan, Diagnostics for Gaussian process emulators, *Technometrics*, 51(4), 425–438, doi:[10.1198/TECH.2009.08019](https://doi.org/10.1198/TECH.2009.08019), 2009.
- Benzi, R., G. Parisi, A. Sutera, and A. Vulpiani, Stochastic resonance in climatic change, *Tellus*, 34(1), 10–16, doi:[10.1111/j.2153-3490.1982.tb01787.x](https://doi.org/10.1111/j.2153-3490.1982.tb01787.x), 1982.
- Berger, A. L., Long-term variations of daily insolation and Quaternary climatic changes, *J. Atmos. Sci.*, 35, 2362–2367, doi:[10.1175/1520-0469\(1978\)035<2362:LTVODI>2.0.CO;2](https://doi.org/10.1175/1520-0469(1978)035<2362:LTVODI>2.0.CO;2), 1978.

- Bintanja, R., R. S. W. van de Wal, and J. Oerlemans, Modelled atmospheric temperatures and global sea levels over the past million years, *Nature*, 437(7055), 125–128, doi:[10.1038/nature03975](https://doi.org/10.1038/nature03975), 2005.
- Blaauw, M., and J. A. Christen, Radiocarbon peat chronologies and environmental change, *Journal of the Royal Statistical Society: Series C (Applied Statistics)*, 54(4), 805–816, doi:[10.1111/j.1467-9876.2005.00516.x](https://doi.org/10.1111/j.1467-9876.2005.00516.x), 2005.
- Braconnot, P., S. P. Harrison, M. Kageyama, P. J. Bartlein, V. Masson-Delmotte, A. Abe-Ouchi, B. Otto-Bliesner, and Y. Zhao, Evaluation of climate models using palaeoclimatic data, *Nature Climate Change*, 2(6), 417–424, doi:[10.1038/nclimate1456](https://doi.org/10.1038/nclimate1456), 2012.
- Braconnot, P., et al., Results of PMIP2 coupled simulations of the Mid Holocene and Last Glacial Maximum – Part 1: experiments and large-scale features, *Climate of the Past*, 3, 261–277, doi:[10.5194/cp-3-261-2007](https://doi.org/10.5194/cp-3-261-2007), 2007.
- Braun, H., A. Ganopolski, M. Christl, and D. R. Chialvo, A simple conceptual model of abrupt glacial climate events, *Nonlinear Processes in Geophysics*, 14(6), 709–721, doi:[10.5194/npg-14-709-2007](https://doi.org/10.5194/npg-14-709-2007), 2007.
- Braun, H., P. Ditlevsen, J. Kurths, and M. Mudelsee, A two-parameter stochastic process for Dansgaard-Oeschger events, *Paleoceanography*, 26(3), PA3214, doi:[10.1029/2011PA002140](https://doi.org/10.1029/2011PA002140), 2011.
- Brewer, S., J. Guiot, and F. Torre, Mid-Holocene climate change in Europe: a data-model comparison, *Climate of the Past*, 3(3), 499–512, doi:[10.5194/cp-3-499-2007](https://doi.org/10.5194/cp-3-499-2007), 2007.
- Broecker, W. S., The great ocean conveyor, *Oceanography*, 4, 79–89, 1991.
- Brovkin, V., M. Claussen, V. Petoukhov, and A. Ganopolski, On the stability of the atmosphere-vegetation system in the sahara/sahel region, *J. Geophys. Res.*, 103(D24), 31,613–31,624, doi:[10.1029/1998JD200006](https://doi.org/10.1029/1998JD200006), 1998.
- Brovkin, V., S. Levis, M. F. Loutre, M. Crucifix, M. Claussen, A. Ganopolski, C. Kubatzki, and V. Petoukhov, Stability analysis of the climate-vegetation system in the northern high latitudes, *Clim. Change*, 57(1-2), 119–138, 2003.
- Brovkin, V., A. Ganopolski, D. Archer, and G. Munhoven, Glacial CO₂ cycle as a succession of key physical and biogeochemical processes, *Climate of the Past*, 8(1), 251–264, doi:[10.5194/cp-8-251-2012](https://doi.org/10.5194/cp-8-251-2012), 2012.
- Calov, R., A. Ganopolski, M. Claussen, V. Petoukhov, and R. Greve, Transient simulation of the last glacial inception. Part I: glacial inception as a bifurcation in the climate system, *Climate Dynamics*, 24(6), 545–561, doi:[10.1007/s00382-005-0007-6](https://doi.org/10.1007/s00382-005-0007-6), 2005.
- Cane, M. A., et al., Progress in paleoclimate modeling, *Journal of Climate*, 19(20), 5031–5057, doi:[10.1175/JCLI3899.1](https://doi.org/10.1175/JCLI3899.1), 2006.

- Challenor, P., Designing a computer experiment that involves switches, *Journal of Statistical Theory and Practice*, 5(1), 47–57, doi:[10.1080/15598608.2011.10412049](https://doi.org/10.1080/15598608.2011.10412049), 2011.
- Chikamoto, M. O., A. Abe-Ouchi, A. Oka, R. Ohgaito, and A. Timmermann, Quantifying the ocean’s role in glacial CO₂ reductions, *Climate of the Past*, 8(2), 545–563, doi:[10.5194/cp-8-545-2012](https://doi.org/10.5194/cp-8-545-2012), 2012.
- Claussen, M., C. Kubatzki, V. Brovkin, A. Ganopolski, P. Hoelzmann, and H.-J. Pachur, Simulation of an abrupt change in Saharan vegetation in the mid-Holocene, *Geophysical Research Letters*, 26, 2037–2040, doi:[10.1029/1999GL900494](https://doi.org/10.1029/1999GL900494), 1999.
- Claussen, M., et al., Earth system models of intermediate complexity: closing the gap in the spectrum of climate system models, *Climate Dynamics*, 18(7), 579–586, doi:[10.1007/s00382-001-0200-1](https://doi.org/10.1007/s00382-001-0200-1), 2002.
- Crucifix, M., How can a glacial inception be predicted?, *The Holocene*, 21(5), 831–842, doi:[10.1177/0959683610394883](https://doi.org/10.1177/0959683610394883), 2011.
- Crucifix, M., Oscillators and relaxation phenomena in pleistocene climate theory, *Philosophical Transactions of the Royal Society A: Mathematical, Physical and Engineering Sciences*, 370(1962), 1140–1165, doi:[10.1098/rsta.2011.0315](https://doi.org/10.1098/rsta.2011.0315), 2012.
- Crucifix, M., and J. Rougier, On the use of simple dynamical systems for climate predictions: A Bayesian prediction of the next glacial inception, *European Physics Journal - Special Topics*, 174, 11–31, doi:[10.1140/epjst/e2009-01087-5](https://doi.org/10.1140/epjst/e2009-01087-5), 2009.
- Dakos, V., M. Scheffer, E. H. van Nes, V. Brovkin, V. Petoukhov, and H. Held, Slowing down as an early warning signal for abrupt climate change, *Proceedings of the National Academy of Sciences of the United States of America*, 105(38), 14,308–14,312, doi:[10.1073/pnas.0802430105](https://doi.org/10.1073/pnas.0802430105), 2008.
- Davison, A. C., *Statistical models*, Cambridge Series in Statistical and Probabilistic Modelling, Cambridge University Press, 2003.
- De Saedeleer, B., M. Crucifix, and S. Wiczorek, Is the astronomical forcing a reliable and unique pacemaker for climate? a conceptual model study, *Climate Dynamics*, p. online first, doi:[10.1007/s00382-012-1316-1](https://doi.org/10.1007/s00382-012-1316-1), 2012.
- Ditlevsen, P. D., Bifurcation structure and noise-assisted transitions in the Pleistocene glacial cycles, *Paleoceanography*, 24, PA3204, doi:[10.1029/2008PA001673](https://doi.org/10.1029/2008PA001673), 2009.
- Ditlevsen, P. D., and S. J. Johnsen, Tipping points: Early warning and wishful thinking, *Geophys. Res. Lett.*, 37(19), L19,703, doi:[10.1029/2010GL044486](https://doi.org/10.1029/2010GL044486), 2010.
- Doucet, A., N. de Freitas, and N. Gordon (Eds.), *Sequential Monte Carlo Methods in Practice*, New York: Springer, 2001.

- Dubinkina, S., H. Goosse, Y. Sallaz-Damaz, E. Crespin, and M. Crucifix, Testing a particle filter to reconstruct climate changes over the past centuries, *International Journal of Bifurcation and Chaos*, *21*, 3611–3618, doi:[10.1142/S0218127411030763](https://doi.org/10.1142/S0218127411030763), 2011.
- Eckermann, S. D., Explicitly stochastic parameterization of nonorographic gravity wave drag, *Journal of the Atmospheric Sciences*, *68*(8), 1749–1765, doi:[10.1175/2011JAS3684.1](https://doi.org/10.1175/2011JAS3684.1), 2011.
- Enting, I. G., and K. R. Lassey, Projections of future CO₂., *Technical Report 27*, Division of Atmospheric Research, CSIRO, Melbourne, 1993.
- Evensen, G., and P. J. van Leeuwen, An ensemble Kalman smoother for nonlinear dynamics, *Monthly Weather Review*, *128*(6), 1852–1867, doi:[10.1175/1520-0493\(2000\)128<1852:AEKSFN>2.0.CO;2](https://doi.org/10.1175/1520-0493(2000)128<1852:AEKSFN>2.0.CO;2), 2000.
- Gallée, H., J. P. van Ypersele, T. Fichefet, I. Marsiat, C. Tricot, and A. Berger, Simulation of the last glacial cycle by a coupled, sectorially averaged climate-ice sheet model. Part II : Response to insolation and CO₂ variation, *Journal of Geophysical Research*, *97*, 15,713–15,740, doi:[10.1029/92JD01256](https://doi.org/10.1029/92JD01256), 1992.
- Ganopolski, A., and S. Rahmstorf, Abrupt glacial climate changes due to stochastic resonance, *Phys. Rev. Lett.*, *88*(3), 038,501, doi:[10.1103/PhysRevLett.88.038501](https://doi.org/10.1103/PhysRevLett.88.038501), 2002.
- Ganopolski, A., and D. M. Roche, On the nature of lead–lag relationships during glacial–interglacial climate transitions, *Quaternary Science Reviews*, *28*(27–28), 3361–3378, doi:[10.1016/j.quascirev.2009.09.019](https://doi.org/10.1016/j.quascirev.2009.09.019), 2009.
- Ghil, M., Climate stability for a sellers-type model, *Journal of the Atmospheric Sciences*, *33*(1), 3–20, 1976.
- Ghil, M., and S. Ghildress, *Topics in Geophysical Fluid Dynamics: Atmospheric Dynamics, Dynamo Theory and Climate Dynamics, Applied Mathematical Sciences*, vol. 60, Springer-Verlag, 1987.
- Ghil, M., and H. Le Treut, A climate model with cryodynamics and geodynamics, *Journal of Geophysical Research*, *86*(C6), 5262–5270, doi:[10.1029/JC086iC06p05262](https://doi.org/10.1029/JC086iC06p05262), 1981.
- Goldstein, M., and J. Rougier, Bayes linear calibrated prediction for complex systems, *Journal of the American Statistical Association*, *101*, 1132–1143, doi:[10.1198/016214506000000203](https://doi.org/10.1198/016214506000000203), 2006.
- Goosse, H., H. Renssen, A. Timmermann, and R. S. Bradley, Internal and forced climate variability during the last millennium: a model-data comparison using ensemble simulations, *Quaternary Science Reviews*, *24*(12–13), 1345–1360, doi:[10.1016/j.quascirev.2004.12.009](https://doi.org/10.1016/j.quascirev.2004.12.009), 2005.

- Goosse, H., E. Crespin, S. Dubinkina, M.-F. Loutre, M. Mann, H. Renssen, Y. Sallaz-Damaz, and D. Shindell, The role of forcing and internal dynamics in explaining the “medieval climate anomaly”, *Climate Dynamics*, p. online first, doi:[10.1007/s00382-012-1297-0](https://doi.org/10.1007/s00382-012-1297-0), 2012.
- Goosse, H., et al., Description of the Earth system model of intermediate complexity LOVE-CLIM version 1.2, *Geoscientific Model Development*, *3*(2), 603–633, doi:[10.5194/gmd-3-603-2010](https://doi.org/10.5194/gmd-3-603-2010), 2010.
- Gordon, C., C. Cooper, C. A. Senior, H. Banks, J. M. Gregory, T. C. Johns, J. F. B. Mitchell, and R. A. Wood, The simulation of SST, sea ice extents and ocean heat transports in a version of the Hadley Centre coupled model without flux adjustments, *Climate Dynamics*, *16*, 147–168, doi:[10.1007/s003820050010](https://doi.org/10.1007/s003820050010), 2000.
- Gregory, J. M., W. J. Ingram, M. A. Palmer, G. S. Jones, P. A. Stott, R. B. Thorpe, J. A. Lowe, T. C. Johns, and K. D. Williams, A new method for diagnosing radiative forcing and climate sensitivity, *Geophysical Research Letters*, *31*(3), L03,205, doi:[10.1029/2003GL018747](https://doi.org/10.1029/2003GL018747), 2004.
- Guillemot, H., Connections between simulations and observation in climate computer modeling. scientist’s practices and “bottom-up epistemology” lessons, *Studies In History and Philosophy of Science Part B: Studies In History and Philosophy of Modern Physics*, *41*(3), 242–252, doi:[10.1016/j.shpsb.2010.07.003](https://doi.org/10.1016/j.shpsb.2010.07.003), 2010.
- Guiot, J., J. J. Boreux, P. Braconnot, and F. Torre, Data-model comparison using fuzzy logic in paleoclimatology, *Climate Dynamics*, *15*(8), 569–581, doi:[10.1007/s003820050301](https://doi.org/10.1007/s003820050301), 1999.
- Guiot, J., F. Torre, D. Jolly, O. Peyron, J. J. Boreux, and R. Cheddadi, Inverse vegetation modeling by monte carlo sampling to reconstruct palaeoclimates under changes precipitation seasonality and co₂ conditions: application to glacial climate in mediterranean region, *Ecological Modelling*, *127*, 119–140, doi:[10.1016/S0304-3800\(99\)00219-7](https://doi.org/10.1016/S0304-3800(99)00219-7), 2000.
- Haam, E., and P. Huybers, A test for the presence of covariance between time-uncertain series of data with application to the Dongge Cave speleothem and atmospheric radiocarbon records, *Paleoceanography*, *25*(2), PA2209, doi:[10.1029/2008PA001713](https://doi.org/10.1029/2008PA001713), 2010.
- Hansen, J. E., A. Lacis, D. Rind, L. Russell, P. Stone, I. Fung, R. Ruedy, and J. Lerner, Climate sensitivity: analysis of feedback mechanisms, in *Climate Processes and Climate Sensitivity*, edited by J. E. Hansen and T. Takahashi, pp. 130–163, American Geophysical Union, Washington D. C., 1984.
- Hargreaves, J. C., and J. D. Annan, Assimilation of paleo-data in a simple Earth system model, *Climate Dynamics*, *19*, 371–381, doi:[10.1007/s00382-002-0241-0](https://doi.org/10.1007/s00382-002-0241-0), 2002.
- Hargreaves, J. C., A. Paul, R. Ohgaito, A. Abe-Ouchi, and J. D. Annan, Are paleoclimate model ensembles consistent with the MARGO data synthesis?, *Climate of the Past*, *7*(3), 917–933, doi:[10.5194/cp-7-917-2011](https://doi.org/10.5194/cp-7-917-2011), 2011.

- Harrison, S. P., and I. C. Prentice, Climate and CO₂ controls on global vegetation distribution at the Last Glacial Maximum: analysis based on palaeovegetation data, biome modelling and palaeoclimate simulations, *Global Change Biology*, 9(7), 983–1004, doi:[10.1046/j.1365-2486.2003.00640.x](https://doi.org/10.1046/j.1365-2486.2003.00640.x), 2003.
- Haslett, J., and A. Parnell, A simple monotone process with application to radiocarbon-dated depth chronologies, *Journal of the Royal Statistical Society: Series C (Applied Statistics)*, 57(4), 399–418, doi:[10.1111/j.1467-9876.2008.00623.x](https://doi.org/10.1111/j.1467-9876.2008.00623.x), 2008.
- Haslett, J., M. Whiley, S. Bhattacharya, M. Salter-Townshend, S. P. Wilson, J. R. M. Allen, B. Huntley, and F. J. G. Mitchell, Bayesian palaeoclimate reconstruction, *Journal of the Royal Statistical Society: Series A (Statistics in Society)*, 169(3), 395–438, 2006.
- Hasselmann, K., Stochastic climate models part I. Theory, *Tellus*, 28(6), 473–485, doi:[10.1111/j.2153-3490.1976.tb00696.x](https://doi.org/10.1111/j.2153-3490.1976.tb00696.x), 1976.
- Haxeltine, A., and I. C. Prentice, BIOME3: An equilibrium terrestrial biosphere model based on ecophysiological constraints, resource availability, and competition among plant functional types, *Global Biogeochem. Cycles*, 10(4), 693–709, doi:[10.1029/96GB02344](https://doi.org/10.1029/96GB02344), 1996.
- Hays, J. D., J. Imbrie, and N. J. Shackleton, Variations in the Earth’s orbit : Pacemaker of ice ages, *Science*, 194, 1121–1132, doi:[10.1126/science.194.4270.1121](https://doi.org/10.1126/science.194.4270.1121), 1976.
- Held, I. M., The gap between simulation and understanding in climate modelling, *Bull. Am. Meteorol. Soc.*, 86(11), 1609–1614, doi:[10.1175/BAMS-86-11-1609](https://doi.org/10.1175/BAMS-86-11-1609), 2005.
- Hoffmann, G., M. Werner, and M. Heimann, Water isotope module of the ECHAM atmospheric general circulation model: A study on timescales from days to several years, *Journal of Geophysical Research*, 103(D14), 16,871–16,896, doi:[10.1029/98JD00423](https://doi.org/10.1029/98JD00423), 1998.
- Hooss, G., R. Voss, K. Hasselmann, E. Maier-Reimer, and F. Joos, A nonlinear impulse response model of the coupled carbon cycle-climate system (NICCS), *Climate Dynamics*, 18, 189–202, doi:[10.1007/s003820100170](https://doi.org/10.1007/s003820100170), 10.1007/s003820100170, 2001.
- Huybers, P., and C. Wunsch, Obliquity pacing of the late Pleistocene glacial terminations, *Nature*, 434, 491–494, doi:[10.1038/nature03401](https://doi.org/10.1038/nature03401), 2005.
- Imbrie, J., and J. Z. Imbrie, Modelling the climatic response to orbital variations, *Science*, 207, 943–953, doi:[10.1126/science.207.4434.943](https://doi.org/10.1126/science.207.4434.943), 1980.
- Imbrie, J., et al., On the structure and origin of major glaciation cycles 1. Linear responses to Milankovitch forcing, *Paleoceanography*, 7(6), 701–738, doi:[10.1029/93PA02751](https://doi.org/10.1029/93PA02751), 1992.
- Imbrie, J., et al., On the structure and origin of major glaciation cycles. Part 2: The 100,000-year cycle, *Paleoceanography*, 8, 699–735, 1993.

- Ionides, E. L., C. Bretó, and A. A. King, Inference for nonlinear dynamical systems, *Proceedings of the National Academy of Sciences*, *103*(49), 18,438–18,443, doi:[10.1073/pnas.0603181103](https://doi.org/10.1073/pnas.0603181103), 2006.
- Jaynes, E. T., *Probability Theory : The Logic of Science*, Cambridge University Press, Cambridge, UK, 2003.
- Kalnay, E., *Atmospheric Modeling, Data Assimilation and Predictability*, Cambridge University Press, Cambridge, UK, 2002.
- Kaplan, J. O., et al., Climate change and Arctic ecosystems: 2. Modeling, paleodata-model comparisons, and future projections, *Journal of Geophysical Research*, *108*(D19), doi:[10.1029/2002JD002559](https://doi.org/10.1029/2002JD002559), 2003.
- Kennedy, M. C., and A. O’Hagan, Predicting the output from a complex computer code when fast approximations are available, *Biometrika*, *87*(1), 1–13, doi:[10.1093/biomet/87.1.1](https://doi.org/10.1093/biomet/87.1.1), 2000.
- Kloeden, P. E., and E. Platen, *Numerical solution of stochastic differential equations, Application of mathematics, stochastic modelling and applied probability*, vol. 23, 3rd ed. ed., Springer Berlin / Heidelberg, 1999.
- Köhler, P., H. Fischer, G. Munhoven, and R. E. Zeebe, Quantitative interpretation of atmospheric carbon records over the last glacial termination, *Global Biogeochemical Cycles*, *19*(4), doi:[10.1029/2004GB002345](https://doi.org/10.1029/2004GB002345), 2005.
- Korhola, A., K. Vasko, H. T. T. Toivonen, and H. Olander, Holocene temperature changes in northern Fennoscandia reconstructed from chironomids using Bayesian modelling, *Quaternary Science Reviews*, *21*(16–17), 1841–1860, doi:[10.1016/S0277-3791\(02\)00003-3](https://doi.org/10.1016/S0277-3791(02)00003-3), 2002.
- Kucera, M., A. Rosell-Melé, R. Schneider, C. Waelbroeck, and W. Winelt, Multiproxy approach for the reconstruction of the glacial ocean surface (MARGO), *Quaternary Science Reviews*, *24*, 813–819, doi:[10.1016/j.quascirev.2004.07.017](https://doi.org/10.1016/j.quascirev.2004.07.017), 2005.
- Kutzbach, J. E., and Z. Liu, Response of the African monsoon to orbital forcing and ocean feedbacks in the middle Holocene, *Science*, *278*(5337), 440–443, doi:[10.1126/science.278.5337.440](https://doi.org/10.1126/science.278.5337.440), 1997.
- Kwasniok, F., and G. Lohmann, Deriving dynamical models from paleoclimatic records: Application to glacial millennial-scale climate variability, *Phys. Rev. E*, *80*, 066,104, doi:[10.1103/PhysRevE.80.066104](https://doi.org/10.1103/PhysRevE.80.066104), 2009.
- LeGrande, A. N., G. A. Schmidt, D. T. Shindell, C. V. Field, R. L. Miller, D. M. Koch, G. Faluvegi, and G. Hoffman, Consistent simulations of multiple proxy responses to an abrupt climate change event, *Proceedings of the National Academy of Sciences*, *103*, 837–842, doi:[10.1073/pnas.0510095103](https://doi.org/10.1073/pnas.0510095103), 2006.

- Lemieux-Dudon, B., E. Blayo, J.-R. Petit, C. Waelbroeck, A. Svensson, C. Ritz, J.-M. Barnola, B. M. Narcisi, and F. Parrenin, Consistent dating for Antarctic and Greenland ice cores, *Quaternary Science Reviews*, 29(1–2), 8–20, doi:[10.1016/j.quascirev.2009.11.010](https://doi.org/10.1016/j.quascirev.2009.11.010), 2010.
- Li, B., D. W. Nychka, and C. M. Ammann, The value of multiproxy reconstruction of past climate, *Journal of the American Statistical Association*, 105(491), 883–895, doi:[10.1198/jasa.2010.ap09379](https://doi.org/10.1198/jasa.2010.ap09379), 2010.
- Linville, J. G., Transistor negative-impedance converters, *Proceedings of the IRE*, 41, 725–729, 1953.
- Lisiecki, L. E., and M. E. Raymo, Plio-Pleistocene climate evolution: trends and transitions in glacial cycles dynamics, *Quaternary Sci. Rev.*, 26, 56–69, doi:[10.1016/j.quascirev.2006.09.005](https://doi.org/10.1016/j.quascirev.2006.09.005), 2007.
- Lisiecki, L. E., M. E. Raymo, and W. B. Curry, Atlantic overturning responses to Late Pleistocene climate forcings, *Nature*, 456(7218), 85–88, doi:[10.1038/nature07425](https://doi.org/10.1038/nature07425), 2008.
- Liu, J., and M. West, Combined parameter and state estimation in simulation-based filtering, in *Sequential Monte Carlo Methods in Practice*, edited by A. Doucet, N. de Freitas, and N. Gordon, Springer, 2001.
- Livina, V. N., F. Kwasniok, G. Lohmann, J. W. Kantelhardt, and T. M. Lenton, Changing climate states and stability: from pliocene to present, *Climate Dynamics*, 37(11–12), 2437–2453, doi:[10.1007/s00382-010-0980-2](https://doi.org/10.1007/s00382-010-0980-2), 2011.
- Ljung, L., *System identification – Theory for the User*, Prentice Hall, Upper-Saddle River, N. J., 1999.
- Majda, A. J., C. Franzke, and D. Crommelin, Normal forms for reduced stochastic climate models, *Proceedings of the National Academy of Sciences of the United States of America*, 106(10), 3649–3653, doi:[10.1073/pnas.0900173106](https://doi.org/10.1073/pnas.0900173106), 2009.
- Marchal, O., R. Francois, T. Stocker, and F. Joos, Ocean thermohaline circulation and sedimentary $^{231}\text{Pa}/^{230}\text{Th}$ ratio, *Paleoceanography*, 15, 625–641, doi:[10.1029/2000PA000496](https://doi.org/10.1029/2000PA000496), 2000.
- MARGO project members, Constraints on the magnitude and patterns of ocean cooling at the Last Glacial Maximum, *Nature Geosciences*, 2(2), 127–132, doi:[10.1038/ngeo411](https://doi.org/10.1038/ngeo411), 2009.
- Montoya, M., A. Griesel, A. Levermann, J. Mignot, M. Hofmann, A. Ganopolski, and S. Rahmstorf, The earth system model of intermediate complexity CLIMBER-3 α . Part I: description and performance for present-day conditions, *Climate Dynamics*, 25(2), 237–263, doi:[10.1007/s00382-005-0044-1](https://doi.org/10.1007/s00382-005-0044-1), 2005.

- Mouchet, A., and E. Deleersnijder, The leaky funnel model, a metaphor of the ventilation of the World Ocean as simulated in an OGCM, *Tellus A*, 60(4), 761–774, doi:[10.1111/j.1600-0870.2008.00322.x](https://doi.org/10.1111/j.1600-0870.2008.00322.x), 2008.
- Mudelsee, M., Ramp function regression: a tool for quantifying climate transitions, *Computers & Geosciences*, 26(3), 293–307, doi:[10.1016/S0098-3004\(99\)00141-7](https://doi.org/10.1016/S0098-3004(99)00141-7), 2000.
- Mudelsee, M., and M. E. Raymo, Slow dynamics of the Northern Hemisphere glaciation, *Paleoceanography*, 20, PA4022, doi:[10.1029/2005PA001153](https://doi.org/10.1029/2005PA001153), 2005.
- Müller, S. A., F. Joos, N. R. Edwards, and T. F. Stocker, Water mass distribution and ventilation time scales in a cost-efficient, three-dimensional ocean model, *Journal of Climate*, 19(21), 5479–5499, doi:[10.1175/JCLI3911.1](https://doi.org/10.1175/JCLI3911.1), 2006.
- Munhoven, G., Glacial-interglacial rain ratio changes: Implications for atmospheric CO₂ and ocean-sediment interaction, *Deep Sea Research Part II: Topical Studies in Oceanography*, 54(5-7), 722–746, doi:[10.1016/j.dsr2.2007.01.008](https://doi.org/10.1016/j.dsr2.2007.01.008), 2007.
- Oakley, J., and A. O’Hagan, Bayesian inference for the uncertainty distribution of computer model outputs, *Biometrika*, 89(4), 769–784, doi:[10.1093/biomet/89.4.769](https://doi.org/10.1093/biomet/89.4.769), 2002.
- Oakley, J. E., and A. O’Hagan, Probabilistic sensitivity analysis of complex models: a Bayesian approach, *Journal of the Royal Statistical Society: Series B (Statistical Methodology)*, 66(3), 751–769, doi:[10.1111/j.1467-9868.2004.05304.x](https://doi.org/10.1111/j.1467-9868.2004.05304.x), 2004.
- Oerlemans, J., Model experiments on the 100,000-yr glacial cycle, *Nature*, 287(2), 430–432, doi:<http://dx.doi.org/10.1038/287430a0>, 1980.
- Oerlemans, J., Some basic experiments with a vertically-integrated ice sheet model, *Tellus*, 33(1), 1–11, doi:[10.1111/j.2153-3490.1981.tb01726.x](https://doi.org/10.1111/j.2153-3490.1981.tb01726.x), 1981.
- Olson, R., R. Sriver, M. Goes, N. M. Urban, H. D. Matthews, M. Haran, and K. Keller, A climate sensitivity estimate using Bayesian fusion of instrumental observations and an Earth system model, *Journal of Geophysical Research*, 117(D4), D04,103, doi:[10.1029/2011JD016620](https://doi.org/10.1029/2011JD016620), 2012.
- Oreskes, N., K. Shrader-Frechette, and K. Belitz, Verification, validation, and confirmation of numerical models in the earth sciences, *Science*, 263(5147), 641–646, doi:[10.1126/science.263.5147.641](https://doi.org/10.1126/science.263.5147.641), 1994.
- Otto-Bliesner, B. L., et al., A comparison of PMIP2 model simulations and the MARGO proxy reconstruction for tropical sea surface temperatures at last glacial maximum, *Climate Dynamics*, 32(6), 799–815, doi:[10.1007/s00382-008-0509-0](https://doi.org/10.1007/s00382-008-0509-0), 2009.
- Paillard, D., The hierarchical structure of glacial climatic oscillations: interactions between ice-sheet dynamics and climate, *Climate Dynamics*, 11, 162–177, doi:[10.1007/BF00223499](https://doi.org/10.1007/BF00223499), 1995.

- Paillard, D., The timing of Pleistocene glaciations from a simple multiple-state climate model, *Nature*, *391*, 378–381, doi:[10.1038/34891](https://doi.org/10.1038/34891), 1998.
- Paillard, D., Glacial cycles: Toward a new paradigm, *Reviews of Geophysics*, *39*(3), 325–346, doi:[10.1029/2000RG00009](https://doi.org/10.1029/2000RG00009), 2001.
- Paillard, D., and L. Labeyrie, Role of the thermohaline circulation in the abrupt warming after Heinrich events, *Nature*, *372*(6502), 162–164, doi:[10.1038/372162a0](https://doi.org/10.1038/372162a0), 1994.
- Paillard, D., and F. Parrenin, The Antarctic ice sheet and the triggering of deglaciations, *Earth Planet. Sc. Lett.*, *227*, 263–271, doi:[10.1016/j.epsl.2004.08.023](https://doi.org/10.1016/j.epsl.2004.08.023), 2004.
- Palmer, T., Global warming in a nonlinear climate - can we be sure?, *Europhysics News*, *36*(2), 42–46, doi:[10.1051/epn:2005202](https://doi.org/10.1051/epn:2005202), 2005.
- Paul, A., and M. Losch, Perspectives of parameter and state estimation in palaeoclimatology, in *Climate Change: Inferences from Paleoclimate and Regional Aspects*, edited by M. F. Berger, A. and D. Sijacki, pp. 93–105, doi:[10.1007/978-3-7091-0973-1_7](https://doi.org/10.1007/978-3-7091-0973-1_7), 2012.
- Paul, A., and C. Schäfer-Neth, How to combine sparse proxy data and coupled climate models, *Quaternary Science Reviews*, *24*(7–9), 1095–1107, doi:[10.1016/j.quascirev.2004.05.010](https://doi.org/10.1016/j.quascirev.2004.05.010), 2005.
- Penland, C., Stochastic linear models of nonlinear geosystems, in *Nonlinear Dynamics in Geosciences*, edited by A. A. Tsonis and J. B. Elsner, pp. 485–515, Springer New York, 2007.
- Petoukhov, V., A. Ganopolski, V. Brovkin, M. Claussen, A. Eliseev, C. Kubatzki, and S. Rahmstorf, CLIMBER-2: a climate system model of intermediate complexity. part I: model description and performance for present climate, *Climate Dynamics*, *16*, 1–17, doi:[10.1007/PL00007919](https://doi.org/10.1007/PL00007919), 2000.
- Pikovski, A., M. Rosenblum, and J. Kurths, *Synchronization: a universal concept in nonlinear sciences*, *Cambridge Nonlinear Science Series*, vol. 12, Cambridge University Press, New York, 2001.
- Pollard, D., A coupled climate-ice sheet model applied to the Quaternary ice ages, *Journal of Geophysical Research*, *88*(C12), 7705–7718, doi:[10.1029/JC088iC12p07705](https://doi.org/10.1029/JC088iC12p07705), 1983.
- Rahmstorf, S., The thermohaline circulation: a system with dangerous thresholds?, *Climatic Change*, *46*, 247–256, doi:[10.1023/A:1005648404783](https://doi.org/10.1023/A:1005648404783), 2000.
- Rasmussen, C., and C. Williams, *Gaussian Processes for Machine Learning*, Adaptive Computation And Machine Learning, MIT Press, Cambridge MA, 2005.
- Renssen, H., H. Seppa, O. Heiri, D. M. Roche, H. Goosse, and T. Fichefet, The spatial and temporal complexity of the Holocene thermal maximum, *Nature Geosciences*, *2*(6), 411–414, doi:[10.1038/ngeo513](https://doi.org/10.1038/ngeo513), 2009.

- Ridgwell, A., J. C. Hargreaves, N. R. Edwards, J. D. Annan, T. M. Lenton, R. Marsh, A. Yool, and A. Watson, Marine geochemical data assimilation in an efficient earth system model of global biogeochemical cycling, *Biogeosciences*, *4*(1), 87–104, doi:[10.5194/bg-4-87-2007](https://doi.org/10.5194/bg-4-87-2007), 2007.
- Ritz, S. P., T. F. Stocker, and F. Joos, A coupled dynamical ocean–energy balance atmosphere model for paleoclimate studies, *Journal of Climate*, *24*(2), 349–375, doi:[10.1175/2010JCLI3351.1](https://doi.org/10.1175/2010JCLI3351.1), 2010.
- Roche, D., D. Paillard, and E. Cortijo, Constraints on the duration and freshwater release of Heinrich event 4 through isotope modelling, *Nature*, *432*(7015), 379–382, doi:[10.1038/nature03059](https://doi.org/10.1038/nature03059), 2004.
- Roche, D. M., Y. Donnadieu, E. Pucéat, and D. Paillard, Effect of changes in $\delta^{18}\text{O}$ content of the surface ocean on estimated sea surface temperatures in past warm climate, *Paleoceanography*, *21*(2), PA2023, doi:[10.1029/2005PA001220](https://doi.org/10.1029/2005PA001220), 2006.
- Rougier, J., Probabilistic inference for future climate using an ensemble of climate model evaluations, *Climatic Change*, *81*, 247–264, doi:[10.1007/s10584-006-9156-9](https://doi.org/10.1007/s10584-006-9156-9), 2007.
- Rougier, J., Efficient emulators for multivariate deterministic functions, *Journal of Computational and Graphical Statistics*, *17*(4), 827–843, doi:[10.1198/106186008X384032](https://doi.org/10.1198/106186008X384032), 2008.
- Ruddiman, W. F., Ice-driven CO_2 feedback on ice volume, *Climate of the Past*, *2*, 43–55, doi:[10.5194/cp-2-43-2006](https://doi.org/10.5194/cp-2-43-2006), 2006.
- Saltzman, B., Finite amplitude free convection as an initial value problem—I, *Journal of the Atmospheric Sciences*, *19*(4), 329–341, doi:[10.1175/1520-0469\(1962\)019<0329:FAFCAA>2.0.CO;2](https://doi.org/10.1175/1520-0469(1962)019<0329:FAFCAA>2.0.CO;2), 1962.
- Saltzman, B., *Dynamical paleoclimatology: Generalized Theory of Global Climate Change (International Geophysics)*, *International Geophysics Series*, vol. 80, Academic Press, 2001.
- Saltzman, B., and K. A. Maasch, A first-order global model of late Cenozoic climate, *Transactions of the Royal Society of Edinburgh Earth Sciences*, *81*, 315–325, doi:[10.1017/S0263593300020824](https://doi.org/10.1017/S0263593300020824), 1990.
- Santner, T., B. Williams, and W. Notz, *The Design and Analysis of Computer Experiments*, New York: Springer, 2003.
- Schäfer-Neth, C., A. Paul, and S. Mulitza, Perspectives on mapping the MARGO reconstructions by variogram analysis/kriging and objective analysis, *Quaternary Science Reviews*, *24*(7–9), 1083–1093, doi:[10.1016/j.quascirev.2004.06.017](https://doi.org/10.1016/j.quascirev.2004.06.017), 2005.
- Scheffer, M., et al., Early-warning signals for critical transitions, *Nature*, *461*(7260), 53–59, doi:[10.1038/nature08227](https://doi.org/10.1038/nature08227), 2009.

- Schmittner, A., N. M. Urban, J. D. Shakun, N. M. Mahowald, P. U. Clark, P. J. Bartlein, A. C. Mix, and A. Rosell-Melé, Climate sensitivity estimated from temperature reconstructions of the Last Glacial Maximum, *Science*, *334*(6061), 1385–1388, doi:[10.1126/science.1203513](https://doi.org/10.1126/science.1203513), 2011.
- Schneider von Deimling, T., H. Held, A. Ganopolski, and S. Rahmstorf, Climate sensitivity estimated from ensemble simulations of glacial climate, *Climate Dynamics*, *27*, 149–163, doi:[10.1007/s00382-006-0126-8](https://doi.org/10.1007/s00382-006-0126-8), 2006.
- Schulz, M., A. Paul, and A. Timmermann, Relaxation oscillators in concert: a framework for climate change at millennial timescales during the late Pleistocene, *Geophysical Research Letters*, *29*(24), 2193, doi:[10.1029/2002GL016144](https://doi.org/10.1029/2002GL016144), 2002.
- Schwartz, S., Feedback and sensitivity in an electrical circuit: an analog for climate models, *Climatic Change*, *106*(2), 315–326, doi:[10.1007/s10584-010-9903-9](https://doi.org/10.1007/s10584-010-9903-9), 2011.
- Shackleton, N. J., The 100,000-year ice-age cycle identified and found to lag temperature, carbon dioxide and orbital eccentricity, *Science*, *289*, 1897–1902, doi:[10.1126/science.289.5486.1897](https://doi.org/10.1126/science.289.5486.1897), 2000.
- Smith, R. S., The FAMOUS climate model (versions XFXWB and XHCC): description update to version XDBUA, *Geoscientific Model Development*, *5*(1), 269–276, doi:[10.5194/gmd-5-269-2012](https://doi.org/10.5194/gmd-5-269-2012), 2012.
- Stommel, H., Thermohaline convection with two stable regimes of flow, *Tellus*, *13*, 224–230, doi:[10.1111/j.2153-3490.1961.tb00079.x](https://doi.org/10.1111/j.2153-3490.1961.tb00079.x), 1961.
- Timmermann, A., H. Gildor, M. Schulz, and E. Tziperman, Coherent resonant millennial-scale climate oscillations triggered by massive meltwater pulses, *Journal of Climate*, *16*(15), 2569–2585, doi:[10.1175/1520-0442\(2003\)016<2569:CRMCOT>2.0.CO;2](https://doi.org/10.1175/1520-0442(2003)016<2569:CRMCOT>2.0.CO;2), 2003.
- Tingley, M. P., and P. Huybers, A bayesian algorithm for reconstructing climate anomalies in space and time. Part I: Development and applications to paleoclimate reconstruction problems., *Journal of Climate*, *23*(10), 2759–2781, doi:[10.1175/2009JCLI3015.1](https://doi.org/10.1175/2009JCLI3015.1), 2010.
- Tingley, M. P., P. F. Craigmile, M. Haran, B. Li, E. Mannshardt, and B. Rajaratnam, Piecing together the past: statistical insights into paleoclimatic reconstructions, *Quaternary Science Reviews*, *35*, 1–22, doi:[10.1016/j.quascirev.2012.01.012](https://doi.org/10.1016/j.quascirev.2012.01.012), 2012.
- Tziperman, E., L. Stone, M. A. Cane, and H. Jarosh, El-Niño chaos: Overlapping of resonances between the seasonal cycle and the pacific ocean-atmosphere oscillator, *Science*, *264*, 72–74, doi:[10.1126/science.264.5155.72](https://doi.org/10.1126/science.264.5155.72), 1994.
- Tziperman, E., M. E. Raymo, P. Huybers, and C. Wunsch, Consequences of pacing the Pleistocene 100 kyr ice ages by nonlinear phase locking to Milankovitch forcing, *Paleoceanography*, *21*, PA4206, doi:[10.1029/2005PA001241](https://doi.org/10.1029/2005PA001241), 2006.

- Urban, N. M., and T. E. Fricker, A comparison of latin hypercube and grid ensemble designs for the multivariate emulation of an earth system model, *Computers & Geosciences*, 36(6), 746–755, doi:[10.1016/j.cageo.2009.11.004](https://doi.org/10.1016/j.cageo.2009.11.004), 2010.
- Voss, H. U., J. Timmer, and J. Kurths, Nonlinear dynamical system identification from uncertain and indirect measurements, *International Journal of Bifurcation and Chaos*, 14(6), 1905–1933, doi:[10.1142/S0218127404010345](https://doi.org/10.1142/S0218127404010345), 2004.
- Wilkinson, R. D., Bayesian calibration of expensive multivariate computer experiments, in *Large-Scale Inverse Problems and Quantification of Uncertainty*, edited by L. Biegler, G. Biros, O. Ghattas, M. Heinkenschloss, D. Keyes, B. Mallick, Y. Marzouk, L. Tenorio, B. van Bloemen Waanders, and K. Willcox, pp. 195–215, John Wiley & Sons, Ltd, Chichester, UK., doi:[10.1002/9780470685853.ch10](https://doi.org/10.1002/9780470685853.ch10), 2010.
- Wilson, D. R., A. C. Bushell, A. M. Kerr-Munslow, J. D. Price, C. J. Morcrette, and A. Bodas-Salcedo, PC2: A prognostic cloud fraction and condensation scheme. ii: Climate model simulations, *Quarterly Journal of the Royal Meteorological Society*, 134(637), 2109–2125, doi:[10.1002/qj.332](https://doi.org/10.1002/qj.332), 2008.
- Winsberg, E., Sanctioning models: The epistemology of simulation, *Science in Context*, 12(02), 275–292, doi:[10.1017/S0269889700003422](https://doi.org/10.1017/S0269889700003422), 1999.
- Winton, M., and E. S. Sarachik, Thermohaline oscillations induced by strong steady salinity forcing of ocean general circulation models, *Journal of Physical Oceanography*, 23(7), 1389–1410, doi:[10.1175/1520-0485\(1993\)023<1389:TOIBSS>2.0.CO;2](https://doi.org/10.1175/1520-0485(1993)023<1389:TOIBSS>2.0.CO;2), 1993.
- Wunsch, C., *Discrete Inverse and State Estimation Problems: With Geophysical Fluid Applications*, Cambridge University Press, Cambridge, UK, 2006.
- Yin, Q., A. Berger, E. Driesschaert, H. Goosse, M. F. Loutre, and M. Crucifix, The Eurasian ice sheet reinforces the east asian summer monsoon during the interglacial 500 000 years ago, *Climate of the Past*, 4(2), 79–90, doi:[10.5194/cp-4-79-2008](https://doi.org/10.5194/cp-4-79-2008), 2008.
- Young, P., and M. Ratto, A unified approach to environmental systems modeling, *Stochastic Environmental Research and Risk Assessment*, 23(7), 1037–1057, doi:[10.1007/s00477-008-0271-1](https://doi.org/10.1007/s00477-008-0271-1), 2009.
- Young, P. C., and M. Ratto, Statistical emulation of large linear dynamic models, *Technometrics*, 53(1), 29–43, doi:[10.1198/TECH.2010.07151](https://doi.org/10.1198/TECH.2010.07151), 2011.
- Zhao, Y., et al., A multi-model analysis of the role of the ocean on the African and Indian monsoon during the mid-Holocene, *Climate Dynamics*, 25, 777–800, doi:[10.1007/s00382-005-0075-7](https://doi.org/10.1007/s00382-005-0075-7), 2005.