

ANNULUS TWIST AND DIFFEOMORPHIC 4-MANIFOLDS

TETSUYA ABE, IN DAE JONG, YUKA OMAE, AND MASANORI TAKEUCHI

ABSTRACT. We give a method for obtaining infinitely many framed knots which represent a diffeomorphic 4-manifold. We also study a relationship between the n -shake genus and the 4-ball genus of a knot. Furthermore we give a construction of homotopy 4-spheres from a slice knot with unknotting number one.

1. INTRODUCTION

In Kirby's problem list [13], Clark asked the following.

Problem 1.1 ([13, Problem 3.6 (D)]). *Is there a 3-manifold which can be obtained by n -surgery on infinitely many mutually distinct knots?*

There are many related studies on Problem 1.1 (e.g., see [6], [10], [17], [18], [24]). In 2006, Osoinach [20] proved that there exists a hyperbolic 3-manifold which is obtained by 0-surgery on infinitely many mutually distinct knots. He also constructed such a toroidal 3-manifold. In particular, he solved Problem 1.1 for $n = 0$. The key tool to produce infinitely many (mutually distinct) knots was an operation which we will call an annulus twist. By the same method, Teragaito [23] proved that there exists a Seifert fibered 3-manifold which is obtained by 4-surgery on infinitely many mutually distinct knots. In particular, he solved Problem 1.1 for $n = 4$. It is known that Problem 1.1 is true for $n = 4m$ ($m \in \mathbb{Z}$) by Kouno [14]. For a recent study, see [21].

For a knot K in the 3-sphere $S^3 = \partial D^4$ and $n \in \mathbb{Z}$, we denote by $M_K(n)$ the 3-manifold obtained by n -surgery on K and by $X_K(n)$ the smooth 4-manifold obtained from the 4-ball D^4 by attaching a 2-handle along K with framing n . Note that $\partial X_K(n) \approx M_K(n)$, where we use the notation " $X \approx Y$ " when two manifolds X and Y are diffeomorphic. As a 4-dimensional analogue of Problem 1.1, the following is natural to ask.

Problem 1.2. *Let n be an integer. Find infinitely many mutually distinct knots K_1, K_2, \dots such that $X_{K_i}(n) \approx X_{K_j}(n)$ for each $i, j \in \mathbb{N}$.*

Currently less is known about Problem 1.2. We review known results on Problem 1.2. Due to Akbulut [3, 4], there exists a pair of distinct knots K_n and K'_n such that $X_{K_n}(n) \approx X_{K'_n}(n)$ for each $n \in \mathbb{Z}$. After Akbulut's works, the fourth author [22] solved Problem 1.2 for $n = 4$. Indeed, let K_1, K_2, \dots be the knots constructed by Teragaito in [23]. Then $\partial X_{K_i}(4) \approx$

Key words and phrases. Annulus twist; Band presentation; Carving; Dehn surgery; Kirby calculus; Homotopy 4-ball; Slice knot; Unknotting number one knot.

The first author was partially supported by KAKENHI, Grant-in-Aid for Research Activity start-up (No. 00614009), Japan Society for the Promotion of Science.

$\partial X_{K_j}(4)$ for each $i, j \in \mathbb{N}$. The fourth author proved that a diffeomorphism $f : \partial X_{K_i}(4) \rightarrow \partial X_{K_j}(4)$ extends to a diffeomorphism $\tilde{f} : X_{K_i}(4) \rightarrow X_{K_j}(4)$ such that $\tilde{f}|_{\partial X_{K_i}(4)} = f$ using carving techniques (Lemma 2.9) introduced by Akbulut in [4]. Subsequently, the third author [19] solved Problem 1.2 for $n = 0$.

In this paper, we generalize these results and give a framework to solve Problem 1.2 for $n = 0$ or ± 4 . To state our main theorem, we introduce a band presentation of a knot as follows: Let $A \subset \mathbb{R}^2 \cup \{\infty\} \subset S^3$ be a standardly embedded annulus with a ε -framed unknot c in S^3 as shown in the left side of Figure 1, where $\varepsilon = \pm 1$. Take an embedding of a band $b : I \times I \rightarrow S^3$ such that

- $b(I \times I) \cap \partial A = b(\partial I \times I)$,
- $b(I \times I) \cap \text{int} A$ consists of ribbon singularities, and
- $b(I \times I) \cap c = \emptyset$,

where $I = [0, 1]$. If a knot K is equivalent to the knot $(\partial A \setminus b(\partial I \times I)) \cup b(I \times \partial I)$ in $M_c(\varepsilon)$, then we say that K admits a *band presentation* (A, b, c, ε) ¹. Note that $M_c(\varepsilon) \approx S^3$. A typical example of a band presentation of a knot is given in Figure 1.

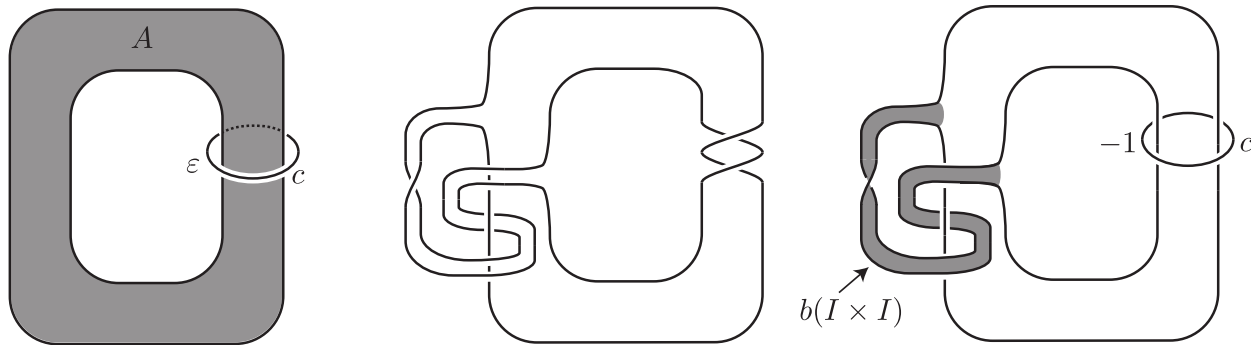

FIGURE 1. The knot depicted in the center admits a band presentation as shown in the right side.

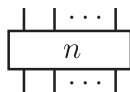

FIGURE 2. n times right (resp. left)-handed full twists for $n > 0$ (resp. $n < 0$).

We explain how to obtain infinitely many knots from a knot admitting a band presentation. We represent n times full twists by the rectangle labelled n as shown in Figure 2. For any knot K admitting a band presentation, we can find an annulus A' and twist the knot along A' as shown in Figure 3. The resulting knot is called the knot obtained from K by applying an annulus twist. Similarly, we define the knot obtained from K by applying an annulus twist n times. For precisely, see Subsection 2.2. Note that, for a knot admitting a band

¹Winter [26] also introduced the notion of a band presentation in the study of ribbon 2-knots. A band presentation introduced in the current paper is different from Winter's one.

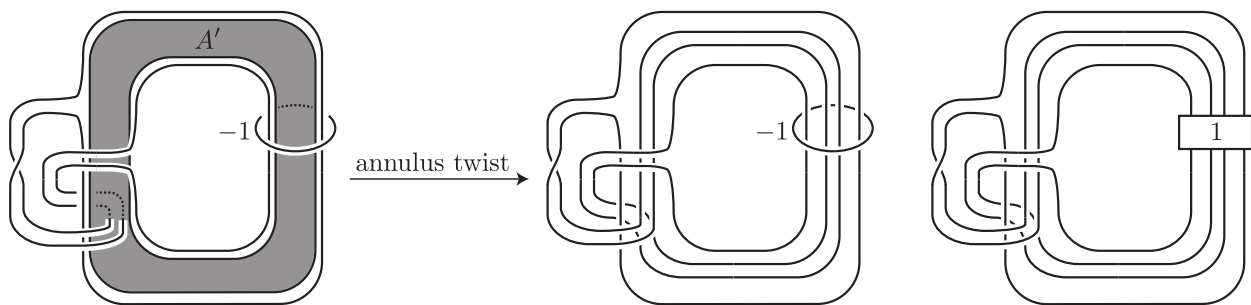

FIGURE 3. The associated annulus A' , an annulus twist, and the resulting knot.

presentation, we can associate a framing (called the induced framing) in a natural way (see Subsection 2.1). Our main result is the following.

Theorem 2.8. *Let K be a knot admitting a band presentation, K_n the knot obtained from K by applying an annulus twist n times for $n \in \mathbb{Z}$. Then $X_K(\gamma) \approx X_{K_n}(\gamma)$, where γ is the induced framing from the band presentation.*

The key to prove Theorem 2.8 is also carving techniques introduced in [4]. We note that Theorem 2.8 gives a general answer to [5, Excerise 15]. As a corollary of Theorem 2.8, we obtain the following.

Corollary 2.10. *For each $\gamma \in \{0, \pm 4\}$, there exist infinitely many mutually distinct knots K_1, K_2, \dots such that $X_{K_i}(\gamma) \approx X_{K_j}(\gamma)$ for each $i, j \in \mathbb{N}$.*

It is important to ask which knot admits a band presentation. The set of knots admitting band presentations contains all unknotting number one knots (Lemma 2.2). Thus the set is relatively large in this sense. Furthermore this observation enables us to construct homotopically slice knots and homotopy 4-spheres from a slice knot with unknotting number one (Proposition 3.4).

In studies on smooth structures of a 4-manifold, Akbulut [4] introduced the n -shake genus $g_s^n(K)$ of a knot K , which is defined as the minimal genera of closed smooth surfaces in $X_K(n)$ such that the homology class of each closed surface generates $H_2(X_K(n))$.

In this paper, we also study a relationship between the n -shake genus $g_s^n(K)$ and the 4-ball genus $g_*(K)$ of a knot K . It is easy to see that $g_s^n(K) \leq g_*(K)$. Akbulut and Kirby [13, Problem 1.41 (A)] asked whether $g_s^0(K) = g_*(K)$, and noted that these probably do not coincide. One of our motivations is to find a knot K with $g_s^0(K) < g_*(K)$. The following is an immediate consequence of Theorem 2.8.

Corollary 3.1. *Let K be a knot with a band presentation whose induced framing is 0, K_n the knot obtained from K by applying an annulus twist n times. Then, for each $i, j \in \mathbb{Z}$,*

$$g_s^0(K_i) = g_s^0(K_j).$$

With the notation of Corollary 3.1, if $g_*(K) \neq g_*(K_n)$ for some $n \in \mathbb{Z}$, then we see that $g_s^0(K_n) < g_*(K_n)$. However, according to some observations we would propose the following.

Conjecture 3.5. *Let K be a knot with a band presentation whose induced framing is 0, and K_n the knot obtained from K by applying an annulus twists n times. Then $g_*(K) = g_*(K_n)$.*

We note that the situation is entirely different for the n -shake genus with $n \neq 0$. In fact, Akbulut [3, 4] and the third author [19] gave a knot K such that $g_s^n(K) < g_*(K)$ for each $n \neq 0$ (see also [16]). We give infinitely many such knots as follows.

Corollary 3.7. *For each integer $n \neq 0$, there exist infinitely many knots K_1, K_2, \dots such that $g_s^n(K_i) < g_*(K_i)$ for any $i \in \mathbb{N}$.*

Acknowledgments. The authors would like to express their gratitude to Hisaaki Endo, Motoo Tange, and Kouichi Yasui for teaching them about 4-manifold theory. They also would like to thank Masakazu Teragaito for his useful comments, and Makoto Sakuma for suggesting the fact in Remark 3.12. They also thank the referee for careful reading of our draft and useful suggestions.

2. CONSTRUCTION OF DIFFEOMORPHIC 4-MANIFOLDS

In this section, we give a method for obtaining a family of framed knots such that each represents the same 4-manifold up to diffeomorphism.

2.1. Band presentation. We study some properties of a band presentation. Let K be a knot admitting a band presentation (A, b, c, ε) . Note that the boundary of the (immersed) surface $A \cup b(I \times I)$ is K in $M_c(\varepsilon) \approx S^3$. Thus we can regard K as a framed knot by using the surface $A \cup b(I \times I)$ in $M_c(\varepsilon) \approx S^3$ and call it the *induced framing* from the band presentation. The induced framing from the band presentation is 0 if $A \cup b(I \times I)$ is orientable, ± 4 if $A \cup b(I \times I)$ is non-orientable and $\varepsilon = \mp 1$. Here we give examples of band presentations.

Example 2.1. Let J_m ($m \in \mathbb{Z}$) be the knot depicted in the upper half of Figure 4. Then we see that J_m admits a band presentation as shown in the left side of the lower half of Figure 4. The induced framing from this band presentation is 0 if m is odd, otherwise it is 4. Note that a band presentation of a given knot may not be unique. For example, J_m also admits a band presentation as shown in the right side of the lower half of Figure 4. In this case, the induced framing is 0 if $m - 1$ is odd, otherwise it is -4 . Teragaito [23] and the fourth author [22] studied the knot J_2 and the third author [19] studied the knot J_1 respectively.

It is easy to see that the unknotting number of J_m is one. This fact is generalized as follows.

Lemma 2.2. *Let K be a knot. If the unknotting number of K is less than or equal to one, then K admits a band presentation.*

Proof. By the assumption, there exists a crossing of a diagram of K such that changing the crossing yields the unknot. Adding a band near the crossing as shown in the left side of Figure 5, we obtain a Hopf link which bounds a (twisted) annulus. Then we see that K admits a band presentation. \square

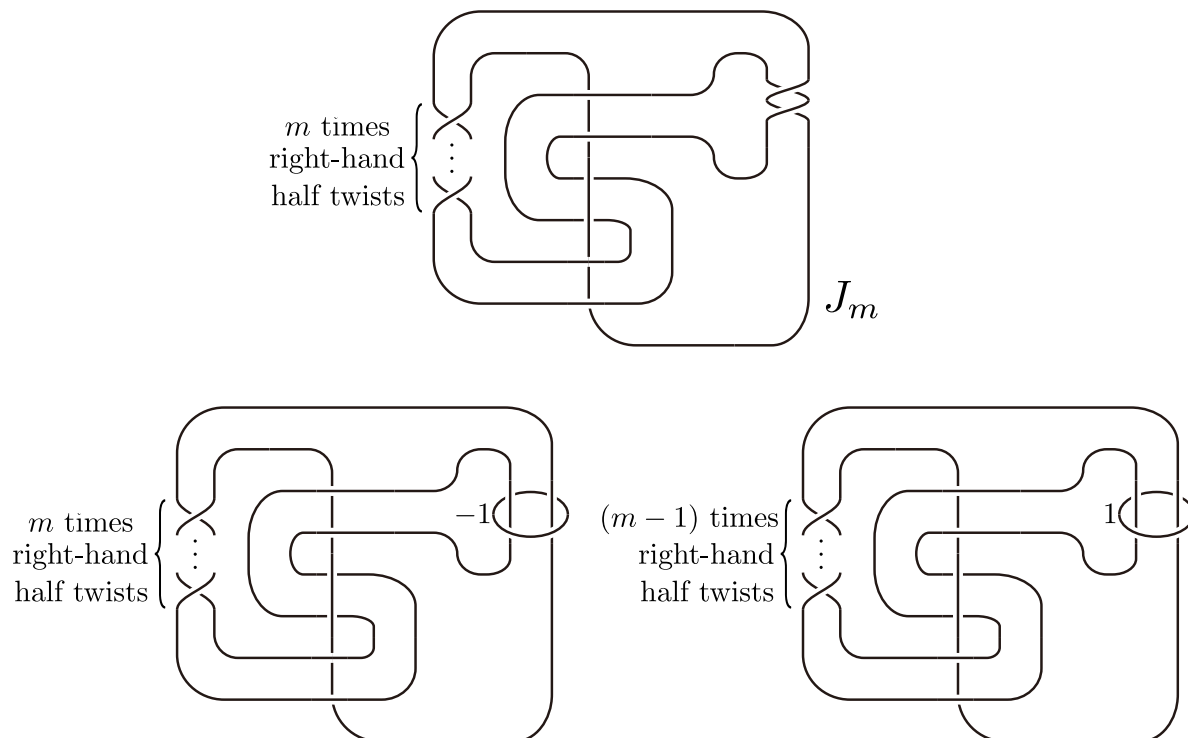
FIGURE 4. The knot J_m and its band presentations.

Remark 2.3. We note that the set of knots admitting a band presentation is equal to the set of knots obtained from the Hopf link applying a band surgery. For studies on a band surgery, see [1, 2] for example.



FIGURE 5.

2.2. Annulus twist. Using an annulus twist, Osoinach [20] constructed infinitely many knots such that each knot yields the same 3-manifold by 0-surgery. Let A be a standardly embedded annulus in S^3 and set $\partial A = c_1 \cup c_2$. An *annulus twist along A* is to apply Dehn surgery on c_1 and c_2 along slopes 1 and -1 respectively, which yields a diffeomorphism $\varphi : S^3 \setminus \nu\partial A \rightarrow S^3 \setminus \nu\partial A$, where $\nu\partial A$ is an open tubular neighborhood of ∂A in S^3 . In the case where the slope of c_1 is -1 and that of c_2 is 1, it is described as the diffeomorphism φ^{-1} . In general, the surgery on c_1 and c_2 along slopes $1/n$ and $-1/n$ for $n \in \mathbb{Z}$ is described as the diffeomorphism φ^n , that is, twisting n times.

As mentioned in Section 1, for a given knot with a band presentation, we can construct infinitely many knots. Here we explain this process precisely. Let K be a knot admitting a band presentation (A, b, c, ε) . Shrinking the annulus A slightly, we obtain an annulus $A' \subset A$ as shown in Figure 3. We call A' the *associated annulus* of A . Applying an annulus twist n times along A' , we obtain a knot $K_n \subset S^3$ with a band presentation (A, b_n, c, ε) , where b_n is the obvious one. Note that the induced framing of (A, b_n, c, ε) coincides with that of (A, b, c, ε) . We call K_n the knot obtained from K by applying an annulus twist n times without mentioning the associated annulus A' .

Remark 2.4. $K_{n+m} = (K_n)_m$ for $n, m \in \mathbb{Z}$.

The following proposition follows from [20, Theorem 2.3].

Proposition 2.5. *Let K be a knot with a band presentation, K_n the knot obtained from K by applying an annulus twist n times. Then $M_K(\gamma) \approx M_{K_n}(\gamma)$, where γ is the induced framing from the band presentation.*

Remark 2.6. Let K_1, K_2, \dots be knots such that $M_{K_i}(0) \approx M_{K_j}(0)$ for each $i, j \in \mathbb{N}$. Then the Alexander modules of K_i and K_j are isomorphic. In particular, we have $\Delta_{K_i}(t) = \Delta_{K_j}(t)$ and $\sigma(K_i) = \sigma(K_j)$. Here $\Delta_K(t)$ denotes the Alexander polynomial and $\sigma(K)$ denotes the signature of a knot K . Therefore it is not easy to distinguish K_i and K_j .

Remark 2.7. In the definition of a band presentation, the annulus A is not necessary to be unknotted. In fact, the argument in this subsection holds for a band presentation with a knotted embedded annulus in S^3 .

2.3. Main theorem. In this subsection, we prove the main theorem.

Theorem 2.8. *Let K be a knot admitting a band presentation, K_n the knot obtained from K by applying an annulus twist n times for $n \in \mathbb{Z}$. Then $X_K(\gamma) \approx X_{K_n}(\gamma)$, where γ is the induced framing from the band presentation.*

We briefly explain the proof of Theorem 2.8. Let K be a knot with a band presentation, K' the knot obtained from K by applying an annulus twist, and γ the induced framing from the band presentation. First, we give a diffeomorphism $f : \partial X_K(\gamma) \rightarrow \partial X_{K'}(\gamma)$ by Kirby calculus (as explained in [23]). The problem is whether f extends to a diffeomorphism $\tilde{f} : X_K(\gamma) \rightarrow X_{K'}(\gamma)$ such that $\tilde{f}|_{\partial X_K(\gamma)} = f$. Akbulut [4] introduced a sufficient condition for f to be extended to \tilde{f} (Lemma 2.9) using Cerf's theorem which states that any self-diffeomorphism of S^3 extends over D^4 (e.g. see [7]). (A general sufficient condition is shown in [5].) We can check that f satisfies the condition, proving Theorem 2.8. Here we recall this sufficient condition and give a proof for the sake of the readers.

Lemma 2.9 ([4]). *Let K and K' be knots in $S^3 = \partial D^4$ with a diffeomorphism $g : \partial X_K(n) \rightarrow \partial X_{K'}(n)$, and let μ be a meridian of K . Suppose that if μ is 0-framed, then $g(\mu)$ is the 0-framed unknot in the Kirby diagram representing $X_{K'}(n)$. If the Kirby diagram which consists of the 2-handle represented by K' with framing n and the 1-handle represented by (dotted) $g(\mu)$ represents D^4 , then g extends to a diffeomorphism $\tilde{g} : X_K(n) \rightarrow X_{K'}(n)$ such that $\tilde{g}|_{\partial X_K(n)} = g$.*

Proof. Since μ and $g(\mu)$ are unknotted, these bound obvious properly embedded disks in D^4 , D_1 and D_2 respectively. Let $\nu\mu$ be an open tubular neighborhood of μ in $S^3 = \partial D^4$. Let νD_i be an open tubular neighborhood of D_i in D^4 . Since the framing of $g(\mu)$ is 0 if we assume that μ is 0-framed, $g|_{\nu\mu}$ extends to a diffeomorphism $g' : \overline{\nu D_1} \rightarrow \overline{\nu D_2}$. Now $X_K(n) \setminus \nu D_1$ is diffeomorphic to D^4 and by the assumption $X_{K'}(n) \setminus \nu D_2$ is also diffeomorphic to D^4 . Therefore g extends to a diffeomorphism $\tilde{g} : X_K(n) \rightarrow X_{K'}(n)$ such that $\tilde{g}|_{\partial X_K(n)} = g$. \square

Now we start the proof of Theorem 2.8.

Proof of Theorem 2.8. Let (A, b, c, ε) be a band presentation of K and γ the induced framing. The proof is divided into four cases.

Case 1. $\varepsilon = 1$ and $\gamma = 0$.

First, we consider the case where $K = J_2$ with the band presentation $(A, b, c, 1)$ depicted in the right side of Figure 4. Then the induced framing γ is 0. Figure 6 illustrates a diffeomorphism from $\partial X_{K_{n+1}}(0)$ to $\partial X_{K_n}(0)$ for an integer n . To see this, recall that $K_{n+1} = (K_n)_1$ as noted in Remark 2.4, and ignore the meridian μ of K_{n+1} for a while, which is illustrated by a broken circle in Figure 6. The first Kirby diagram in Figure 6 is obtained from $X_{K_{n+1}}(0)$ by a blow-up. Sliding the -1 -framed unknot to the 0 -framed K_n , we obtain the second Kirby diagram. Applying an annulus twist, we obtain the third Kirby diagram. After an ambient isotopy and a blow-down, we obtain the 0 -framed K_n which represents $X_{K_n}(0)$. This Kirby calculus induces a diffeomorphism from $\partial X_{K_{n+1}}(0)$ to $\partial X_{K_n}(0)$ and we denote it by f_{n+1} .

Remember the meridian μ of K_{n+1} . We can check that $f_{n+1}(\mu)$ is the 0 -framed unknot in the Kirby diagram of $X_{K_n}(0)$ if μ is 0 -framed. Let W be the 4 -manifold $D^4 \cup h^1 \cup h^2$, where h^1 is the 1 -handle represented by $f_{n+1}(\mu)$ with a dot and h^2 is the 2 -handle represented by K_n with framing 0 . Sliding h^2 over h^1 , we obtain a canceling pair (see Figure 7), implying that $W \approx D^4$. By Lemma 2.9, $X_{K_{n+1}}(0) \approx X_{K_n}(0)$, proving Theorem 2.8 in the case where $K = J_2$ with the band presentation.

Furthermore we see that the above argument can be applied to any knot admitting a band presentation with $\varepsilon = 1$ and $\gamma = 0$ since all of a blow-up, a blow-down, handle slides, and isotopies in Figures 6 and 7 were done in a neighborhood of the annulus A . Now we have completed the proof for Case 1.

Case 2. $\varepsilon = 1$ and $\gamma = -4$.

In this case, we can prove similarly as Case 1 since the induced framing $\gamma = -4$ changed to 0 when we apply a blow-up as shown in Figure 8.

Case 3. $\varepsilon = -1$ and $\gamma = 0$.

In this case, the argument is similar to that for Case 1. The difference is that we consider a diffeomorphism from $\partial X_{K_{n-1}}(0)$ to $\partial X_{K_n}(0)$.

First, we consider the case where $K = J_1$ with the band presentation $(A, b, c, -1)$ depicted in the left side of Figure 4. Then the induced framing is 0 . Figure 9 illustrates a diffeomorphism from $\partial X_{K_{n-1}}(0)$ to $\partial X_{K_n}(0)$ for an integer n . To see this, recall that $K_{n-1} = (K_n)_{-1}$

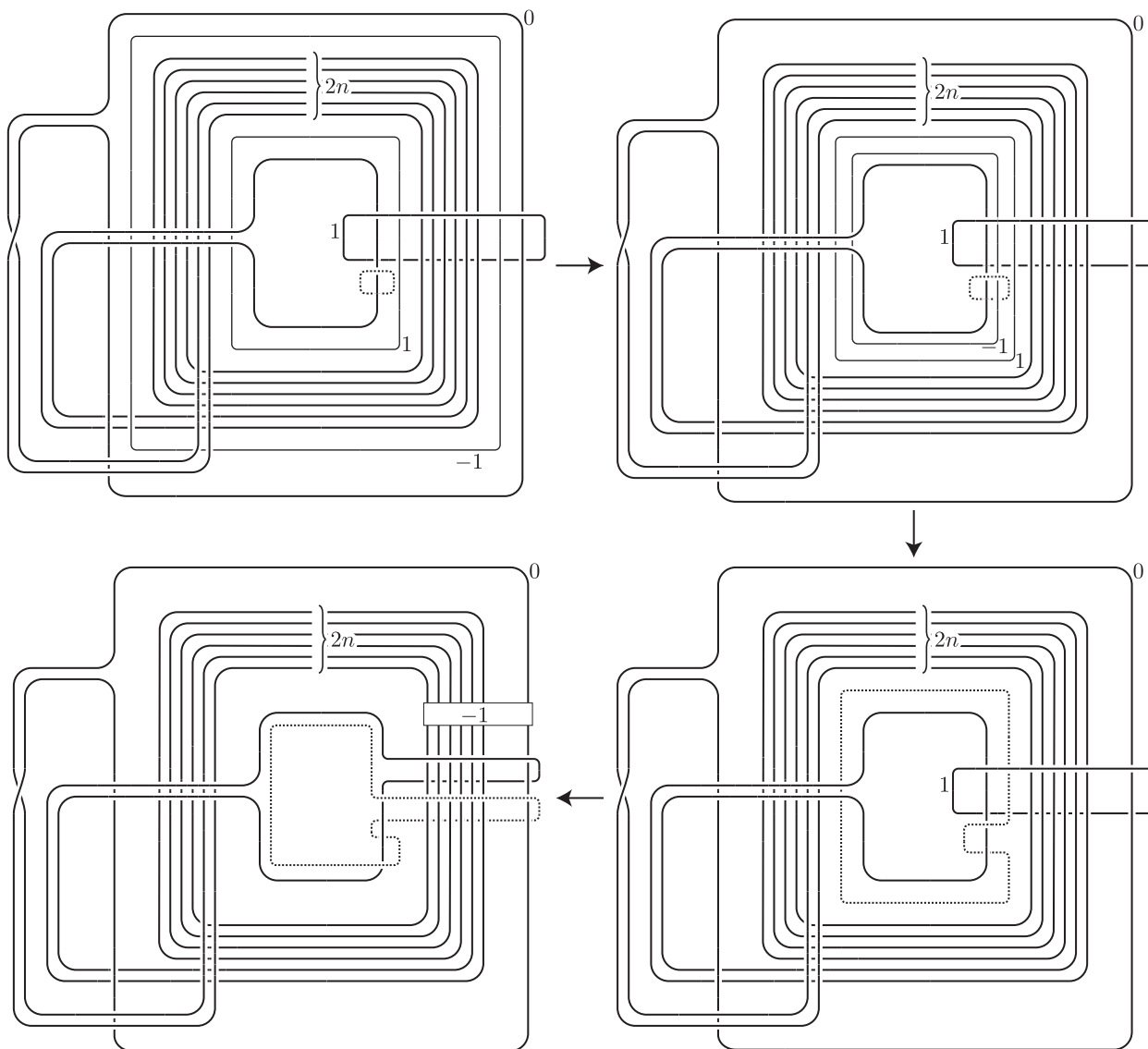

FIGURE 6. Kirby diagrams representing a diffeomorphism $f_{n+1} : \partial X_{K_{n+1}}(0) \rightarrow \partial X_{K_n}(0)$.

as noted in Remark 2.4, and ignore the meridian μ' of K_{n-1} for a while, which is illustrated by a broken circle in Figure 9. The first Kirby diagram in Figure 9 is obtained from $X_{K_{n-1}}(0)$ by a blow-up. Sliding the 1-framed unknot to the 0-framed K_n , we obtain the second Kirby diagram. Applying an annulus twist, we obtain the third Kirby diagram. After an ambient isotopy and a blow-down, we obtain the 0-framed K_n which represents $X_{K_n}(0)$. This Kirby calculus induces a diffeomorphism from $\partial X_{K_{n-1}}(0)$ to $\partial X_{K_n}(0)$ and we denote it by f'_{n-1} .

Remember the meridian μ' of K_{n-1} . We can check that $f'_{n-1}(\mu')$ is the 0-framed unknot in the Kirby diagram of $X_{K_n}(0)$ if μ' is 0-framed. Let W' be the 4-manifold $D^4 \cup h^1 \cup h^2$, where h^1 is the 1-handle represented by $f'_{n-1}(\mu')$ with a dot and h^2 is the 2-handle represented by K_n with framing 0. Sliding h^2 over h^1 , we obtain a canceling pair (see Figure 10), implying

FIGURE 7. $W \approx D^4$.

FIGURE 8.

that $W' \approx D^4$. By Lemma 2.9, $X_{K_{n-1}}(0) \approx X_{K_n}(0)$, proving Theorem 2.8 in the case where $K = J_1$ with the band presentation.

Furthermore we see that the above argument can be applied to any knot admitting a band presentation with $\varepsilon = -1$ and $\gamma = 0$ since all of a blow-up, a blow-down, handle slides, and isotopies in Figures 9 and 10 were done in the neighborhood of the annulus A . Now we have completed the proof for Case 3.

Case 4. $\varepsilon = -1$ and $\gamma = 4$.

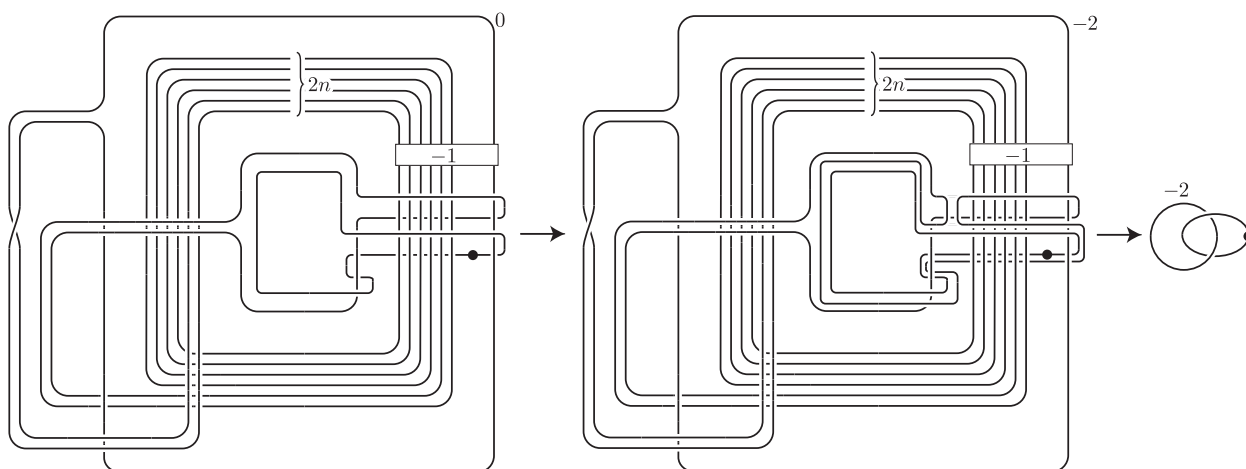
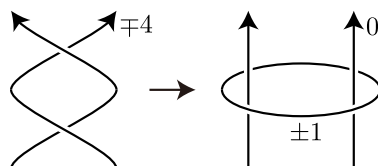
In this case, we can prove similarly as Case 3 since the framing $\gamma = 4$ changed to 0 when we apply a blow-up as shown in Figure 8.

Now we have completed the proof of Theorem 2.8. □

Let K be a knot with a band presentation (A, b, c, ε) , A' the associated annulus of A , and set $\partial A' = c_1 \cup c_2$. The *augmented 3-component link* L associated to the band presentation is the link $(\partial A \setminus b(\partial I \times I)) \cup b(I \times \partial I) \cup c_1 \cup c_2$ in $M_\varepsilon(c) \approx S^3$ and denote it by $L = K \cup c_1 \cup c_2$.

Corollary 2.10. *For each $\gamma \in \{0, \pm 4\}$, there exist infinitely many mutually distinct knots K_1, K_2, \dots such that $X_{K_i}(\gamma) \approx X_{K_j}(\gamma)$ for each $i, j \in \mathbb{N}$.*

Proof. Let J_m be the knot introduced in Example 2.1. First we prove Corollary 2.10 for $\gamma = \pm 4$. Consider the band presentation of J_m depicted in the left (resp. right) side of the lower half of Figure 4. Assume that m is even (resp. odd). Then the induced framing γ is 4 (resp. $\gamma = -4$). Let $L = J_m \cup c_1 \cup c_2$ be the augmented 3-component link associated to the

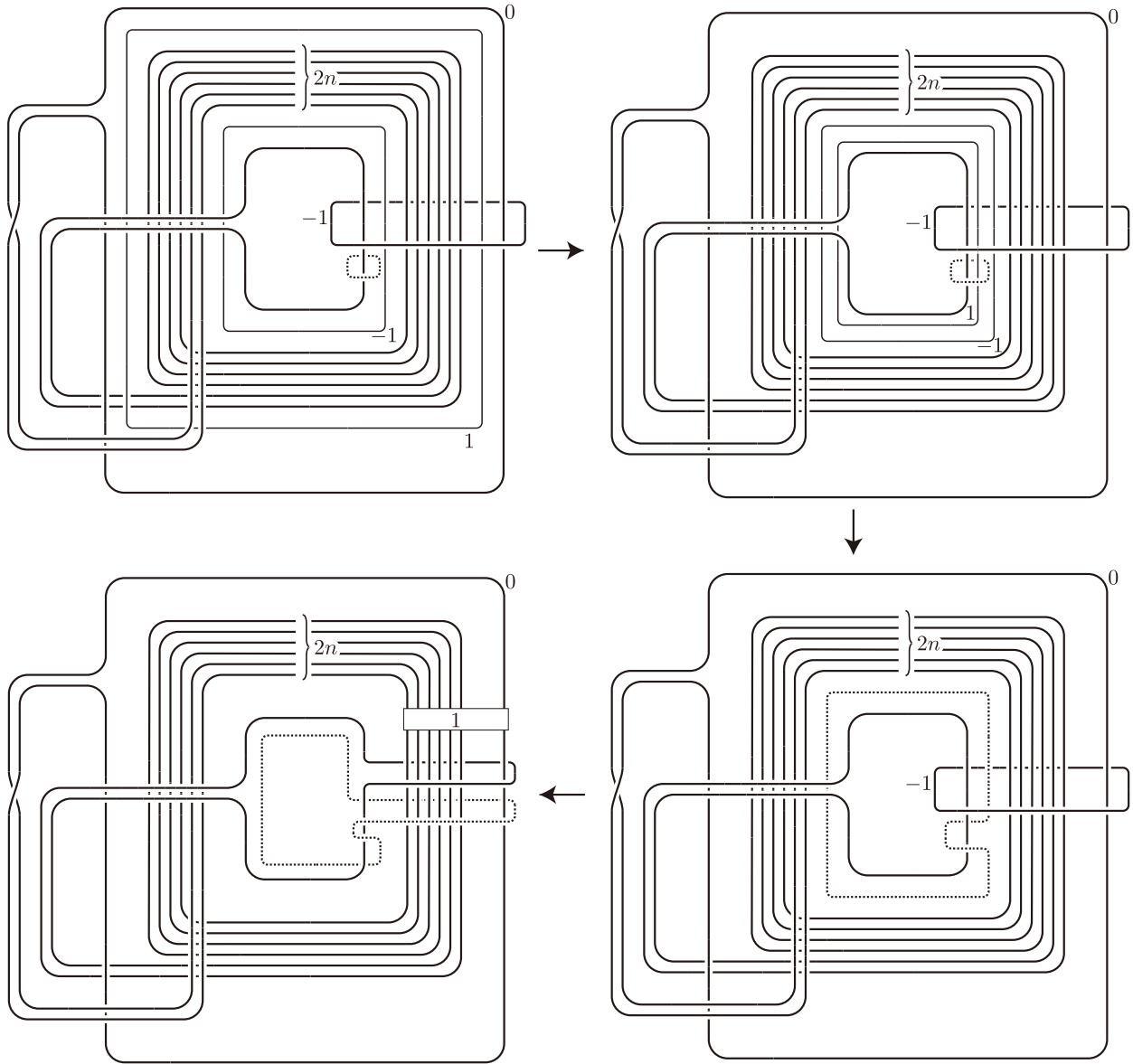

FIGURE 9. Kirby diagrams representing a diffeomorphism $f_{n-1} : \partial X_{K_{n-1}}(0) \rightarrow \partial X_{K_n}(0)$.

band presentation as shown in Figure 11. Then L admits the tangle decomposition as shown in Figure 12. Since this decomposition is same as that in [23, Section 3], L is hyperbolic by [23, Proposition 3.2]. Let K_n be the knot obtained from J_m by applying an annulus twist n times. The knot complement $S^3 - K_n$ is obtained from $S^3 - L$ by $(1 + 1/n)$ -filling on c_1 and $(1 - 1/n)$ -filling on c_2 . By Thurston's hyperbolic Dehn surgery theorem, $S^3 - K_n$ is hyperbolic for any large enough n . Furthermore, the volume of $S^3 - K_n$ monotonically increases to the volume of $S^3 - L$ for any large enough n [15]. Since the volume is a knot invariant, there exists a natural number N such that K_i and K_j are mutually distinct for each $i, j \geq N$. Finally, we redefine K_n as the knot K_{N+n} . Then these knots are mutually

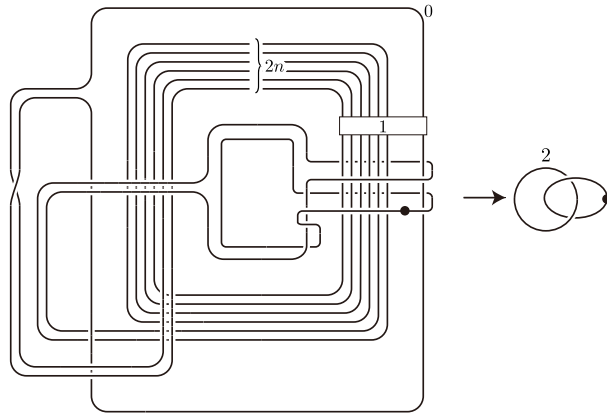

FIGURE 10. $W' \approx D^4$.

distinct and $X_{K_i}(\gamma) \approx X_{K_j}(\gamma)$ for each $i, j \in \mathbb{N}$. Now we have completed the proof for the case where $\gamma = \pm 4$.

Next we give the proof for the case where $\gamma = 0$. Consider the band presentation of J_m depicted in the left side of the lower half of Figure 4, and assume that m is odd. Then the induced framing γ is 0. In this case, the augmented 3-component link L admits the tangle decomposition as shown in Figure 13. The difference of Figures 12 and 13 is just glueing labels. In this case, we can easily check that the Conway polynomial of L is non-zero. Thus L is not a split link, and the exterior $E(L)$ is irreducible. We can also see that $E(L)$ is atoroidal and not Seifert fibered by the same argument in the proof of [23, Proposition 3.2]. Therefore L is also hyperbolic in this case, and then the remaining proof is achieved by the same argument as the case where $\gamma = \pm 4$. Now we have completed the proof of Corollary 2.10. \square

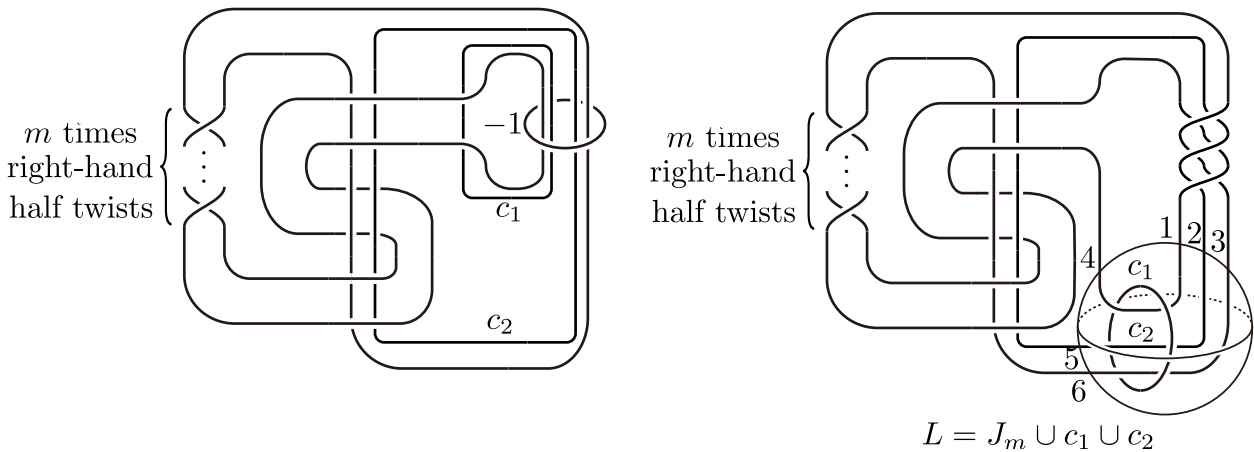
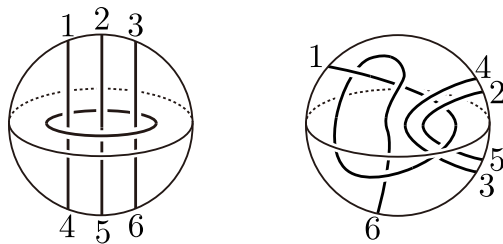
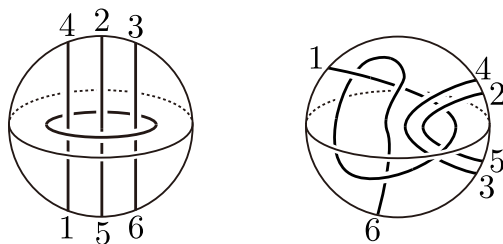

FIGURE 11. The augmented 3-component link.

Remark 2.11. Here recall that a given knot J is fibered if and only if $M_J(0)$ is a surface bundle over S^1 [9, Corollary 8.19]. Since J_1 is fibered, the knots obtained from J_1 by

FIGURE 12. Tangle decomposition in the case $\gamma = \pm 4$.FIGURE 13. Tangle decomposition in the case $\gamma = 0$.

applying annulus twists are fibered and these genera are two. In this case, the genus does not distinguish these knots. On the other hand, though J_2 is fibered, it is not obvious whether the knot K_n obtained from J_2 by applying an annulus twist n times is fibered. In [22], the fourth author proved that K_n ($n \in \mathbb{N}$) is a fibered knot by studying the complementary sutured manifold of K_n , and showed that the genus of K_n is $2n + 2$. Therefore the genus distinguishes the knots K_n .

3. THE n -SHAKE GENUS AND THE 4-BALL GENUS

In this section, we study a relationship between the n -shake genus and the 4-ball genus of a knot.

3.1. The shake genus. In this subsection, we focus on the 0-shake genus. We simply call the 0-shake genus the *shake genus* of a knot K and we denote it by $g_s(K)$. Akbulut and Kirby [13, Problem 1.41 (A)] asked whether $g_s(K) = g_*(K)$ and noted that these probably do not coincide. One of our motivations is to find a knot K with $g_s(K) < g_*(K)$. The following is a corollary of Theorem 2.8.

Corollary 3.1. *Let K be a knot with a band presentation whose induced framing is 0, K_n the knot obtained from K by applying an annulus twist n times. Then, for each $i, j \in \mathbb{Z}$,*

$$g_s(K_i) = g_s(K_j).$$

In the following, we observe a property of knots constructed by annulus twists (Proposition 3.3). Recall that a knot $K \subset S^3$ is said to be *slice* if $g_*(K) = 0$. We say that a knot $K \subset S^3$ is *homotopically slice* if there exists a homotopy 4-ball W with $\partial W \approx S^3$ such that K bounds a smoothly embedded disk in W .

Lemma 3.2. *Let K and K' be knots such that $M_K(0) \approx M_{K'}(0)$. If K is slice, then K' is homotopically slice.*

Proof. Since K is slice, there exists a properly embedded disk D^2 in D^4 such that $\partial D^2 = K$ and let νD^2 be an open tubular neighborhood of D^2 in D^4 . Notice that $\partial(D^4 \setminus \nu D^2) \approx M_K(0)$. Let k be a diffeomorphism from $M_K(0)$ to $M_{K'}(0)$ and we regard $\partial(D^4 \setminus \nu D^2)$ as $M_{K'}(0)$ via k . In other words, we consider the 4-manifold

$$(M_{K'}(0) \times [-1, 1]) \cup_k (D^4 \setminus \nu D^2),$$

where $\partial(D^4 \setminus \nu D^2) \approx M_K(0)$ and $M_{K'}(0) \times \{-1\} \approx M_{K'}(0)$ are identified by k . Taking a meridian μ' of K' , add a 2-handle along $\mu' \subset M_{K'}(0) \approx M_{K'}(0) \times \{1\} = \partial((M_{K'}(0) \times [-1, 1]) \cup_k (D^4 \setminus \nu D^2))$ with the framing 0. We denote by W the resulting 4-manifold. Then we see that $\partial W \approx S^3$, and K' is isotopic to the boundary of the cocore disk of the 2-handle attached along μ' . Thus K' bounds the cocore disk in W , that is, a smoothly embedded disk in W .

We show that W is a homotopy 4-ball, i.e., $\pi_*(W) \simeq \pi_*(D^4)$. To prove this, we show that W is a homology 4-ball, i.e., $H_*(W) \simeq H_*(D^4)$, and $\pi_1(W)$ is trivial. First we prove that $H_*(W) \simeq H_*(D^4)$. We consider the inclusion map

$$i : (S^3 \setminus \nu K') \rightarrow (M_{K'}(0) \times [-1, 1]) \cup_k (D^4 \setminus \nu D^2),$$

where $\nu K'$ is an open tubular neighborhood of K' in S^3 . Then an elementary homological argument tells us that i_* is an isomorphism. Since $H_1(S^3 \setminus \nu K')$ is generated by μ' , $H_1((M_{K'}(0) \times [-1, 1]) \cup_k (D^4 \setminus \nu D^2))$ is also generated by μ' . Adding the 2-handle along μ' kills $H_1((M_{K'}(0) \times [-1, 1]) \cup_k (D^4 \setminus \nu D^2))$ and therefore W is a homology 4-ball.

Next, we prove that $\pi_1(W)$ is trivial. By considering a handle decomposition of $D^4 \setminus \nu D^2$, we obtain that $\pi_1(D^4 \setminus \nu D^2)$ is normally generated by a meridian μ of K . Therefore $\pi_1((M_{K'}(0) \times [-1, 1]) \cup_k (D^4 \setminus \nu D^2))$ is normally generated by μ' . By the van Kampen theorem, $\pi_1(W)$ is trivial. Since $H_*(W) \simeq H_*(D^4)$, W is a homotopy 4-ball. \square

By Proposition 2.5 and Lemma 3.2, we have the following.

Proposition 3.3. *Let K be a slice knot admitting a band presentation whose induced framing is 0 and K_n the knot obtained from K by applying an annulus twist n times. Then there exists a homotopy 4-ball W_n with $\partial W_n = S^3$ such that K_n bounds a smoothly embedded disk in W_n . In particular, we can associate a homotopy 4-sphere for each $n \in \mathbb{Z}$.*

By Lemma 2.2, an unknotting number one knot admits a band presentation. Furthermore we may assume that the induced framing of the band presentation is 0 as in Example 2.1. Therefore we have the following.

Proposition 3.4. *We can obtain homotopically slice knots and homotopy 4-spheres from a slice knot with unknotting number one.*

Let K be a knot with a band presentation such that the induced framing is 0, and K' the knot obtained from K by a single annulus twist. Then $g_s(K) = g_s(K')$ by Corollary 3.1. If

$g_*(K) \neq g_*(K')$, then we obtain an answer to Akbulut and Kirby’s problem. However, it seems that $g_*(K) = g_*(K')$ by the following observation.

First, since K can be transformed into the unknot by two band surgeries, we see that $g_*(K) \leq 1$. Suppose that K is slice. Then K' is homotopically slice by Lemma 3.2. If the smooth Poincaré conjecture in dimension four is true, then K' is slice, and then $g_*(K) = g_*(K') = 0$. Suppose that $g_*(K) = 1$. Then it is likely that $g_*(K') = 1$ since if K' is slice then K is homotopically slice by Lemma 3.2, which produce a counterexample for the smooth Poincaré conjecture in dimension four. Consequently, if the smooth Poincaré conjecture in dimension four is true, then $g_*(K) = g_*(K')$. Based on the above observations we propose the following.

Conjecture 3.5. *Let K be a knot with a band presentation whose induced framing is 0, and K_n the knot obtained from K by applying an annulus twists n times. Then $g_*(K) = g_*(K_n)$.*

3.2. The n -shake genus for $n \neq 0$. In this subsection, we consider the n -shake genus of a knot for $n \neq 0$. Let $K_{n,m}$ be the knot depicted in the left side of Figure 14, where the shaded rectangle labeled $2m + 1$ represents $2m + 1$ times left-hand half twists as shown in Figure 15. Note that $K_{n,m}$ is a generalization of knots in [3, 4], [16], and [19]. Then we have the following.

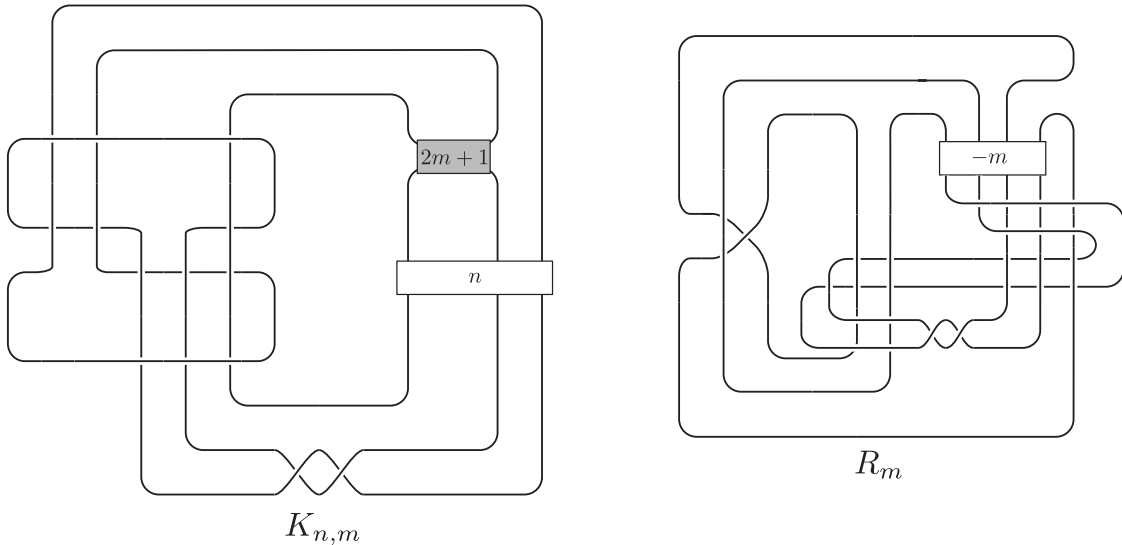

FIGURE 14. The knots $K_{n,m}$ and R_m .

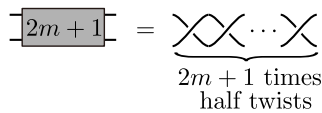

FIGURE 15.

Theorem 3.6. *For integers $n \neq 0$ and $m \geq 0$,*

$$g_s^n(K_{n,m}) = 0 \text{ and } g_*(K_{n,m}) = 1.$$

We obtain the following immediately as a corollary of Theorem 3.6.

Corollary 3.7. *For each integer $n \neq 0$, there exist infinitely many knots K_1, K_2, \dots such that $g_s^n(K_i) < g_*(K_i)$ for any $i \in \mathbb{N}$.*

To prove Theorem 3.6, we give two lemmas. We normalize the Alexander polynomial $\Delta_K(t)$ of a knot K so that $\Delta_K(t^{-1}) = \Delta_K(t)$ and $\Delta_K(1) = 1$.

Lemma 3.8. *Let n be a positive integer. Then for any $m \geq 0$,*

$$\begin{aligned} \Delta_{K_{n,m}}(t) = & -(1 + 6m) + (2 + 4m)(t + t^{-1}) - (1 + m)(t^2 + t^{-2}) + m(t^{n-2} + t^{-(n-2)}) \\ & - (1 + 3m)(t^{n-1} + t^{-(n-1)}) + (2 + 3m)(t^n + t^{-n}) - (1 + m)(t^{n+1} + t^{-(n+1)}) \end{aligned}$$

and

$$\begin{aligned} \Delta_{K_{-n,m}}(t) = & -(1 + 6m) + (2 + 4m)(t + t^{-1}) - (1 + m)(t^2 + t^{-2}) - (1 + m)(t^{n-1} + t^{-(n-1)}) \\ & + (2 + 3m)(t^n + t^{-n}) - (1 + 3m)(t^{n+1} + t^{-(n+1)}) + m(t^{n+2} + t^{-(n+2)}). \end{aligned}$$

The proof of Lemma 3.8 is achieved by a direct calculation of the Alexander polynomial by using a Seifert matrix. We omit the proof of Lemma 3.8.

Lemma 3.9. *Let K be a slice knot. Then the constant term of $\Delta_K(t)$ is positive.*

Proof. Since K is slice, there exists a polynomial $F(t) = \sum_{i \geq 0} b_i t^i$ such that $\Delta_K(t) = F(t)F(t^{-1})$.

This fact was proved by Fox and Milnor [8], and independently by Terasaka [25]. Then we see that the constant term of $\Delta_K(t)$ is equal to $\sum_{i \geq 0} b_i^2$. \square

Recall that a knot $K \subset S^3$ is said to be *ribbon* if K is the boundary of a smoothly immersed disk $D^2 \looparrowright S^3$ with only ribbon singularities. Clearly a ribbon knot is slice. Now we prove Theorem 3.6.

Proof of Theorem 3.6. First, we determine the n -shake genus $g_s^n(K_{n,m})$. Let $R(m)$ be the knot depicted in the right side of Figure 14. Then we have the following.

Claim 3.10. $X_{K_{n,m}}(n) \approx X_{R(m)}(n)$. In particular, $g_s^n(K_{n,m}) = 0$.

Proof. We see that $X_{K_{n,m}}(n) \approx X_{R(m)}(n)$ by Kirby calculus as shown in Figures 16 and 17. Thus we have $g_s^n(X_{K_{n,m}}(n)) = g_s^n(X_{R(m)}(n))$. Since $R(m)$ is ribbon, $g_s^n(R(m)) = g_*(R(m)) = 0$. Therefore $g_s^n(X_{K_{n,m}}(n)) = 0$. \square

Next we determine the 4-ball genus $g_*(K_{n,m})$ for $n \neq 0$ and $m \geq 0$.

Claim 3.11. *For integers $n \neq 0$ and $m \geq 0$, $g_*(K_{0,m}) = 0$ and $g_*(K_{n,m}) = 1$.*

Proof. We see that $K_{0,m}$ is ribbon. Therefore $g_*(K_{0,m}) = 0$. Since $\Delta_{K_{n,m}}(0) < 0$ by Lemma 3.8, we see that $g_*(K_{n,m}) \geq 1$ by Lemma 3.9. Since $K_{n,m}$ can be transformed into the unknot by two band surgeries, we see that $g_*(K_{n,m}) \leq 1$. Thus we have $g_*(K_{n,m}) = 1$ for $n \neq 0$ and $m \geq 0$. \square

Now we have completed the proof of Theorem 3.6. \square

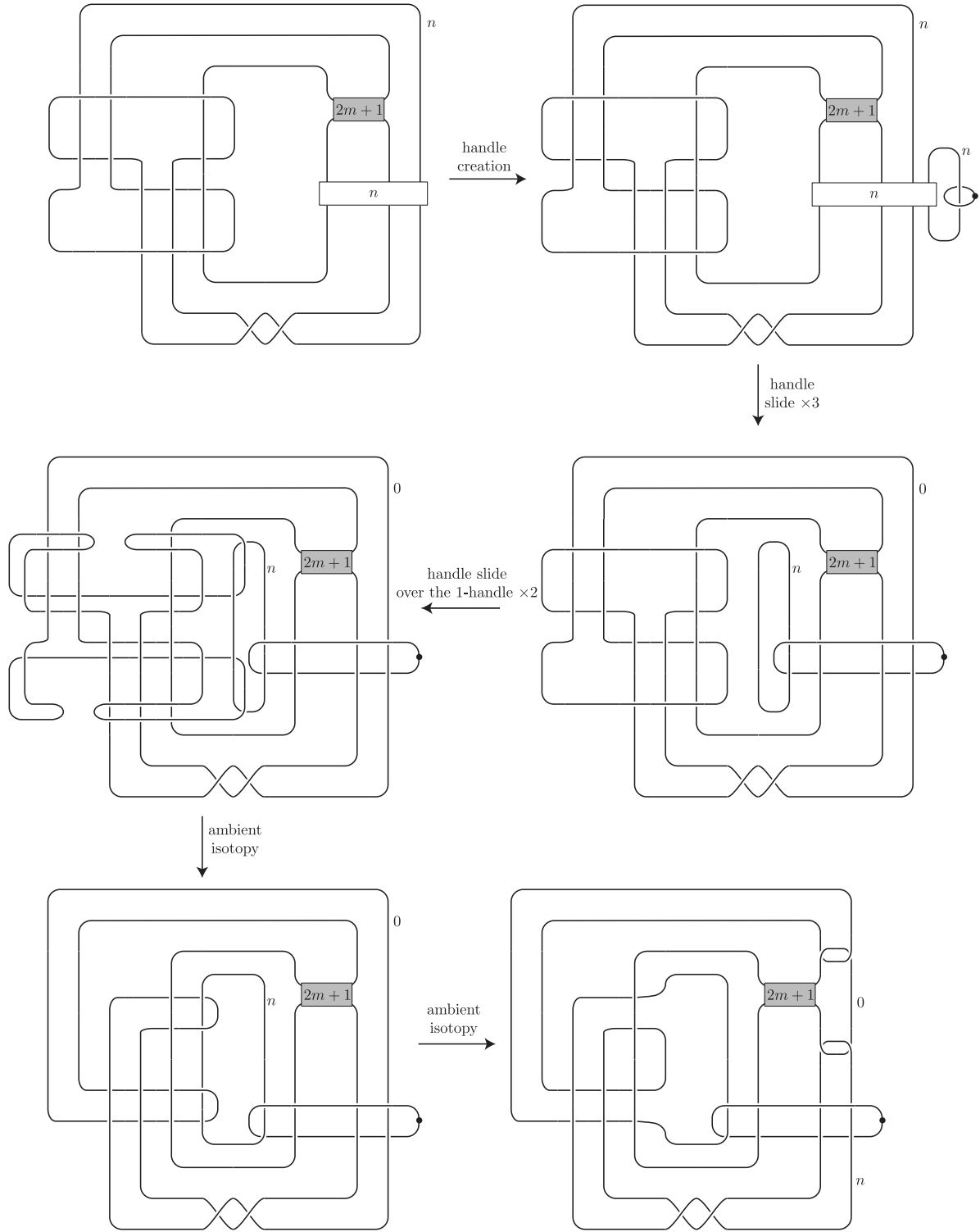

FIGURE 16. $X_{K_{n,m}}(n) \approx X_{R(m)}(n)$.

Remark 3.12. We can check that $\Delta_{R(m)}(t) = 3 - (t^2 + t^{-2})$. Let ω be n -th root of the unity. Then $\Delta_{K_{n,m}}(\omega) = \Delta_{R(m)}(\omega) = 3 - (\omega^2 + \omega^{-2})$. In fact, let K_1 and K_2 be knots such that

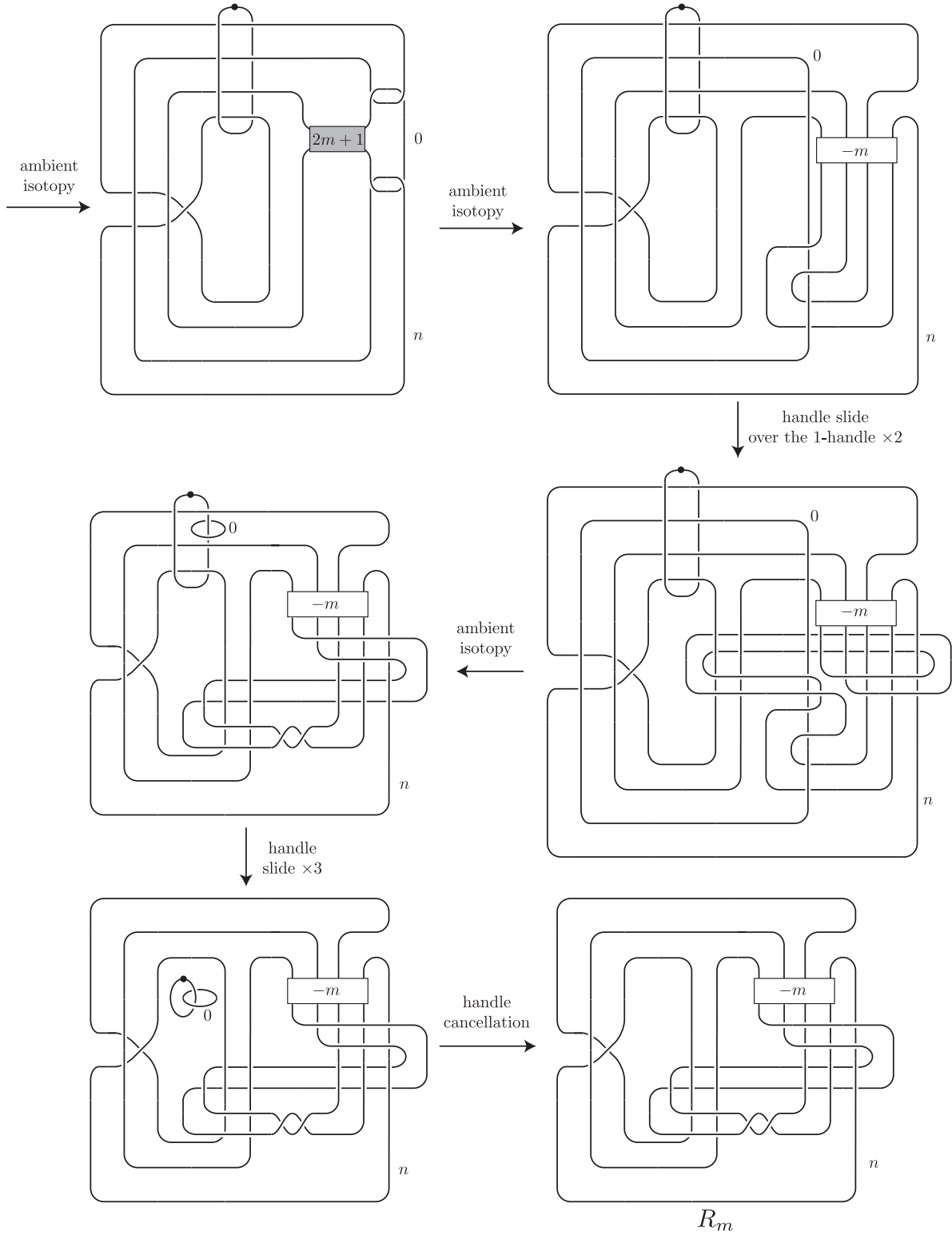

FIGURE 17. $X_{K_{n,m}}(n) \approx X_{R(m)}(n)$. (continued)

$\partial X_{K_1}(n) \approx \partial X_{K_2}(n)$. Then $H_1(\Sigma_n(K)) \cong H_1(\Sigma_n(K'))$, where $\Sigma_n(K)$ denotes the n -fold cyclic branched covering space of S^3 branched along K . In particular, $\Delta_K(\omega) = \Delta_{K'}(\omega)$.

REFERENCES

- [1] T. Abe, R. Hanaki and R. Higa. The unknotting number and band-unknotting number of a knot, *Osaka J. Math* **49** (2012), no. 2, 523–550.
- [2] T. Abe and T. Kanenobu. Unoriented band-surgery on knots and links, *preprint*.
- [3] S. Akbulut. Knots and exotic smooth structures on 4-manifolds, *J. Knot Theory Ramifications* **2** (1993), no. 1, 1–10.
- [4] S. Akbulut. On 2-dimensional homology classes of 4-manifolds, *Math. Proc. Cambridge Philos. Soc.* **82** (1977), no. 1, 99–106.
- [5] S. Akbulut. *4-manifolds*, draft of a book (2012), available at <http://www.math.msu.edu/~akbulut/papers/akbulut.1ec.pdf>
- [6] R. Brakes. Manifolds with multiple knot-surgery descriptions, *Math. Proc. Cambridge Philos. Soc.* **87** (1980), no. 3, 443–448.
- [7] J. Cerf. Sur les difféomorphismes de la sphere de dimension trois ($\Gamma_4 = 0$), *Lecture Notes in Mathematics*, No. 53, Springer-Verlag, Berlin-New York (1968) xii+133 pp.
- [8] R. H. Fox and J. W. Milnor. Singularities of 2-spheres in 4-space and cobordism of knots, *Osaka J. Math.* **3** (1996), 257–267.
- [9] D. Gabai. Foliations and the topology of 3-manifolds. III, *J. Differential Geom.* **26** (1987), no. 3, 479–536.
- [10] R. Gompf and K. Miyazaki. Some well-disguised ribbon knots, *Topology Appl.* **64** (1995), no. 2, 117–131.
- [11] R. Gompf and A. Stipsicz. *4-manifolds and Kirby calculus*, Graduate Studies in Mathematics, **20**. American Mathematical Society, Providence, RI, 1999. xvi+558.
- [12] A. Kawauchi. Mutative hyperbolic homology 3-spheres with the same Floer homology, *Geom. Dedicata* **61** (1996), no. 2, 205–217.
- [13] R. Kirby. *Problems in Low-Dimensional Topology*, AMS/IP Stud. Adv. Math., **2**(2), Geometric topology (Athens, GA, 1993), 35–473, Amer. Math. Soc., Providence, RI, 1997.
- [14] R. Kouno. 3-manifold with infinitely many knot surgery descriptions, (in Japanese) master thesis of Nihon University (2002).
- [15] W. Neumann and D. Zagier. Volumes of hyperbolic three-manifolds, *Topology* **24** (1985), no. 3, 307–332.
- [16] W. B. R. Lickorish. Shake-slice knots, *Lecture Notes in Math.*, **722** (1979), 67–70.
- [17] W. B. R. Lickorish. Surgery on knots, *Proc. Amer. Math. Soc.* **60** (1976), 296–298.
- [18] C. Livingston. More 3-manifolds with multiple knot-surgery and branched-cover descriptions, *Math. Proc. Cambridge Philos. Soc.* **91** (1982), no. 3, 473–475.
- [19] Y. Omae. 4-manifolds constructed from a knot and the shake genus, (in Japanese) master thesis of Osaka University (2011).
- [20] J. Osoinach. Manifolds obtained by surgery on an infinite number of knots in S^3 , *Topology* **45** (2006), no. 4, 725–733.
- [21] T. Saito and M. Teragaito. Knots yielding diffeomorphic lens spaces by Dehn surgery, *Pacific J. Math.* **244** (2010), no. 1, 169–192.
- [22] M. Takeuchi. Infinitely many distinct framed knots which represent a diffeomorphic 4-manifold, (in Japanese) master thesis of Osaka University (2009).
- [23] M. Teragaito. A Seifert fibered manifold with infinitely many knot-surgery descriptions, *Int. Math. Res. Not. IMRN* 2007, no. 9, Art. ID rnm 028, 16 pp.
- [24] M. Teragaito. Homology handles with multiple knot-surgery descriptions, *Topology Appl.* **56** (1994), no. 3, 249–257.
- [25] H. Terasaka. On null-equivalent knots, *Osaka Math. J.* **11** (1959), 95–113.
- [26] B. Winter. On Codimension Two Ribbon Embeddings, *arXiv:0904.0684* (2009).

RESEARCH INSTITUTE FOR MATHEMATICAL SCIENCES, KYOTO UNIVERSITY, KYOTO 606-8502, JAPAN
E-mail address: `tetsuya@kurims.kyoto-u.ac.jp`

FACULTY OF LIBERAL ARTS AND SCIENCES, OSAKA PREFECTURE UNIVERSITY, 1-1 GAKUEN-CHO,
NAKAKU, SAKAI, OSAKA 599-8531, JAPAN
E-mail address: `jong@las.osakafu-u.ac.jp`

OSAKA PREFECTURAL KITANO HIGH SCHOOL, OSAKA 532-0025, JAPAN
E-mail address: `T-OmaeYu@medu.pref.osaka.jp`

DEPARTMENT OF MATHEMATICS, GRADUATE SCHOOL OF SCIENCE, OSAKA UNIVERSITY, TOYONAKA,
OSAKA 560-0043, JAPAN