

A Study of Beam Position Diagnostics with Beam-excited Dipole Higher Order Modes using a Downconverter Test Electronics in Third Harmonic 3.9 GHz Superconducting Accelerating Cavities at FLASH

P. Zhang^{†‡*}, N. Baboi[‡], N. Eddy[#], B. Fellenz[#], R.M. Jones^{†*},
B. Lorbeer[‡], T. Wamsat[‡], M. Wendt[#]

[†]The University of Manchester, Manchester, U.K.

[‡]DESY, Hamburg, Germany

^{*}The Cockcroft Institute, Daresbury, U.K.

[#]Fermilab, Batavia, Illinois 60510, U.S.A.

October 15, 2021

Abstract

Beam-excited higher order modes (HOM) in accelerating cavities contain transverse beam position information. Previous studies have narrowed down three modal options for beam position diagnostics in the third harmonic 3.9 GHz cavities at FLASH. Localized modes in the beam pipes at approximately 4.1 GHz and in the fifth cavity dipole band at approximately 9 GHz were found, that can provide a local measurement of the beam position. In contrast, propagating modes in the first and second dipole bands between 4.2 and 5.5 GHz can reach a better resolution. All the options were assessed with a specially designed test electronics built by Fermilab. The aim is to define a mode or spectral region suitable for the HOM electronics. Two data analysis techniques are used and compared in extracting beam position information from the dipole HOMs: direct linear regression and singular value decomposition. Current experiments suggest a resolution of $50 \mu m$ accuracy in predicting local beam position using modes in the fifth dipole band, and a global resolution of $20 \mu m$ over the complete module. Based on these results we decided to build a HOM electronics for the second dipole band and the fifth dipole band, so that we will have both high resolution measurements for the whole module, and localized measurements for individual cavity. The prototype electronics is being built by Fermilab and planned to be tested in FLASH by the end of 2012.

Contents

1	Introduction	2
1.1	FLASH and the third harmonic cavities	2
2	HOM Measurements with the Test Electronics	4
2.1	The Principle of the Test Electronics	4
2.2	Downconverted HOM Signals	5
2.3	Measurement Scheme	8
3	Analysis Methods for Beam Position Diagnostics	11
3.1	Data Samples	11
3.2	Direct Linear Regression	13
3.3	Singular Value Decomposition	16
3.4	Comparison of DLR and SVD	19
4	Position Resolutions	21
4.1	The Localized Beam-pipe Dipole Modes	21
4.2	Coupled Cavity Modes - The First Dipole Band	25
4.3	Coupled Cavity Modes - The Second Dipole Band	28
4.4	Trapped Cavity Modes - The Fifth Dipole Band	33
4.5	Estimation of the Resolution	36
5	Summary	37
A	The Analog Box Circuit	3
B	Settings in the Analog Box	5
C	Tables: Position Resolutions	6
C.1	The Localized Beam-pipe modes	6
C.2	Coupled Cavity Modes - The First Dipole Band	7
C.3	Coupled Cavity Modes - The Second Dipole Band	8
C.4	Trapped Cavity Modes - The Fifth Dipole Band	11
D	Tables: Number of SVD Modes	12
D.1	The Localized Beam-pipe modes	12
D.2	Coupled Cavity Modes - The First Dipole Band	12
D.3	Coupled Cavity Modes - The Second Dipole Band	15
D.4	Trapped Cavity Modes - The Fifth Dipole Band	17

Chapter 1

Introduction

1.1 FLASH and the third harmonic cavities

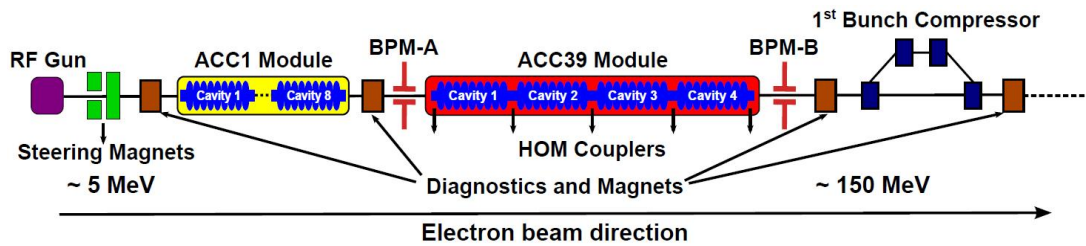
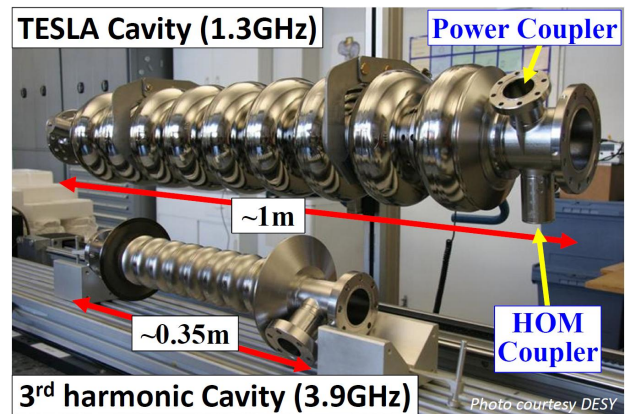

Figure 1.1: Schematic of injector section of the FLASH facility (not to scale, cavities in ACC1 are approximately three times larger than those in ACC39).

FLASH [1] is a free-electron laser (FEL) user facility at DESY in Hamburg providing ultrashort radiation pulses with an unprecedented brilliance. A schematic of the injector section of FLASH is shown in Fig. 1.1. A laser-driven RF gun generates a high quality electron beam. Seven superconducting 1.3 GHz TESLA type [2] modules accelerate the electron beam to a maximum energy of 1.2 GeV. Then the electron beam goes through an undulator section to produce laser like coherent FEL radiation.



(a) The ACC39 module



(b) Cavities

Figure 1.2: (a) The ACC39 module in FLASH beam line. The module in yellow, on the right, is ACC1. The direction of travel of the multi-bunch beam, is from right to left. (b) A TESLA style cavity operating at 1.3 GHz (top) and the corresponding third harmonic cavity (bottom).

A third harmonic module containing four 3.9 GHz superconducting cavities is installed in FLASH (Fig. 1.2(a)) in order to linearize the longitudinal phase space of the electron bunch [3]. Due to a special design [4], most higher order modes (HOMs) are above the cutoff frequency of the connecting beam

pipes, therefore are able to propagate among cavities. This leads to a significantly complex HOM spectrum of the 3.9 GHz cavity. Moreover, wakefields are much stronger in the 3.9 GHz cavities than those in the TESLA 1.3 GHz cavities. This is due to the smaller iris of the 3.9 GHz cavity which consequently scales up the wakefield with the second power for the longitudinal components and the third power for the transverse components [5]. Fig. 1.2(b) shows a comparison of the 1.3 GHz TESLA cavity and the 3.9 GHz cavity. If left unchecked, these HOMs will add adverse effects on the beam resulting a dilution of the beam quality. On the other hand, dipole higher order modes have linear dependence on the transverse beam position [5], and this enables the beam position to be determined remotely by monitoring these modes [6, 7, 8].

Higher order mode beam position monitors (HOMBPM) have the capability of measuring the beam position inside the accelerating cavity without additional vacuum components, while the traditional beam position monitors (BPMs) fall short of providing this information directly. However, a careful study on the cavity spectrum is required in order to secure an appropriate dipole mode. Since the cavity is not designed to be used as a diagnostics tool, the position resolution might be limited by the characterizations of the cavities.

Prior to designing any electronics for HOM-based beam diagnostics, extensive studies on the third harmonic cavities have been conducted. Concerning simulations, at first, eigenmode simulations have been performed on an ideal third harmonic cavity without couplers using three different simulation codes: MAFIA®[9, 10], HFSS®[11, 12] and CST Microwave Studio®[13, 14]. Then the entire third harmonic module consisting of four 3.9 GHz cavities have been simulated with three different schemes: Generalized Scattering Matrix (GSM) [15, 16], Coupled S-Parameter Calculation (CSC) [15, 17] and direct calculation using the ACE3P code suite [18, 19]. Regarding the measurement, a series of transmission measurements without beam excitations were conducted [15, 20], then beam-excited HOM spectra were measured [21, 20] and the dipole dependence on the beam offset were studied [20, 22, 23, 24]. Three modal options are therefore narrowed down [25] and the test electronics are subsequently designed and built by FNAL in order to study these modal options using both amplitude and phase of each mode for beam position diagnostics. Then a dedicated study has been conducted with the test electronics and the results are presented in this report.

In this report, the principle of the test electronics is introduced in Chapter 2 along with example output signals and various modal options tested in this study. In Chapter 3, two analysis methods used to extract beam position information from the HOM signals are explained and compared: direct linear regression (DLR) and singular value decomposition (SVD). Then the position resolution using one 20 MHz band of signals from each modal option is described in Chapter 4. Both time-domain and frequency-domain signals are studied and compared. Extensive tables of position resolutions for all modal options studied are listed in Appendix C, while the number of SVD modes used to achieve these resolutions is listed in Appendix D.

Chapter 2

HOM Measurements with the Test Electronics

Previous studies suggest three promising modal options for beam position diagnostics [25]. These are dipole beam-pipe modes at approximately 4 GHz, the first two dipole cavity bands at 4–5.5 GHz and the fifth dipole cavity band at approximately 9 GHz. A test electronics has been built to study these options in FLASH as explained in this chapter.

2.1 The Principle of the Test Electronics

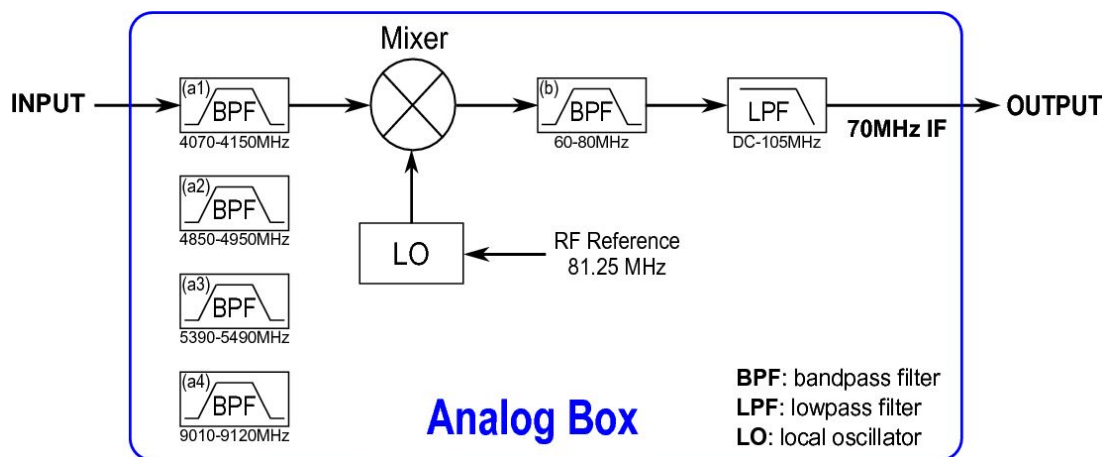

Figure 2.1: Schematics of the analog box. Only one of the four BPFs (a1-a4) is connected in the chain during each measurement.

The analog electronics was designed to have the flexibility to study various modal options of interest as well as accommodate the large mode bandwidths (BW) of these options. Its simplified block diagram is shown in Fig. 2.1. One of four different analog bandpass filters (BPF) can be connected into the chain to study the localized dipole beam-pipe modes at ~ 4.1 GHz, strong multi-cavity modes in the first dipole band at ~ 4.9 GHz and in the second dipole band at ~ 5.4 GHz, and the trapped cavity modes in the fifth dipole band at ~ 9 GHz. After filtering, the signal is mixed with a selectable local oscillator (LO) to an intermediate frequency (IF) of approximately 70 MHz. Then the 70 MHz IF signal is further filtered with a 20 MHz analog BPF to select the specific band of modes. In order to ensure that the possible remaining high frequency components of the IF signal generated during the mixing step are well suppressed, a lowpass filter (LPF) is applied to preserve only the frequency below 105 MHz with a dominant component from 60 MHz to 80 MHz. In Fig. 2.1, the “INPUT” is connected to a RF multiplexer to allow for a fast switching among HOM couplers as shown in Fig. 2.2. The 70 MHz IF out of the analog box is further split into two signals. One is digitized by a VME digitizer operating at 216 MS/s with 14 bit resolution¹ and 2 Volt peak to peak

¹The output value from the VME digitizer has 16 bit with the last two digits both set to 0. It was for easy data processing

signal range along with a programmable FPGA for signal processing. The digitizer is triggered by a 10 Hz beam trigger, which is the RF-pulse repetition rate of FLASH. Both the selectable LO and the digitizer clock of 216 MHz are locked to the FLASH accelerator by using RF signals delivered from the FLASH master oscillator as a reference. This locking allows correct phase information of the digitized signal. The other IF signal is processed by a μ TCA [26] digitizer with 16 bit resolution and 2 Volt peak to peak signal range operating at 108 MS/s. Since the IF is approximately 70 MHz, the μ TCA ADC is undersampled. Both the trigger and the clock of the μ TCA digitizer are directly delivered from the FLASH master oscillator, which is automatically locked to the FLASH accelerator. All the devices are set up in the FLASH injector barrack outside the accelerator tunnel. The detailed circuit drawing of the analog electronics is shown in Appendix A along with photos of the device setup, the analog box and the digitizers. Digitized data is collected from the VME digitizer with an EPICS [27] software tool, while FLASH control system DOOCS [28] takes care of the data collection for the μ TCA digitizer. The beam charge, steerer current and BPM readouts are recorded synchronously from DOOCS. The data processing for position diagnostics is conducted offline using MATLAB [29].

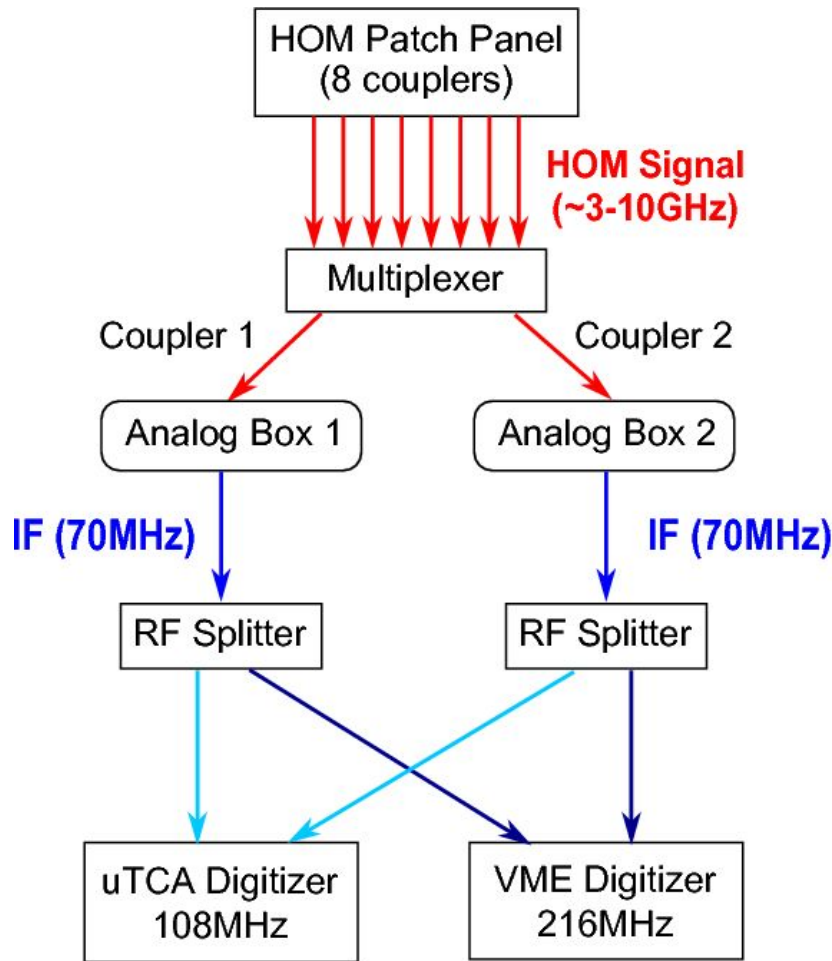

Figure 2.2: Schematic device setup in the injector barrack outside the FLASH tunnel.

Inside the analog box, individual attenuation and amplification was used for different frequency band. This is for the optimization of the signal level while accommodating the variation of HOM power amongst couplers. These are shown in Appendix B.

2.2 Downconverted HOM Signals

The downconverted HOM signals after splitting are processed by both the VME and μ TCA digitizer. Fig. 2.3 shows the raw waveform of each HOM coupler for the 9066 MHz (BW: 20 MHz) digitized by VME. This with the FPGA. The real resolution is still 14 bit.

frequency range is within the fifth dipole band. The strength of the signal varies dramatically among couplers. This might be due to the different coupling of the HOM couplers, which can also be contributed by the fact that modes within the 20 MHz band are trapped inside each cavity. Therefore dissimilar cavities attributed to fabrication tolerances give rise to the differences presented in the waveforms. Applying a fast Fourier transform (fft) on the waveforms in Fig. 2.3, the amplitude of each fft output is shown in Fig. 2.4. The spectra differ among cavities and HOM couplers.

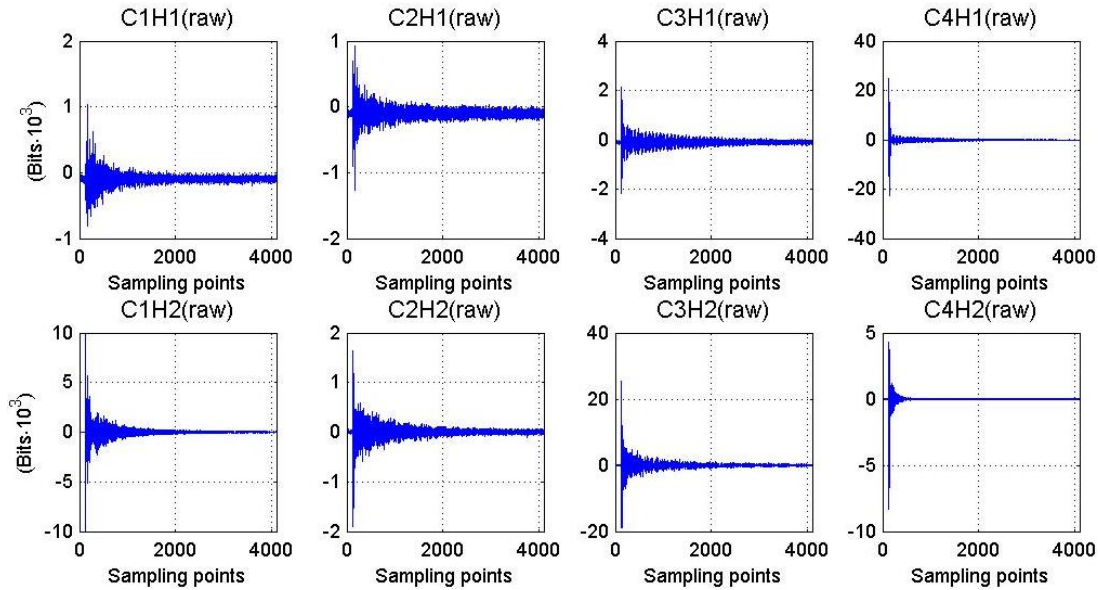

Figure 2.3: Raw waveforms measured by the VME digitizer for each HOM coupler. The center frequency is 9066 MHz with a 20 MHz BPF. Different vertical scale is used for each waveform.

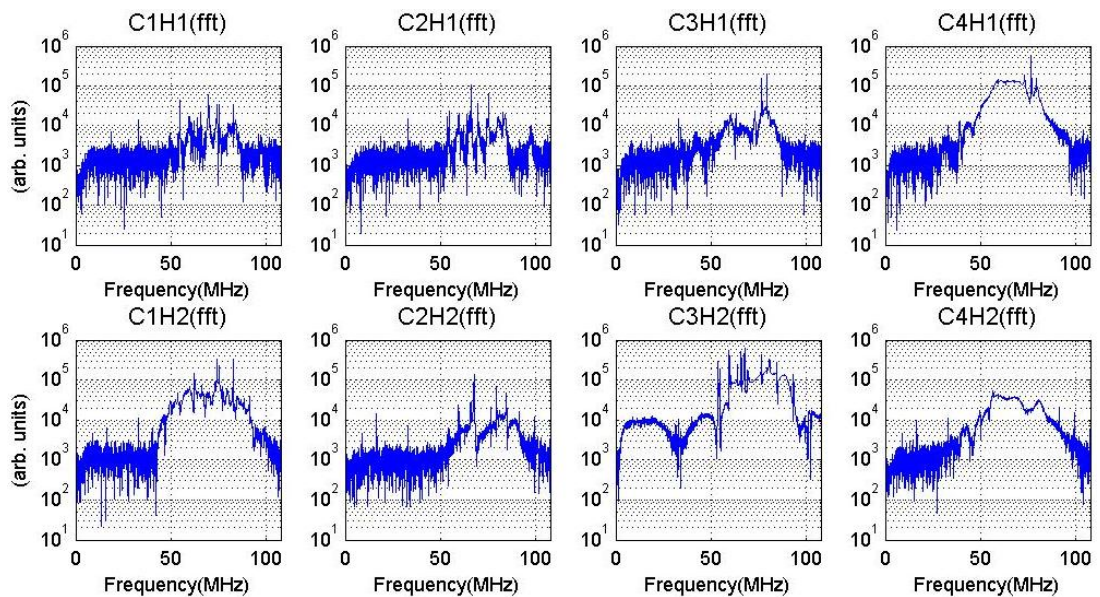

Figure 2.4: FFT amplitude of the raw waveform measured by the VME digitizer for each HOM coupler. The center frequency is 9066 MHz with a 20 MHz BPF.

Fig. 2.5 shows the waveforms for the 5437 MHz (BW: 20 MHz) digitized by VME. This frequency range is within the second dipole band. The signal strength is similar for each coupler. Since modes in this band propagate through the module, couplers pick up similar signals. The differences come from the couplers' dissimilar coupling and their locations. Fig. 2.6 shows the fft amplitudes of the waveforms.

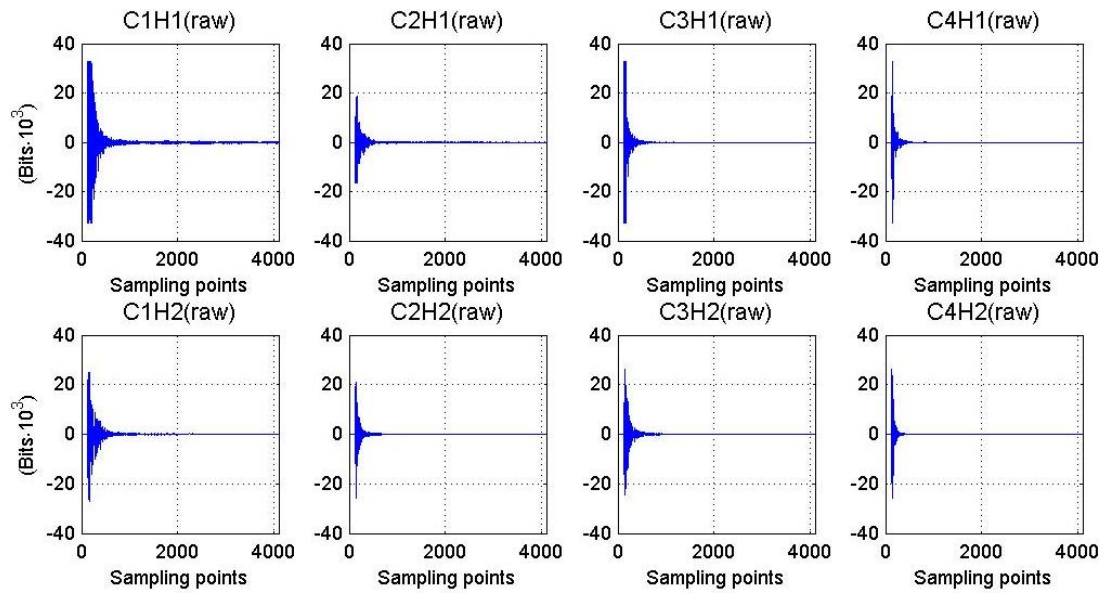

Figure 2.5: Raw waveforms measured by the VME digitizer for each HOM coupler. The center frequency is 5437 MHz with a 20 MHz BPF.

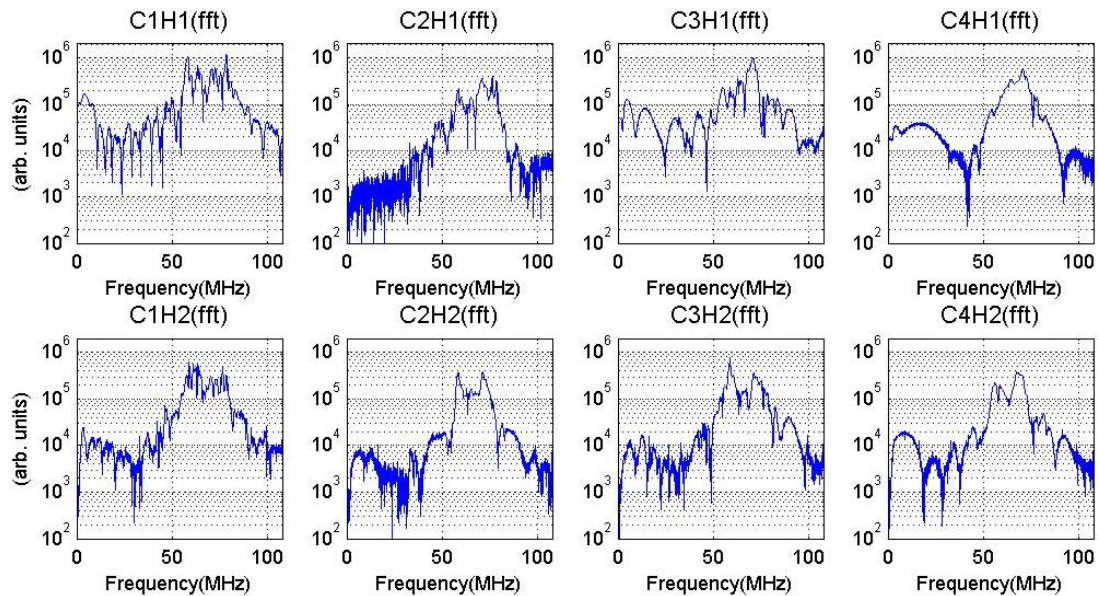

Figure 2.6: FFT amplitude of the raw waveform measured by the VME digitizer for each HOM coupler. The center frequency is 5437 MHz with a 20 MHz BPF.

2.3 Measurement Scheme

The schematics of the measurement setup is shown in Fig. 2.7. An electron bunch of approximately 0.5 nC is accelerated on-crest through ACC1 before entering the ACC39 module. Two steering magnets located upstream of ACC1 are used to produce horizontal and vertical offsets of the electron bunch in ACC39. Two beam position monitors (BPM-A and BPM-B) are used to record transverse beam positions before and after ACC39. Switching off the accelerating field in ACC39 and all quadrupoles close to ACC39, a straight line trajectory of the electron bunch is produced between those two BPMs. Therefore, the transverse offset of the electron bunch in the module can be determined by interpolating the readouts of the two BPMs.

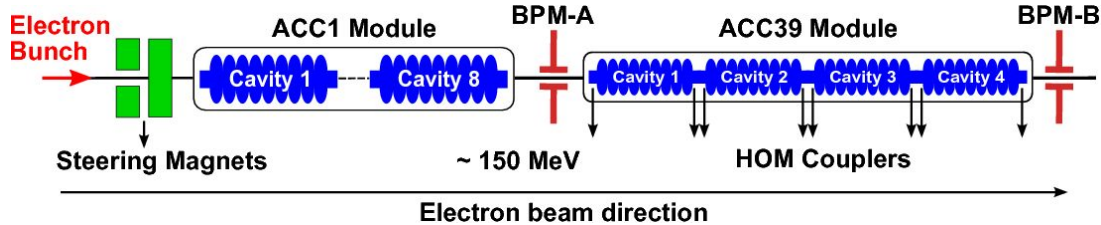

Figure 2.7: Schematic of measurement setup for HOM study (not to scale, cavities in ACC1 are approximately three times larger than those in ACC39).

To study the position dependencies of HOMs, we moved the beam in a 2D grid manner. Fig. 2.8(a) shows the steerer current during the movement. The samples in blue are used for calibration, and then validation² samples were taken as shown in red. The usage of the samples are explained in Chapter 3. Fig. 2.8(b) and Fig. 2.8(c) show the relations of the steerer current to the readings of BPM-A (dots) and BPM-B (asterisks). Fig. 2.8(d) and Fig. 2.8(g) show the readings of BPM-A and BPM-B during the beam movement. The angle of the beam trajectory is represented by x' and y' , and its relations to the bpm readings are shown in Fig. 2.8(e)(f)(h)(i). When the readings of BPM-A were close to zero for both x and y plane, the readouts jumped between positive and negative unpredictably. In order to cure this, we use the currents of steering magnets to correct the problematic BPM readings. From the measurement results, the jumping in x plane is not severe, therefore only the readings of y have been corrected for all measurements shown in this report.

²A set of coefficients is first generated during calibration. Then the newly measured HOM signals are applied with these coefficients to make predictions of beam positions. This is called validation.

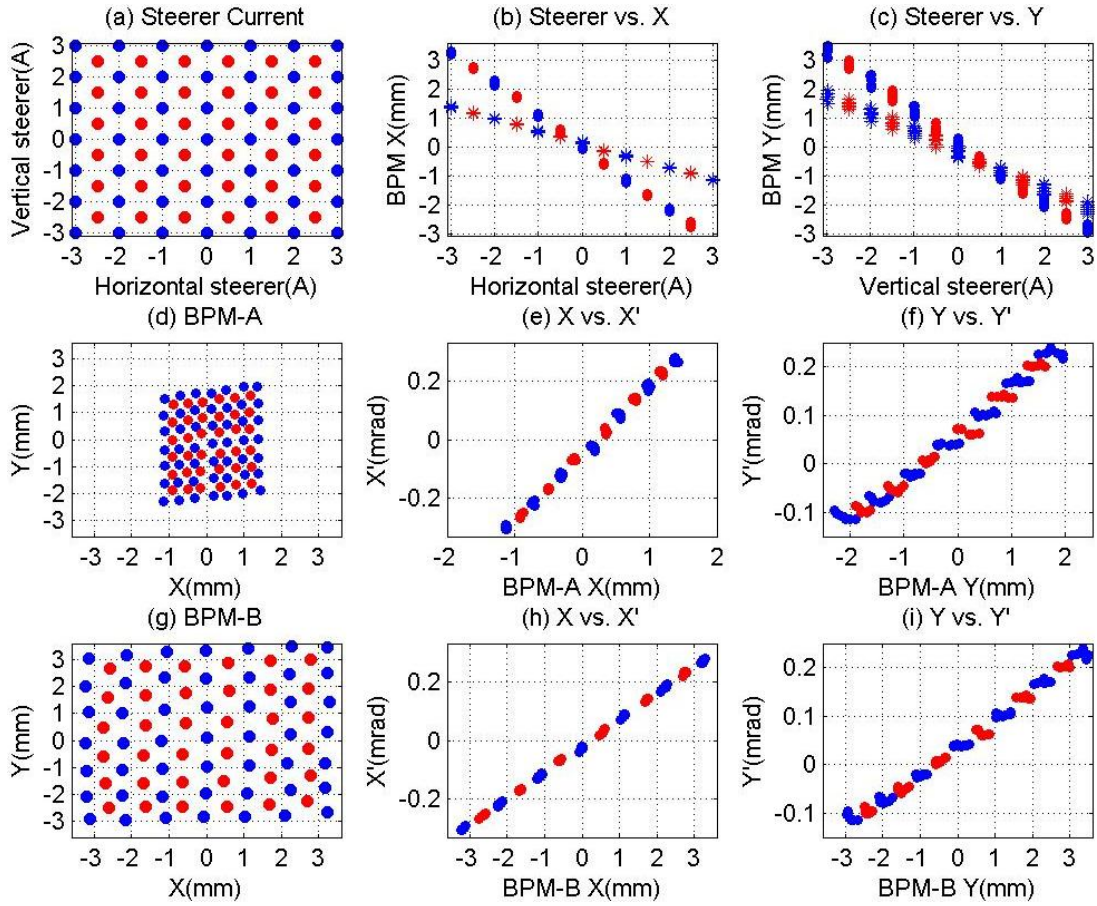

Figure 2.8: 2D grid-like beam movement. The calibration samples are in blue while the validation samples are in red. In (b) and (c), dots represent the readings from BPM-A while asterisks for BPM-B.

As we are dealing with trapped and coupled modes, two schemes of position interpolations are used. The transverse beam position is interpolated into each cavity center for trapped modes as shown in Fig. 2.9. Fig. 2.10(a) shows the interpolated position of each cavity center. This enables the local positions in each cavity to be determined by the non-propagating modes extracted from each cavity. Since the coupled modes are propagating through the four-cavity module, we decide to interpolate the beam position into the center of the whole module considering the four cavities in its entirety. The interpolation is shown in Fig. 2.11 and the interpolated position of the module center is shown in Fig. 2.10(b). One notices some non-straight lines in Fig. 2.10(a) on the bottom right, and it might be due to the beam jitter as only one cavity was measured at each time.

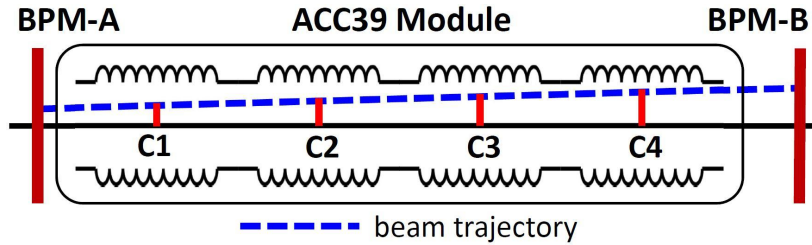

Figure 2.9: Position interpolation into the center of each cavity for localized modes.

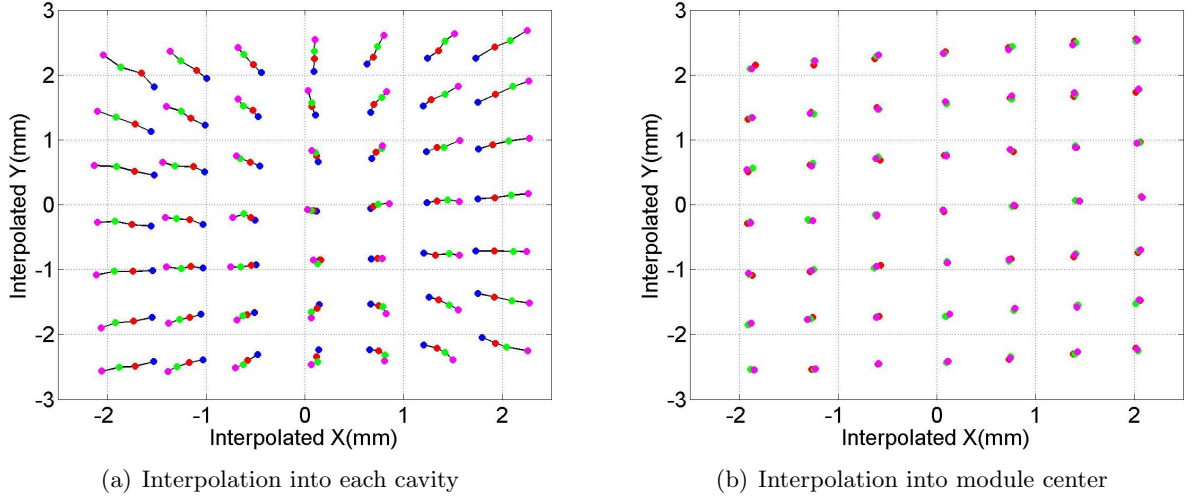

Figure 2.10: (a) Interpolated position at each cavity center colored as C1 (blue), C2 (red), C3 (green) and C4 (magenta). Points connected with black lines belong to the same beam position. (b) Interpolated position at the module center when measuring C1 (blue), C2 (red), C3 (green) and C4 (magenta). Only the calibration samples are shown.

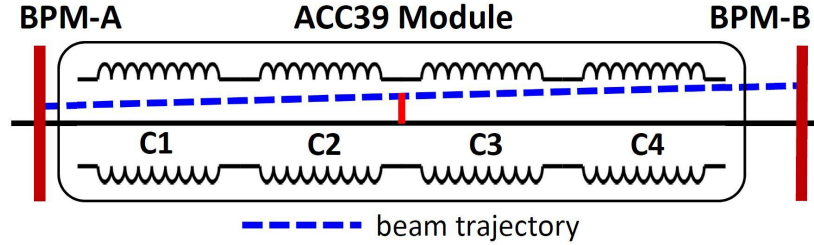

Figure 2.11: Position interpolation into the center of the whole module for coupled modes.

In this report, three modal options have been studied. The center frequencies and the BWs for these options that we have set on the test electronics during the measurement are listed in Table 2.1. For the first and second dipole band, we also studied the diagnostics with a broadband signal by removing the 20 MHz BPF after the mixer. In this case, the BW of the IF signal was 100 MHz determined by the BPF in front of the mixer and the LPF.

Table 2.1: Modal options studied with the test electronics.

Beam-pipe modes		1 st dipole band		2 nd dipole band		5 th dipole band	
Center	BW	Center	BW	Center	BW	Center	BW
4082 MHz	20 MHz	4859 MHz	20 MHz	5437 MHz	20 MHz	9048 MHz	20 MHz
4118 MHz	20 MHz	4904 MHz	20 MHz	5464 MHz	20 MHz	9066 MHz	20 MHz
		4940 MHz	20 MHz	5482 MHz	20 MHz		
		4900 MHz	100 MHz	5450 MHz	100 MHz		

Chapter 3

Analysis Methods for Beam Position Diagnostics

Two different analysis methods are used to extract beam position information from the HOM signals: direct linear regression and singular value decomposition. These are explained and compared in this chapter.

3.1 Data Samples

In this chapter, waveforms measured from HOM coupler C3H2 with the VME digitizer are used to describe two data analysis techniques. The center frequency has been set to 9066 MHz with a 20 MHz BW. One example of the downconverted waveforms is shown in Fig. 3.1(a). The downconverted waveforms are applied with a mathematical ideal filter to keep the range from 56 MHz to 101 MHz in order to cut away the coupling modes at approximately 55 MHz. Fig. 3.1(b) shows one example of the spectrum after a fft was applied on the waveform shown in Fig. 3.1(a). The filtered waveform is shown in Fig. 3.1(c) in blue as one example. Since the signal decays fast, a time window is further applied on the filtered signal which is shown as the red waveform in Fig. 3.1(c). All waveforms have been normalized to 1 nC bunch charge, and one of the them is shown in Fig. 3.2(a). The beam has been moved in a grid manner. As shown in Fig. 3.2(b), a 7×7 grid is used for calibration (49 samples, blue dots) and a 6×6 grid is used as validation samples (36 samples, red dots) in order to obtain full coverage in 2D space for both samples within the linear range of BPM-B (-3 mm to +3 mm).

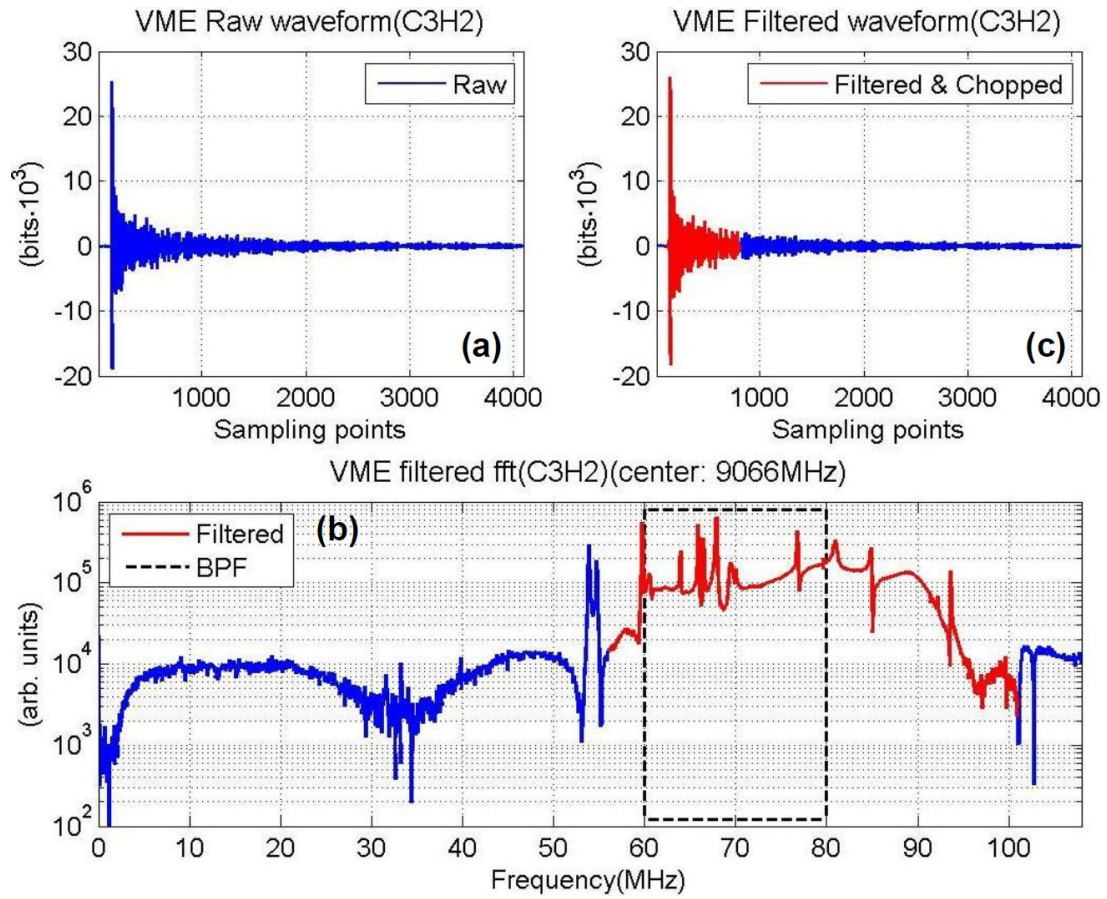

Figure 3.1: Waveform measured with VME-based digitizer (center frequency: 9066 MHz, BW: 20 MHz).

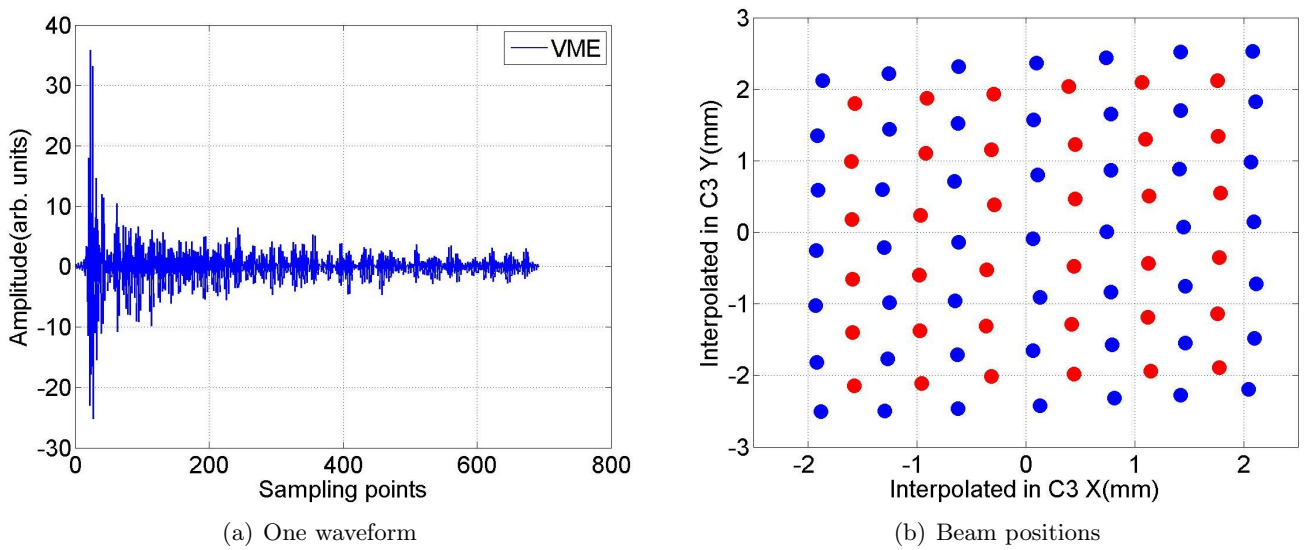

Figure 3.2: (a) One waveform measured from C3H2. (b) Grid-like beam movement (calibration samples are in blue and validation samples are in red). The positions are interpolated in C3.

3.2 Direct Linear Regression

To extract beam position information from the dipole modes, a straightforward method is direct linear regression (DLR),

$$A \cdot M = B. \quad (3.1)$$

In this equation, matrix A contains the waveforms, B is the matrix of transverse beam position x and y interpolated from the two BPM readouts. The angle of the beam trajectory x' and y' is not the subject of this study. M is the matrix of regression coefficients. The arrangement of matrix A and B are

$$A = \begin{pmatrix} waveform_1 \\ waveform_2 \\ \vdots \\ waveform_m \end{pmatrix} = \begin{pmatrix} a_{11} & a_{12} & \dots & a_{1n} \\ a_{21} & a_{22} & \dots & a_{2n} \\ \vdots & \vdots & \ddots & \vdots \\ a_{m1} & a_{m2} & \dots & a_{mn} \end{pmatrix} = \begin{pmatrix} r_1^T \\ r_2^T \\ \vdots \\ r_m^T \end{pmatrix} = \begin{pmatrix} c_1^T \\ c_2^T \\ \vdots \\ c_n^T \end{pmatrix}^T \in \mathbb{R}^{m \times n}, \quad (3.2)$$

$$B = \begin{pmatrix} B_1 \\ B_2 \\ \vdots \\ B_m \end{pmatrix} = \begin{pmatrix} x_1 & y_1 \\ x_2 & y_2 \\ \vdots & \vdots \\ x_m & y_m \end{pmatrix} \in \mathbb{R}^{m \times 2}. \quad (3.3)$$

A is a $m \times n$ matrix. a_{ij} represents the value of j^{th} sampling point in $waveform_i$. The superscript T denotes the vector or matrix transpose. $r_i^T \in \mathbb{R}^n$ is the i^{th} row of A , which is the $waveform_i$ for a particular beam position. $c_i \in \mathbb{R}^m$ is the i^{th} column of A , representing the i^{th} regressor or variable. $B_i \in \mathbb{R}^2$ is the i^{th} row of matrix $B \in \mathbb{R}^{m \times 2}$. It represents the interpolated horizontal coordinate x_i and vertical coordinate y_i of the i^{th} beam position corresponding to the measurement of $waveform_i$. In order to characterize the DC components in the waveforms, an intercept term is added into A and M by adding one column of 1 in A and one row of coefficients in M as

$$A^* = (I, A) \in \mathbb{R}^{m \times (n+1)}, \quad (3.4)$$

$$M^* = \begin{pmatrix} M_0 \\ M \end{pmatrix} \in \mathbb{R}^{(n+1) \times 2}, \quad (3.5)$$

where $I \in \mathbb{R}^{m \times 1}$ and $M_0 \in \mathbb{R}^{1 \times 2}$. Matrix M is obtained by solving linear system composed by A^* and B for calibration samples.

The predictions of B can be obtained by

$$B_{pre} = A^* \cdot M^* \quad (3.6)$$

for both calibration and validation samples. Applying DLR on the waveforms measured from HOM coupler C3H2 split as Fig. 3.2(b), we obtain the results for both samples. In Fig. 3.3(a), the prediction and the measurement almost overlap, which proves the linear dependence of the waveform on the transverse beam offset. Fig. 3.3(b) shows that the M obtained from calibration has good prediction power. To measure the consistency, the coefficient of determination r^2 is calculated ($r^2 = 1$, perfect fit; $r^2 = 0$, poor fit) [30]. The difference between the predicted position B_{pre} and the measured position B is defined as the *prediction error*,

$$prediction\ error = |B_{pre} - B|. \quad (3.7)$$

Fig. 3.4 shows the prediction error for calibration and validation samples by using DLR, together with the rms value of the prediction error, E_{RMS} . Then the position resolution is given by E_{RMS} of the validation samples. Therefore, the resolution achieved by DLR is $47 \mu m$ for x and $56 \mu m$ for y .

The algorithm used in solving the linear system (in the form of Eq. 3.1) is least squares, which is a standard method to solve linear regression problems. The method relies on minimizing the difference of prediction (B_{pre}) and measurement (B) whilst modifying the elements of the matrix M^* . In our case, the size of matrix M^* is related to the number of sampling points, therefore a considerable number of unknown variables (in this particular case, 701) needs to be determined. This is computationally expensive. As

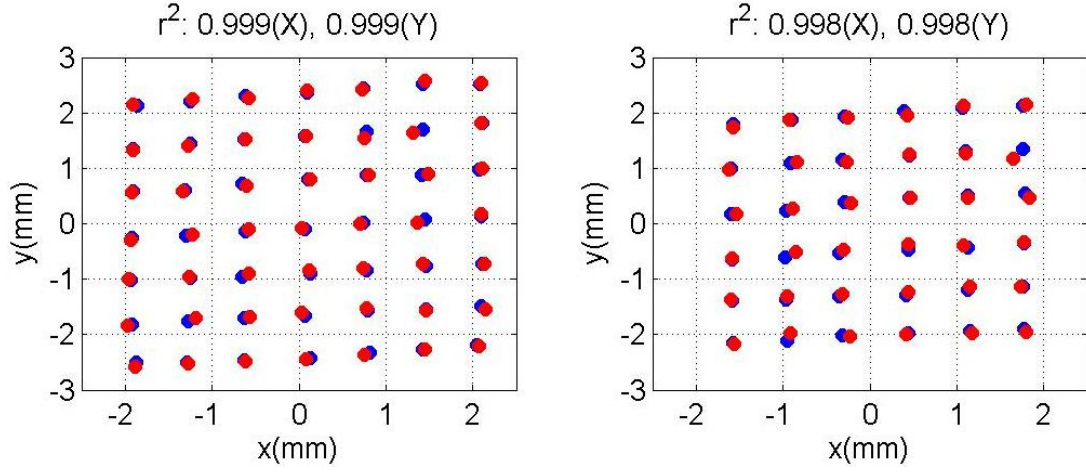

Figure 3.3: Measurement (blue) and prediction (red) of the transverse beam position from calibration (left) and validation (right) samples. The applied method is DLR.

all sampling points are used in the regression, each column of matrix A is a regressor. The correlation coefficients $R \in \mathbb{R}^{n \times n}$ of these regressors are calculated as

$$R(i, j) = \frac{\text{Cov}(c_i, c_j)}{\sqrt{\text{Cov}(c_i, c_i) \cdot \text{Cov}(c_j, c_j)}}, \quad (3.8)$$

where c_i and c_j are i^{th} and j^{th} column of matrix A respectively defined in Eq. 3.2, $\text{Cov}(c_i, c_j)$ is the covariance between two regressors c_i and c_j . In this definition, $R = \pm 1$ means strong correlation while $R=0$ means no correlation. Fig. 3.5 shows the correlation coefficients of the calibration samples. Most regressors are strongly correlated and this makes the linear system sensitive to the fluctuations of the calibration samples. In our case, the system is vulnerable to noise. Moreover, even though it is not the case here, overfitting is always a potential problem unless the calibration samples are fairly large. To avoid these risks, it is better to reduce the system size from multi-hundred to several tens, and then apply linear regression on the reduced system. The method we used for this purpose is described in the following section.

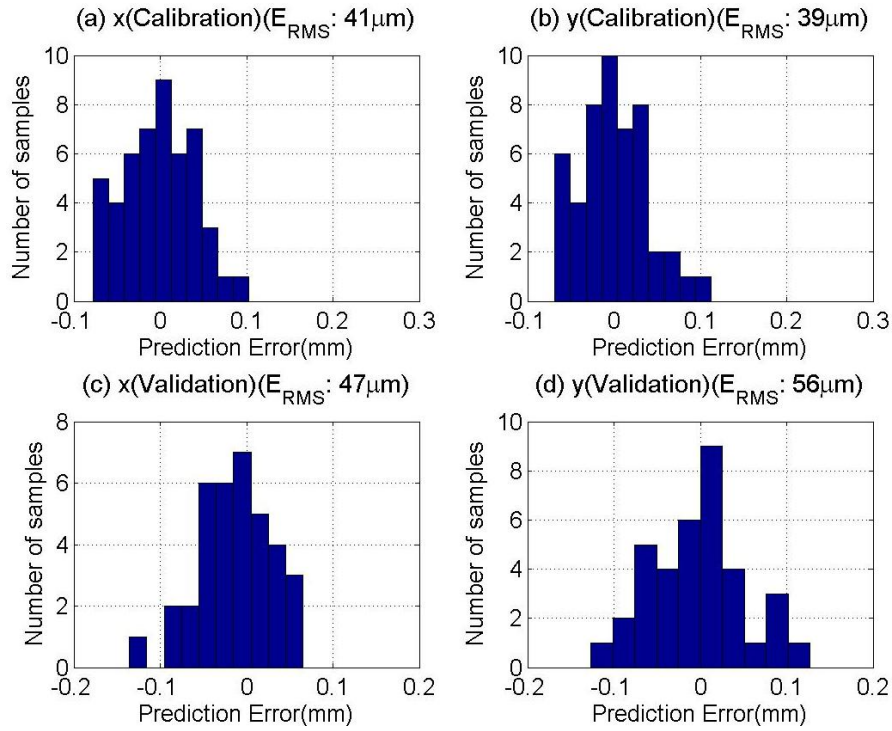

Figure 3.4: Difference of measured and predicted transverse beam position from calibration and validation samples. The applied method is DLR.

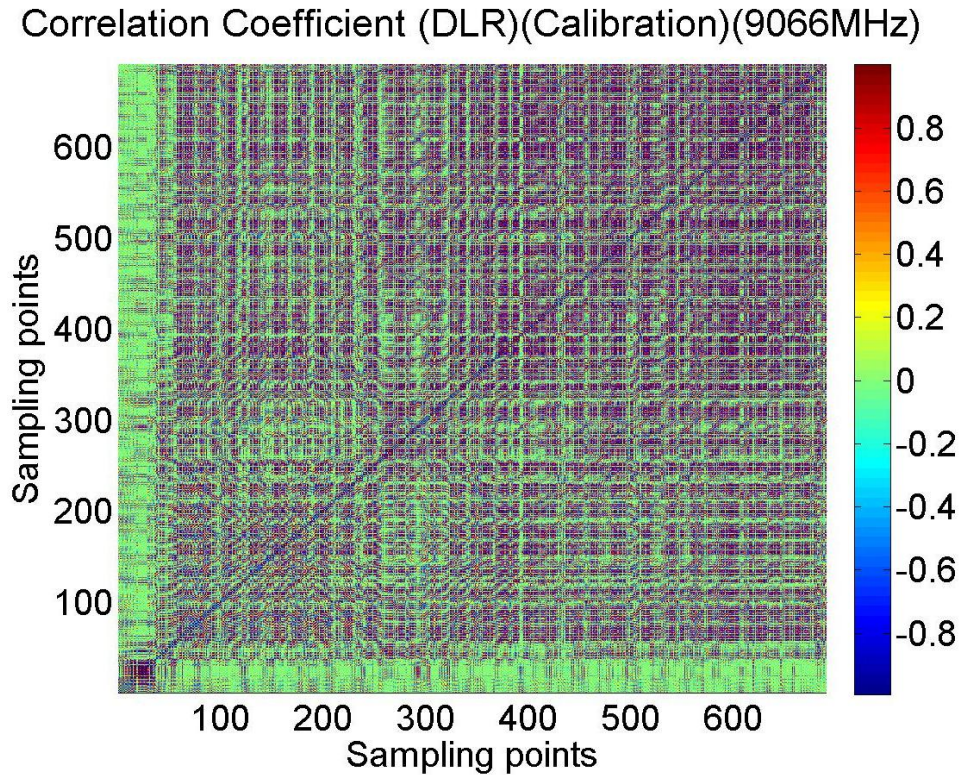

Figure 3.5: Correlation coefficients of the calibration samples.

3.3 Singular Value Decomposition

In order to find a small number of prominent components from the signal matrix A , a method known as *Singular Value Decomposition* (SVD) is used [31]. In general, SVD looks for patterns of a matrix in terms of SVD modes without relating them to any physical parameters (like dipole mode frequency, quality factor, beam position, etc.). Those SVD modes are natural groupings of the signal matrix, which are not clearly visible or explicitly defined in the matrix itself.

Applying SVD, the matrix A is decomposed into the product of three matrices,

$$A = U \cdot S \cdot V^T, \quad (3.9)$$

where $U \in \mathbb{R}^{m \times m}$ and $V \in \mathbb{R}^{n \times m}$. The columns of U and V^T are singular vectors of A , which form the bases of the decomposition¹. S is a diagonal matrix whose non-zero elements are singular values. Applying SVD on the calibration samples (blue dots in Fig. 3.2(b)), the singular value of each SVD mode is obtained and shown in Fig. 3.6(a). It can be seen that the first few SVD modes have relatively large singular values, in other words, they are the dominant patterns of matrix A . The correlation coefficients of all SVD modes decomposed from the calibration samples are calculated as shown in Fig. 3.6(b). The first SVD mode has relatively strong correlations with the third and the fourth SVD mode. This is because the mean of the 49 calibration waveforms is not zero as shown in Fig. 3.7(a).

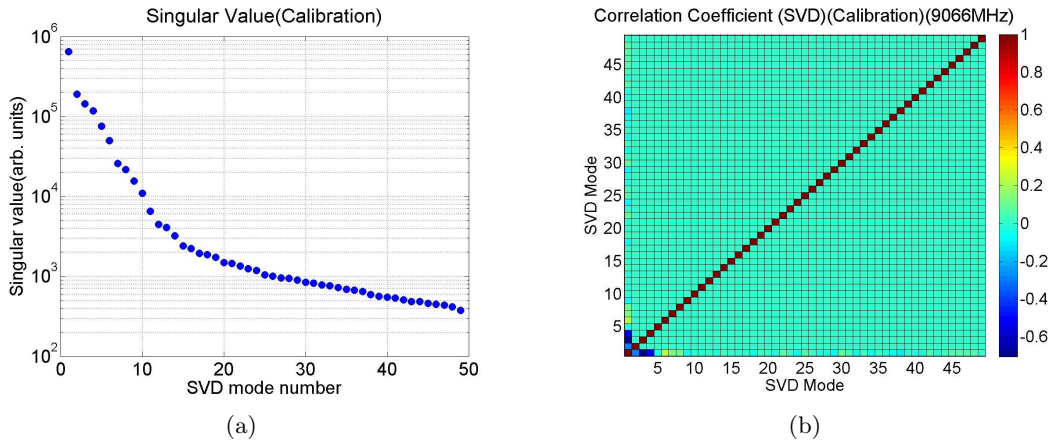

Figure 3.6: (a) Singular values of SVD modes; (b) Correlation coefficients of SVD modes decomposed from the calibration samples.

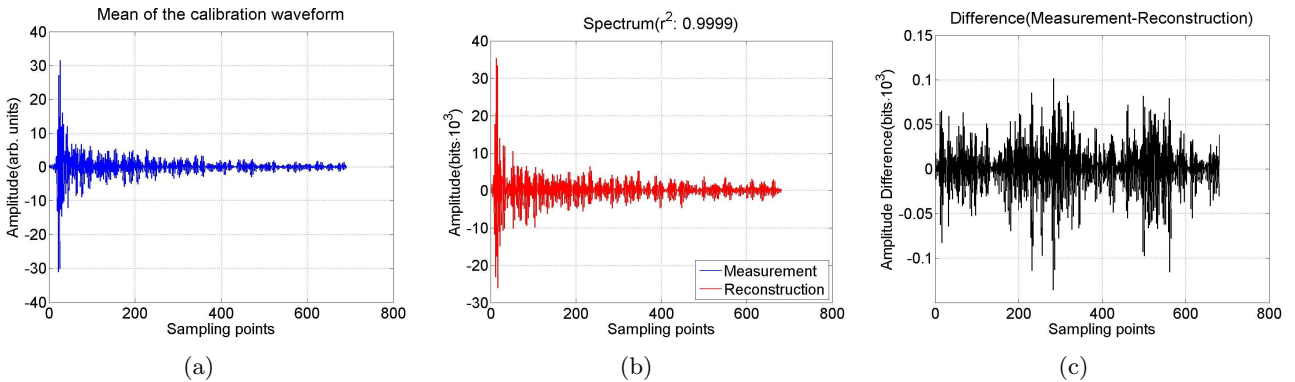

Figure 3.7: (a) Mean of the calibration waveforms; (b) Reconstructed waveform (red) from the first twelve SVD modes compared with original waveform (blue). (c) Difference of the original and reconstructed waveform.

¹In general case, $U \in \mathbb{R}^{m \times m}$, $S \in \mathbb{R}^{m \times n}$ and $V \in \mathbb{R}^{n \times n}$. However, in the case of $m < n$, only the first m SVD modes have non-zero singular values.

Each of the SVD modes can be used to produce a spectra matrix by

$$A_i = U_i \cdot S_{ii} \cdot V_i^T, \quad (3.10)$$

where U_i is the i^{th} column of U , and V_i^T is the i^{th} row of V^T . S_{ii} denotes the i^{th} diagonal element of S . A_i has the same size as the original spectra matrix A . Fig. 3.8 shows one spectrum for each of the first twelve A_i 's. The approximation A_{reco} can be calculate by simply summing over the related A_i by

$$A_{reco} = \sum_{i=1}^p A_i. \quad (3.11)$$

By combining the first twelve SVD modes ($p = 12$), A_{reco} is plotted together with the original spectra matrix A in Fig. 3.7(b) and the difference of A and A_{reco} is shown in Fig. 3.7(c). The spectrum can be well represented by using only the first twelve SVD modes.

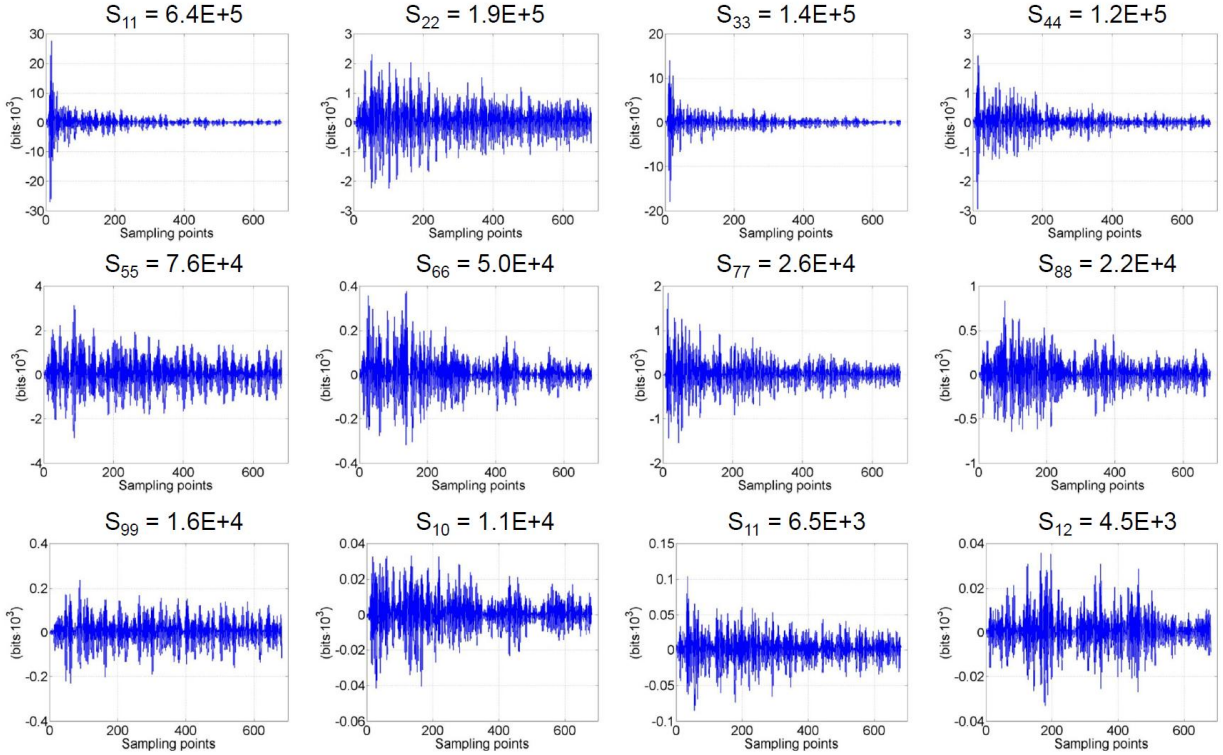

Figure 3.8: Spectra reconstructed from each of the first twelve SVD modes.

Having the SVD base vectors from the decompositions of spectra matrix A , the amplitude of all SVD modes, $A_{svd,full}$, can be obtained for each beam movement by

$$A_{svd,full} = A \cdot V \quad (3.12)$$

The first twelve columns of the matrix $A_{svd,full}$ constitute the matrix A_{svd} along with one column of 1 representing the intercept term. The size of the matrix A_{svd} is significantly smaller (13 columns, representing 12 SVD modes and one intercept term) compared to the original matrix A (701 columns, representing 700 sampling points and one intercept term). Replacing A by A_{svd} in the regression (Eq. 3.1), the linear system composed by A_{svd} and B is now over-determined, which has a well-known best solution in least-square sense. The position prediction B_{pre} can then be obtained using Eq. 3.6 by replacing A with A_{svd} for calibration samples. The prediction for the validation samples has two steps: first, project A onto the base vectors obtained from calibration samples to get the amplitude of the first twelve SVD modes using Eq. 3.12; second, substitute the SVD amplitude matrix in Eq. 3.6 to get the position prediction.

The contribution of combining the first p SVD modes to determine the transverse beam position x and y is measured by rms prediction error as shown in Fig. 3.9. Using the first twelve SVD modes is seen to

give an optimal performance for the x plane. It is also a reasonable choice for the y plane (Fig. 3.9(b)) even though less SVD modes would be sufficient. This confirms, with Fig. 3.6(a) and Fig. 3.7(b), that the first few modes contain most of the information. By combining the first twelve SVD modes, one can get the majority of beam position information.

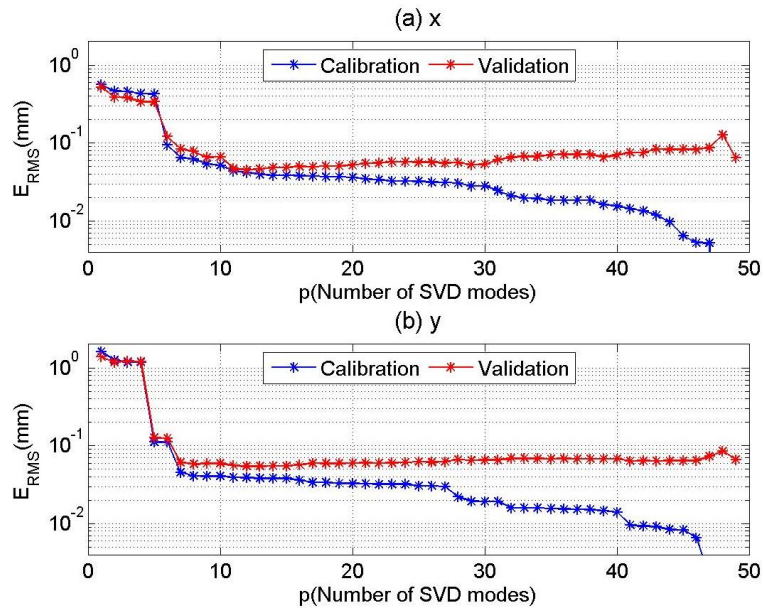

Figure 3.9: Contribution of the first p SVD modes to determine the transverse beam position x and y measured by the E_{RMS} .

Fig. 3.10 shows the HOM response from calibration and validation samples by using the first twelve SVD modes to determine the transverse beam position x and y . The prediction errors remain small and comparable for calibration and validation samples as shown in Fig. 3.11. The position resolution is $45 \mu\text{m}$ for x and $55 \mu\text{m}$ for y .

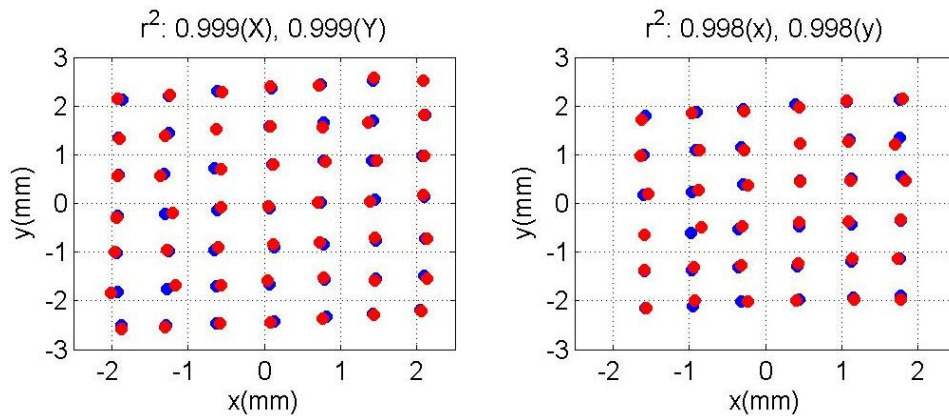

Figure 3.10: Measurement (blue) and prediction (red) of the transverse beam position from calibration (left) and validation (right) samples. The applied method is SVD with the first twelve SVD modes.

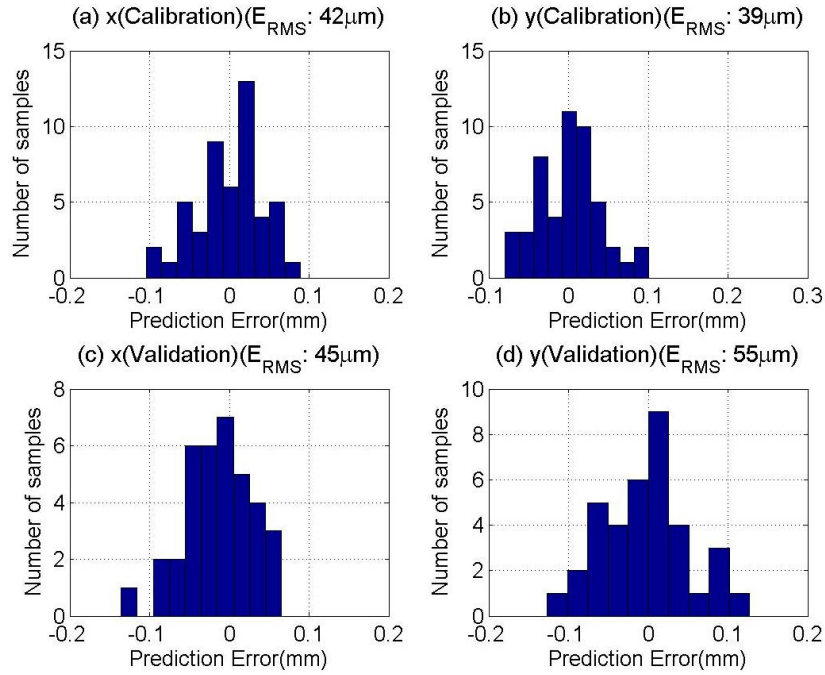

Figure 3.11: Difference of measured and predicted transverse beam position from calibration and validation samples. The applied method is SVD with the first twelve SVD modes. The position resolution is denoted as rms value on each plot.

3.4 Comparison of DLR and SVD

A direct comparison of DLR and SVD on the same samples (split as Fig. 3.2(b)) is shown in Fig. 3.12. The results obtained by the two different methods are similar. The comparisons of the rms prediction errors are listed in Table. 3.1.

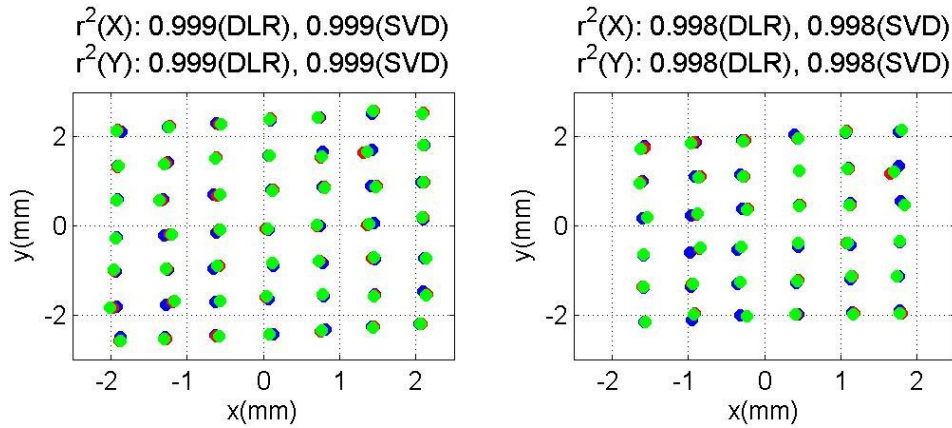

Figure 3.12: Measurement (blue) and prediction of the transverse beam position from calibration (left) and validation (right) samples. The applied method is DLR (red) and SVD with the first twelve SVD modes (green).

Until now, our analysis is based on a specific sample split (Fig. 3.2(b)). To remove sample dependence, a technique namely *cross-validation* is used [32]. As in the discussed example the total sample size is only 85 (49 calibration positions plus 36 validation positions), one can apply the *leave-one-out cross-validation* (LOOCV) [32] technique. LOOCV uses only one from the total samples for the validation and the remainings as calibrations as shown in Fig. 3.13(a) for one example. This is repeated for every sample (85 times in the considered case). Fig. 3.13(b) shows the measurement and the prediction of each validation sample. The method we used is SVD with the first 12 SVD modes. The rms prediction error is then calculated on the prediction error for the validation sample from all 85 different sample splits. The sample-independent rms

Table 3.1: Comparison of rms prediction errors of DLR and SVD corresponding to Fig. 3.4 and Fig. 3.11.

	x (μm)	y (μm)
Calib(DLR)	41	39
Calib(SVD)	42	39
Valid(DLR)	47	56
Valid(SVD)	45	55

prediction error is $50 \mu\text{m}$ for x and $52 \mu\text{m}$ for y . Fig. 3.14 shows the sample-independent rms error using the first p SVD modes. Similar to the case of sample split shown in Fig. 3.2(b), the first 12 SVD modes give an optimal prediction accuracy for x and even less SVD modes (the first 7) are needed for y . Since the calibration samples for each of the 85 splits are similar, the sample-independent rms error for the validations is a good estimation of the position resolution. The results are similar compared with the fixed sample split case shown in Table 3.1.

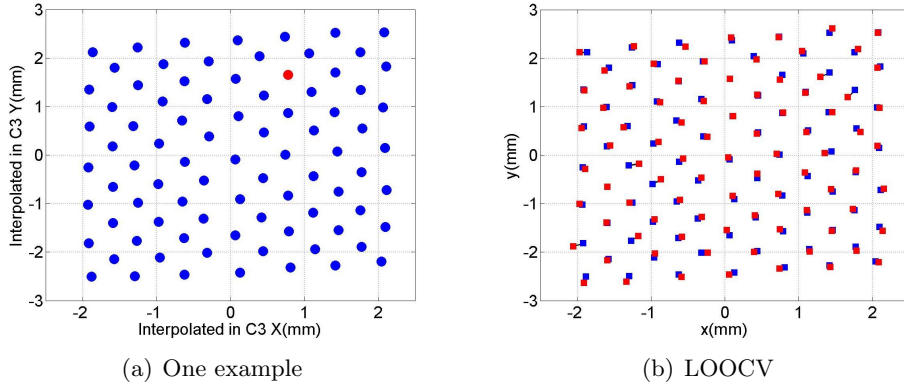

Figure 3.13: (a) Calibration (blue) and validation (red) samples from one of the 85 sample splits during the cross validation. (b) Measurement (blue) and prediction (red) of the transverse beam position from each of the 85 sample splits using the cross validation.

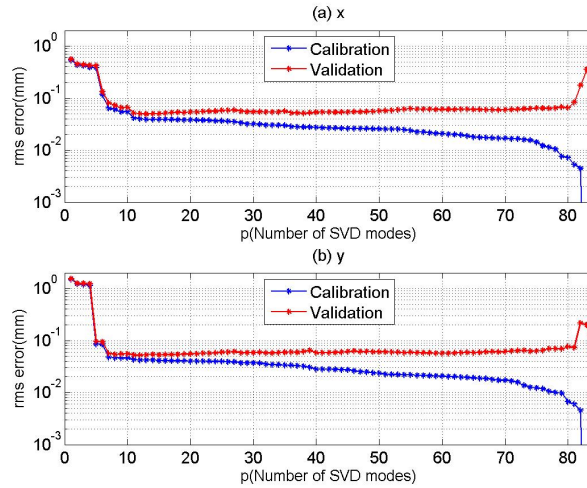

Figure 3.14: Contribution of the first p SVD modes to determine the transverse beam position x and y measured by the sample-independent rms prediction error.

Chapter 4

Position Resolutions

Resolutions for the position determination using various modes are discussed in this chapter. Only one set of modes for each modal option (Table 2.1) is described. The data obtained by the VME digitizer are used for the first two cavity dipole bands and the fifth cavity dipole band, while the μ TCA digitizer is used for the beam-pipe modes. The selection is based on data availability for this set of measurements¹. The data analysis technique used in this chapter is SVD as explained in Chapter 3. The number of SVD modes for regression is determined based on a stable and good position resolution. The results for the first (C1H2) and the last (C4H2) HOM coupler in the four-cavity string are excluded in this chapter. HOM coupler C1H2 picks up the modes transmitted from the first accelerating module, while C4H2 has weak signals. Both the time-domain waveforms and frequency-domain fft amplitudes are studied. The frequency domain is used for comparisons with previous studies using a real-time spectrum analyzer. In general, time-domain signals give better position resolution than frequency-domain fft amplitudes. This proves that the phase information is crucial for the beam position determination. A full list of resolutions for all modes studied with the test electronics can be found in Appendix C along with the number of SVD modes used for a stable and good position determination presented in Appendix D.

4.1 The Localized Beam-pipe Dipole Modes

The LO was set to downconvert 4118 MHz to 70 MHz, and a 20 MHz BPF was then applied to the down-converted signal. Fig. 4.1 shows the down-converted signal after it was processed with the μ TCA digitizer, in both the time- and frequency domain (after a fft). As mentioned in the previous chapter, the mathematical ideal filter is applied to the down-converted time-domain waveform for cutting away the other modes after the down-conversion. The final filtered signal is shown as red in Fig. 4.1. Compared with the spectrum analyzer signal obtained in previous studies [20], the displayed signal filtered from 4100 MHz to 4133 MHz has proved to contain the dipole modes localized in the beam pipes. As the BPF was set to 70 MHz with a 10 MHz bandwidth on each side, the main component of the filtered signal is from 4108 MHz to 4128 MHz. The IF signal is undersampled with the 108 MS/s μ TCA digitizer.

To determine the beam position, we considered both the time-domain and the frequency-domain (the fft amplitude, discard fft phase) signal. They are shown as red waveform and red spectrum in Fig. 4.1 for one example. The samples have been split in a fixed manner as shown in Fig. 2.8(a) along with a LOOCV case. The position resolution for these modes is shown in Fig. 4.2(a) for time-domain waveform and Fig. 4.2(b) for frequency-domain fft amplitude along with the number of SVD modes used in the respective regression. One may notice that the number of SVD modes is similar for coupler C2H2 and C3H2. Both of these two couplers see clearly orthogonal polarizations of these two peaks from previous studies [20, 22].

¹The VME digitizer was unavailable when measuring the beam-pipe modes due to technical problems.

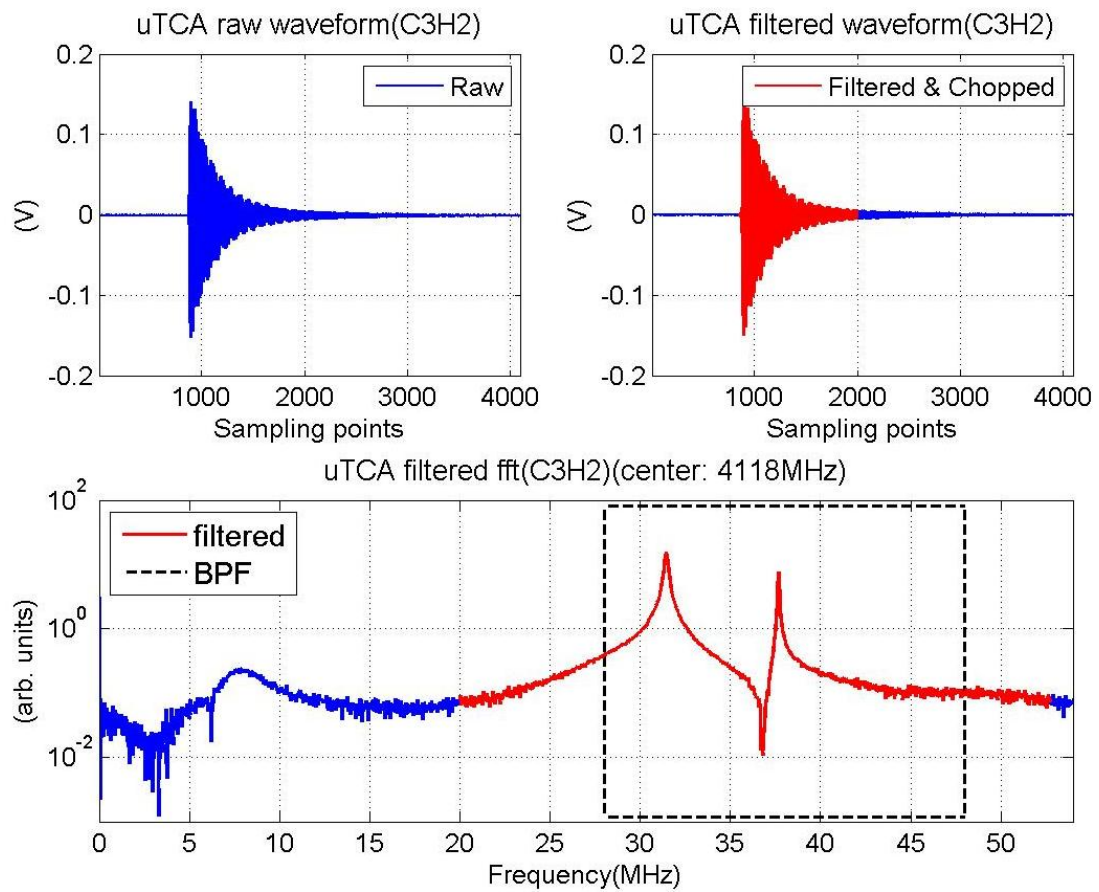

Figure 4.1: HOM signal. The center frequency is 4118 MHz with a 20 MHz BPF.

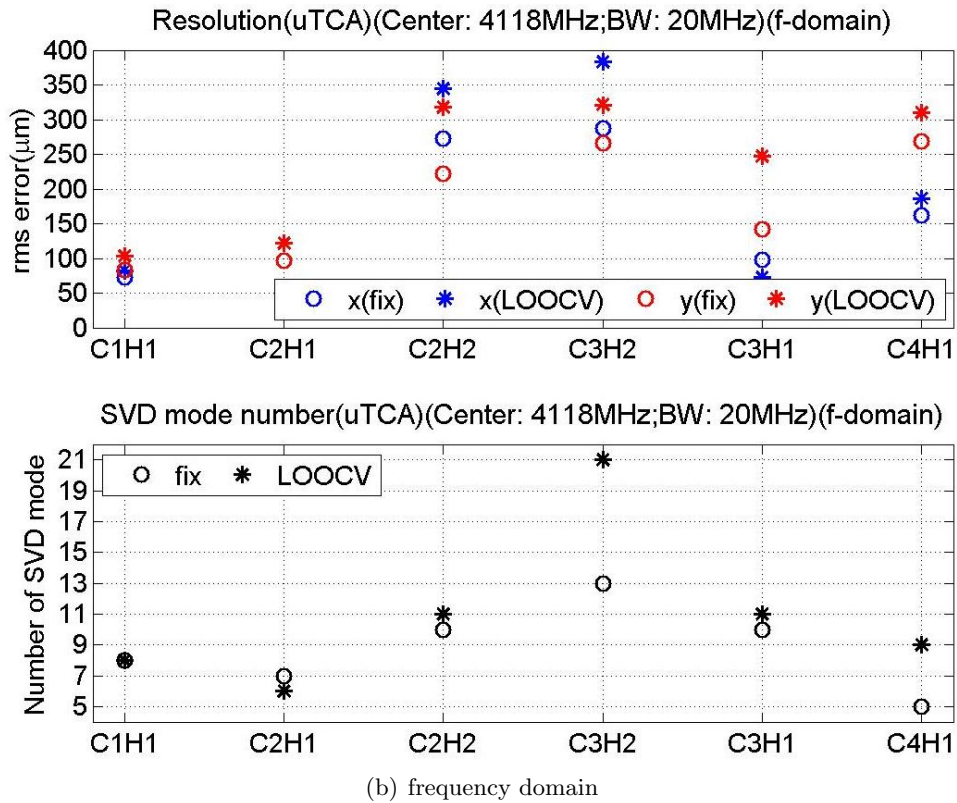
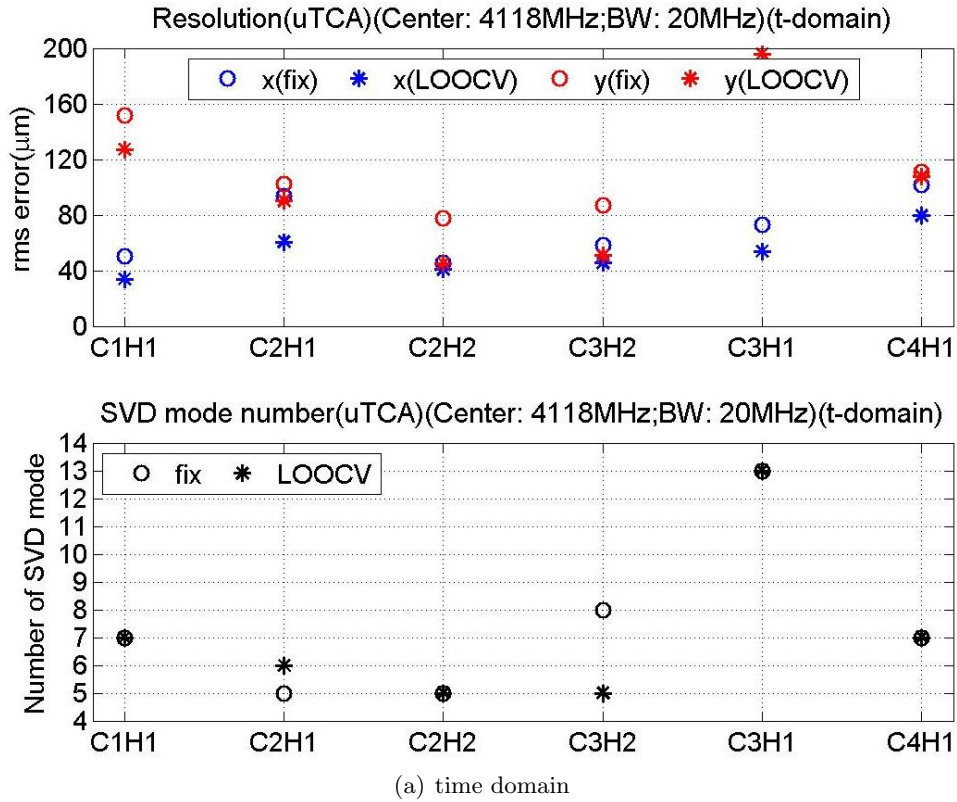

Figure 4.2: Position resolution and SVD mode number used for position determination for both time-domain and frequency-domain. The center frequency is 4118 MHz with a 20 MHz BPF.

The integrated power over the frequency range shown in Fig. 4.1 (red spectrum) is calculated for each beam position. Fig. 4.3 shows the integrated power distribution for each HOM coupler. The position, which has minimum integrated power, is marked with white pentagon. Neither the power distribution nor the power minimum is similar among couplers. This might be a proof that modes are localized inside each beam pipe presented in the frequency region for power integration. It might also be an implication of different electrical axes for individual cavities. This difference can be attributed to asymmetric structure due to couplers and fabrication tolerance of the cavities. Fig. 4.4 decomposes the power distribution plot into horizontal and vertical moves.

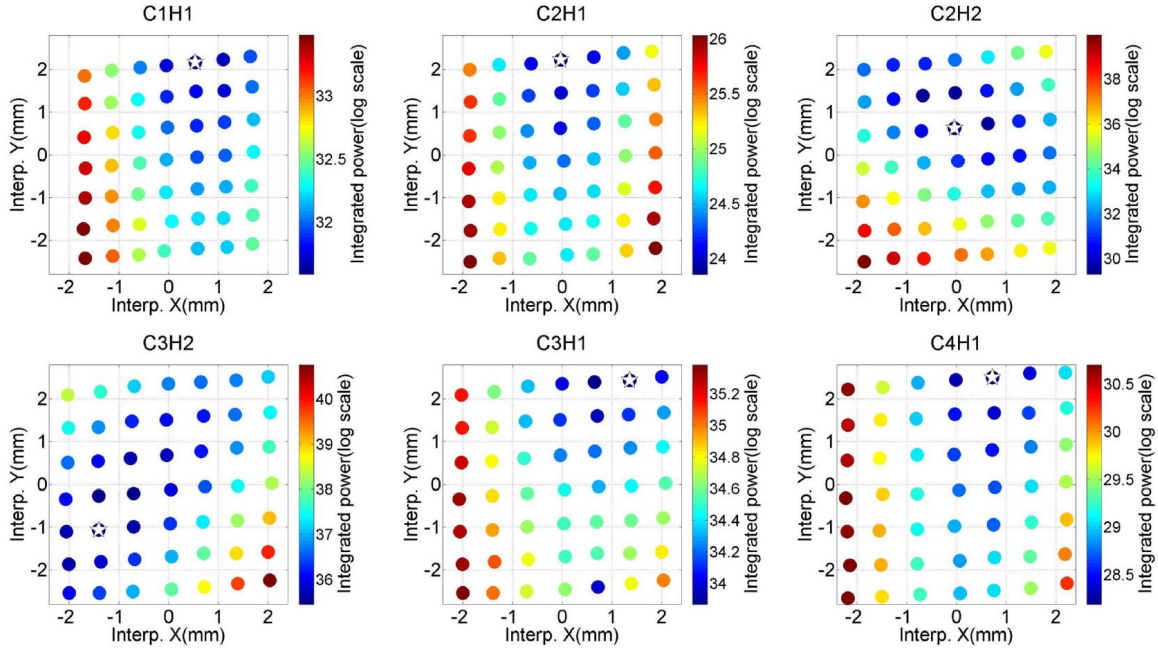

Figure 4.3: Integrated power as a function of transverse position interpolated in each cavity. The log scale magnitude of power is denoted by different color. The minimum power is marked with white pentagon. The center frequency is 4118 MHz with a 20 MHz BPF.

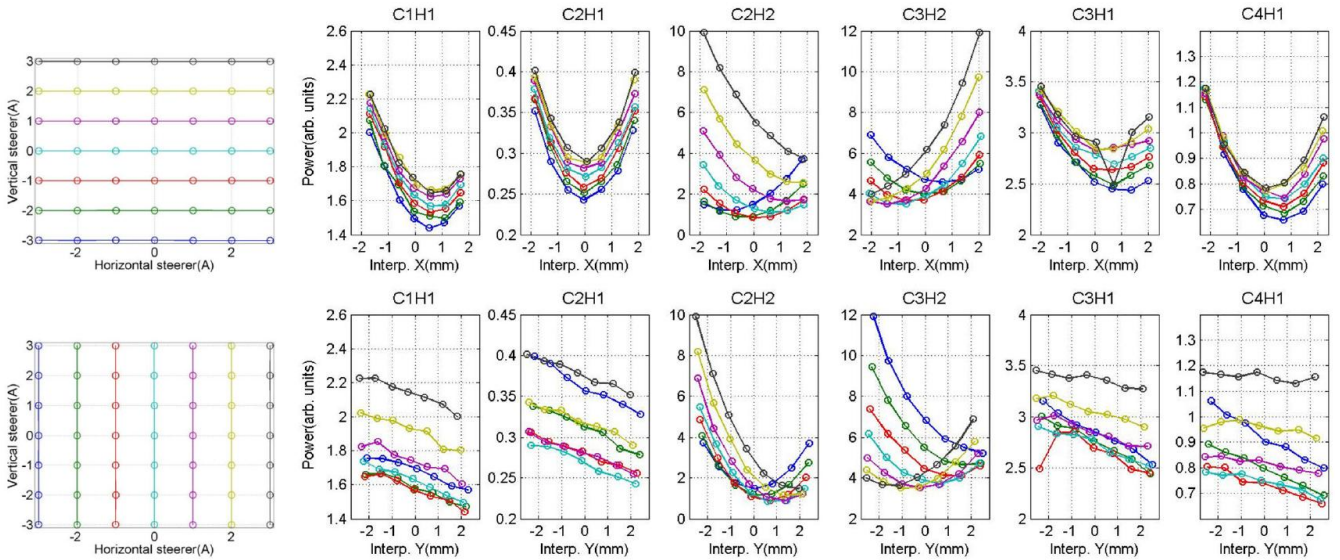

Figure 4.4: Integrated power as a function of transverse position interpolated in each cavity. The center frequency is 4118 MHz with a 20 MHz BPF.

4.2 Coupled Cavity Modes - The First Dipole Band

The LO was set to downconvert 4940 MHz to 70 MHz, and a 20 MHz BPF was then applied to the down-converted signal. Fig. 4.5 shows the down-converted signal after it was processed by the VME digitizer, in both time- and frequency domain (after a fft). Modes in this band are coupled, therefore, the mathematical ideal filter is used only to preserve good signal quality as shown in Fig. 4.5. Compared with the spectrum analyzer signal obtained in previous studies [20], the displayed signal filtered from 4903 MHz to 5009 MHz has proved to contain dipole modes propagating amongst cavities. As the BPF was set to 70 MHz with a 10 MHz bandwidth on each side, the main component of the filtered signal is from 4930 MHz to 4950 MHz.

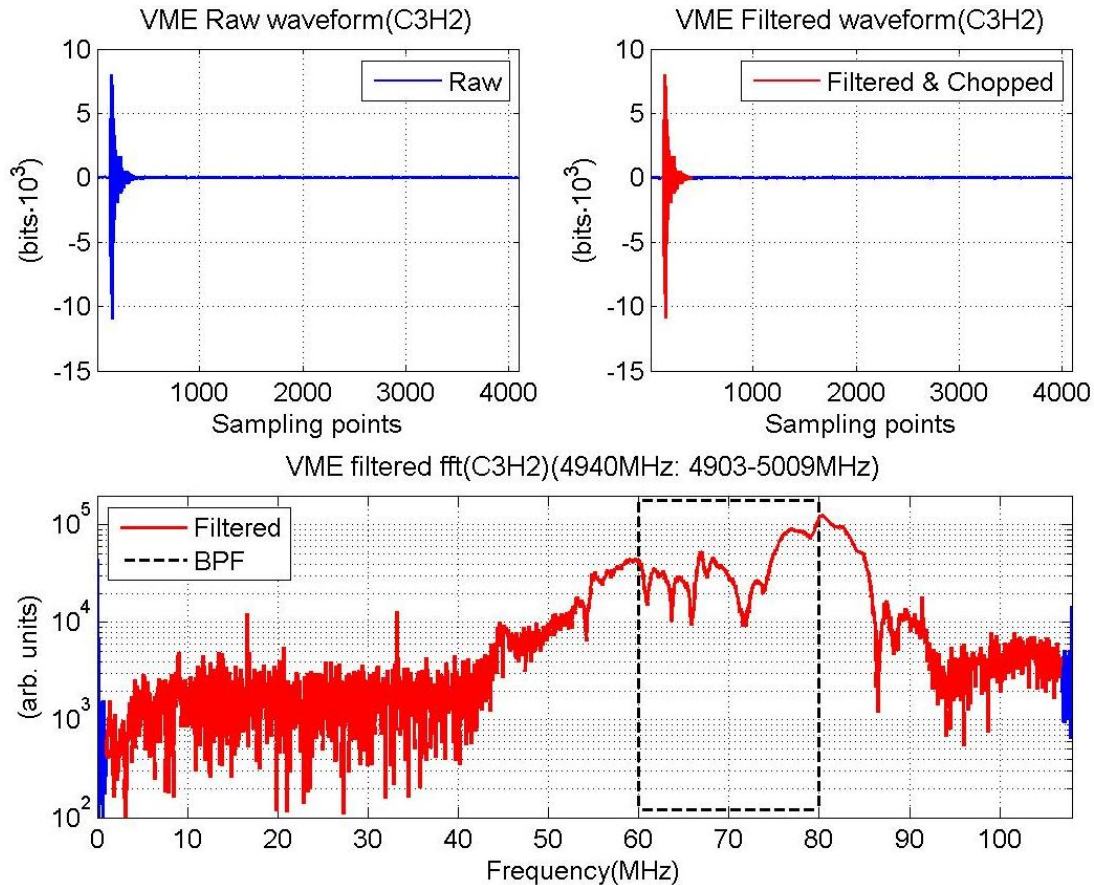

Figure 4.5: HOM signal. The center frequency is 4940 MHz with a 20 MHz BPF.

The position resolution of this band is shown in Fig. 4.6(a) for time-domain waveform and Fig. 4.6(b) for frequency-domain fft amplitude along with the number of SVD modes used in the respective regression. The resolution of y is approximately two times worse than that of x for time-domain, which is not understood.

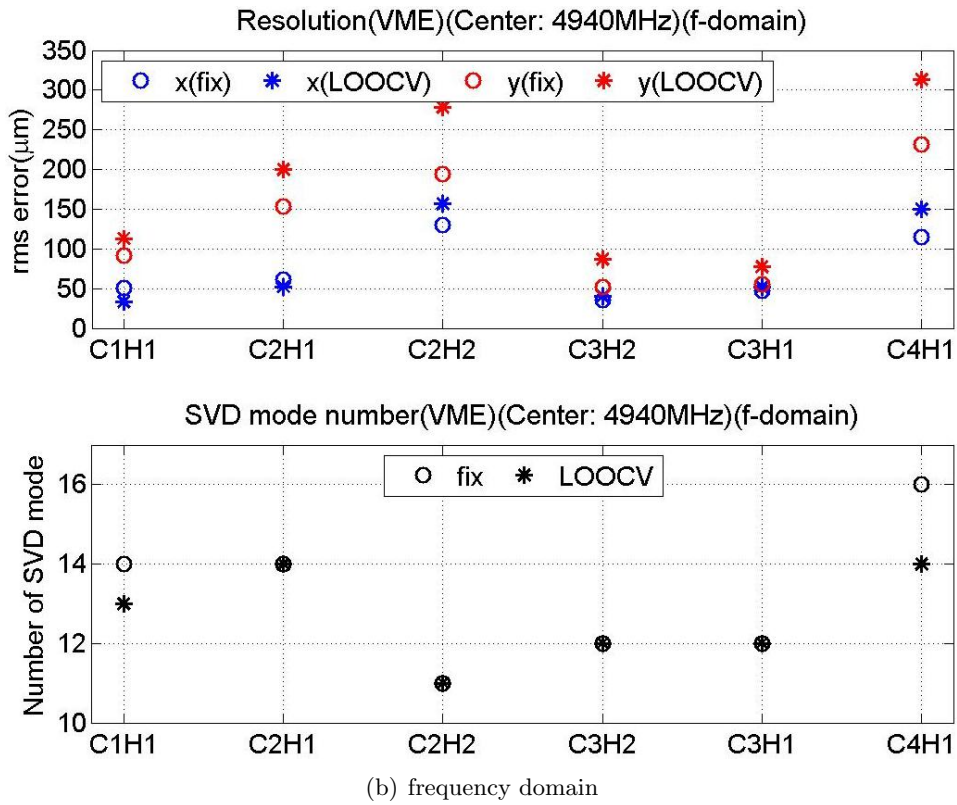
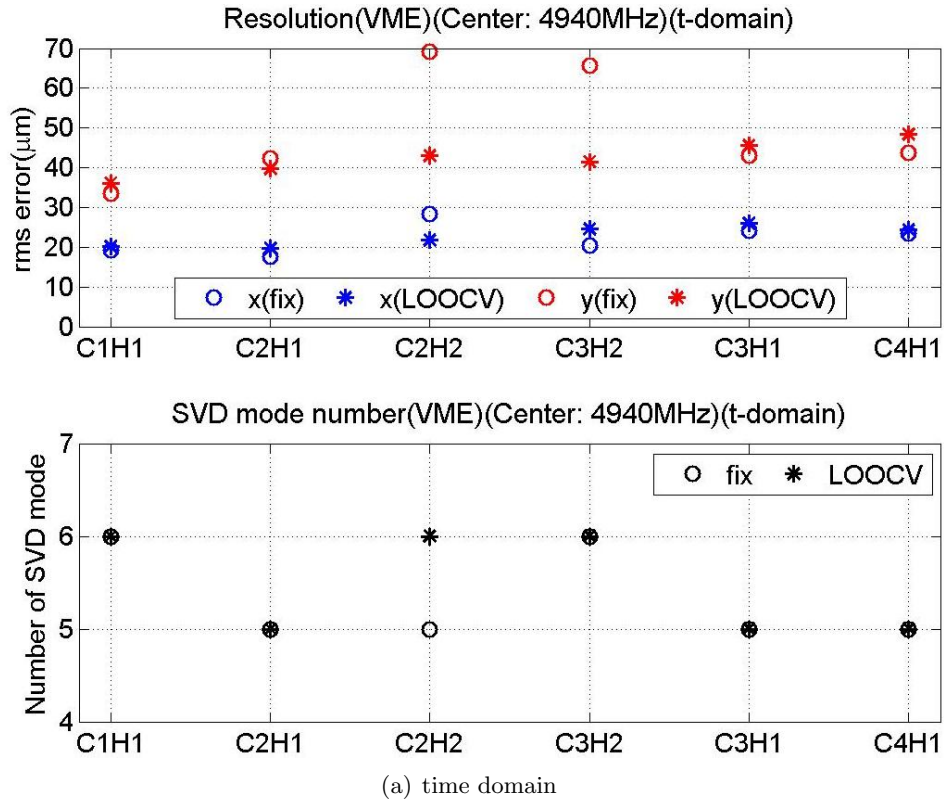

Figure 4.6: Position resolution and SVD mode number used for position determination for both time-domain and frequency-domain. The center frequency is 4940 MHz with a 20 MHz BPF.

The integrated power over the frequency range shown in Fig. 4.5 (red spectrum) is calculated for each beam position. Fig. 4.7 shows the integrated power distribution for each HOM coupler. The position, which has minimum integrated power, is marked with white pentagon. A dissimilar position of the power minimum is found for each of the six HOM couplers. This might be due to different coupling of individual coupler and the longitudinal field distribution of the various modes. Fig. 4.8 decomposes the power distribution plot into horizontal and vertical moves.

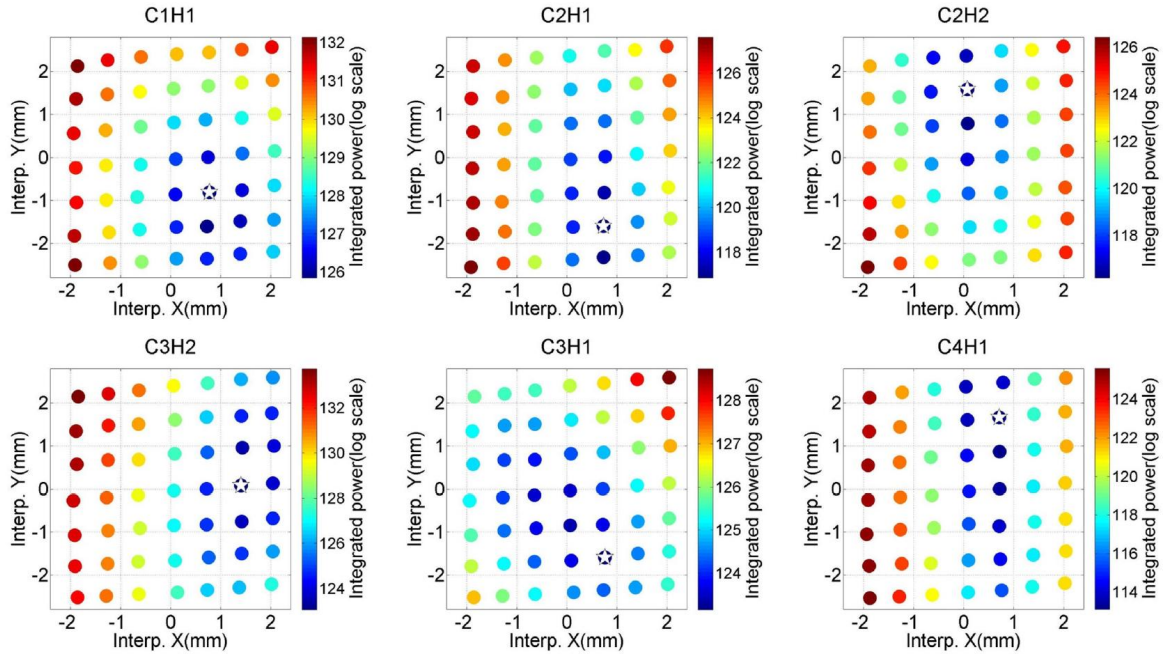

Figure 4.7: Integrated power as a function of transverse position interpolated in each cavity. The log scale magnitude of power is denoted by different color. The minimum power is marked with white pentagon. The center frequency is 4940 MHz with a 20 MHz BPF.

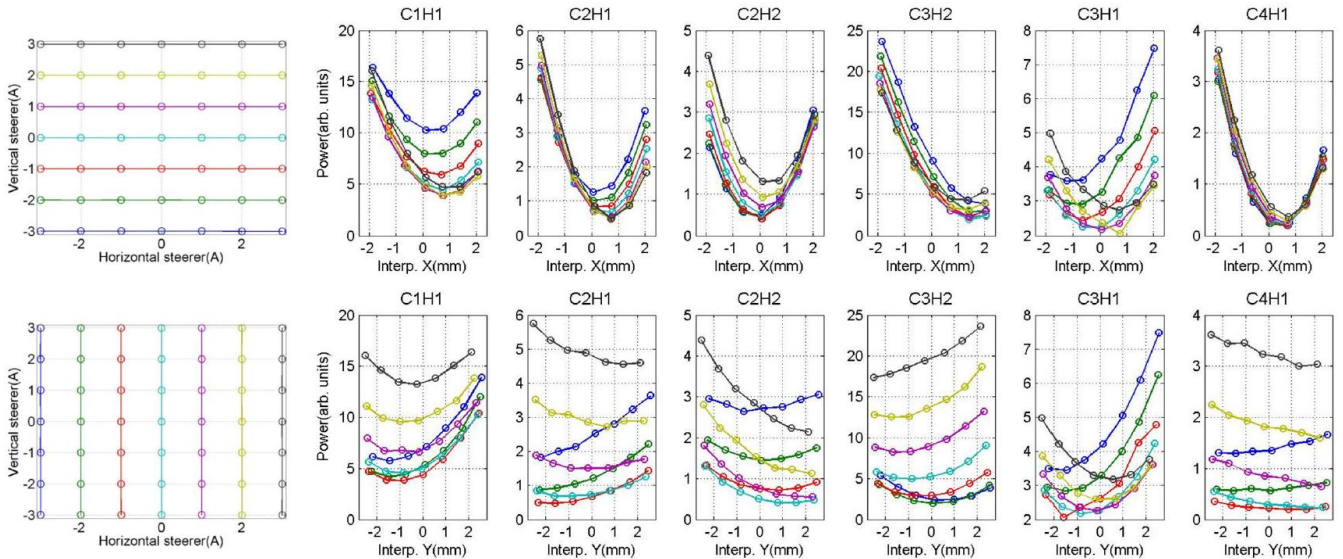

Figure 4.8: Integrated power as a function of transverse position interpolated in each cavity. The center frequency is 4940 MHz with a 20 MHz BPF.

4.3 Coupled Cavity Modes - The Second Dipole Band

The LO was set to downconvert 5437 MHz to 70 MHz, and a 20 MHz BPF was then applied to the down-converted signal. Fig. 4.9 shows the down-converted signal processed by the VME digitizer, in both time- and frequency domain (after a fft). Modes in this band are coupled, therefore, the mathematical ideal filter is only to preserve good signal quality as shown in Fig. 4.9. Compared with the spectrum analyzer signal obtained in previous studies [20], the signal filtered from 5400 MHz to 5506 MHz has proved to contain dipole modes propagating amongst cavities. As the BPF was set to 70 MHz with a 10 MHz bandwidth on each side, the main component of the filtered signal is from 5427 MHz to 5447 MHz.

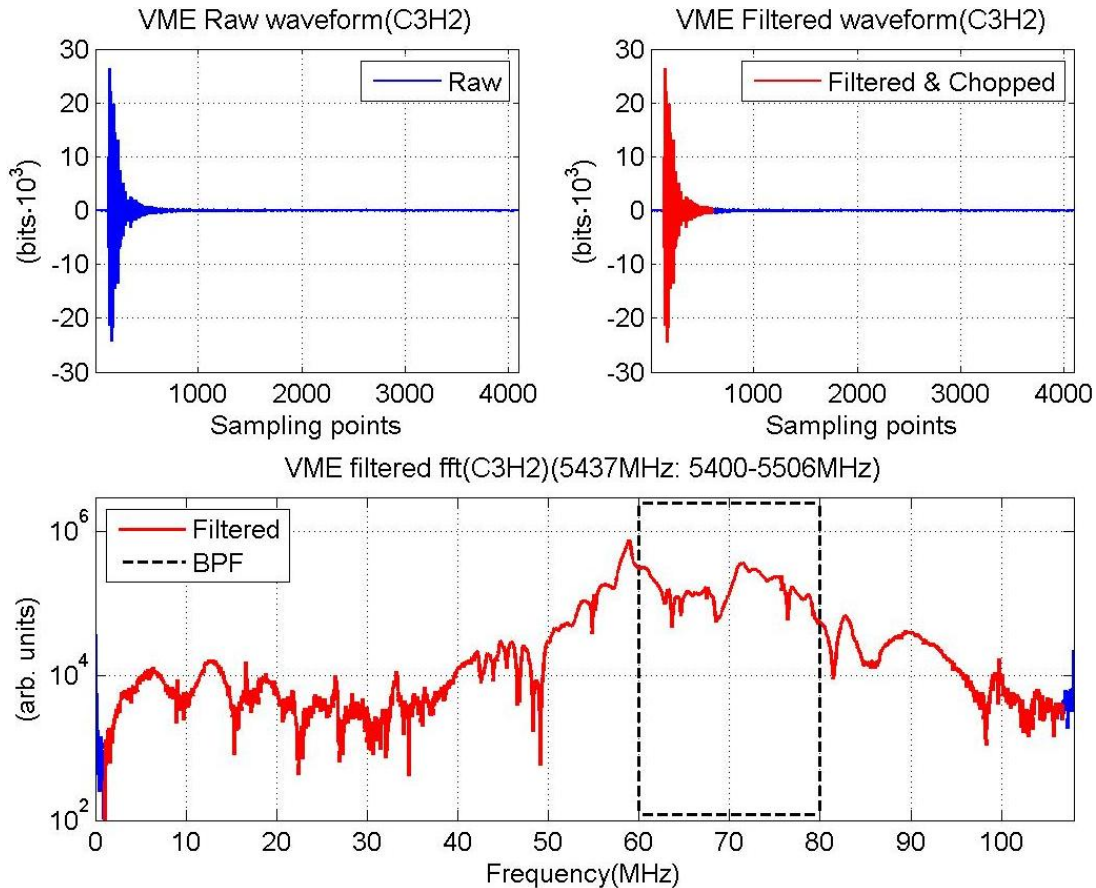
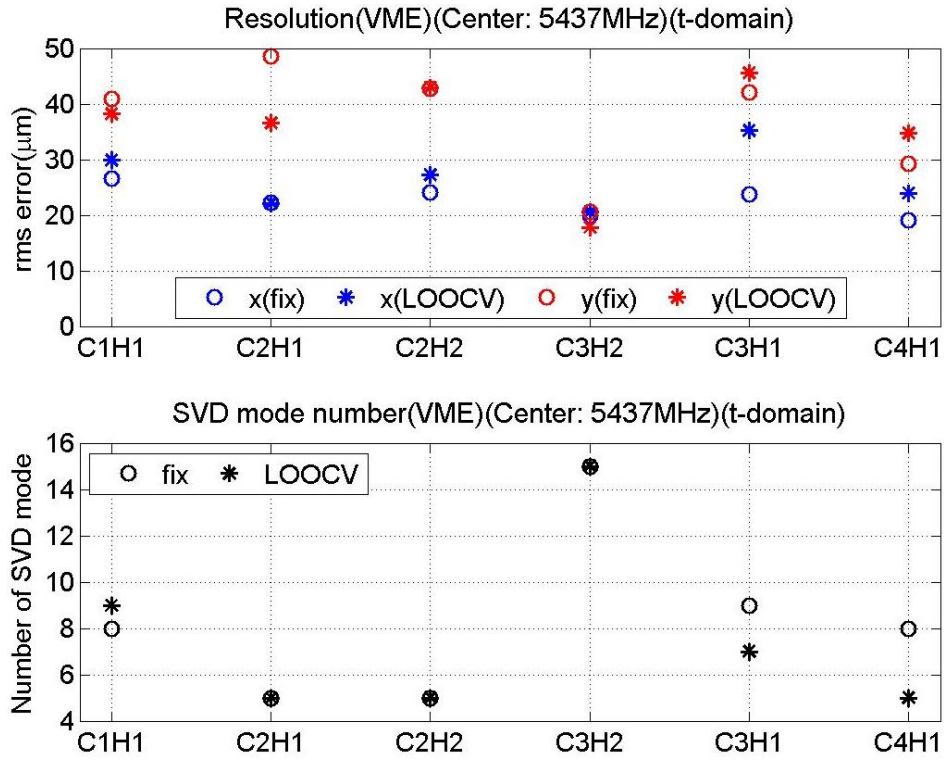
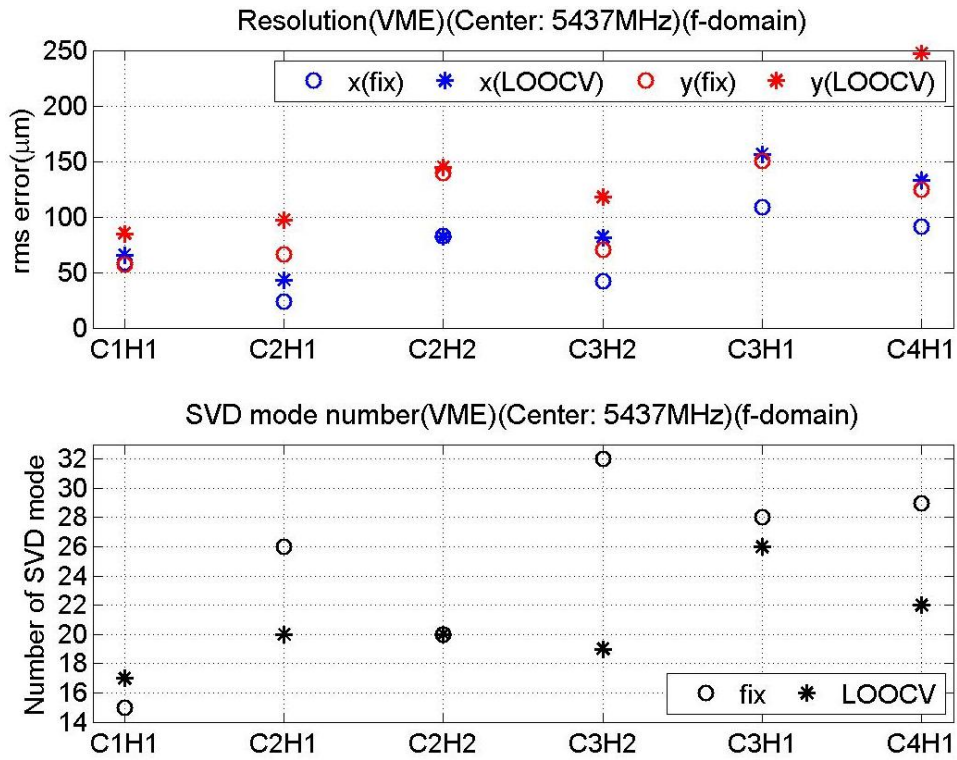

Figure 4.9: HOM signal. The center frequency is 9048 MHz with a 20 MHz BPF.

The position resolution of this band is shown in Fig. 4.10(a) for time-domain waveform and Fig. 4.10(b) for frequency-domain fft amplitude along with the number of SVD modes used in the respective regression. The resolution of y is approximately two times worse than that of x for time-domain. Although the modes are propagating, the HOM signal extracted from each coupler is still different due to the individual coupling effect of each coupler. This is reflected by the dissimilar number of SVD modes used to determine beam position.



(a) time domain



(b) frequency domain

Figure 4.10: Position resolution and SVD mode number used for position determination for both time-domain and frequency-domain. The center frequency is 5437 MHz with a 20 MHz BPF.

The integrated power over the frequency range shown in Fig. 4.9 (red spectrum) is calculated for each beam position. Fig. 4.11 shows the integrated power distribution for each HOM coupler. The position, which has minimum integrated power, is marked with white pentagon. A similar position of the power minimum can be found for all six HOM couplers. This might be a proof that modes are propagating through cavities presented in the frequency range for power integration. Fig. 4.12 decomposes the power distribution plot into horizontal and vertical moves. Around this “common” power-minimum position, we did a smaller scan as shown in Fig. 4.13. The position resolutions of $30 \mu\text{m}$ for x and $20 \mu\text{m}$ for y can be achieved using the signal from each of the six HOM couplers.

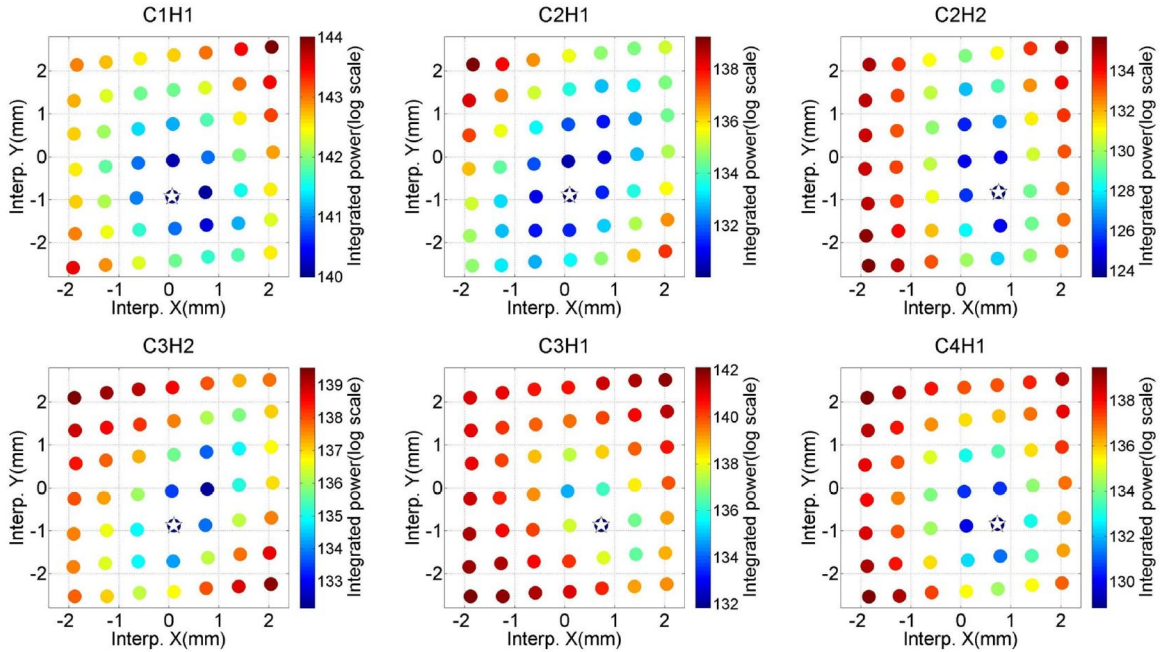

Figure 4.11: Integrated power as a function of transverse position interpolated in each cavity. The log scale magnitude of power is denoted by different color. The minimum power is marked with white pentagon. The center frequency is 5437 MHz with a 20 MHz BPF.

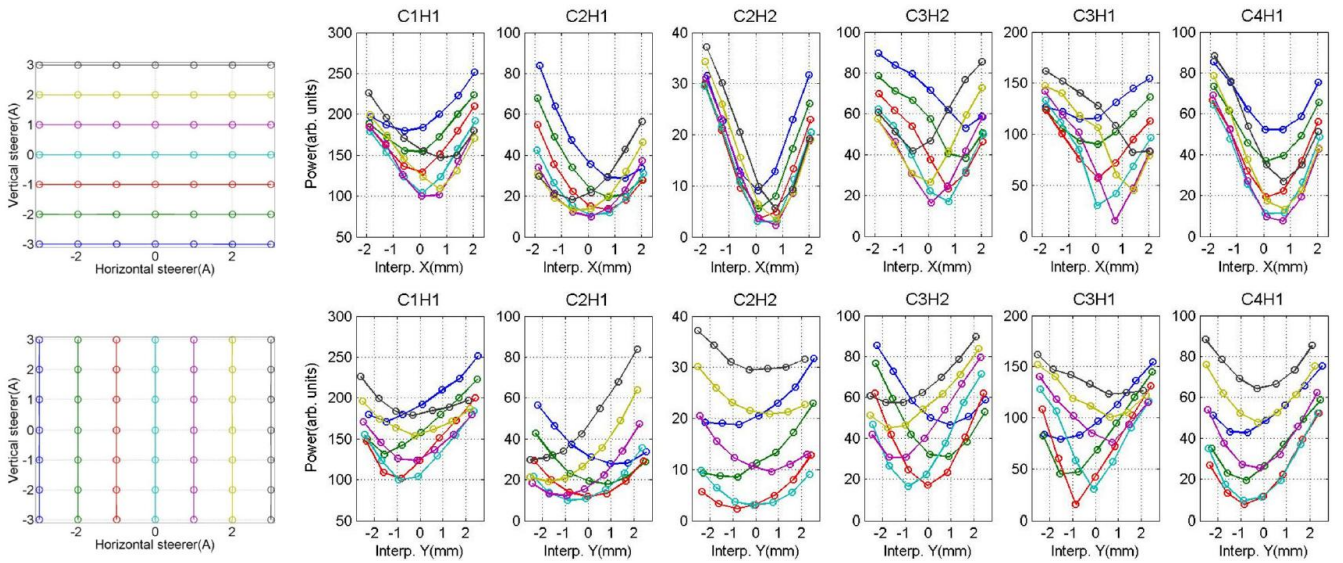

Figure 4.12: Integrated power as a function of transverse position interpolated in each cavity. The center frequency is 5437 MHz with a 20 MHz BPF.

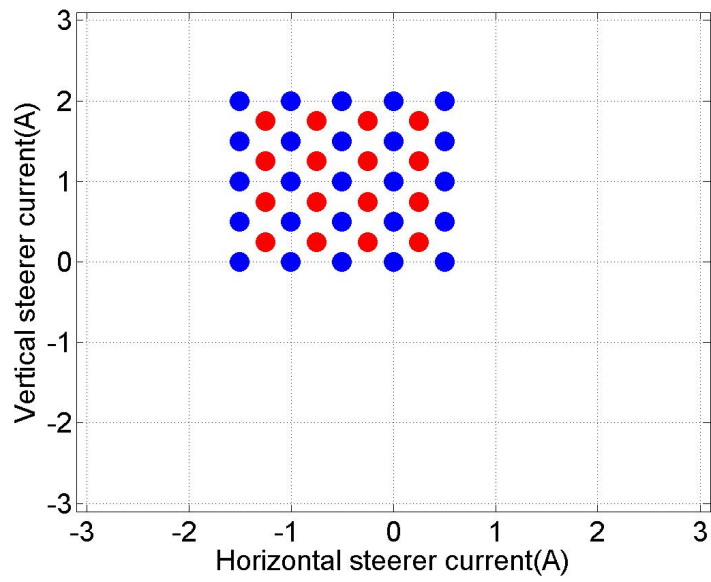

Figure 4.13: Smaller scan around the power minimum. The center frequency is 5437 MHz with a 20 MHz BPF.

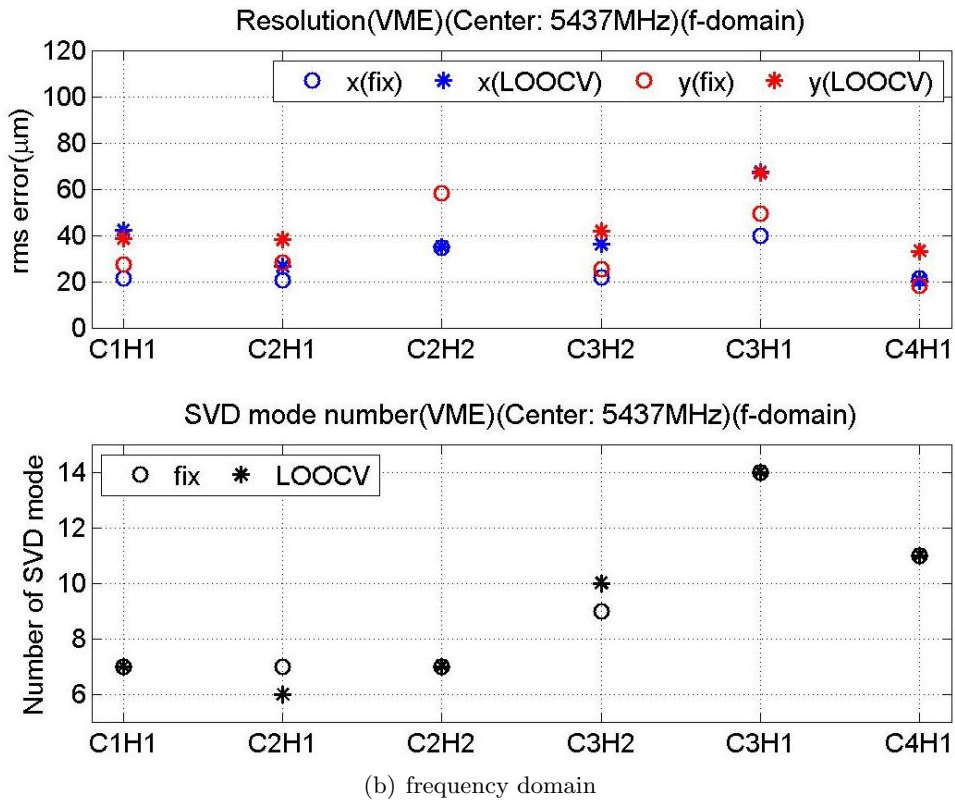
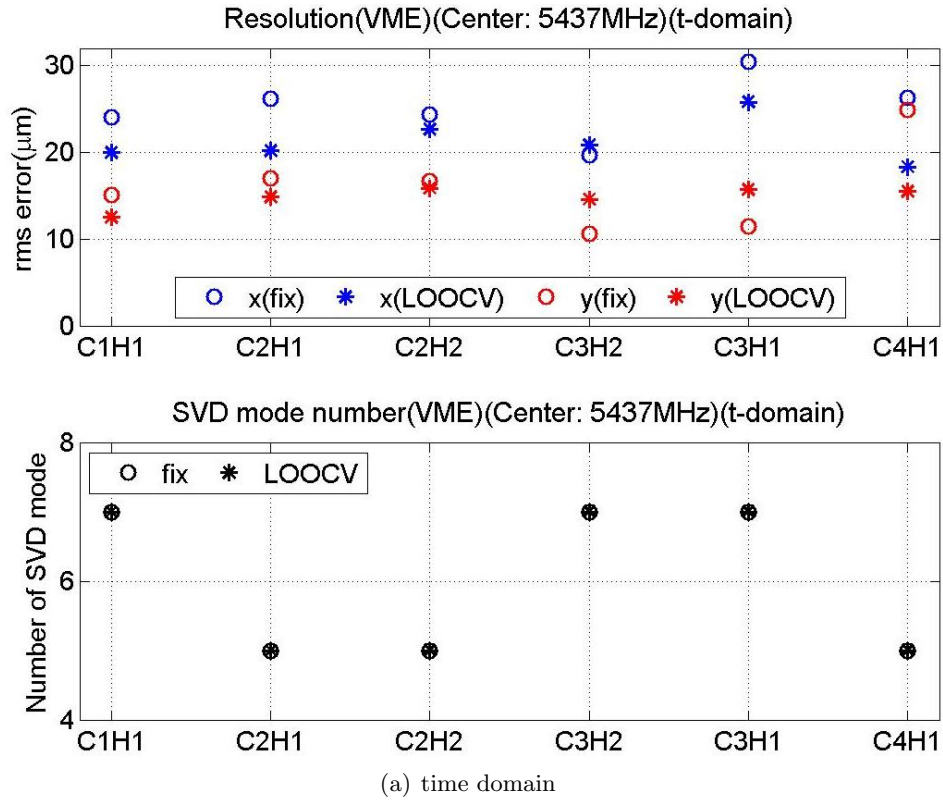

Figure 4.14: Position resolution and SVD mode number used for position determination for both time-domain and frequency-domain. The center frequency is 5437 MHz with a 20 MHz BPF.

4.4 Trapped Cavity Modes - The Fifth Dipole Band

The LO was set to downconvert 9066 MHz to 70 MHz, and a 20 MHz BPF was then applied to the down-converted signal. Fig. 4.15 shows the down-converted signal processed by the VME digitizer, in both time- and frequency domain (after a fft). According to the previous study [24], the double-peak at approximately 55 MHz are coupled modes. Therefore, we applied a mathematical ideal filter to the down-converted time-domain waveform and the filtered signal is shown as red in Fig. 4.15. Compared with the spectrum analyzer signal obtained in previous studies [20], the signal filtered from 9035 MHz to 9080 MHz has proved to contain dipole modes localized inside each cavity. As the BPF was set to 70 MHz with a 10 MHz bandwidth on each side, the main component of the filtered signal is from 9056 MHz to 9076 MHz.

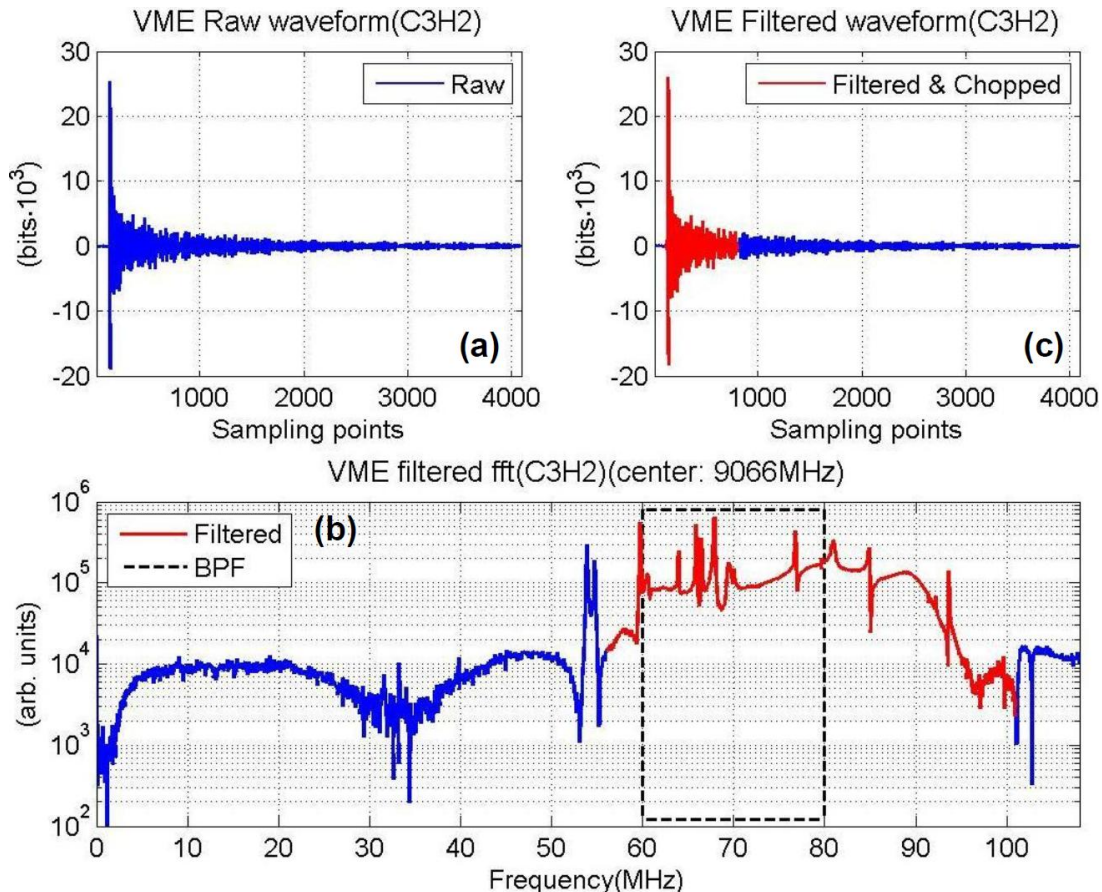

Figure 4.15: HOM signal. The center frequency is 9066 MHz with a 20 MHz BPF.

The position resolution of these modes is shown in Fig. 4.16(a) for time-domain waveform and Fig. 4.16(b) for frequency-domain fft amplitude along with the number of SVD modes used in the respective regression. The number of SVD modes is different for individual couplers due to the dissimilar HOM signal extracted from each coupler.

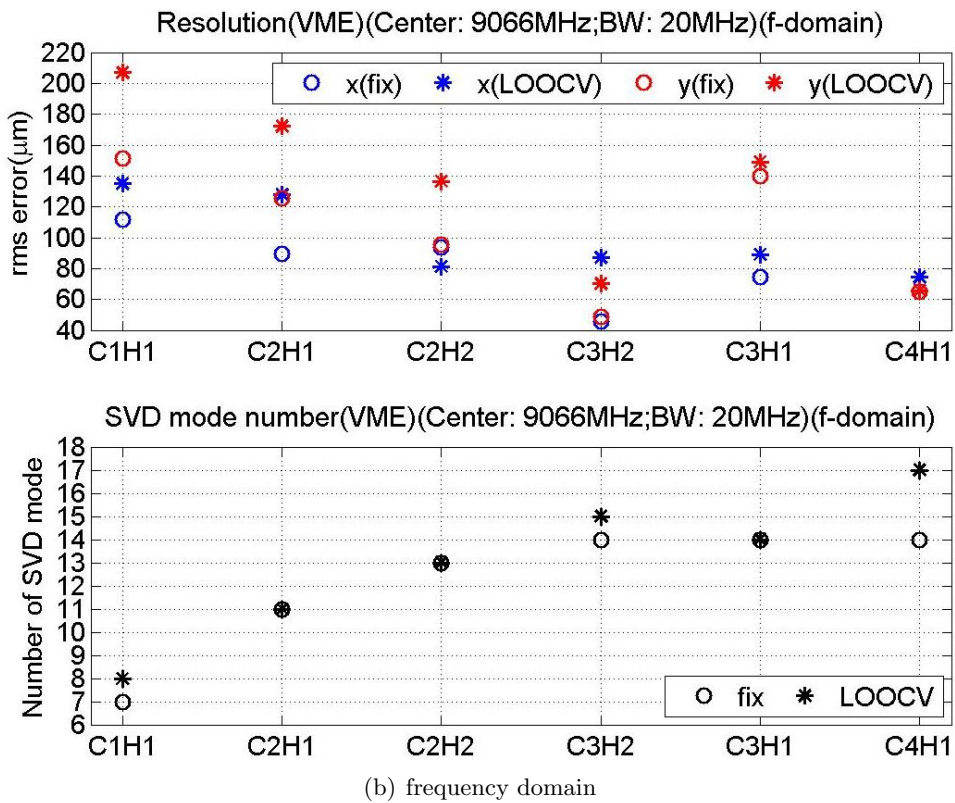
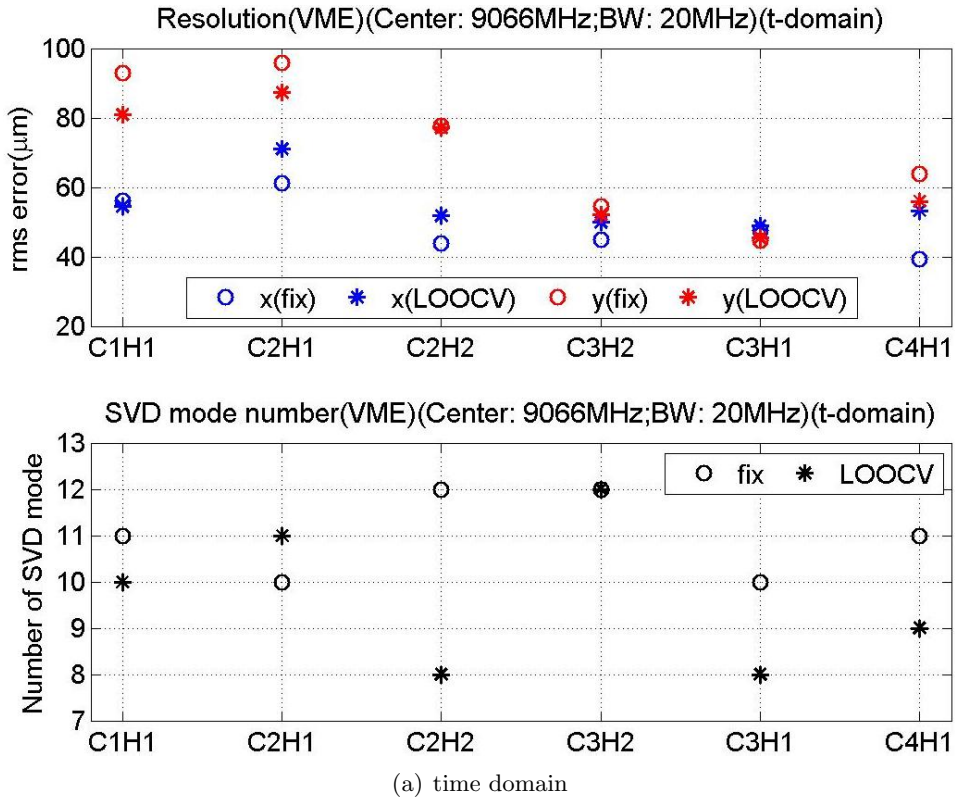

Figure 4.16: Position resolution and SVD mode number used for position determination for both time-domain and frequency-domain. The center frequency is 9066 MHz with a 20 MHz BPF.

The integrated power over the frequency range shown in Fig. 4.15 (red spectrum) is calculated for each beam position. Fig. 4.17 shows the integrated power distribution for each HOM coupler. The position, which has minimum integrated power, is marked with white pentagon. Neither the power distribution nor the power minimum is similar among couplers. This might be a proof that modes are trapped inside each cavity presented in the frequency range for power integration. It might also be an indication of different electrical axes for different dipole modes of individual cavities. This difference can be attributed to asymmetric structure due to couplers and fabrication tolerance of the cavities. Fig. 4.18 decomposes the power distribution plot into horizontal and vertical moves.

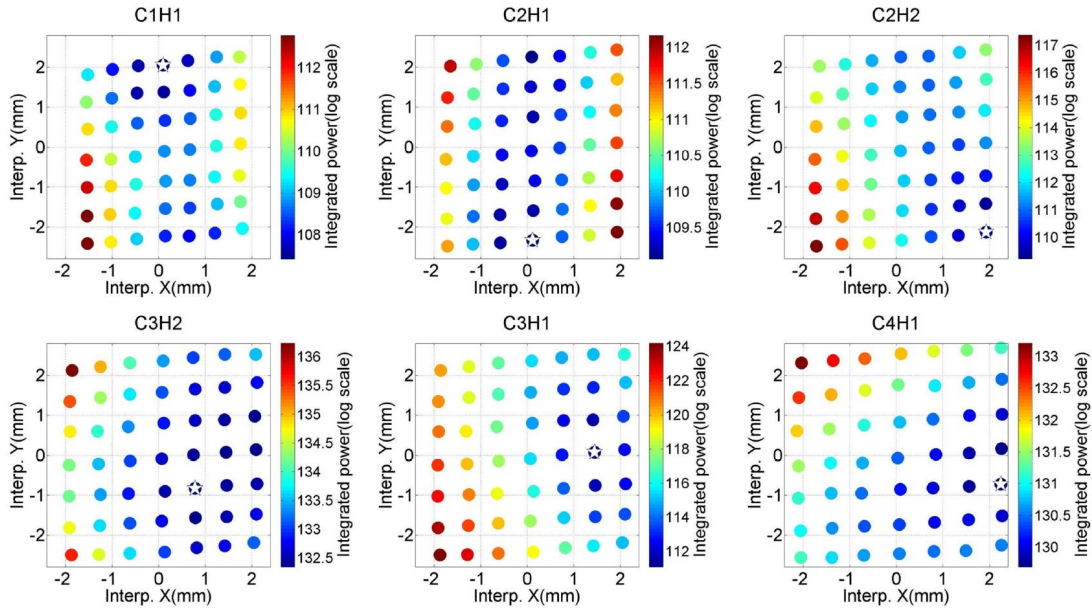

Figure 4.17: Integrated power as a function of transverse position interpolated in each cavity. The log scale magnitude of power is denoted by different color. The minimum power is marked with white pentagon. The center frequency is 9066 MHz with a 20 MHz BPF.

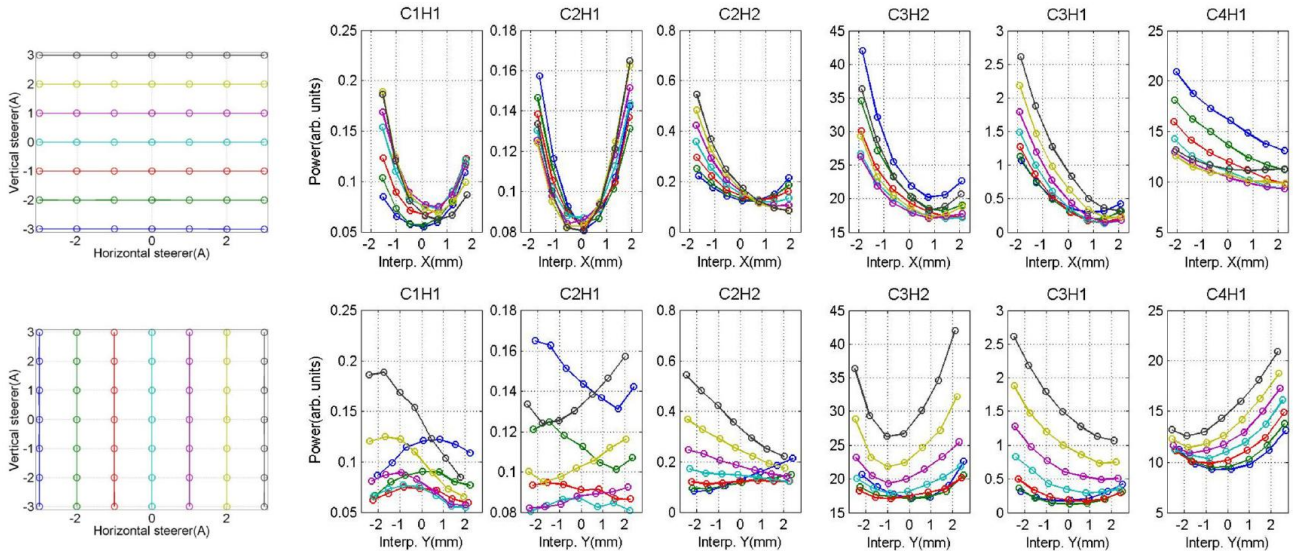

Figure 4.18: Integrated power as a function of transverse position interpolated in each cavity. The center frequency is 9066 MHz with a 20 MHz BPF.

4.5 Estimation of the Resolution

Fundamentally the measurement resolution is limited by the thermal noise, which is unavoidable at non-zero temperature. The smallest measurable thermal energy, U_{th} , is [33]

$$U_{th} = \frac{1}{2}k_B T, \quad (4.1)$$

where T is the temperature in K and k_B is the Boltzmann constant ($8.6 \times 10^{-5} \text{ eV} \cdot K^{-1}$). Assuming a room temperature of 300 K , $U_{th} = 0.0129 \text{ eV}$.

A beam with charge q traversing a cavity loses an energy U in a particular mode as [34]

$$U = \frac{\omega}{2} \cdot \left(\frac{R}{Q}\right) \cdot q^2, \quad (4.2)$$

where R/Q (the shunt impedance divided by the quality factor) has the unit of Ω/cm^{-2} , ω is the angular frequency of the mode. This energy radiates to the HOM coupler.

For the third harmonic 3.9 GHz cavity, the strongest coupling mode in the second dipole band has a frequency of 5.4427 GHz and a R/Q value of $20.877 \text{ } \Omega/cm^{-2}$ [14], and its energy deposited by a 1 nC beam is

$$U[eV/cm^2] = \frac{2\pi \cdot 5.4427GHz}{2} \cdot 20.877\Omega/cm^{-2} \cdot (1nC)^2 \cdot 6.2 \times 10^{18} = 2.2 \times 10^{12} eV/cm^2. \quad (4.3)$$

This corresponds to a transverse beam offset

$$r = \sqrt{\frac{U_{th}}{U}} = 0.8 \text{ nm}. \quad (4.4)$$

The HOM signals are brought from the coupler inside FLASH tunnel to the HOM patch panel outside the tunnel by long cables. The measured cable loss is approximately 20 dB , the electronics attenuation is 26 dB (10 dB in the RF section and 16 dB in the IF section), this degrades the resolution by a factor of f_{cable} as

$$r^* = f_{cable} \cdot r = 10^{\frac{20dB+26dB}{20}} \cdot r = 199.5 \times 0.8nm = 160 \text{ nm}. \quad (4.5)$$

The theoretical minimum resolution is therefore 160 nm , as compared to the observed resolution of $20\text{-}50 \text{ } \mu m$ (see Fig. 4.10(a)). This discrepancy may come from three main aspects.

First, HOM signals are all normalized to bunch charge before the position prediction. The bunch charge was recorded from the nearby toroid, which has a measured resolution of 3 pC . The measured bunch charge was $\sim 0.5 \text{ nC}$ throughout our studies presented in this report, therefore it corresponds to a relative resolution of $\sim 6\%$. At 1 mm beam offset, this contributes $\sim 6 \text{ } \mu m$ to the position resolution.

Second, readouts of two BPMs are used to interpolate the beam position into the cavity/module and then to calibrate the HOM signals. These two BPMs have a measured resolution of $\sim 20 \text{ } \mu m$, contributing to the resolution of the HOM-based system.

Third, the phase noise of the LO used to down-mix the HOM signal can also contribute to the resolution. This need to be studied in future measurements.

Therefore, it can be seen that the measured position resolution is dominated by the BPM resolution used for position interpolation. For the measurement of local position inside each cavity, BPMs can be used to calibrate HOM signals in C1 and C3, the position measured in these two cavities can then be used to make a prediction about the position in C2. In this case, the limitations of BPMs are eliminated from the position prediction in C2, and will consequently improve the resolution.

Chapter 5

Summary

We have studied three modal options with the specially designed test electronics for the third harmonic 3.9 GHz cavities at FLASH. Localized modes are used to determine the individual beam position in each cavity, and the resolution is approximately 50–100 μm . The transverse beam position at the center of the ACC39 module can be determined by using the coupled modes, and the resolution is approximately 20–50 μm due to the strong coupling of these modes to the beam. The resolution estimation with the test electronics for all modal options is shown in Table 5.1. Based on these results we decided to build HOM electronics for the second dipole band and the fifth dipole band, so that we will have both high resolution measurements for the whole module, and localized measurements for individual cavity. A prototype HOM electronics is being built by Fermilab and planned to be tested in FLASH by the end of 2012.

Table 5.1: Resolution estimation for various modal options with the test electronics.

	Localized Modes		Coupled Modes	
	Beam-pipe modes	5 th dipole band	1 st dipole band	2 nd dipole band
x (μm)	40–100	40–60	20–30	20–30
y (μm)	80–180	50–100	30–70	20–50

Acknowledgements

We thank Dr. Jacek Sekutowicz for carefully reading this manuscript and many useful comments. This work received support from the European Commission under the FP7 Research Infrastructures grant agreement No.227579.

Bibliography

- [1] W. Ackermann *et al.*, “Operation of a free-electron laser from the extreme ultraviolet to the water window,” *Nature Photonics*, vol. 1, pp. 336–342, 2007.
- [2] J. Sekutowicz, *Multi-cell Superconducting Structures for High Energy $e+e-$ Colliders and Free Electron Laser Linacs*. Warsaw, Poland: Warsaw University of Technology Publishing House, first ed., 2008.
- [3] K. Floettmann, T. Limberg and Ph. Piot, “Generation of Ultrashort Electron Bunches by Cancellation of Nonlinear Distortions in the Longitudinal Phase Space,” TESLA-FEL Report: TESLA-FEL 2001-06, 2001.
- [4] J. Sekutowicz, R. Wanzenberg, W.F.O. Mueller and T. Weiland, “A Design of a 3rd Harmonic Cavity for the TTF 2 Photoinjector,” TESLA-FEL Report: TESLA-FEL 2002-05, 2002.
- [5] K.L.F. Bane, “Wake Field Effects in a Linear Collider,” SLAC Note: SLAC-PUB-4169, 1986.
- [6] S. Molloy *et al.*, “High precision superconducting cavity diagnostics with higher order mode measurements,” *Phys. Rev. ST Accel. Beams*, vol. 9, p. 112801, 2006.
- [7] G. Devanz *et al.*, “HOM Beam Coupling Measurements at the TESLA Test Facility (TTF),” in *Proceedings of EPAC2002*, (Paris, France), pp. 230–232, 2002.
- [8] N. Baboi *et al.*, “Preliminary Study on HOM-Based Beam Alignment in the TESLA Test Facility,” in *Proceedings of LINAC 2004*, (Lübeck, France), pp. 117–119, 2004.
- [9] MAFIA Release 4. CST AG, Darmstadt, Germany.
- [10] T. Khabibouline *et al.*, “Higher Order Modes of a 3rd Harmonic Cavity with an Increased End-cup Iris,” TESLA-FEL Report: TESLA-FEL 2003-01, 2003.
- [11] ANSYS®HFSS. Release 11.2, ANSYS Inc., USA.
- [12] I.R.R. Shinton *et al.*, “Compendium of Eigenmodes in Third Harmonic Cavities for FLASH and the XFEL,” DESY Report: DESY 12-053, 2012.
- [13] CST Microwave Studio®. Ver. 2011, CST AG, Darmstadt, Germany.
- [14] P. Zhang, N. Baboi and R.M. Jones, “Eigenmode simulations of third harmonic superconducting accelerating cavities for FLASH and the European XFEL,” DESY Report: DESY 12-101, 2012.
- [15] I.R.R. Shinton *et al.*, “Higher Order Modes in Third Harmonic Cavities for XFEL/FLASH,” in *Proceedings of IPAC’10*, (Kyoto, Japan), pp. 3007–3009, 2010.
- [16] I.R.R. Shinton *et al.*, “Higher Order Modes in Third Harmonic Cavities at FLASH,” in *Proceedings of Linear Accelerator Conference LINAC2010*, (Tsukuba, Japan), pp. 785–787, 2010.
- [17] T. Flisgen *et al.*, “A Concatenation Scheme for the Computation of Beam Excited Higher Order Mode Port Signals,” in *Proceedings of IPAC2011*, (San Sebastian, Spain), pp. 2238–2240, 2011.
- [18] I.R.R. Shinton *et al.*, “Higher Order Modes in Coupled Cavities of the FLASH Module ACC39,” in *Proceedings of IPAC2011*, (San Sebastian, Spain), pp. 2301–2303, 2011.

- [19] I.R.R. Shinton *et al.*, “Simulations of higher order modes in the ACC39 module of FLASH,” in *IPAC2012*, (New Orleans, USA,), 2012. TUPPR037.
- [20] P. Zhang, N. Baboi and R.M. Jones, “Higher order mode spectra and the dependence of localized dipole modes on the transverse beam position in third harmonic superconducting cavities at FLASH,” DESY Report: DESY 12-109, 2012.
- [21] P. Zhang *et al.*, “First Beam Spectra of SC Third Harmonic Cavity at FLASH,” in *Proceedings of Linear Accelerator Conference LINAC2010*, (Tsukuba, Japan), pp. 782–784, 2010.
- [22] P. Zhang *et al.*, “Beam-based HOM Study in Third Harmonic SC Cavities for Beam Alignment at FLASH,” in *Proceedings of DIPAC2011*, (Hamburg, Germany), pp. 77–79, 2011.
- [23] H.-W. Glock *et al.*, “Diode Down-mixing of HOM Coupler Signals for Beam Position Determination in 1.3-GHz- and 3.9-GHz-Cavities at FLASH,” in *Proceedings of DIPAC2011*, (Hamburg, Germany), pp. 101–103, 2011.
- [24] P. Zhang *et al.*, “Study of Beam Diagnostics with Trapped Modes in Third Harmonic Superconducting Cavities at FLASH,” in *Proceedings of IPAC2011*, (San Sebastian, Spain), pp. 2891–2893, 2011.
- [25] N. Baboi *et al.*, “Higher Order Modes for Beam Diagnostics in Third Harmonic 3.9 GHz Accelerating Modules,” in *Proceedings of SRF2011*, (Chicago, USA), pp. 239–243, 2011.
- [26] R.S. Larsen, “PICMG xTCA Standards Extensions for Physics: New Developments and Future Plans,” SLAC Note: SLAC-PUB-14182, 2010.
- [27] EPICS. <http://www.aps.anl.gov/epics/>.
- [28] DOOCS. <http://tesla.desy.de/doocs/>.
- [29] MATLAB®. Ver. R2011b, The MathWorks Inc., USA.
- [30] R.L. Ott and M. Longnecker, *An Introduction to Statistical Methods and Data Analysis*, ch. 11.7, p. 611. Duxbury Press, sixth ed., 2008.
- [31] G.H. Golub and C.F. Van Loan, *Matrix Computations*, ch. 2.3, pp. 16–20. The John Hopkins University Press, second ed., 1984.
- [32] R. Kohavi, “A Study of Cross-Validation and Bootstrap for Accuracy Estimation and Model Selection,” in *Proceedings of the 14th International Joint Conference on Artificial Intelligence*, vol. 2, (Montreal, Quebec, Canada), pp. 1137–1143, 1995.
- [33] W.B. Davenport and W.L. Root, *An introduction to the theory of random signals and noise*, ch. 9-4, p. 185. IEEE Press, 1987.
- [34] A. Chao and M. Tigner, *Handbook of Accelerator Physics and Engineering*, ch. 3.2.7, p. 213. Singapore: World Scientific, first ed., 1999.

Appendix A

The Analog Box Circuit

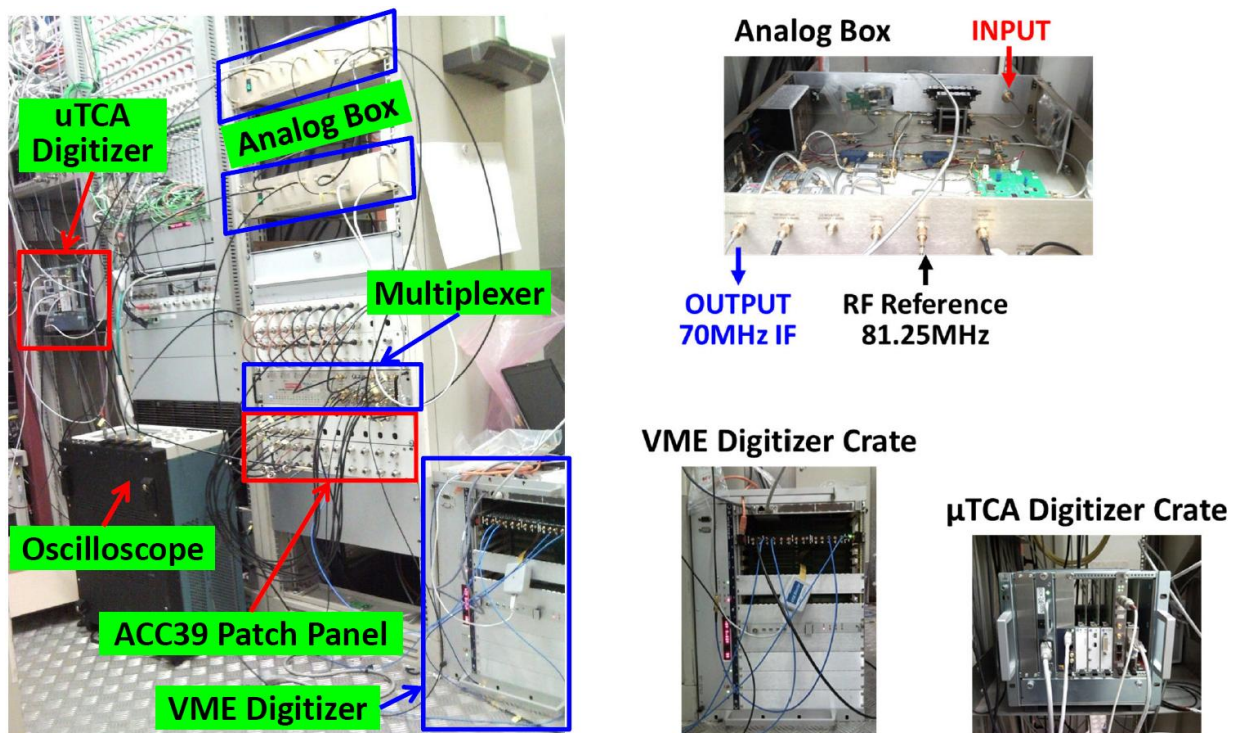

Figure A.1: Photo of the device setup in the FLASH injector barrack outside the tunnel, the analog box and two types of digitizer.

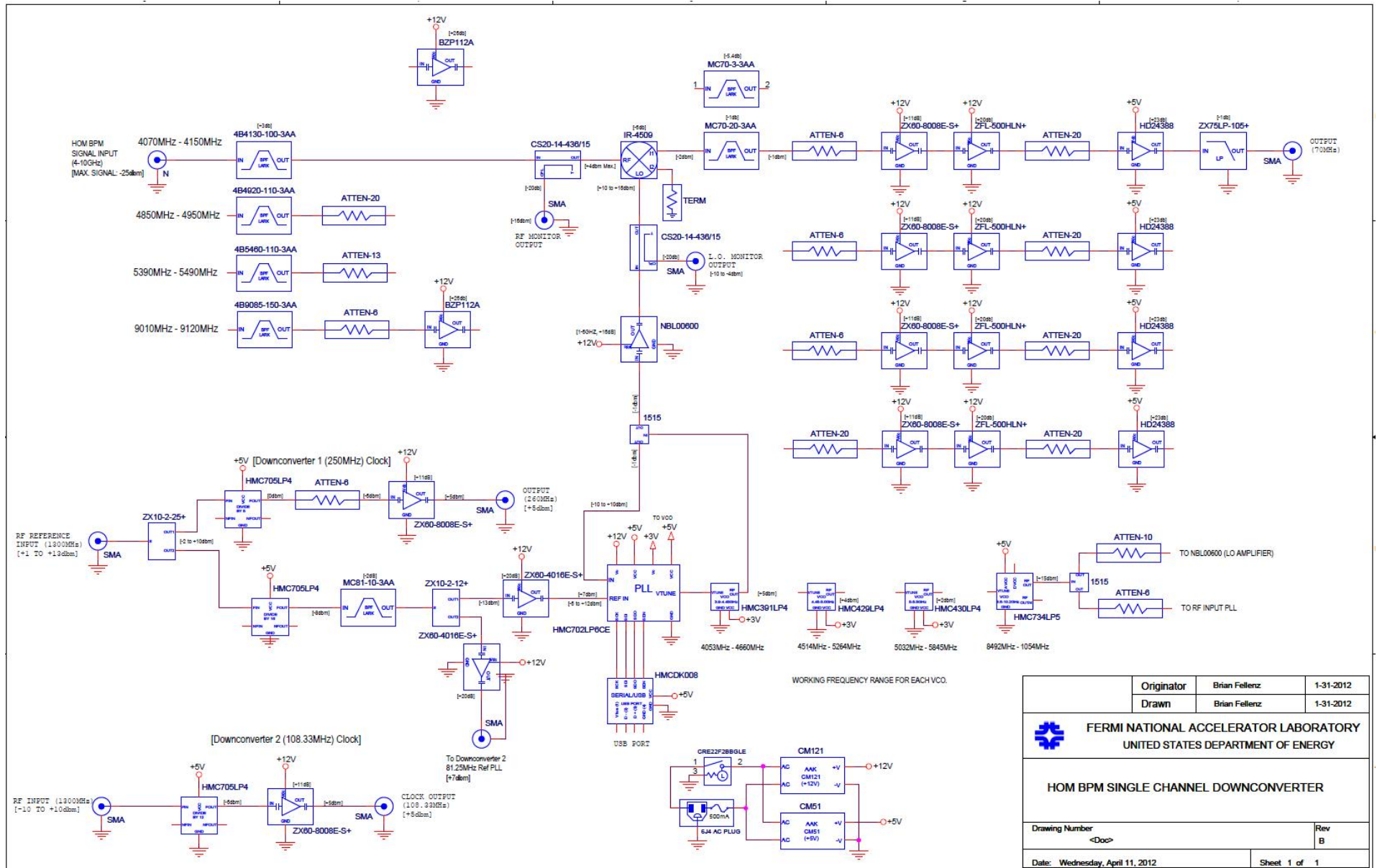

Figure A.2: Drawing of the analog box.

Appendix B

Settings in the Analog Box

HOM signals vary amongst couplers and frequency bands. Therefore various amplification and attenuations were used for each frequency band. They are listed in Table B.1.

Table B.1: Settings in the analog box for each frequency band. “+” means amplification and “−” means attenuation.

Band	Center frequency	Bandwidth	RF section	IF section	Total
Beam-pipe modes	4082 MHz	20 MHz	+0 dB	+33 dB	+33 dB
	4118 MHz	20 MHz			
1 st dipole band	4859 MHz	20 MHz	−13 dB	+32 dB	+19 dB
	4904 MHz	20 MHz			
	4940 MHz	20 MHz			
	4900 MHz	100 MHz			
2 nd dipole band	5437 MHz	20 MHz	−10 dB	+36 dB	+26 dB
	5464 MHz	20 MHz			
	5482 MHz	20 MHz			
	5450 MHz	100 MHz			
5 th dipole band	9048 MHz	20 MHz	−6 dB	+52 dB	+46 dB
	9066 MHz	20 MHz			

Appendix C

Tables: Position Resolutions

Resolutions in predicting beam positions for validation samples are listed in this appendix. The method applied is *singular value decomposition* (SVD). The number of SVD modes used for regression is determined based on a stable and good position resolution. These are listed in Appendix D. Both the fixed sample split and a *leave-one-out cross-validation* (LOOCV) are shown. The reading jumps of the BPM-A readouts have been corrected in y plane for all modal options.

C.1 The Localized Beam-pipe modes

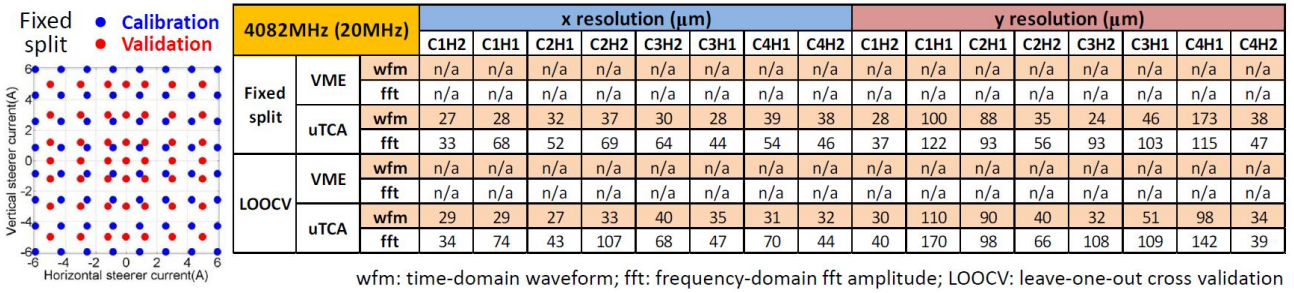

Figure C.1: Position resolutions of beam-pipe modes centered at 4082 MHz with a 20 MHz bandwidth.

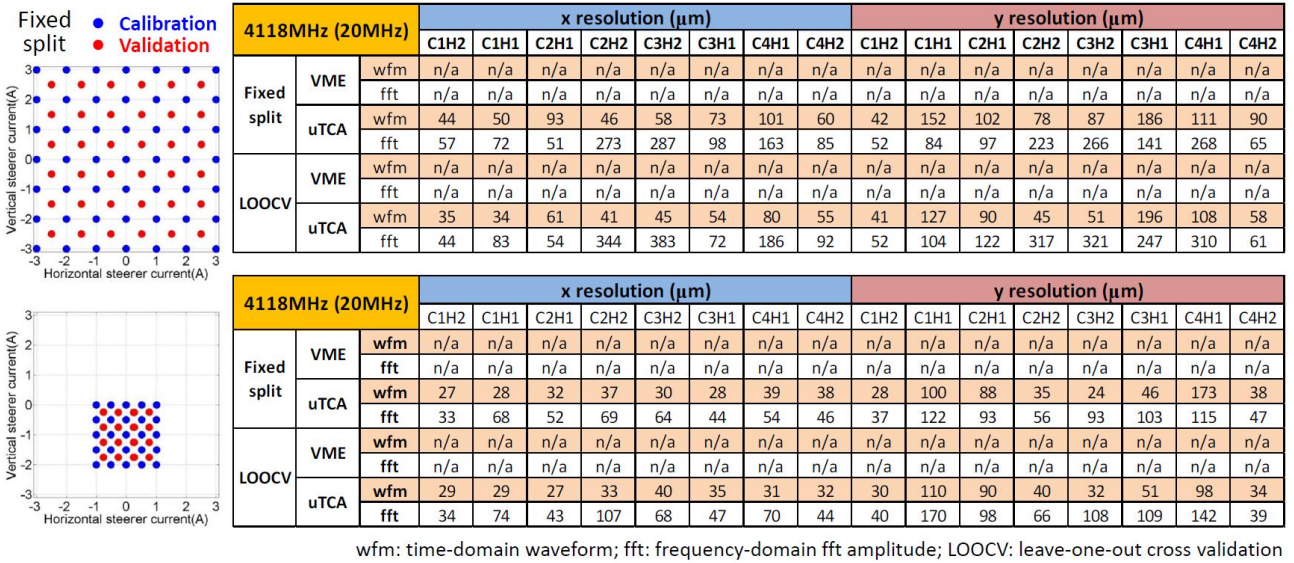

Figure C.2: Position resolutions of beam-pipe modes centered at 4118 MHz with a 20 MHz bandwidth.

C.2 Coupled Cavity Modes - The First Dipole Band

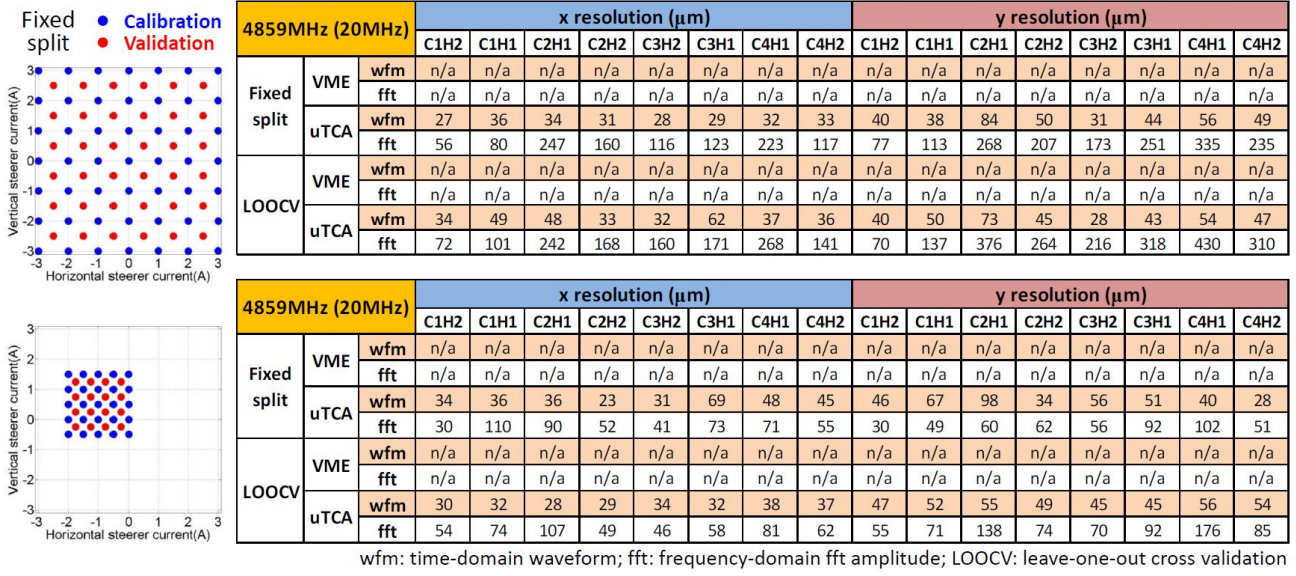

Figure C.3: Position resolutions of cavity modes centered at 4859 MHz with a 20 MHz bandwidth.

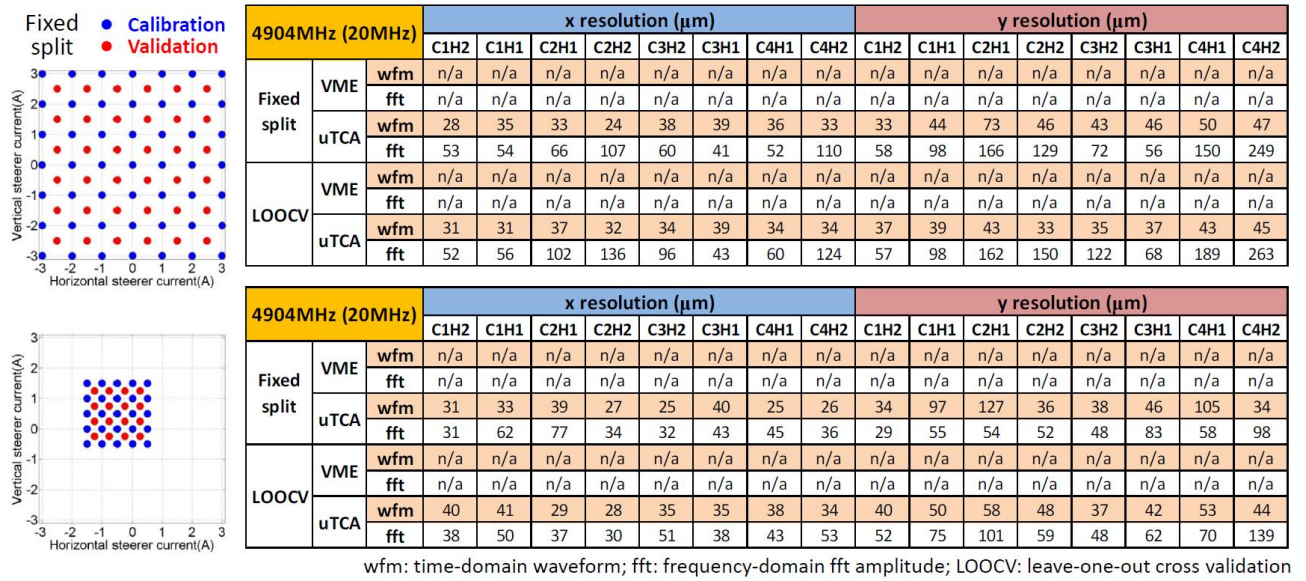

Figure C.4: Position resolutions of cavity modes centered at 4904 MHz with a 20 MHz bandwidth.

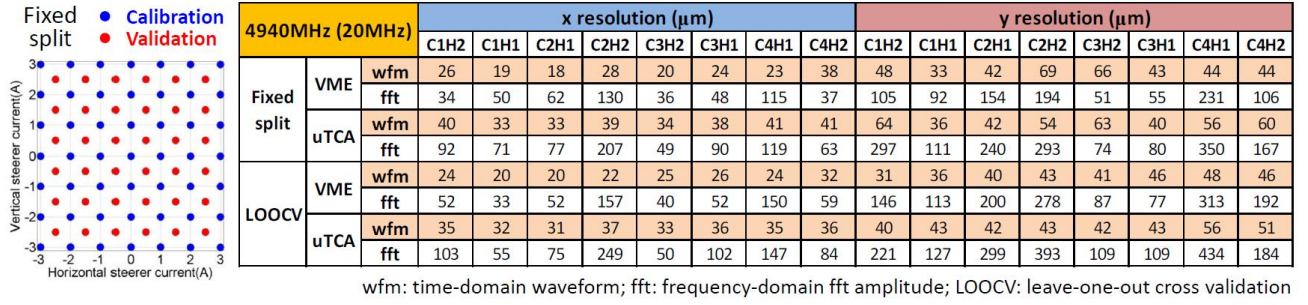

Figure C.5: Position resolutions of cavity modes centered at 4940 MHz with a 20 MHz bandwidth.

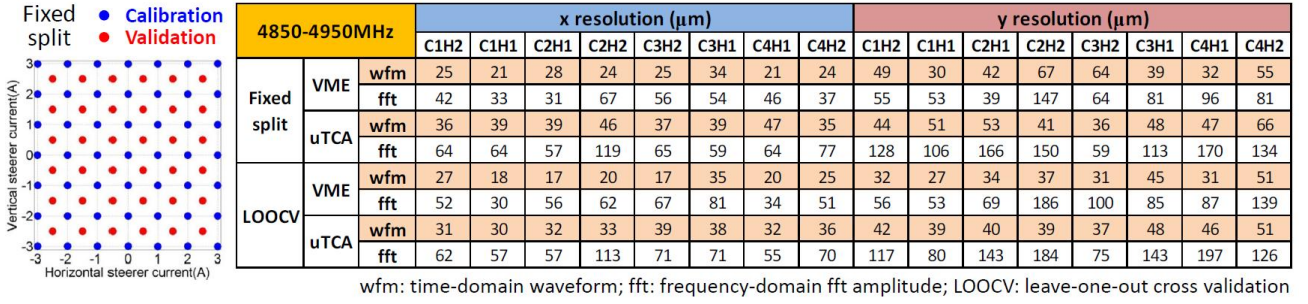

Figure C.6: Position resolutions of cavity modes from 4850 MHz to 4950 MHz.

C.3 Coupled Cavity Modes - The Second Dipole Band

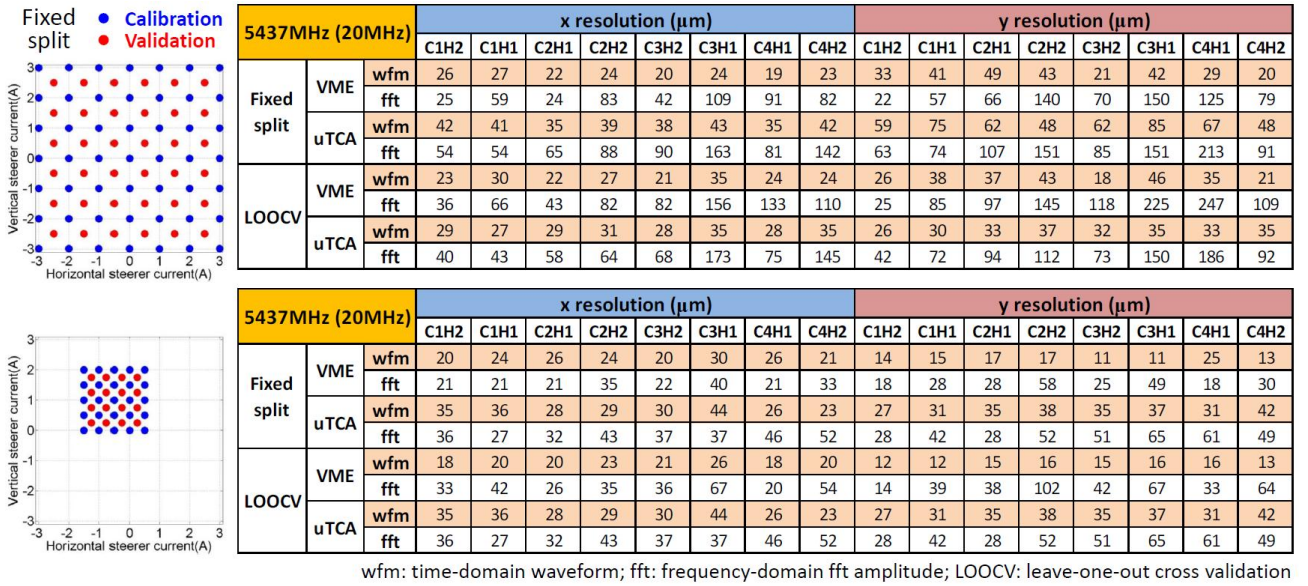

Figure C.7: Position resolutions of cavity modes centered at 5437 MHz with a 20 MHz bandwidth.

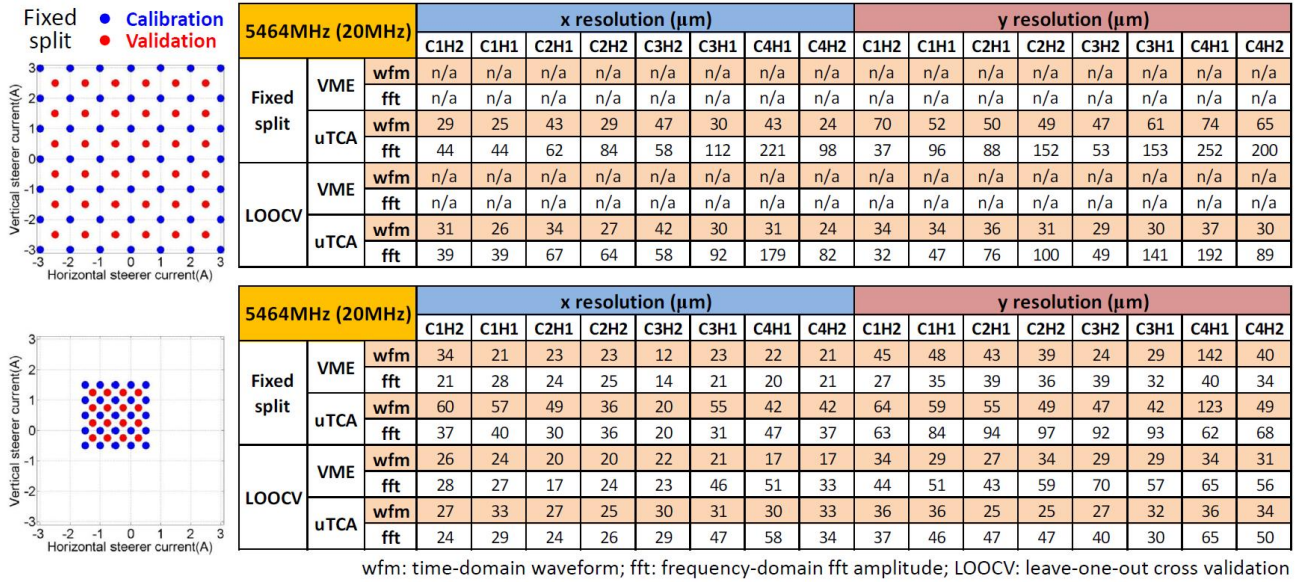

Figure C.8: Position resolutions of cavity modes centered at 5464 MHz with a 20 MHz bandwidth.

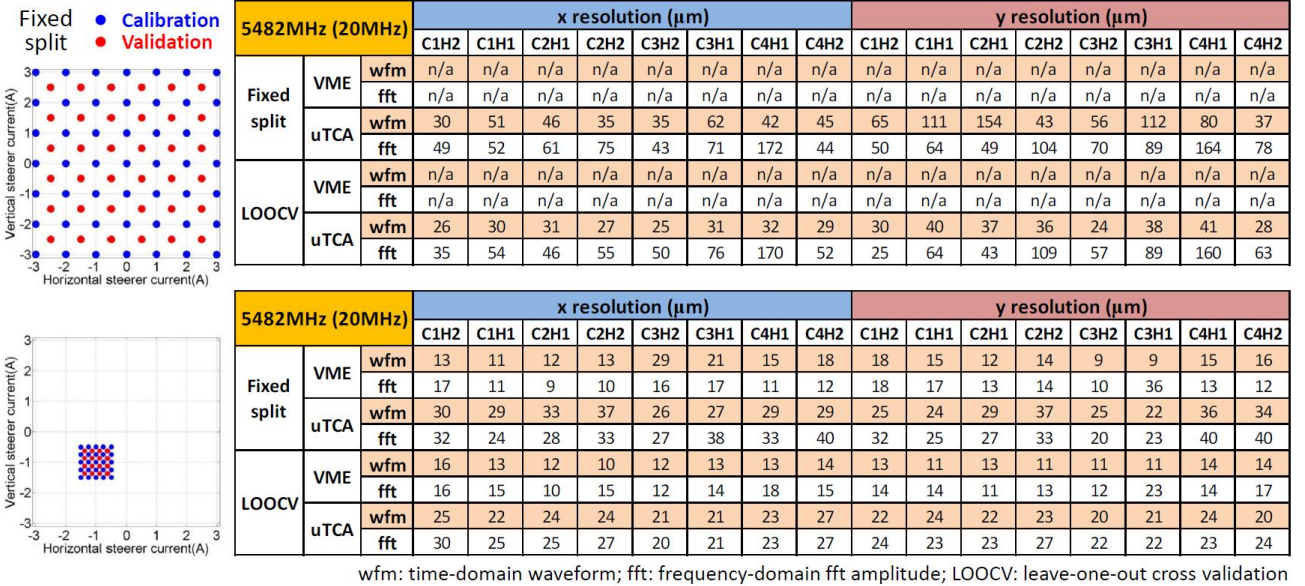

Figure C.9: Position resolutions of cavity modes centered at 5482 MHz with a 20 MHz bandwidth.

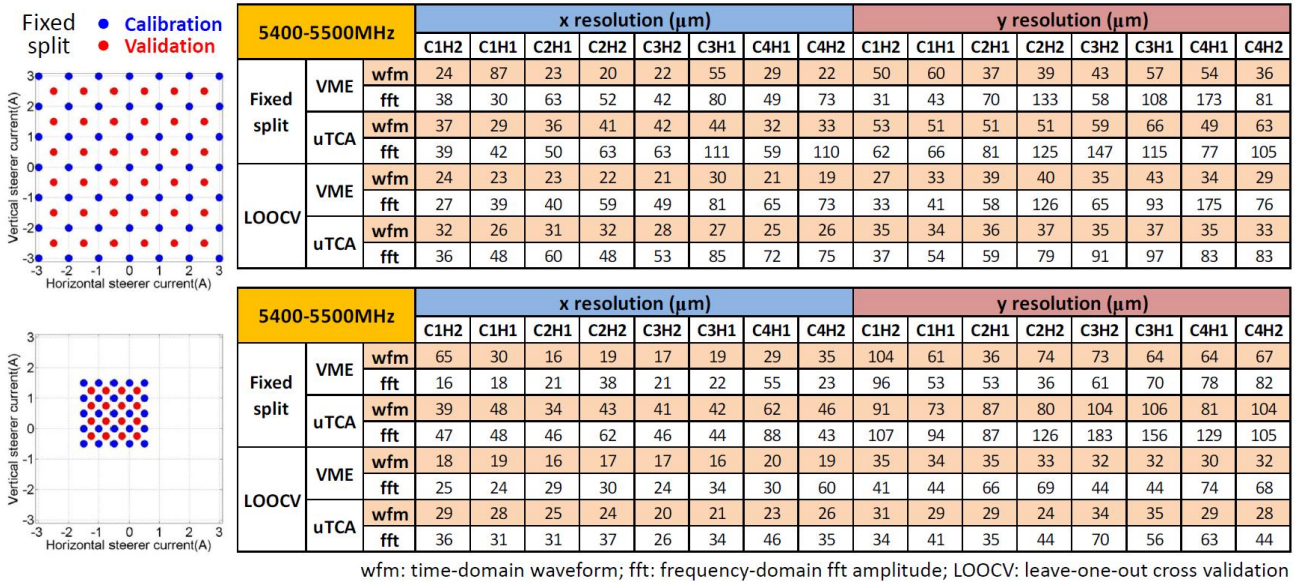

Figure C.10: Position resolutions of cavity modes from 5400 MHz to 5500 MHz.

C.4 Trapped Cavity Modes - The Fifth Dipole Band

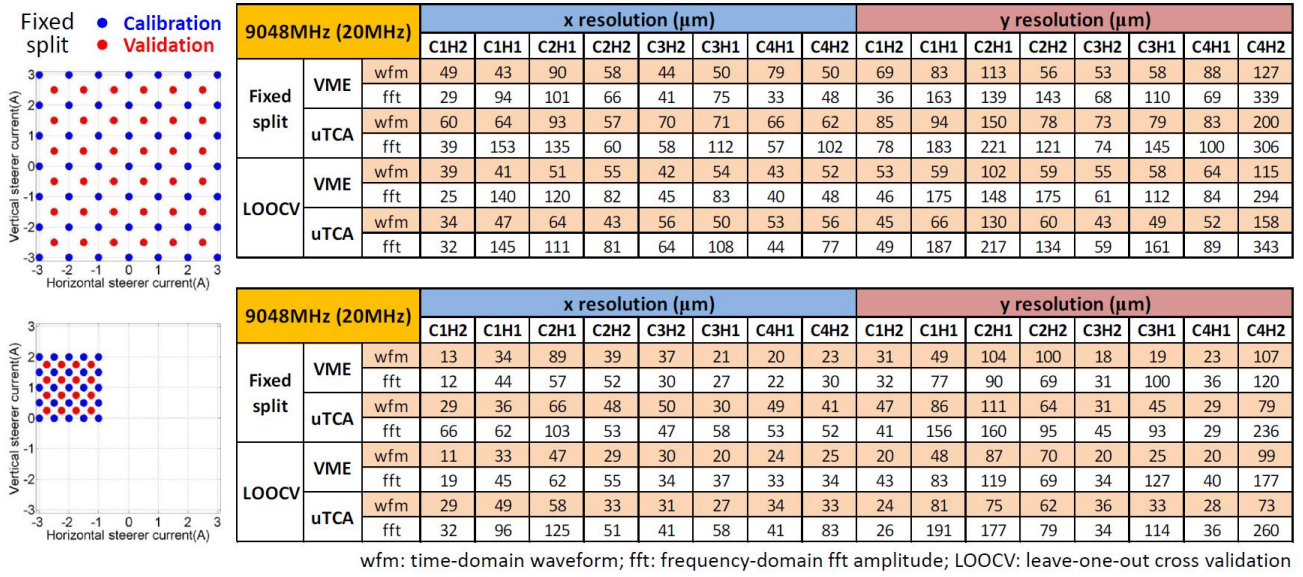

Figure C.11: Position resolutions of cavity modes centered at 9048 MHz with a 20 MHz bandwidth.

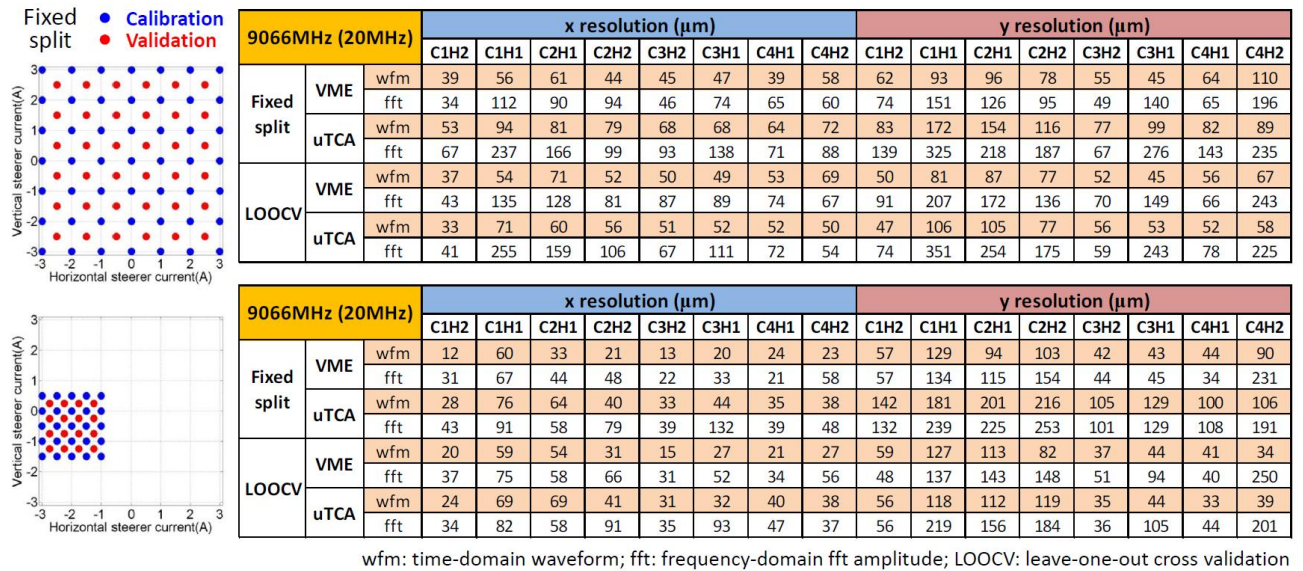

Figure C.12: Position resolutions of cavity modes centered at 9066 MHz with a 20 MHz bandwidth.

Appendix D

Tables: Number of SVD Modes

This appendix shows the number of SVD modes used in position determination shown in Appendix C. The number of SVD modes used for regression is determined based on a stable and good position resolution.

D.1 The Localized Beam-pipe modes

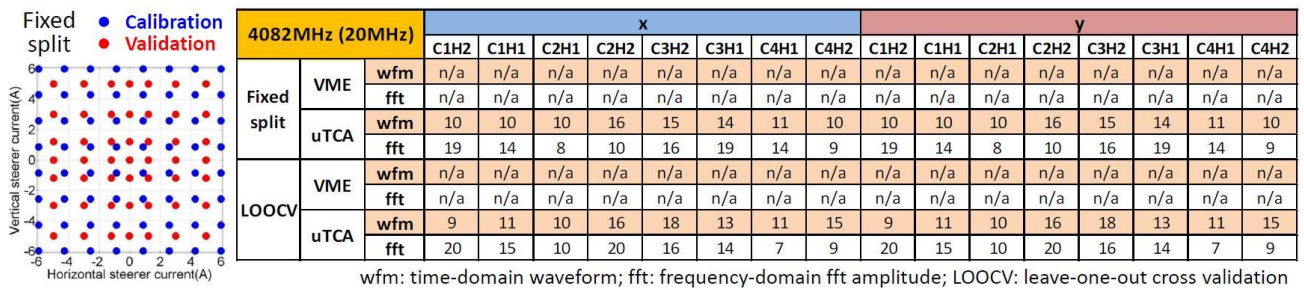

Figure D.1: Number of SVD modes used for position determination of beam-pipe modes centered at 4082 MHz with a 20 MHz bandwidth.

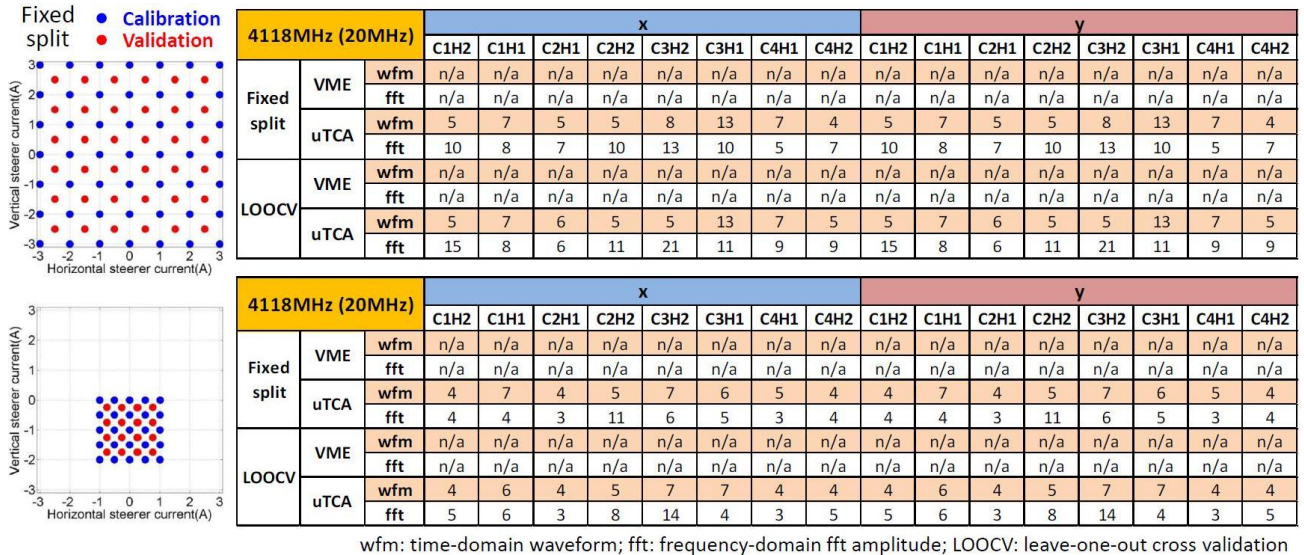

Figure D.2: Number of SVD modes used for position determination of beam-pipe modes centered at 4118 MHz with a 20 MHz bandwidth.

D.2 Coupled Cavity Modes - The First Dipole Band

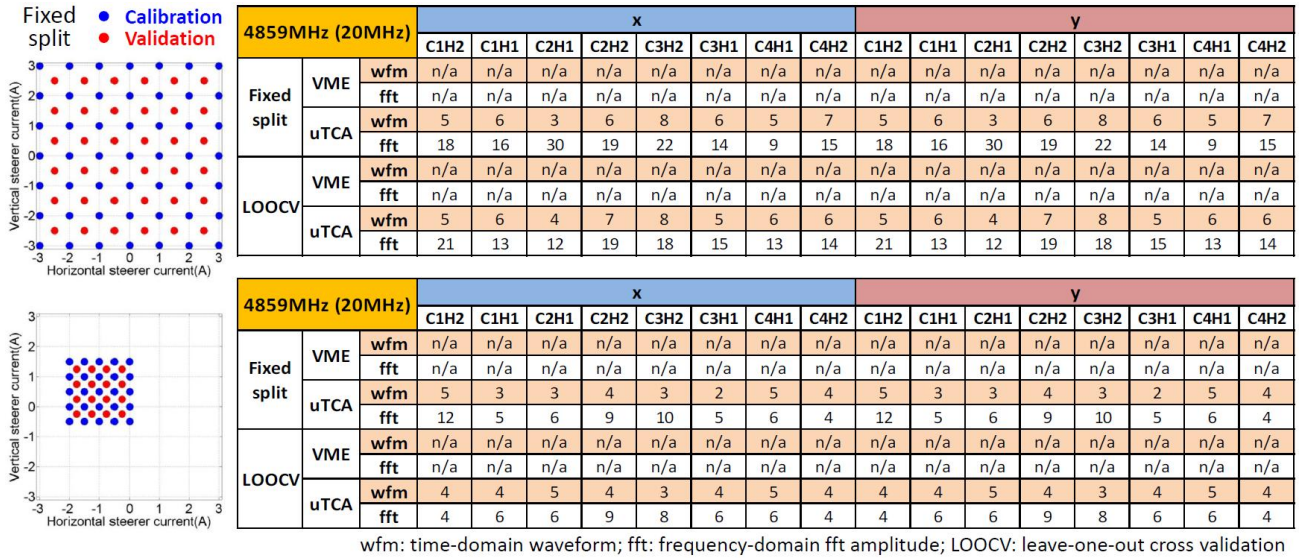

Figure D.3: Number of SVD modes used for position determination of cavity modes centered at 4859 MHz with a 20 MHz bandwidth.

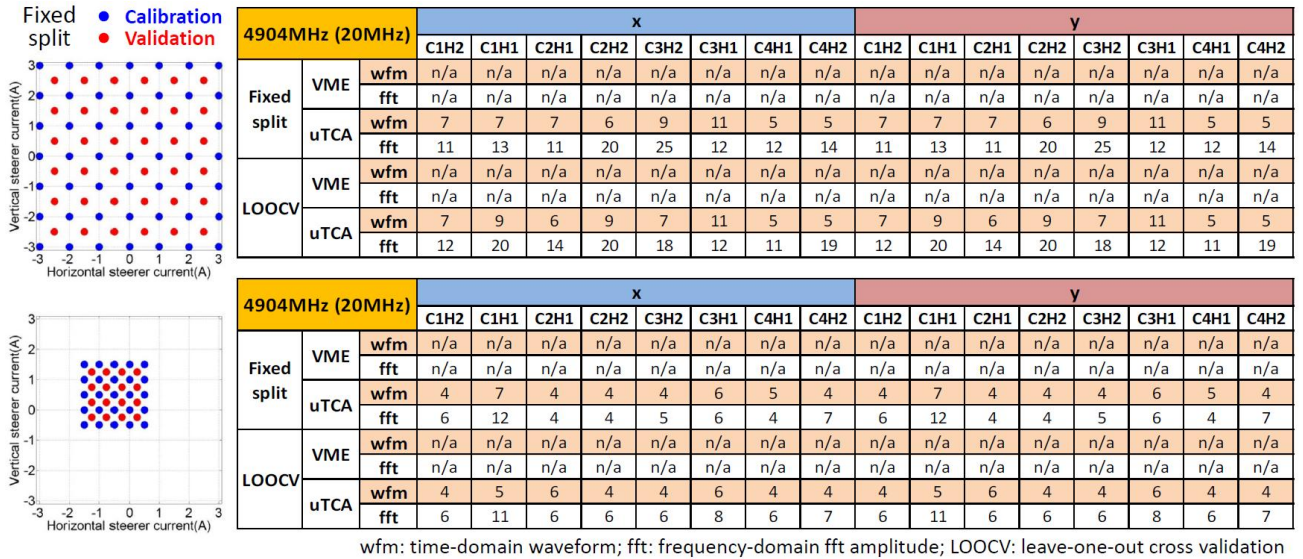

Figure D.4: Number of SVD modes used for position determination of cavity modes centered at 4904 MHz with a 20 MHz bandwidth.

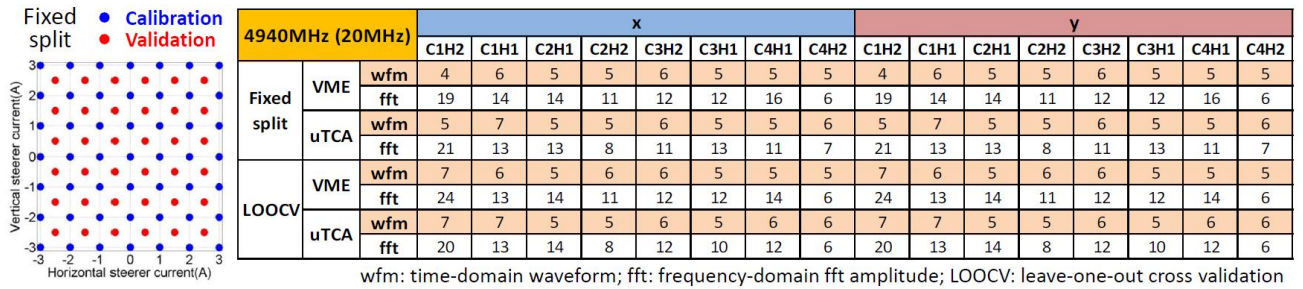

Figure D.5: Number of SVD modes used for position determination of cavity modes centered at 4940 MHz with a 20 MHz bandwidth.

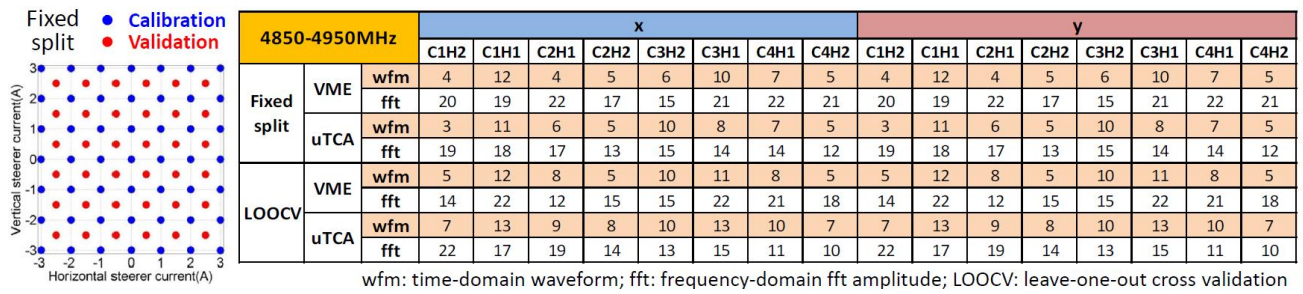

Figure D.6: Number of SVD modes used for position determination of cavity modes from 4850 MHz to 4950 MHz.

D.3 Coupled Cavity Modes - The Second Dipole Band

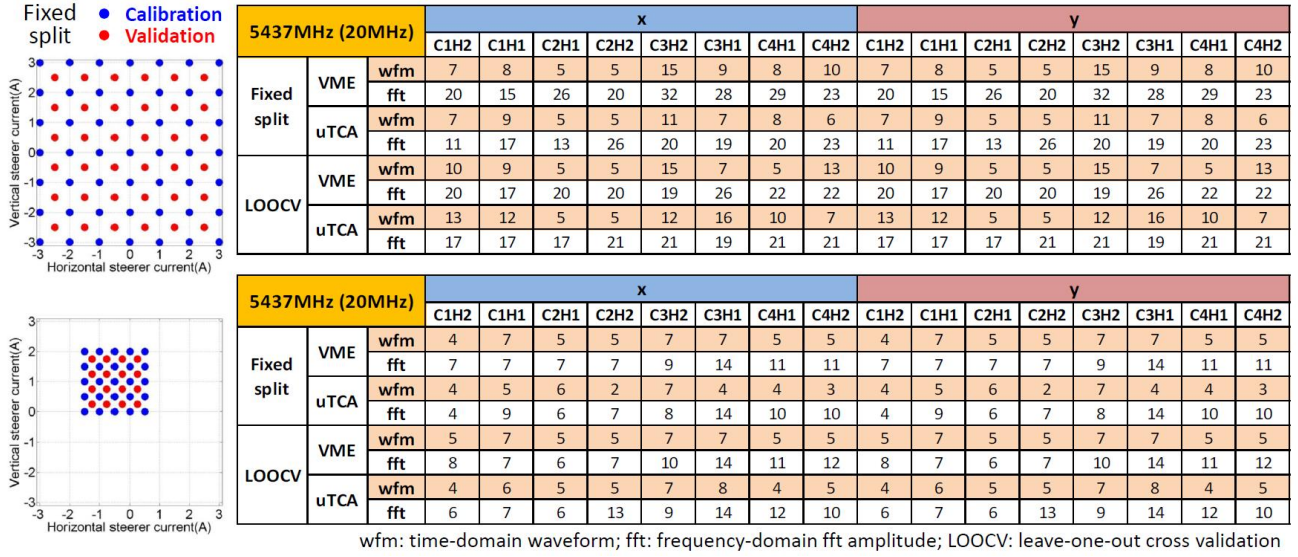

Figure D.7: Number of SVD modes used for position determination of cavity modes centered at 5437 MHz with a 20 MHz bandwidth.

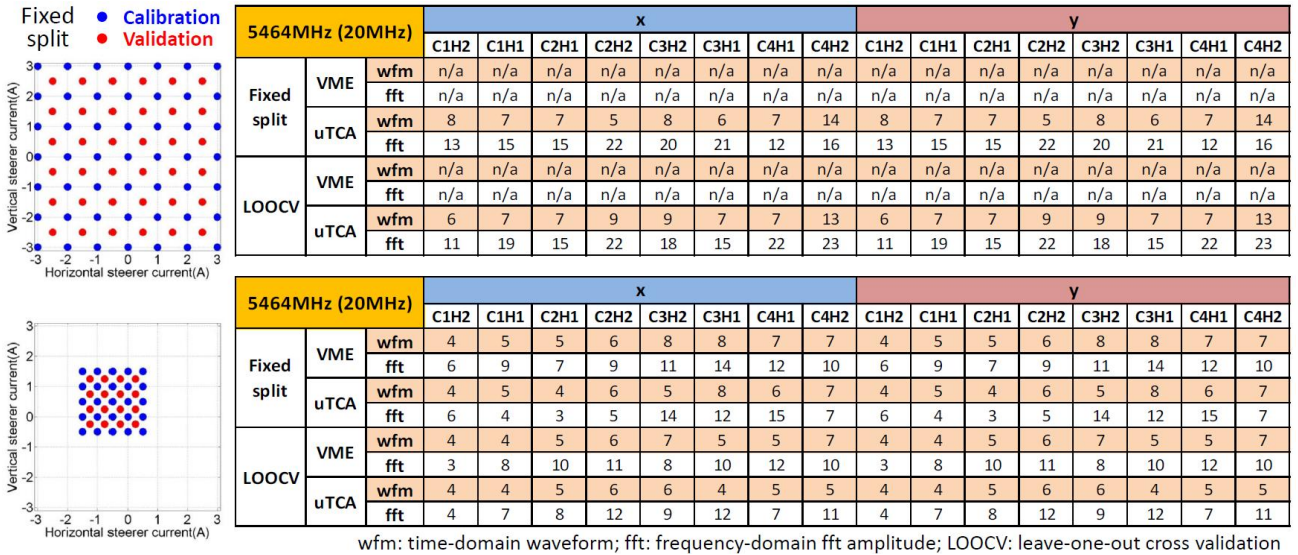

Figure D.8: Number of SVD modes used for position determination of cavity modes centered at 5464 MHz with a 20 MHz bandwidth.

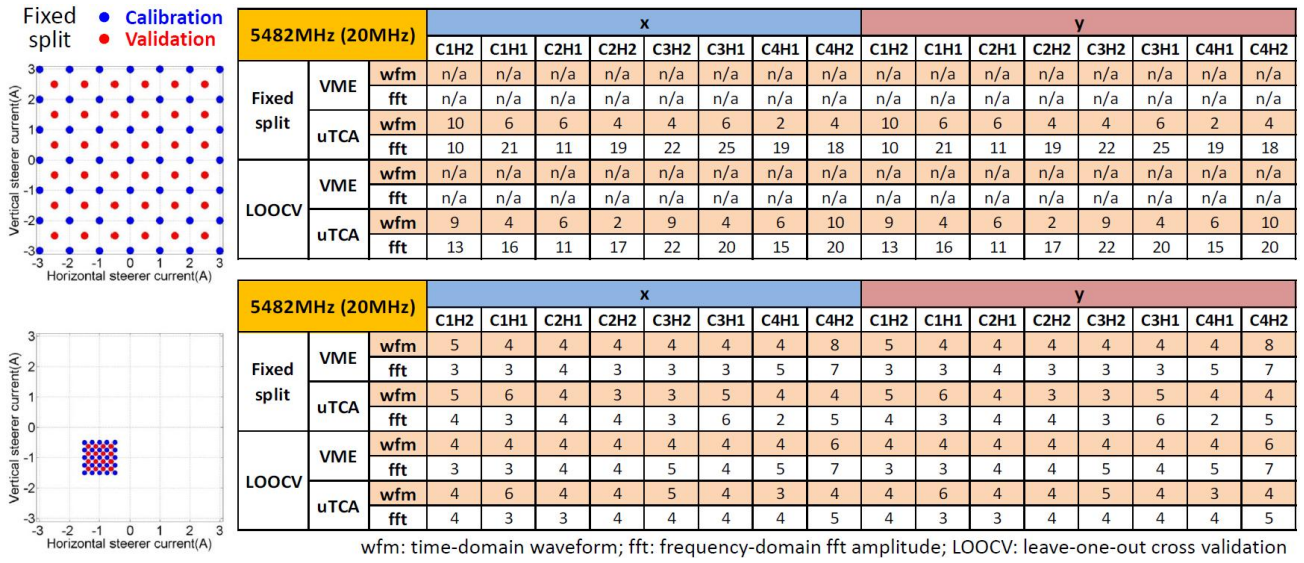

Figure D.9: Number of SVD modes used for position determination of cavity modes centered at 5482 MHz with a 20 MHz bandwidth.

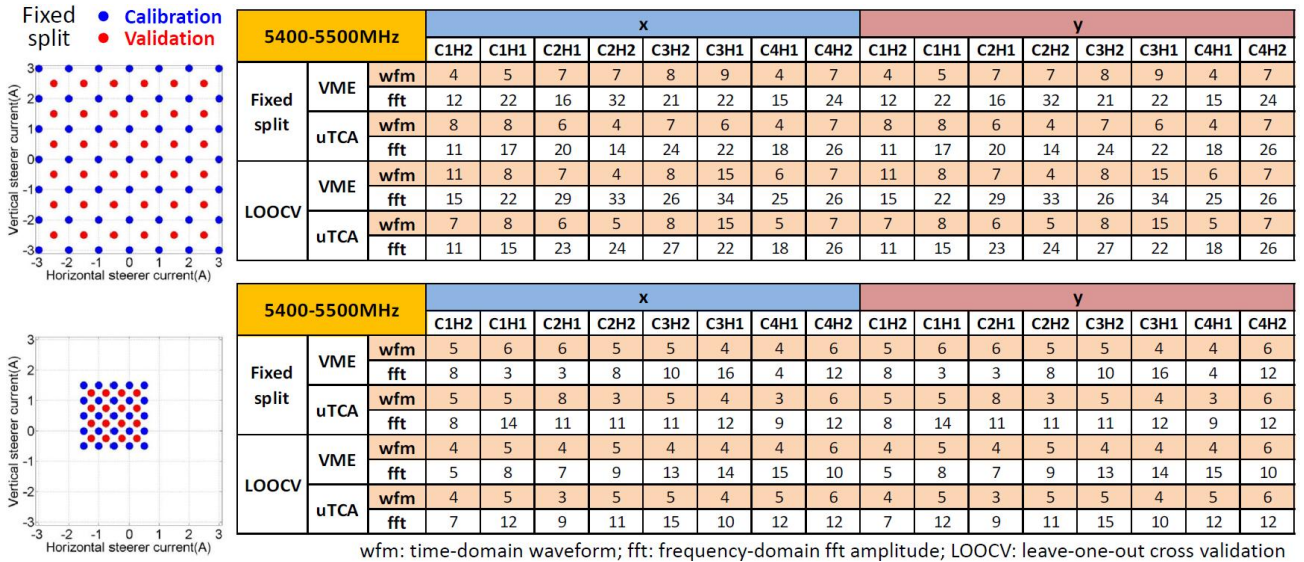

Figure D.10: Number of SVD modes used for position determination of cavity modes from 5400 MHz to 5500 MHz.

D.4 Trapped Cavity Modes - The Fifth Dipole Band

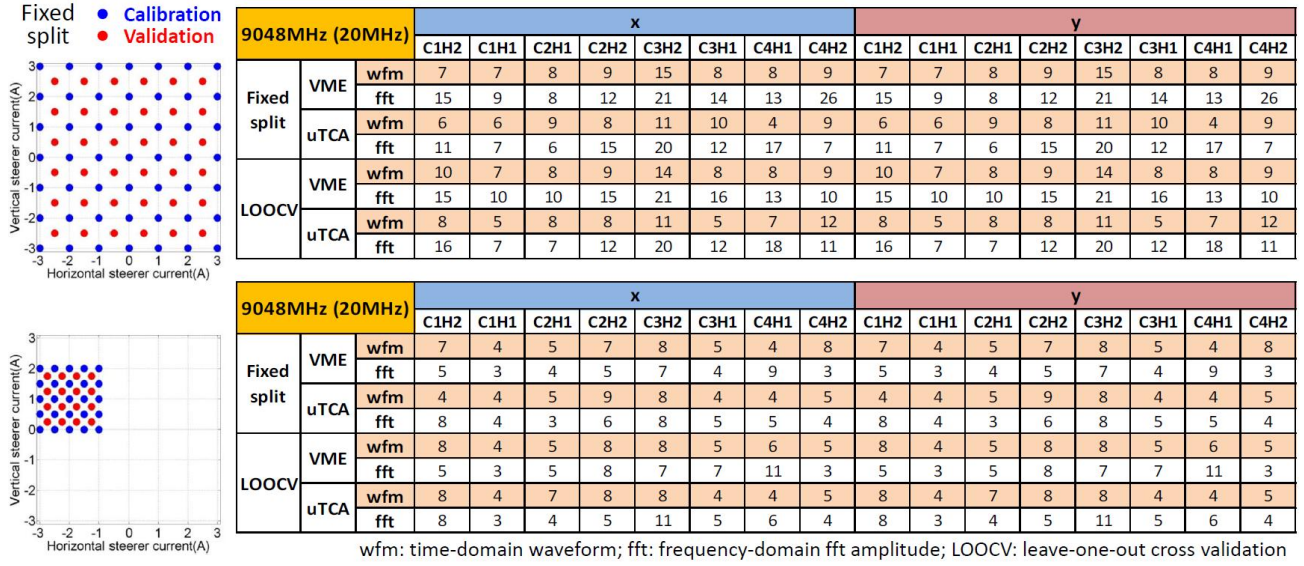

Figure D.11: Number of SVD modes used for position determination of cavity modes centered at 9048 MHz with a 20 MHz bandwidth.

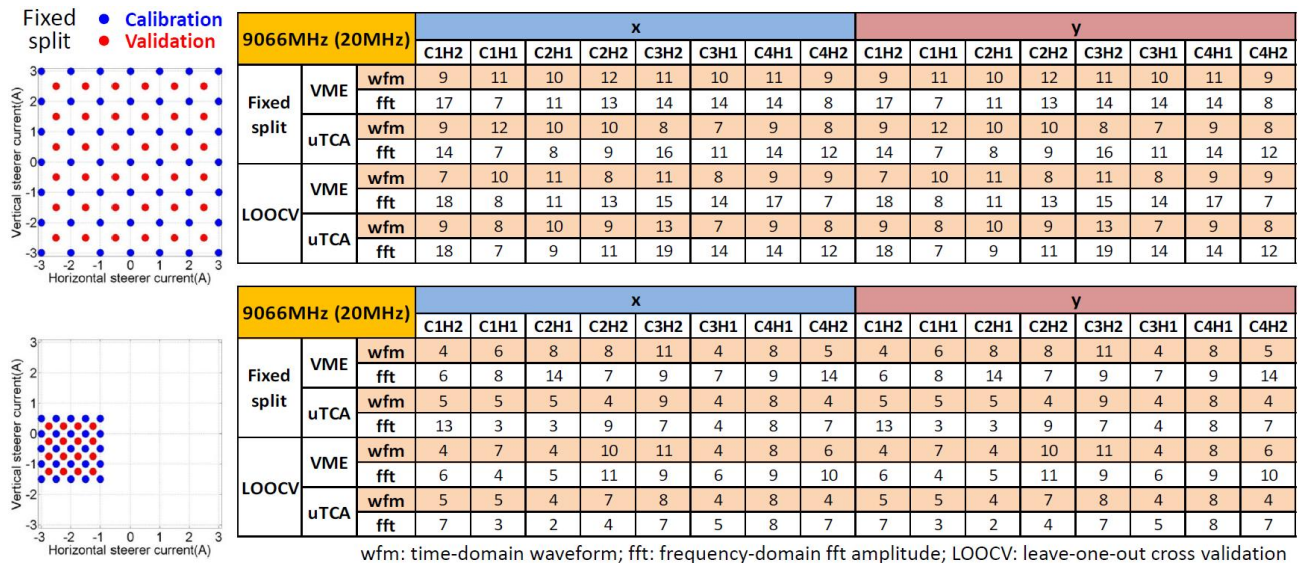

Figure D.12: Number of SVD modes used for position determination of cavity modes centered at 9066 MHz with a 20 MHz bandwidth.