

Lepton Number and Lepton Flavor Violation Through Color Octet States

Sandhya Choubey,^{a,*} Michael Duerr,^{b,†} Manimala Mitra,^{c,‡} Werner Rodejohann^{b,§}

^a*Harish-Chandra Research Institute, Chhatnag Road, Jhansi, 211019 Allahabad, India*

^b*Max-Planck-Institut für Kernphysik, Postfach 103980, 69029 Heidelberg, Germany*

^c*I.N.F.N., Laboratori Nazionali del Gran Sasso, 67010 Assergi (AQ), L'Aquila, Italy*

Abstract

We discuss neutrinoless double beta decay and lepton flavor violating decays such as $\mu \rightarrow e\gamma$ in the colored seesaw scenario. In this mechanism, neutrino masses are generated at one-loop via the exchange of TeV-scale fermionic and scalar color octets. The same particles mediate lepton number and flavor violating processes. We show that within this framework a dominant color octet contribution to neutrinoless double beta decay is possible without being in conflict with constraints from lepton flavor violating processes. We furthermore compare the “direct” color octet contribution to neutrinoless double beta decay with the “indirect” contribution, namely the usual standard light Majorana neutrino exchange. For degenerate color octet fermionic states both contributions are proportional to the usual effective mass, while for non-degenerate octet fermions this feature is not present. Depending on the model parameters, either of the contributions can be dominant.

*email: sandhya@hri.res.in

†email: michael.duerr@mpi-hd.mpg.de

‡email: manimala.mitra@lngs.infn.it

§email: werner.rodejohann@mpi-hd.mpg.de

1 Introduction

The question regarding the origin of neutrino mass remains one of the most pressing problems in particle physics [1]. In particular, knowledge of whether neutrinos are Dirac or Majorana particles is of paramount importance. If neutrinos were to be Majorana particles, lepton number would be violated. Since lepton number is an accidental symmetry of the standard model of particle physics, one would like to know the scale of lepton number violation (LNV), if any, leading to the generation of neutrino masses. In addition, the peculiar pattern of neutrino masses and mixing demands an explanation which requires the extension of the standard model, and one would like to probe the existence of new particles usually considered within such extensions. While neutrino oscillations and beta decay experiments continue to improve our knowledge of the low energy neutrino mass matrix, we have to look at data from a variety of complementary avenues such as neutrinoless double beta decay ($0\nu\beta\beta$) experiments [2–5], lepton flavor violation searches [6, 7], as well as collider experiments to augment our understanding of the mechanism responsible for neutrino mass generation. On the experimental side, there are realistic prospects for order-of-magnitude improvements in the search for the $0\nu\beta\beta$ half-life [8]. Moreover, there has been an order-of-magnitude improvement on the bound for $\mu \rightarrow e\gamma$ recently [6].

While one usually assumes that the exchange of light Majorana neutrinos is the leading contribution to neutrinoless double beta decay [9], it is well known that a plethora of alternative intermediate scale theories exists (where the intermediate scale is TeV, few hundred GeV and even few tens of GeV), which not only predict neutrinoless double beta decay, but can also saturate the current bounds on the process, or can lead to sizable rates in current and future experiments [10–22]. Some of the interesting alternative approaches are based on seesaw models [19–21], left-right symmetric theories [18], R -parity violating supersymmetry [11–15] and so on. See the recent reviews [23] and [24] for summaries of the particle physics aspects and the experimental situation of $0\nu\beta\beta$, respectively. The fact that heavy TeV-scale particles can lead to the same contribution to $0\nu\beta\beta$ as sub-eV scale neutrinos is easily understood from looking at the particle physics amplitude in the standard interpretation of light neutrino exchange:

$$\mathcal{A}_l \simeq G_F^2 \left| \sum_i \frac{U_{ei}^2 m_i}{\langle p^2 \rangle - m_i^2} \right| \simeq (2.7 \text{ TeV})^{-5} . \quad (1)$$

Here we have inserted the current limit of about 0.5 eV on the effective neutrino mass $M_{ee} = |\sum U_{ei}^2 m_i|$, with U being the lepton mixing matrix, m_i the neutrino masses, and $\langle p^2 \rangle \simeq 0.01 \text{ GeV}^2 \gg m_i^2$ for the relevant momentum scale of the process in the neutrino propagator. Thus, if heavy particles with mass much larger than $\langle p^2 \rangle$ are exchanged in the process, for instance two scalars or vectors with mass M_1 and one fermion with mass M_2 , they will contribute with $\sim 1/(M_1^4 M_2)$ to the amplitude, and can saturate the current limit if their masses are in the TeV regime.

In this paper we work with a particular variant of the seesaw mechanism [25] which has TeV-scale scalar and fermionic color octets. The fermionic octets have a Majorana mass term leading to lepton number violation in the theory. Consequently, one expects that they will directly generate neutrinoless double beta decay. Neutrino masses are forbidden at tree level, however they are generated at one-loop level, via the exchange of color octet fermions and scalars. This model has been dubbed the "colored seesaw" model [26]. Since the new particles introduced in this model are color octets, sizable cross-sections at the LHC can be expected, connected with the spectacular feature of lepton number violation [27]. In addition, the lepton flavor violation associated with the gauge invariant Yukawa couplings of the octets [28] implies that not only the neutrino sector is non-trivial in what regards flavor, but also the charged lepton sector is. Hence, decays like $\mu \rightarrow e\gamma$ provide additional tests of the scenario [28], and the branching ratios depend on the same set of parameters as the neutrino mass matrix. Here, we discuss neutrinoless double beta decay and lepton flavor violation mediated by these color octet states, and show that they, being TeV-scale particles, can give a large and in fact saturating contribution in both processes. Note that the current collider limits on their masses are 1.92 TeV for the octet scalar [31], and about 1 TeV for the octet fermions [32].

The reason why these contributions have not been considered in the literature so far is that usually one assumes minimal flavor violation (MFV) to avoid large flavor changing neutral current (FCNC) effects [33]. Then, the coupling of the charged member in the weak doublet scalar octet to a quark q is proportional to m_q/v , with v being the vacuum expectation value (VEV) of the standard model Higgs. Therefore, the amplitude of $0\nu\beta\beta$ receives a

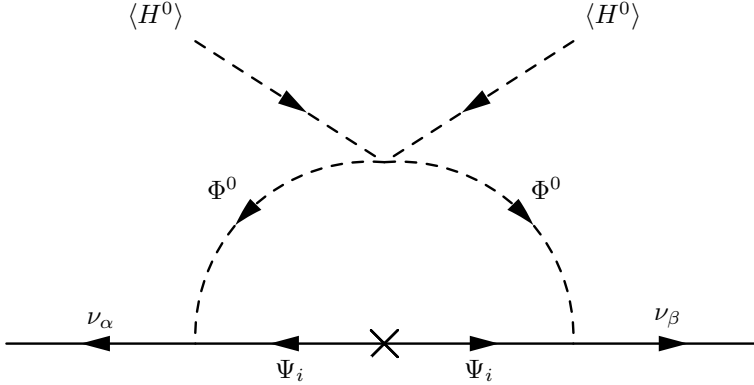

Figure 1: Neutrino mass generated at the one-loop level in the colored seesaw scenario.

suppression factor of $m_{u,d}^2/v^2$ and is completely negligible [26]. We depart from the assumption of minimal flavor violation in this work, and hence a sizable rate of $0\nu\beta\beta$ can come from the color octet states. In this framework, we study the interplay of neutrino mass and mixing, lepton flavor violation and neutrinoless double beta decay, and encounter several interesting and general features, which are characteristic for the correlations between the various phenomenological sectors.

One particularly interesting feature is the interplay of direct and indirect contributions of the color octets to $0\nu\beta\beta$. With “direct contribution” we mean the new contribution with exchange of heavy octets, while with “indirect contribution” we mean the usually considered light Majorana neutrino exchange mechanism, where here, however, the neutrino masses are generated by the octets via loops. While in general these two contributions depend differently on the parameters, we identify situations in which they are both proportional to the effective mass, namely when the fermionic octets are degenerate in mass. In other cases, they depend differently on the flavor parameters. In all cases, the neutrino exchange mechanism can be dominating or sub-leading, depending on the masses of the octets and the quartic coupling governing the interaction between the color octet scalar and the standard model Higgs boson.

The outline of the paper is the following: we start with the basics of the colored seesaw scenario in Section 2. Following this, in Section 3, we discuss the contribution of color octet states in neutrinoless double beta decay and lepton flavor violating processes in general, and consider in some detail the most simple case of two degenerate color octet fermions in Section 4. The general case of three non-degenerate color octet fermions is the subject of Section 5, before we conclude and summarize in Section 6.

2 Colored Seesaw Scenario

In the colored seesaw mechanism [26,27], the particle content of the standard model is extended with a color octet scalar Φ and color octet fermions Ψ_i , which transform as

$$\Phi \sim (8, 2, +1) ; \quad \Psi_i \sim (8, 1, 0). \quad (2)$$

While Φ is charged under $SU(2)_L$ and $U(1)_Y$, the fields Ψ_i are singlets under these gauge groups. Note that while the model just contains one additional scalar, we need at least two additional fermions in order to generate at least two massive light neutrinos which are required to explain current neutrino data. We will consider the cases $i = 1, 2$ and $i = 1, 2, 3$ in this paper. The relevant Lagrangian corresponding to the new sector is

$$-\mathcal{L}_\nu = Y_\nu^{\alpha i} \bar{L}_\alpha i\sigma_2 \text{Tr}(\Phi^* \Psi_i) + \frac{1}{2} M_{\Psi_i} \text{Tr}(\bar{\Psi}_i^c \Psi_i) + \lambda_{\Phi H} \text{Tr}(\Phi^\dagger H)^2 + \text{h.c.}, \quad (3)$$

where H is the standard model doublet Higgs and L_α is the lepton doublet of flavor $\alpha = e, \mu, \tau$, i.e., greek indices correspond to flavor and roman indices to physical mass states. We have considered $\lambda_{\Phi H}$ and M_{Ψ_i} as real. Since

the scalar Φ is a color octet and $SU(3)_c$ symmetry must remain unbroken, it must have a zero vacuum expectation value. Hence, it is evident from the above that at tree level one cannot generate the neutrino mass operator $\mathcal{O}(\frac{LHLH}{\Lambda})$ [29]. However, neutrino masses will be generated at one-loop level through the mediation of colored octet scalars and fermions, as shown in [26, 27] and illustrated in Fig. 1. The one-loop neutrino mass matrix is

$$M_\nu^{\alpha\beta} = \sum_i v^2 \frac{\lambda_{\Phi H}}{16\pi^2} Y_\nu^{\alpha i} Y_\nu^{\beta i} \mathcal{I}(M_\Phi, M_{\Psi_i}), \quad (4)$$

where the loop function \mathcal{I} is given by

$$\mathcal{I}_i \equiv \mathcal{I}(M_\Phi, M_{\Psi_i}) = M_{\Psi_i} \frac{M_\Phi^2 - M_{\Psi_i}^2 + M_{\Psi_i}^2 \ln\left(\frac{M_{\Psi_i}^2}{M_\Phi^2}\right)}{(M_\Phi^2 - M_{\Psi_i}^2)^2}. \quad (5)$$

Here, M_Φ is the mass of the scalar octet, and $v = 174$ GeV is the doublet Higgs VEV. The neutrino mass matrix in Eq. (4) can be diagonalized by the unitary 3×3 Pontecorvo–Maki–Nakagawa–Sakata (PMNS) mixing matrix U , where according to our convention $U^\dagger M_\nu U^* = M_\nu^d = \text{diag}(m_1, m_2, m_3)$, with m_i being the light neutrino masses. Using this and Eq. (4), one can express the Yukawa coupling matrix Y_ν in terms of light neutrino masses, mixings, color octet masses and a Casas–Ibarra [30] matrix \mathcal{R} as:

$$Y_\nu = \sqrt{\frac{16\pi^2}{\lambda_{\Phi H}}} \frac{1}{v} U \sqrt{M_\nu^d} \mathcal{R} \sqrt{(\mathcal{I}^d)^{-1}}, \quad (6)$$

where $\mathcal{I}^d = \text{diag}(\mathcal{I}_1, \mathcal{I}_2, \mathcal{I}_3)$. In general, we can express the complex orthogonal matrix \mathcal{R} as

$$\mathcal{R} = \begin{pmatrix} \hat{c}_2 \hat{c}_3 & \hat{c}_2 \hat{s}_3 & \hat{s}_2 \\ -\hat{c}_1 \hat{s}_3 - \hat{s}_1 \hat{s}_2 \hat{c}_3 & \hat{c}_1 \hat{c}_3 - \hat{s}_1 \hat{s}_2 \hat{s}_3 & \hat{s}_1 \hat{c}_2 \\ \hat{s}_1 \hat{s}_3 - \hat{c}_1 \hat{s}_2 \hat{c}_3 & -\hat{s}_1 \hat{c}_3 - \hat{c}_1 \hat{s}_2 \hat{s}_3 & \hat{c}_1 \hat{c}_2 \end{pmatrix}, \quad (7)$$

with $\hat{s}_i = \sin \hat{\theta}_i$, $\hat{c}_i = \cos \hat{\theta}_i$ ($i = 1, 2, 3$), where $\hat{\theta}_1$, $\hat{\theta}_2$ and $\hat{\theta}_3$ are arbitrary complex angles. Since the color octet scalar field Φ is charged under $SU(3)_c$ as well as $SU(2)_L$ and $U(1)_Y$, it can interact with the quark fields of the standard model. Note that the scalar field Φ can be decomposed as

$$\Phi = \lambda^A \begin{pmatrix} \Phi^+ \\ \Phi^0 \end{pmatrix}_A; \quad \Phi^0 = \Phi_r^0 + i\Phi_i^0, \quad (8)$$

where the λ^A , $A = 1, \dots, 8$, are the Gell-Mann matrices. The Lagrangian corresponding to the interaction between the quarks and the scalar Φ is

$$\mathcal{L}_Q = \bar{d}_R \kappa_D \Phi^\dagger Q_L + \bar{u}_R \kappa_U Q_L \Phi + \text{h.c.}, \quad (9)$$

where $\kappa_{U,D}$ are the corresponding Yukawa couplings. Going from the flavor basis to the physical basis of the quark fields ($U_{L,R}$ and $D_{L,R}$ are the bases rotation matrices for the up and down quarks, respectively), the Lagrangian is

$$\begin{aligned} \mathcal{L}_Y = & \bar{d} \left[P_L \left(D_R^\dagger \kappa_D U_L \right) - P_R \left(D_L^\dagger \kappa_U U_R \right) \right] \Phi^- u + \bar{u} \left[P_R \left(U_L^\dagger \kappa_D^\dagger D_R \right) - P_L \left(U_R^\dagger \kappa_U D_L \right) \right] \Phi^+ d \\ & + \frac{\Phi_r^0}{\sqrt{2}} \bar{d} \left[P_L \left(D_R^\dagger \kappa_D D_L \right) + P_R \left(D_L^\dagger \kappa_D^\dagger D_R \right) \right] d + \frac{\Phi_i^0}{\sqrt{2}} \bar{u} \left[P_L \left(U_R^\dagger \kappa_U U_L \right) + P_R \left(U_L^\dagger \kappa_U^\dagger U_R \right) \right] u \\ & - i \frac{\Phi_i^0}{\sqrt{2}} \bar{d} \left[P_L \left(D_R^\dagger \kappa_D D_L \right) - P_R \left(D_L^\dagger \kappa_D^\dagger D_R \right) \right] d + i \frac{\Phi_i^0}{\sqrt{2}} \bar{u} \left[P_L \left(U_R^\dagger \kappa_U U_L \right) - P_R \left(U_L^\dagger \kappa_U^\dagger U_R \right) \right] u. \end{aligned} \quad (10)$$

We choose the basis where the up-quark mass matrix is diagonal, i.e., the up-quark mixing matrices are $U_{L,R} = \mathbb{1}$. Using this, the above equation simplifies to

$$\begin{aligned} \mathcal{L}_Y = & \bar{d} \left[P_L \left(D_R^\dagger \kappa_D \right) - P_R \left(D_L^\dagger \kappa_U^\dagger \right) \right] \Phi^- u + \bar{u} \left[P_R \left(\kappa_D^\dagger D_R \right) - P_L \left(\kappa_U D_L \right) \right] \Phi^+ d \\ & + \frac{\Phi_r^0}{\sqrt{2}} \bar{d} \left[P_L \left(D_R^\dagger \kappa_D D_L \right) + P_R \left(D_L^\dagger \kappa_D^\dagger D_R \right) \right] d + \frac{\Phi_i^0}{\sqrt{2}} \bar{u} \left[P_L \left(\kappa_U \right) + P_R \left(\kappa_U^\dagger \right) \right] u \\ & - i \frac{\Phi_i^0}{\sqrt{2}} \bar{d} \left[P_L \left(D_R^\dagger \kappa_D D_L \right) - P_R \left(D_L^\dagger \kappa_D^\dagger D_R \right) \right] d + i \frac{\Phi_i^0}{\sqrt{2}} \bar{u} \left[P_L \left(\kappa_U \right) - P_R \left(\kappa_U^\dagger \right) \right] u. \end{aligned} \quad (11)$$

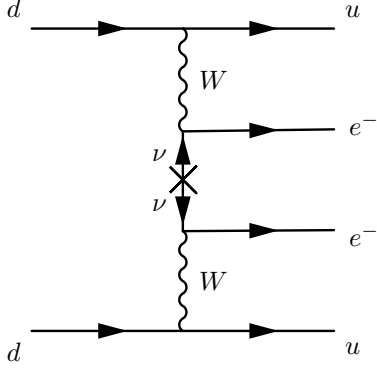

Figure 2: Neutrinoless double beta decay mediated by light Majorana neutrinos.

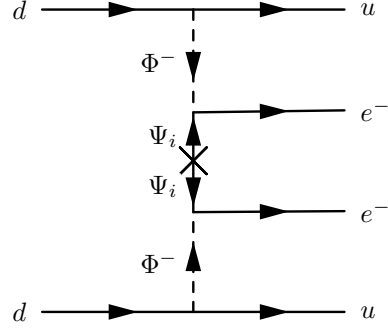

Figure 3: Neutrinoless double beta decay mediated by color octet scalars and fermions.

After describing the basic Lagrangian in this section, we now discuss the different processes where these color octet states can participate. In particular, we concentrate on the novel color octet contribution to neutrinoless double beta decay and on lepton flavor violating processes like $\mu \rightarrow e\gamma$. We will show in particular that the color octet framework for neutrino mass generation can easily saturate both the $\mu \rightarrow e\gamma$ limit as well as the limit on neutrinoless double beta decay.

3 Neutrinoless Double Beta Decay and Flavor Violation

The standard light neutrino contribution to $0\nu\beta\beta$ is given in Fig. 2. It is proportional to the effective mass $M_{ee} = \sum U_{ei}^2 m_i$. We note in this paper that the scalar and fermionic states will also contribute in this lepton number violating process, as shown in Fig. 3. The conceptually interesting part is that there is a direct and an indirect contribution from the octets. The direct one is the new diagram from Fig. 3, while the indirect one is the neutrino exchange mechanism in Fig. 2. It is called indirect because the light neutrino masses are generated by the octets in the loop diagram given in Fig. 1. The relevant vertices for the direct contribution of the octets to $0\nu\beta\beta$ are

$$\lambda_{\alpha\beta}^A \bar{u}^\alpha \left[P_R (\kappa_D^\dagger D_R)_{11} - P_L (\kappa_U D_L)_{11} \right] \Phi_A^+ d^\beta \text{ and } Y_\nu^{ei} \bar{e}_L (\Phi^+)^* \Psi_i, \quad (12)$$

so that the relevant effective operator for $0\nu\beta\beta$ is $\langle uuee | \mathcal{L}_{\text{eff}}^{\Delta L_e=2}(x) | dd \rangle$, where $\mathcal{L}_{\text{eff}}^{\Delta L_e=2}(x)$ is

$$(Y_\nu^{ei})^2 \frac{1}{M_\Phi^4 M_\Psi} \lambda_{\alpha\beta} \lambda_{\gamma\delta} \left[\bar{u}^\alpha \left(P_R (\kappa_D^\dagger D_R)_{11} - P_L (\kappa_U D_L)_{11} \right) d^\beta \right] \left[\bar{u}^\gamma \left(P_R (\kappa_D^\dagger D_R)_{11} - P_L (\kappa_U D_L)_{11} \right) d^\delta \right] (\bar{e}_L e_L^c). \quad (13)$$

For simplicity, and for illustration, we consider the case where $\kappa_U \ll \kappa_D$ and concentrate on the right-chiral part only. We denote the contribution coming from the quark states as $\tilde{y}_{11}^2 = y_{11}^2 \beta$, where $y_{11} = (\kappa_D^\dagger D_R)_{11}$, and the factor β can come from the hadronization procedure. The inverse half-life of $0\nu\beta\beta$ is given by the well-known expression

$$\frac{1}{T_{1/2}} = G_{0\nu} |\mathcal{M}_\nu \eta_\nu + \mathcal{M}_{\Phi\Psi} \eta_{\Phi\Psi}|^2, \text{ where } \eta_\nu = \frac{\sum_i U_{ei}^2 m_i}{m_e} \text{ and } \eta_{\Phi\Psi} = \frac{m_p}{G_F^2 M_\Phi^4} \sum_i \frac{(Y_\nu^{ei})^2}{M_{\Psi_i}}. \quad (14)$$

Here \mathcal{M}_ν and $\mathcal{M}_{\Phi\Psi}$ are the nuclear matrix elements corresponding to the light neutrino exchange (indirect contribution) and to the exchange of color octets (direct contribution). We will focus here for definiteness on the neutrinoless double beta decay of ^{76}Ge , for which a half-life limit of $T_{1/2} \geq 1.9 \times 10^{25}$ yr exists [2]. The phase space factor is $G_{0\nu} = 7.93 \times 10^{-15} \text{ yr}^{-1}$. Alternatively, one can give the above expression as:

$$\frac{1}{T_{1/2}} = \mathcal{K}_{0\nu} \left| \frac{M_{ee}}{P^2} + \frac{\tilde{y}_{11}^2}{M_\Phi^4 G_F^2} \sum_i \frac{(Y_\nu^{ei})^2}{M_{\Psi_i}} \right|^2. \quad (15)$$

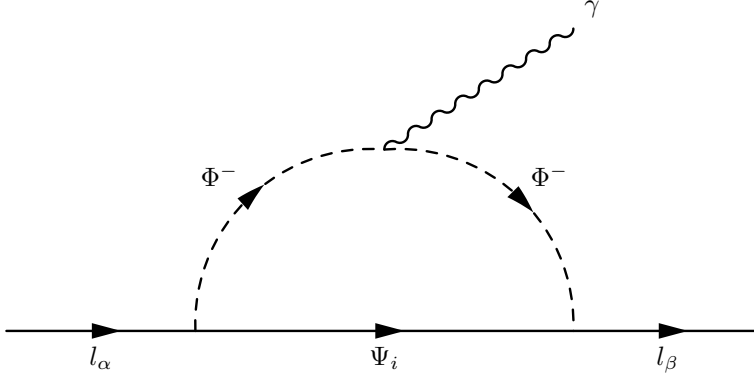

Figure 4: Lepton flavor violating process $l_\alpha \rightarrow l_\beta \gamma$ in the colored seesaw scenario.

In the above, $\mathcal{K}_{0\nu} = G_{0\nu}(\mathcal{M}_{\Phi\Psi}m_p)^2$, $P^2 = m_e m_p \frac{\mathcal{M}_{\Phi\Psi}}{\mathcal{M}_\nu}$ and $G_F = 1.166 \times 10^{-5} \text{ GeV}^{-2}$ is the Fermi constant. The parameter P^2 describes the difference between the long- and short-range contributions.

It is also instructive to compare the amplitudes for neutrinoless double beta decay on the *particle physics level*:

$$\mathcal{A}_l \simeq G_F^2 \frac{M_{ee}}{\langle p^2 \rangle}, \quad \mathcal{A} \simeq \frac{y_{11}^2}{M_\Phi^4} \sum_i \frac{(Y_\nu^{ei})^2}{M_{\Psi_i}}.$$

Here \mathcal{A} is the amplitude for the direct contribution (color octet exchange) and \mathcal{A}_l the indirect contribution due to the light Majorana neutrino exchange. We deal with a nuclear physics problem here, so that a typical size of the momentum is $\langle p^2 \rangle \approx (100 \text{ MeV})^2$. Comparing different amplitudes on the particle physics level is very often an excellent approximation to compare their relative contribution to $0\nu\beta\beta$. With the help of the complex orthogonal matrix \mathcal{R} one can re-write the color octet amplitude in terms of the PMNS matrix:

$$\mathcal{A} \simeq \frac{16\pi^2}{\lambda_{\Phi H} v^2} \frac{y_{11}^2}{M_\Phi^4} \left(\sum_i m_i U_{ei}^2 \sum_j \frac{\mathcal{R}_{ij}^2}{M_{\Psi_j} \mathcal{I}_j^d} + 2 \sum_{j < i} \sqrt{m_i m_j} U_{ei} U_{ej} \sum_k \frac{\mathcal{R}_{ik} \mathcal{R}_{jk}}{M_{\Psi_k} \mathcal{I}_k^d} \right). \quad (16)$$

One can immediately see from this expression that for degenerate fermion octets, i.e., for $M_{\Psi_k} = M_\Psi$ the elements of \mathcal{R} drop out of this expression and the amplitude is proportional to $M_{ee} = \sum m_i U_{ei}^2$. Therefore, if the fermion octets are degenerate, both the direct as well as the indirect contributions to $0\nu\beta\beta$ are directly proportional to the effective mass M_{ee} . As a result, if due to any cancellation the contribution from light neutrino exchange goes to zero, the corresponding contribution from the octet exchange also vanishes identically. However barring these cancellations due the Majorana phases, we will see that the relative importance of the two contributions may widely vary depending on the model parameters.

Let us point out that in some sense $0\nu\beta\beta$ and the generation of neutrino masses can be decoupled in this model. It can be seen from Eqs. (3) and (9) that two independent sources of lepton number violation exist. The first term of Eq. (3) may be used to assign lepton number to the color octet particles, and the last two terms then break it. If $\lambda_{\Phi H}$ is zero, we can assign lepton number either to Φ or to Ψ_i . In the first case (assigning lepton number to Φ) the quark couplings to Φ in Eq. (9) provide LNV; in the second case (assigning lepton number to Ψ_i), the colored fermion mass term gives LNV. If now $\lambda_{\Phi H} = 0$, the one-loop neutrino masses in Eq. (4) vanish¹, but still there are non-vanishing contributions to $0\nu\beta\beta$.

Besides neutrinoless double beta decay, the color octets can actively participate in different lepton flavor violating processes, like $\mu \rightarrow e\gamma$, $\tau \rightarrow e\gamma$ and $\tau \rightarrow \mu\gamma$, as shown in Fig. 4. The branching ratio corresponding to $l_\alpha \rightarrow l_\beta \gamma$ is [26–28]

$$\text{Br}(l_\alpha \rightarrow l_\beta \gamma) = \frac{3\alpha_{\text{em}}}{4\pi G_F^2 M_\Phi^4} \left| \sum_i Y_\nu^{\beta i} (Y_\nu^{\alpha i})^* \mathcal{F}(x_i) \right|^2, \quad (17)$$

¹Since lepton number is not conserved, higher order diagrams will lead to very small neutrino masses.

where the function $\mathcal{F}(x_i)$ has the following form,

$$\mathcal{F}(x_i) = \frac{1 - 6x_i + 3x_i^2 + 2x_i^3 - 6x_i^2 \ln(x_i)}{12(x_i - 1)^4}, \quad (18)$$

with $x_i = M_{\Psi_i}^2/M_{\Phi}^2$ and α_{em} being the fine structure constant. As for the case of the $0\nu\beta\beta$ amplitude, one can write the branching ratio of $\mu \rightarrow e\gamma$ in terms of the neutrino parameters and the matrix \mathcal{R} as

$$\text{Br}(\mu \rightarrow e\gamma) = \frac{3\alpha_{\text{em}}}{4\pi G_F^2 M_{\Phi}^4} \frac{(16\pi^2)^2}{\lambda_{\Phi H}^2 v^4} \left| \sum_k \frac{\mathcal{F}(x_k)}{\mathcal{I}_k} \sum_{i,j} U_{ei} U_{\mu j}^* \mathcal{R}_{ik} \mathcal{R}_{jk}^* \sqrt{m_i m_j} \right|^2. \quad (19)$$

For the simple choice of $\mathcal{R}_{ij} = \delta_{ij}$, the above expression reduces to

$$\text{Br}(\mu \rightarrow e\gamma) = \frac{3\alpha_{\text{em}}}{4\pi G_F^2 M_{\Phi}^4} \frac{(16\pi^2)^2}{\lambda_{\Phi H}^2 v^4} \left| \sum_i \frac{\mathcal{F}(x_i)}{\mathcal{I}_i} U_{ei} U_{\mu i}^* m_i \right|^2. \quad (20)$$

In fact, one can check that the branching ratio is independent of \mathcal{R} if the fermion octets are degenerate and \mathcal{R} is real. Since \mathcal{R} embodies our lack of knowledge of the seesaw-scale physics which cannot be determined from low-scale data, we can immediately see that for such a class of model parameters the theory is fully determined leading to unambiguous prediction for lepton flavor violating decays. Currently, the best limit on lepton flavor violation comes from the MEG collaboration, which gives [6]

$$\text{Br}(\mu \rightarrow e\gamma) \leq 2.4 \times 10^{-12} \quad (21)$$

at 90% C.L. In what follows we will discuss some simple examples for the interplay of neutrino mixing, neutrinoless double beta decay and lepton flavor violation. While this is not a complete analysis, some very interesting and general features arise.

4 Neutrinoless Double Beta Decay and Lepton Flavor Violation with Two Color Octet Fermions

In this section, we discuss neutrinoless double beta decay and lepton flavor violating processes, considering the minimal case with two degenerate color octet fermions. Thus the matrix \mathcal{R} depends on only one complex parameter and can be taken as

$$\mathcal{R}(\text{for NH}) = \begin{pmatrix} 0 & 0 \\ \sqrt{1-\omega^2} & -\omega \\ \omega & \sqrt{1-\omega^2} \end{pmatrix} \text{ and } \mathcal{R}(\text{for IH}) = \begin{pmatrix} \sqrt{1-\omega^2} & -\omega \\ \omega & \sqrt{1-\omega^2} \\ 0 & 0 \end{pmatrix}. \quad (22)$$

In our analysis we consider a real ω and hence, $-1 \leq \omega \leq +1$. Note that since we need one heavy fermion for each light neutrino, this results in the lightest neutrino mass being zero. We first discuss the normal hierarchy and then the inverted hierarchy scenario.

4.1 Normal Hierarchy

For the normal hierarchy scenario and two color octet fermions with degenerate masses, i.e., $M_{\Psi_i} = M_{\Psi}$ (and hence $\mathcal{I}_i = \mathcal{I}$) for all i , the Yukawas can be expressed as

$$Y_{\nu} = \sqrt{\frac{16\pi^2}{\lambda_{\Phi H}}} \frac{1}{v} U \text{diag}(0, \sqrt{m_2}, \sqrt{m_3}) \mathcal{R} \text{diag}(\sqrt{\mathcal{I}^{-1}}, \sqrt{\mathcal{I}^{-1}}). \quad (23)$$

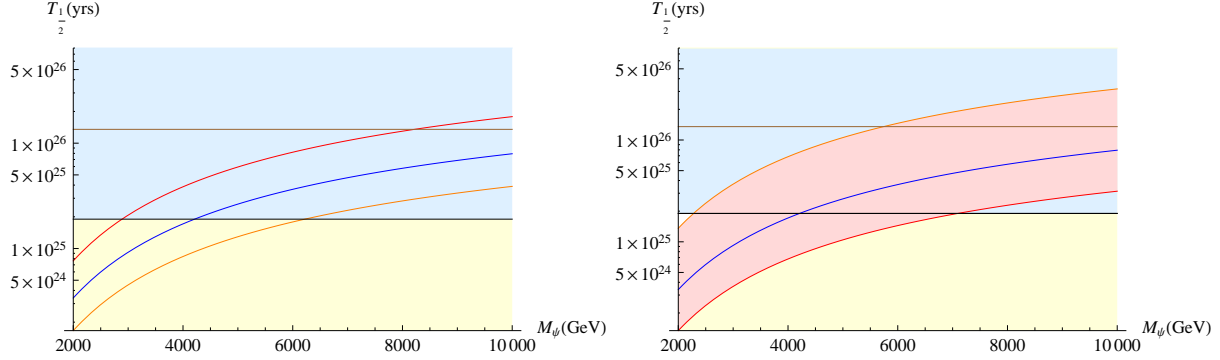

Figure 5: Half-life $T_{1/2}$ of ^{76}Ge against the mass of the color octet fermion M_{Ψ} . The mass of scalar octet has been fixed as $M_{\Phi} = 1.96$ TeV. In the left plot, the red, blue and orange lines correspond to $\lambda_{\Phi H} = 0.15 \times 10^{-8}$, $\lambda_{\Phi H} = 0.1 \times 10^{-8}$, and $\lambda_{\Phi H} = 0.7 \times 10^{-9}$, respectively. The yellow region is experimentally excluded. The black line corresponds to the Heidelberg–Moscow limit. The brown line represents the light neutrino contribution to neutrinoless double beta decay divided by 50^2 , for the neutrino oscillation parameters mentioned in the text. In the right plot the red, blue and orange lines correspond to the three different nuclear matrix elements $\mathcal{M}_{\Phi\Psi} = 600.38$, $\mathcal{M}_{\Phi\Psi} = 377.59$, and $\mathcal{M}_{\Phi\Psi} = 188.79$, respectively. The coupling has been set to $\lambda_{\Phi H} = 10^{-9}$. Both figures are for normal hierarchy.

Expressed in terms of the elements of the PMNS mixing matrix U , the light neutrino mass eigenvalues m_i and the quartic coupling $\lambda_{\Phi H}$, the corresponding half-life for $0\nu\beta\beta$ can be written as

$$\frac{1}{T_{1/2}} = \mathcal{K}_{0\nu} \left(\frac{1}{P^2} + \frac{\tilde{y}_{11}^2}{M_{\Psi} M_{\Phi}^4 G_F^2 v^2 \lambda_{\Phi H} \mathcal{I}} \right)^2 |m_2 U_{e2}^2 + m_3 U_{e3}^2|^2. \quad (24)$$

As discussed in the previous section, since we have considered degenerate fermions, the expression for the half-life of neutrinoless double beta decay is independent of the parameter ω , although the Yukawa couplings depend strongly on it. We also stress again that for the case of degenerate octet fermions both the light neutrino contribution and the color octet contributions share the same proportionality factor $|M_{ee}| = |m_2 U_{e2}^2 + m_3 U_{e3}^2|$. Hence, if due to any cancellation between neutrino parameters the light neutrino contribution becomes zero, the same cancellation will set the color octet contribution to zero, too. However, for $M_{ee} \neq 0$ the direct contribution from the color octets can be taken independently of the neutrino mass scale. This is because there is an additional parameter $\lambda_{\Phi H}$ in addition to the Yukawa coupling involved, and hence one can suitably adjust the two to get small enough neutrino masses required for normal hierarchy and yet get a very large contribution to $0\nu\beta\beta$. In particular, by choosing the coupling $\lambda_{\Phi H}$ to smaller values, the color octet contribution can dominate over the light neutrino contribution. We have shown the relative comparison between the light neutrino and color octet contributions in Fig. 5, where we have plotted the variation of the half-life $T_{1/2}$ vs. the mass of the color octet fermion M_{Ψ} . The details of the figure are as follows:

- We used the neutrino oscillation parameters $\Delta m_{21}^2 = 7.5 \times 10^{-5} \text{ eV}^2$, $\Delta m_{31}^2 = 2.3 \times 10^{-3} \text{ eV}^2$, $\theta_{12} = 33^\circ$, $\theta_{23} = 42^\circ$ and $\theta_{13} = 8^\circ$, see Ref. [35] for a recent global fit. For this choice of parameters, the effective mass is $M_{ee} = 0.003 \text{ eV}$. The elements U_{e2} and U_{e3} have been considered real.
- The mass of the scalar octet has been fixed as $M_{\Phi} = 1.96 \text{ TeV}$, so that it satisfies the present bound on the mass of color octet scalars [31]. However, in [31] the bound has been derived assuming negligible coupling with quarks, i.e., production in the gluon fusion channel. In our case, the color octet scalar has interaction with the quarks, hence the mass bound may be weakened.
- The black line represents the Heidelberg–Moscow limit [2] for neutrinoless double beta decay and corresponds to $T_{1/2} = 1.9 \times 10^{25} \text{ yr}$. The yellow region is thus excluded, while the blue region is the allowed one.

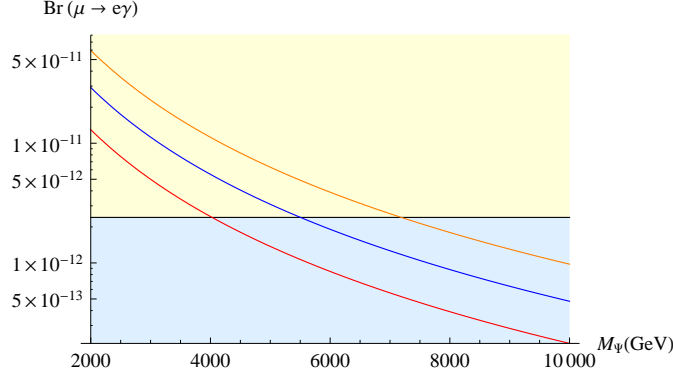

Figure 6: Branching ratio of $\mu \rightarrow e\gamma$ as a function of the octet fermion mass M_Ψ for normal hierarchy. The mass of scalar octet has been fixed as $M_\Phi = 1.96$ TeV. The red, blue and orange lines correspond to three different values $\lambda_{\Phi H} = 0.15 \times 10^{-8}$, $\lambda_{\Phi H} = 0.1 \times 10^{-8}$, and $\lambda_{\Phi H} = 0.7 \times 10^{-9}$. The yellow region is experimentally excluded. The black line corresponds to the present bound from the MEG experiment.

- The brown line represents the standard light neutrino contribution to $0\nu\beta\beta$ scaled by a factor 50^2 , i.e., $\mathcal{K}_{0\nu}^{-1} \left(\frac{M_{ee}}{P^2}\right)^{-2} \times \frac{1}{50^2}$, where we have taken $P^2 \sim (251.49)^2 \text{ MeV}^2$. The factor $\mathcal{K}_{0\nu}$ depends on the nuclear matrix element and can be obtained using $\mathcal{K}_{0\nu} = G_{0\nu}(\mathcal{M}_{\Phi\Psi}m_p)^2$. We have taken $\tilde{y}_{11}^2 = 1$ and adopted the nuclear matrix elements from [13–15], where $\mathcal{M}_\nu = 2.8$, and following Eq. (A.8) in [15], $\mathcal{M}_{\Phi\Psi} = 377.59$, if the pion exchange and usual one and two nucleon mode are considered. For this value of $M_{\Phi\Psi}$, $\mathcal{K}_{0\nu} = 9.95 \times 10^{-10} \text{ yr}^{-1} \text{ GeV}^2$ and the standard contribution is $\mathcal{K}_{0\nu}^{-1} \left(\frac{M_{ee}}{P^2}\right)^{-2} = 3.38 \times 10^{29} \text{ yr}$. These $0\nu\beta\beta$ -matrix element values are the ones which have been evaluated for the case of short range R -parity violating SUSY diagrams, which is closest to the setup considered by us. In particular, the operator structure which corresponds to λ'_{111} diagrams is similar to our case. Hence the information regarding nuclear matrix element for R -parity violation can be utilized in our scenario.
- The red, blue and orange lines correspond to the values $\lambda_{\Phi H} = 0.15 \times 10^{-8}$, $\lambda_{\Phi H} = 0.1 \times 10^{-8}$ and $\lambda_{\Phi H} = 0.7 \times 10^{-9}$, respectively. The half-life decreases with $\lambda_{\Phi H}$.
- In Fig. 5, we have also shown the variation of $T_{1/2}$ with the mass of the color octet fermion, considering the variation of nuclear matrix element $\mathcal{M}_{\Phi\Psi}$ in the interval $188.79 - 600.38$.

The figure clearly shows that the direct octet contribution can dominate the contribution from light neutrino exchange easily, which, we reiterate, has been shown by dividing by a factor of $(50)^2$. It is also clear that the direct octet contribution can easily saturate the current limit on the half-life of $0\nu\beta\beta$, even for normal hierarchy. Note that the prediction for $0\nu\beta\beta$ with light Majorana neutrino exchange for normal hierarchy is very low compared to that for inverted hierarchy, and much below the reach of the next generation $0\nu\beta\beta$ experiments. However, since in the colored seesaw model one can have very large $0\nu\beta\beta$ even for normal hierarchy, $0\nu\beta\beta$ can no longer be used distinguish between the neutrino mass hierarchies.

Having discussed lepton number violation, we turn to lepton flavor violation now. We are interested in exploring if the color-octet fermions can simultaneously produce a $0\nu\beta\beta$ rate large enough to saturate the current limit, and at the same time saturate the experimental bound for $\mu \rightarrow e\gamma$. The branching ratio for this process has been given in Eq. (19). We stick to real ω and degenerate fermions and hence the branching ratio becomes independent of the parameter ω . It has the following form:

$$\text{Br}(\mu \rightarrow e\gamma) = \frac{3\alpha_{\text{em}}}{4\pi G_F^2 M_\Phi^4} \frac{(16\pi^2)^2}{\lambda_{\Phi H}^2 v^4} \left(\frac{\mathcal{F}(x)}{\mathcal{I}}\right)^2 |m_2 U_{e2} U_{\mu 2}^* + m_3 U_{e3} U_{\mu 3}^*|^2. \quad (25)$$

Like in neutrinoless double beta decay, the color octet fermions can also give a significant contribution to this process. The result has been shown in Fig. 6, where we have given the variation of the branching ratio against the

mass of the color octet fermions, considering three different values of $\lambda_{\Phi H}$. The summary of the figure is as follows:

- The neutrino oscillation parameters as well as the mass of scalar octet have been set to the previously mentioned values, already used in the $0\nu\beta\beta$ study. For $\theta_{12} = 33^\circ$, $\theta_{23} = 42^\circ$, $\theta_{13} = 8^\circ$, $\Delta m_{21}^2 = 7.5 \times 10^{-5} \text{ eV}^2$ and $\Delta m_{31}^2 = 2.3 \times 10^{-3} \text{ eV}^2$, we have $(m_2 U_{e2} U_{\mu 2} + m_3 U_{e3} U_{\mu 3}) = 7.1 \times 10^{-12} \text{ GeV}$. The elements of the mixing matrix have been considered real.
- The black line corresponds to the present bound coming from $\mu \rightarrow e\gamma$ searches at MEG experiment, i.e., $\text{Br}(\mu \rightarrow e\gamma) = 2.4 \times 10^{-12}$.
- The red, blue and orange lines correspond to the values $\lambda_{\Phi H} = 0.15 \times 10^{-8}$, $\lambda_{\Phi H} = 0.1 \times 10^{-8}$, and $\lambda_{\Phi H} = 0.7 \times 10^{-9}$, respectively.

It is clear from the figure that one can rather easily saturate the current lepton flavor violation limits. Note that in principle the expression $|m_2 U_{e2} U_{\mu 2}^* + m_3 U_{e3} U_{\mu 3}^*|$, and thus the branching ratio for $\mu \rightarrow e\gamma$, can vanish if the mixing parameters and CP phase conspire. This would also be possible when we considered complex \mathcal{R} .

If the color octet contribution saturates both the Heidelberg–Moscow bound, as well as the present bound on $\mu \rightarrow e\gamma$ decay coming from MEG experiment, then the mass of the scalar and fermionic octets, and the coupling $\lambda_{\Phi H}$ should satisfy simultaneously the following two equations:

$$\begin{aligned}\lambda_{\Phi H} &= 1.63 \times 10^{20} \frac{\sqrt{\mathcal{K}_{0\nu}}}{M_\Psi M_\Phi^4} \tilde{y}_{11}^2 \frac{|m_2 U_{e2}^2 + m_3 U_{e3}^2|}{\mathcal{I}}, \\ \lambda_{\Phi H} &= 1.18 \times 10^7 \frac{\mathcal{F}(x)}{\mathcal{I}} \frac{|m_2 U_{e2} U_{\mu 2}^* + m_3 U_{e3} U_{\mu 3}^*|}{M_\Phi^2}.\end{aligned}\tag{26}$$

We have represented the above two conditions in Fig. 7, where we have shown the variation of $\lambda_{\Phi H}$ against the mass of the color octet fermions M_Ψ . As before, the mass of the scalar octet and $\mathcal{K}_{0\nu}$ have been set to be the same value as for Fig. 5. For simplicity, we have considered the elements of the PMNS mixing matrices to be real. In Fig. 7, the gray region is excluded both from $0\nu\beta\beta$ and $\mu \rightarrow e\gamma$. The red and blue lines in the left panel correspond to $\text{Br}(\mu \rightarrow e\gamma) = 2.4 \times 10^{-12}$, and the $0\nu\beta\beta$ saturating bound $T_{1/2} = 1.9 \times 10^{25} \text{ yr}$, where the Yukawas between scalar octets and quarks have been considered $\mathcal{O}(1)$. The same exercise has been repeated for the right panel of Fig. 7 with a different \tilde{y}_{11}^2 factor. Note that with the decrease of \tilde{y}_{11}^2 , one will require an additional suppression in $|m_2 U_{e2} U_{\mu 2}^* + m_3 U_{e3} U_{\mu 3}^*|$ in order to simultaneously saturate the MEG and Heidelberg–Moscow limit. This can come from cancellation between the phases. Also, interestingly Fig. 7 indicates that if only lepton flavor violation is saturating, the color octet fermions can be within the reach of LHC. However, inclusion of a saturating $0\nu\beta\beta$ demands the color-octet fermion mass to be higher.

4.2 Inverted Hierarchy

We discuss briefly the relative comparison of neutrinoless double beta decay and $\mu \rightarrow e\gamma$ when the light neutrino states follow the inverted hierarchy. The half-life for $0\nu\beta\beta$ can then be expressed as

$$\frac{1}{T_{1/2}} = \mathcal{K}_{0\nu} \left(\frac{1}{P^2} + \frac{\tilde{y}_{11}^2}{M_\Psi M_\Phi^4 G_F^2} \frac{16\pi^2}{v^2 \lambda_{\Phi H} \mathcal{I}} \right)^2 |m_1 U_{e1}^2 + m_2 U_{e2}^2|^2,\tag{27}$$

and the branching ratio for $\mu \rightarrow e\gamma$ is given by

$$\text{Br}(\mu \rightarrow e\gamma) = \frac{3\alpha_{\text{em}}}{4\pi G_F^2 M_\Phi^4} \frac{(16\pi^2)^2}{\lambda_{\Phi H}^2 v^4} \left(\frac{\mathcal{F}(x)}{\mathcal{I}} \right)^2 |m_1 U_{e1} U_{\mu 1}^* + m_2 U_{e2} U_{\mu 2}^*|^2.\tag{28}$$

Since, in general even for light neutrino states, the contribution for inverted hierarchy is larger than the contribution for normal hierarchy, the same feature holds for the colored seesaw scenario with degenerate fermions. One can obtain a significantly large neutrinoless double beta decay contribution with relatively small values of quark Yukawas, and/or larger color octet scalar and fermion masses. For completeness, we show two figures to support

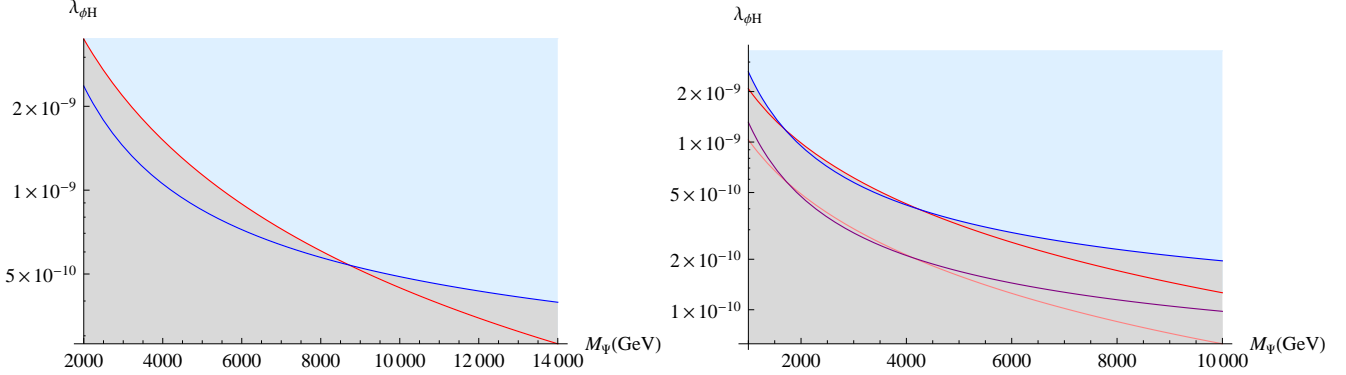

Figure 7: The coupling $\lambda_{\phi H}$ against the mass of the color octet fermions M_Ψ . The mass of scalar octet has been fixed as $M_\Phi = 1.96$ TeV. The gray band is experimentally excluded by $\mu \rightarrow e\gamma$ and $0\nu\beta\beta$. Left panel: the red line represents the present limit obtained by the MEG experiment for $\mu \rightarrow e\gamma$. The blue line represents the Heidelberg–Moscow bound. The factor \tilde{y}_{11}^2 has been considered to be 1. Right panel: The blue and purple lines correspond to the Heidelberg–Moscow bound, while the \tilde{y}_{11}^2 factor has been considered as 0.4 and 0.2 respectively. The red and pink lines correspond to the MEG limit, while we have considered a suppression factor 0.08 and 0.0197 from the factor $|m_2 U_{e2} U_{\mu 2}^* + m_3 U_{e3} U_{\mu 3}^*|^2$. The figure has been generated considering normal hierarchy.

this feature. See Figs. 8 and 9 for more details. All parameters except the ones explicitly mentioned in the captions are the same as for the previous figures.

We would like to end this section by discussing the particular relations which the different lepton flavor violating processes share among themselves in the special case considered here. The ratio of the branching ratios for different lepton flavor violating processes are

$$\frac{\text{Br}(\tau \rightarrow e\gamma)}{\text{Br}(\mu \rightarrow e\gamma)} = \frac{(U_{e2} U_{\tau 2}^* m_2 + U_{e3} U_{\tau 3}^* m_3)}{(U_{e2} U_{\mu 2}^* m_2 + U_{e3} U_{\mu 3}^* m_3)}, \quad \frac{\text{Br}(\tau \rightarrow \mu\gamma)}{\text{Br}(\mu \rightarrow e\gamma)} = \frac{(U_{\mu 2} U_{\tau 2}^* m_2 + U_{\mu 3} U_{\tau 3}^* m_3)}{(U_{e2} U_{\mu 2}^* m_2 + U_{e3} U_{\mu 3}^* m_3)} \quad (29)$$

for normal hierarchy, and

$$\frac{\text{Br}(\tau \rightarrow e\gamma)}{\text{Br}(\mu \rightarrow e\gamma)} = \frac{(U_{e1} U_{\tau 1}^* m_1 + U_{e2} U_{\tau 2}^* m_2)}{(U_{e1} U_{\mu 1}^* m_1 + U_{e2} U_{\mu 2}^* m_2)}, \quad \frac{\text{Br}(\tau \rightarrow \mu\gamma)}{\text{Br}(\mu \rightarrow e\gamma)} = \frac{(U_{\mu 1} U_{\tau 1}^* m_1 + U_{\mu 2} U_{\tau 2}^* m_2)}{(U_{e1} U_{\mu 1}^* m_1 + U_{e2} U_{\mu 2}^* m_2)} \quad (30)$$

for inverted hierarchy. Note that, since for the two octet fermion case with real \mathcal{R} there is no additional parameter in the theory apart from the ones measured in low energy experiments, one can get an exact prediction for these ratios of branching ratios in terms of oscillation parameters. Hence, experimental measurement of some or all of them can be used to check if the lepton flavor violation is solely due to the neutrino mass generation mechanism or not. The present bounds are $\text{Br}(\tau \rightarrow \mu\gamma) \leq 4.5 \times 10^{-8}$ and $\text{Br}(\tau \rightarrow e\gamma) \leq 1.2 \times 10^{-7}$, respectively [7]. Disregarding the possibility of cancellations in the numerator or denominator, the above expressions (29) and (30) are expected to be of order one. Since experimentally the limits obey $\text{Br}(\mu \rightarrow e\gamma) \ll \text{Br}(\tau \rightarrow \mu\gamma)$ as well as $\text{Br}(\mu \rightarrow e\gamma) \ll \text{Br}(\tau \rightarrow e\gamma)$, the limits on $\tau \rightarrow \mu\gamma$ and $\tau \rightarrow e\gamma$ are therefore automatically obeyed if the limit on $\mu \rightarrow e\gamma$ is obeyed.

5 Neutrinoless Double Beta Decay with Three Color Octet Fermions

After discussing lepton number and lepton flavor violating processes for two degenerate color octet fermionic states in the last section, we now turn to the three generation scenario, dropping in addition the assumption of degenerate octet fermions. It is evident from Eq. (16) and the discussion following it that in this case the color octet contribution and the light neutrino contribution of $0\nu\beta\beta$ do not share the same proportionality factor M_{ee} anymore. This particular feature brings up the possibility that, even if the light neutrino contribution becomes

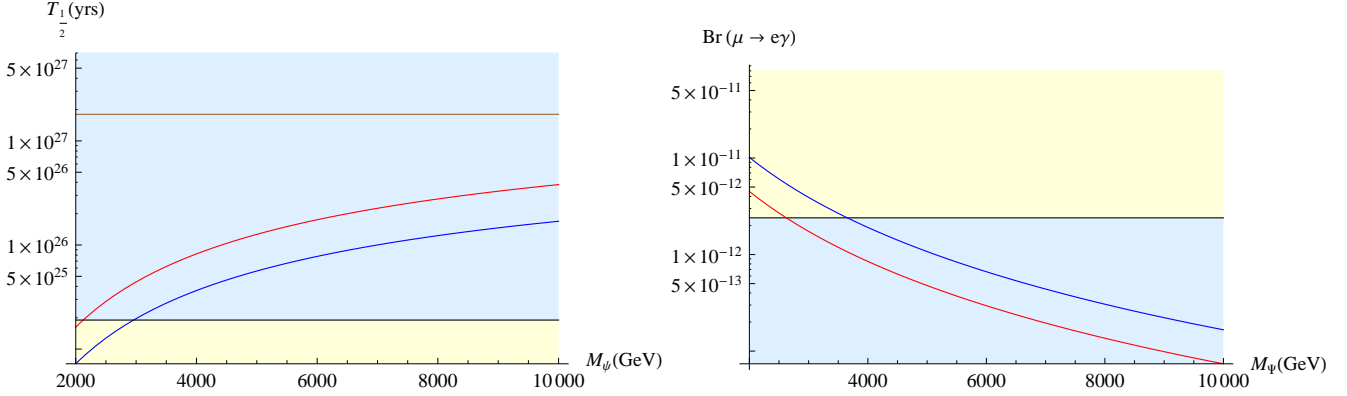

Figure 8: Half-life of $0\nu\beta\beta$ in ^{76}Ge and the branching ratio for $\mu \rightarrow e\gamma$ as a function of the octet fermion mass M_Ψ for inverted hierarchy. The mass of scalar octet has been fixed as $M_\Phi = 1.96$ TeV. The red and blue lines correspond to $\lambda_{\Phi H} = 0.15 \times 10^{-8}$ and $\lambda_{\Phi H} = 0.1 \times 10^{-8}$, respectively. In the left panel the light neutrino contribution has been shown in gray, without any scaling factor. While for the left plot $\tilde{y}_{11}^2 = 0.05$, the right panel is generated without any additional suppression factor. The blue areas are allowed, the yellow ones forbidden.

zero due to cancellation between the terms with m_1 , m_2 and m_3 , the color octet contribution can be non-zero, and even significantly large. We explicitly show this specific feature for one case.

In general, the color octet contribution will have a significant dependence on the phases of the matrix \mathcal{R} . We do not address this issue in the present work, as we will encounter extreme cases even when $\mathcal{R}_{ij} = \delta_{ij}$, in which case the particle physics amplitude of $0\nu\beta\beta$ is given by

$$\mathcal{A} \simeq \frac{16\pi^2}{\lambda_{\Phi H} v^2} \frac{y_{11}^2}{M_\Phi^4} \left(\sum_i \frac{m_i U_{ei}^2}{M_\Psi \mathcal{I}_i} \right). \quad (31)$$

We will stick to this simple case throughout the rest of this section, as very interesting features arise already at this stage.

In what regards neutrino mixing, we try to keep things as simple as possible, and study a somewhat minimal deviation from tri-bimaximal mixing. Denoting $\sin \theta_{13} = \lambda$, the PMNS mixing matrix is now

$$U_{\text{PMNS}} \simeq \begin{pmatrix} -\frac{2}{\sqrt{6}} & \frac{1}{\sqrt{3}} & \lambda e^{-i\delta} \\ \frac{1}{\sqrt{6}} - \frac{\lambda}{\sqrt{3}} e^{i\delta} & \frac{1}{\sqrt{3}} + \frac{\lambda}{\sqrt{6}} e^{i\delta} & -\frac{1}{\sqrt{2}} \\ \frac{1}{\sqrt{6}} + \frac{\lambda}{\sqrt{6}} e^{i\delta} & \frac{1}{\sqrt{3}} - \frac{\lambda}{\sqrt{6}} e^{i\delta} & \frac{1}{\sqrt{2}} \end{pmatrix} \text{diag}(1, e^{i\alpha}, e^{i(\beta+\delta)}). \quad (32)$$

Note that we allow for a complex PMNS matrix in what follows. In this case, the amplitude for the light neutrino contribution to $0\nu\beta\beta$ is

$$\mathcal{A}_l \simeq \frac{G_F^2}{\langle p^2 \rangle} \left(\frac{2m_1}{3} + \frac{m_2}{3} e^{i2\alpha} + m_3 \lambda^2 e^{i2\beta} \right). \quad (33)$$

For the amplitude of $0\nu\beta\beta$ mediated by the color octet fermions and scalars, we have

$$\mathcal{A} \simeq \frac{y_{11}^2}{M_\Phi^4} \frac{16\pi^2}{\lambda_{\Phi H} v^2} \left(\frac{2m_1}{3\mathcal{I}_1 M_{\Psi_1}} + \frac{m_2 e^{i2\alpha}}{3\mathcal{I}_2 M_{\Psi_2}} + \frac{m_3 \lambda^2 e^{i2\beta}}{\mathcal{I}_3 M_{\Psi_3}} \right). \quad (34)$$

The branching ratio for the process $\mu \rightarrow e\gamma$ is given by

$$\text{Br}(\mu \rightarrow e\gamma) \propto \left| (2e^{i\delta} \lambda - \sqrt{2}) \frac{m_1 \mathcal{F}(x_1)}{\mathcal{I}_1} + (\sqrt{2} e^{i2\alpha} + \lambda e^{i2\alpha+i\delta}) \frac{m_2 \mathcal{F}(x_2)}{\mathcal{I}_2} - 3e^{i2\beta+i\delta} \lambda \frac{m_3 \mathcal{F}(x_3)}{\mathcal{I}_3} \right|^2, \quad (35)$$

where the proportionality factor is $\frac{2}{3} \frac{16\pi^3}{\lambda_{\Phi H}^2 v^4} \frac{\alpha_{\text{em}}}{G_F^2 M_\Phi^4}$.

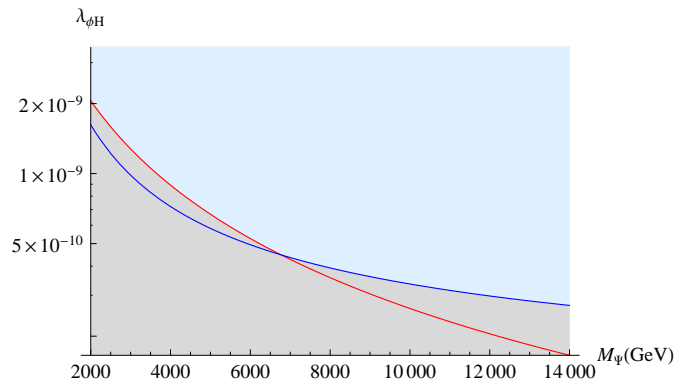

Figure 9: The coupling $\lambda_{\Phi H}$ against the mass of the color octet fermions M_Ψ for inverted hierarchy. The gray band is experimentally excluded by $\mu \rightarrow e\gamma$ and $0\nu\beta\beta$. The mass of scalar octet has been fixed as $M_\Phi = 1.96$ TeV. The red and blue lines represent the saturating contribution in MEG experiment and Heidelberg–Moscow bound. The factor \tilde{y}_{11}^2 has been set to 0.05.

Focussing on the ratio between \mathcal{A} and \mathcal{A}_l , and therefore on the relative size of the direct and indirect contributions to $0\nu\beta\beta$, see Fig. 10. We have plotted there for the normal and inverted mass ordering the ratio of the amplitudes as a function of the smallest neutrino mass for different values of $\lambda_{\Phi H}$. It is obvious that even for this simple example that the ratio of the amplitude can be very large or very small, corresponding to the dominance of one of the contributions. The details of the figure are as follows:

- The mass of the color octet scalar M_Φ has been set to 2 TeV, while the masses of the color octet fermions M_{Ψ_i} have been varied inside the interval $[0.9, 1.1]$ TeV. No particular form of hierarchy has been considered between the color octet fermions. The random variation inside this interval mainly assures that there is no exact degeneracy between the three fermions.
- The Yukawa coupling y_{11} has been varied inside the interval $[0.001, 1.0]$. Additionally, all phases in the PMNS matrix have been varied in the interval $[0, 2\pi]$.
- The solar and atmospheric mass-squared differences, as well as θ_{13} have been varied inside their presently allowed 3σ intervals [35]. The typical momentum scale has been set to $\langle p^2 \rangle \simeq (100)^2 \text{ MeV}^2$.
- The differently colored regions in this figure correspond to different $\lambda_{\Phi H}$ values as shown, all satisfying the MEG limit $\text{Br}(\mu \rightarrow e\gamma) < 2.4 \times 10^{-12}$.
- Note that as $\lambda_{\Phi H}$ increases, the ratio $\mathcal{A}/\mathcal{A}_l$ decreases. The large increase in $\mathcal{A}/\mathcal{A}_l$ for low values of m_1 in normal hierarchy is an artifact of phase cancellation in \mathcal{A}_l .

Another illustrative way to visualize the different contributions is to define an “effective mass” for the direct octet contribution. Noting that from the indirect amplitude the usual effective mass M_{ee} [36, 37] is obtained by multiplying \mathcal{A}_l with $\langle p^2 \rangle / G_F^2$, we can define the “color effective mass” as $\frac{\langle p^2 \rangle}{G_F^2} \mathcal{A}$, where \mathcal{A} is given in Eq. (34).

We can plot now both the standard effective mass M_{ee} and its analogous expression $\frac{\langle p^2 \rangle}{G_F^2} \mathcal{A}$ as a function of the lightest neutrino mass eigenvalue. The two plots are given in Fig. 11. We see that the usual phenomenology can be significantly modified. For instance, in the inverted hierarchy (negligible m_3) one expects in the standard case $M_{ee} \gtrsim 0.05$ eV. The direct contribution from the octets does approach 1 eV, and hence (for the simple example considered here), can be used to cut in the parameter space of couplings and masses. Note also that the predicted $0\nu\beta\beta$ is very large even for normal hierarchy and almost comparable to that for inverted hierarchy, as pointed out earlier for the two octet case.

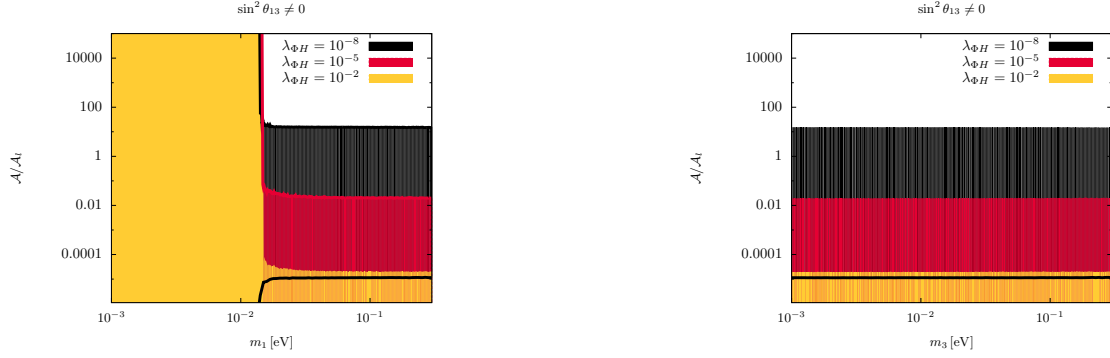

Figure 10: The ratio of particle physics amplitudes for normal hierarchy (left panel) and inverted hierarchy (right panel) as a function of the lightest neutrino mass for non-zero $\sin^2 \theta_{13}$ [34]. The parameters used are given in the text. The colored areas give the allowed regions using the current MEG limit for $\mu \rightarrow e\gamma$. Recall that the standard effective mass, or \mathcal{A}_l , is observable in the next few years for values of $m_1 \gtrsim 0.3$ eV. The black and red lines give the upper or lower values of the correspondingly colored areas. Note that the areas for different values of $\lambda_{\Phi H}$ overlap. The lower red and yellow lines are below the scale of the axis.

6 Final Remarks and Conclusions

There are two issues regarding our framework which we now address. The first one deals with dropping the MFV hypothesis. Strong constraints on FCNC processes exist, for example from scalar color octet exchange in $K^0-\bar{K}^0$ mixing, from $b \rightarrow s\gamma$ or the electric dipole moment of the neutron, see e.g. Ref. [33]. We note that the octet contribution to neutrinoless double decay that we consider in this work depends only on the coupling of the scalar octet Φ with an up- and a down-quark. One can convince oneself that in all possible FCNC diagrams this coupling never appears on its own. For instance, in $K^0-\bar{K}^0$ mixing diagrams or in $b \rightarrow s\gamma$ it appears together with couplings involving 2nd and 3rd generation quarks. Constraints coming from the electric dipole moment of the neutron can be avoided by setting a possible phase to small values (in analogy to the SUSY CP problem). While this is not a completely satisfying situation, we nevertheless note that in the limit of only the coupling to up- and a down-quarks being non-zero, we face no phenomenological problem. In addition, neutrinoless double decay is the only place in which that coupling appears on its own and hence it is the only place where it can directly be constrained.

Another point is the strong hierarchy between $\lambda_{\Phi H}$ and the Yukawa coupling of up- and down quarks. Radiative corrections might spoil this hierarchy, for instance one might have diagrams in which the quartic $\Phi^\dagger \Phi^\dagger H H$ coupling is mediated by quark loops. However, in the same limit as above, namely only the coupling of Φ to up- and a down-quarks being non-zero, this diagram is suppressed heavily by $(m_{u,d}/v)^2$ and causes no problem.

To sum up, in this work we have discussed neutrinoless double beta decay and lepton flavor violation in $\mu \rightarrow e\gamma$ for the so-called colored seesaw scenario. In this model, the color octet scalars and fermions generate Majorana masses for the light neutrinos via one-loop diagrams. Since these states have non-trivial charge under $SU(3)_c$ and the electroweak gauge group, the same set of fields can directly participate in neutrinoless double beta decay and lepton flavor violating processes.

Studying only simple examples, we have already found interesting features: it is for instance possible that the octet states saturate the limits on both $\mu \rightarrow e\gamma$ and neutrinoless double beta decay. If the octet fermions are degenerate in mass, then the contributions to $0\nu\beta\beta$ from the octets and the light neutrinos are both proportional to the effective mass M_{ee} , their relative importance depending on the model parameters.

It is conceptually interesting that the color octets imply a direct and an indirect contribution to neutrinoless double beta decay: the direct contribution is the one considered here for the first time, namely the short-range exchange of octet scalars and fermions. The indirect contribution is the standard, long-range one with the exchange of light Majorana neutrinos. These neutrinos are generated at loop-level by the octets and it is interesting to compare those two contributions. Extreme cases are easily possible, in the sense that both contributions can be

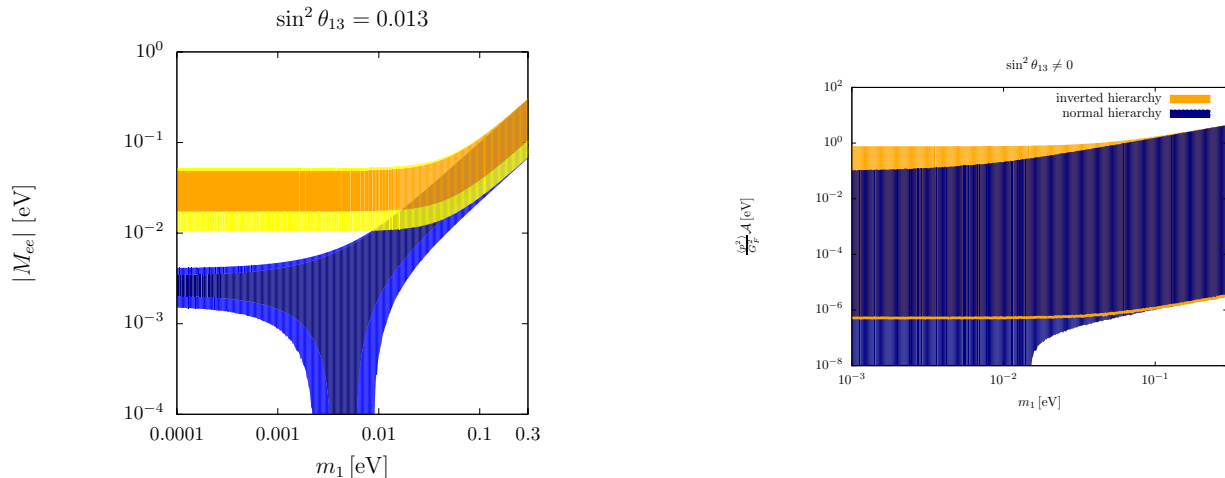

Figure 11: Left: the usual plot [36] of the effective mass against the smallest neutrino mass. Right: the “color effective mass” $\frac{\langle p^2 \rangle}{G_F^2} \mathcal{A}$, which has to be compared with the effective mass in the standard diagram for $0\nu\beta\beta$, as a function of the lightest neutrino mass. For the right plot, $\lambda_{\Phi H} = 10^{-8}$. The normal ordering is given in blue and the inverted ordering in yellow. The darker areas are valid when the oscillation parameters are fixed to their best-fit values (for better visibility only best-fit values for the octet contribution are given), the brighter areas for the 3σ ranges, and $\sin \theta_{13}$ has been fixed to 0.013. In the right plot, the lower yellow line gives the minimum value for inverted hierarchy. Recall that the standard effective mass M_{ee} is observable in the next few years for values of $m_1 \gtrsim 0.3$ eV, and the current limit on the half-life corresponds to about 1 eV for M_{ee} , which roughly is also the limit for $\frac{\langle p^2 \rangle}{G_F^2} \mathcal{A}$.

either dominant or negligible.

Acknowledgments

MM would like to thank Francesco Vissani for carefully reading the manuscript and for his very useful comments. MD and WR would like to thank Adisorn Adulpravitchai for collaboration at an early stage. MD is supported by the IMPRS-PTFS, WR by the ERC under the Starting Grant MANITOP and by the Deutsche Forschungsgemeinschaft in the Transregio 27. WR and SC acknowledge support from the Indo-German DST-DFG program RO 2516/4-1. SC acknowledges support from the Neutrino Project under the XIth plan of Harish-Chandra Research Institute.

References

- [1] S. M. Bilenky, S. T. Petcov, Rev. Mod. Phys. **59**, 671 (1987); M. C. Gonzalez-Garcia, Y. Nir, Rev. Mod. Phys. **75**, 345-402 (2003) [arXiv:hep-ph/0202058]. R. N. Mohapatra, A. Y. Smirnov, Ann. Rev. Nucl. Part. Sci. **56** (2006) 569-628 [arXiv:hep-ph/0603118]; A. Strumia and F. Vissani, arXiv:hep-ph/0606054; G. Senjanović, Riv. Nuovo Cim. **034** (2011) 1-68.
- [2] H. V. Klapdor-Kleingrothaus, A. Dietz, L. Baudis, G. Heusser, I. V. Krivosheina, S. Kolb, B. Majorovits, H. Pas *et al.*, Eur. Phys. J. **A12** (2001) 147-154 [arXiv:hep-ph/0103062].
- [3] C. Arnaboldi *et al.* [CUORICINO Collaboration], Phys. Rev. **C78**, 035502 (2008) [arXiv:0802.3439 [hep-ex]]. J. Argyriades *et al.* [NEMO Collaboration], Phys. Rev. **C80**, 032501 (2009) [arXiv:0810.0248 [hep-ex]].

- [4] I. Abt, M. F. Altmann, A. Bakalyarov, I. Barabanov, C. Bauer, E. Bellotti, S. T. Belyaev, L. B. Bezrukov *et al.*, [arXiv:hep-ex/0404039]; S. Schonert *et al.* [GERDA Collaboration], Nucl. Phys. Proc. Suppl. **145**, 242-245 (2005).
- [5] C. Arnaboldi *et al.* [CUORE Collaboration], Nucl. Instrum. Meth. **A518**, 775-798 (2004) [arXiv:hep-ex/0212053].
- [6] J. Adam *et al.* [MEG Collaboration], Phys. Rev. Lett. **107**, 171801 (2011) [arXiv:1107.5547 [hep-ex]].
- [7] K. Hayasaka *et al.* [Belle Collaboration], Phys. Lett. B **666**, 16 (2008) [arXiv:0705.0650 [hep-ex]].
- [8] R. Arnold *et al.* [SuperNEMO Collaboration], Eur. Phys. J. **C70**, 927-943 (2010) [arXiv:1005.1241 [hep-ex]]; V. E. Guiseppe *et al.* [Majorana Collaboration], IEEE Nucl. Sci. Symp. Conf. Rec. **2008** (2008) 1793 [arXiv:0811.2446 [nucl-ex]]. F. Ferroni, J. Phys. Conf. Ser. **293**, 012005 (2011) J. W. Beeman, F. Bellini, L. Cardani, N. Casali, I. Dafinei, S. Di Domizio, F. Ferroni and F. Orio *et al.*, Astropart. Phys. **35** (2012) 558 [arXiv:1106.6286 [physics.ins-det]].
- [9] G. Racah, Nuovo Cim. **14**, 322-328 (1937); W. H. Furry, Phys. Rev. **56**, 1184-1193 (1939).
- [10] G. Feinberg, M. Goldhaber, Proc. Nat. Ac. Sci. USA **45**, 1301 (1959); B. Pontecorvo, Phys. Lett. **B26**, 630-632 (1968).
- [11] R. N. Mohapatra, Phys. Rev. **D34**, 3457-3461 (1986).
- [12] K. S. Babu, R. N. Mohapatra, Phys. Rev. Lett. **75**, 2276-2279 (1995) [arXiv:hep-ph/9506354].
- [13] J. D. Vergados, Phys. Rev. D **25**, 914 917 (1982); S. Bergmann, H. V. Klapdor-Kleingrothaus, H. Pas, Phys. Rev. **D62**, 113002 (2000) [arXiv:hep-ph/0004048]; A. Faessler, T. Gutsche, S. Kovalenko, F. Simkovic, Phys. Rev. **D77**, 113012 (2008) [arXiv:0710.3199 [hep-ph]].
- [14] M. Hirsch, H. V. Klapdor-Kleingrothaus, S. G. Kovalenko, Phys. Lett. **B352**, 1-7 (1995) [arXiv:hep-ph/9502315]; M. Hirsch, H. V. Klapdor-Kleingrothaus, S. G. Kovalenko, Phys. Rev. **D53**, 1329-1348 (1996) [arXiv:hep-ph/9502385]; M. Hirsch, H. V. Klapdor-Kleingrothaus, S. G. Kovalenko, Phys. Rev. **D54**, 4207-4210 (1996) [arXiv:hep-ph/9603213]; M. Hirsch, H. V. Klapdor-Kleingrothaus, S. G. Kovalenko, Phys. Rev. **D57**, 1947-1961 (1998) [arXiv:hep-ph/9707207]; M. Hirsch, J. W. F. Valle, Nucl. Phys. **B557**, 60-78 (1999) [arXiv:hep-ph/9812463].
- [15] B. C. Allanach, C. H. Kom, H. Pas, Phys. Rev. Lett. **103**, 091801 (2009) [arXiv:0902.4697 [hep-ph]].
- [16] V. Cirigliano, A. Kurylov, M. J. Ramsey-Musolf, P. Vogel, Phys. Rev. **D70**, 075007 (2004) [arXiv:hep-ph/0404233]; V. Cirigliano, A. Kurylov, M. J. Ramsey-Musolf, P. Vogel, Phys. Rev. Lett. **93**, 231802 (2004) [arXiv:hep-ph/0406199].
- [17] K. W. Choi, K. S. Jeong, W. Y. Song, Phys. Rev. **D66**, 093007 (2002) [arXiv:hep-ph/0207180].
- [18] V. Tello, M. Nemevšek, F. Nesti, G. Senjanović, F. Vissani, Phys. Rev. Lett. **106**, 151801 (2011) [arXiv:1011.3522 [hep-ph]]; M. Nemevsek, F. Nesti, G. Senjanovic and V. Tello, arXiv:1112.3061 [hep-ph].
- [19] A. Ibarra, E. Molinaro, S. T. Petcov, JHEP **1009**, 108 (2010) [arXiv:1007.2378 [hep-ph]]; A. Ibarra, E. Molinaro, S. T. Petcov, [arXiv:1101.5778 [hep-ph]].
- [20] M. Blennow, E. Fernandez-Martinez, J. Lopez-Pavon, J. Menendez, JHEP **1007** (2010) 096 [arXiv:1005.3240 [hep-ph]].
- [21] M. Mitra, G. Senjanovic and F. Vissani, Nucl. Phys. B **856**, 26 (2012) [arXiv:1108.0004 [hep-ph]].
- [22] F. del Aguila, A. Aparici, S. Bhattacharya, A. Santamaria and J. Wudka, arXiv:1111.6960 [hep-ph].

- [23] W. Rodejohann, *Int. J. Mod. Phys. E* **20** (2011) 1833 [arXiv:1106.1334 [hep-ph]].
- [24] J. J. Gomez-Cadenas, J. Martin-Albo, M. Mezzetto, F. Monrabal and M. Sorel, *Riv. Nuovo Cim.* **35** (2012) 29 [arXiv:1109.5515 [hep-ex]].
- [25] P. Minkowski, *Phys. Lett.* **B67**, 421 (1977). R. N. Mohapatra, G. Senjanović, *Phys. Rev. Lett.* **44**, 912 (1980). T. T. Yanagida, in *Proceedings of the Workshop on the Unified Theory and the Baryon Number in the Universe* (O. Sawada and A. Sugamoto, eds.), KEK, Tsukuba, Japan, 1979, p.95. M. Gell-Mann, P. Ramond, R. Slansky, *Supergravity* (P. van Nieuwenhuizen *et al.*, eds.), North Holland, Amsterdam, 1980.
- [26] P. Fileviez Perez and M. B. Wise, *Phys. Rev. D* **80** (2009) 053006 [arXiv:0906.2950 [hep-ph]].
- [27] P. Fileviez Perez, T. Han, S. Spinner and M. K. Trenkel, *JHEP* **1101** (2011) 046 [arXiv:1010.5802 [hep-ph]].
- [28] Y. Liao and J. Y. Liu, *Phys. Rev. D* **81** (2010) 013004 [arXiv:0911.3711 [hep-ph]].
- [29] S. Weinberg, *Phys. Rev. Lett.* **43**, 1566-1570 (1979); F. Wilczek, A. Zee, *Phys. Rev. Lett.* **43**, 1571-1573 (1979).
- [30] J. A. Casas, A. Ibarra, *Nucl. Phys.* **B618**, 171-204 (2001) [arXiv:hep-ph/0103065].
- [31] G. Aad *et al.* [ATLAS Collaboration], *Phys. Lett. B* **708** (2012) 37 [arXiv:1108.6311 [hep-ex]].
- [32] G. Aad *et al.* [ATLAS Collaboration], arXiv:1109.6572 [hep-ex].
- [33] A. V. Manohar and M. B. Wise, *Phys. Rev. D* **74** (2006) 035009 [arXiv:hep-ph/0606172].
- [34] K. Abe *et al.* [T2K Collaboration], *Phys. Rev. Lett.* **107** (2011) 041801 [arXiv:1106.2822 [hep-ex]].
- [35] T. Schwetz, M. A. Tortola and J. W. F. Valle, *New J. Phys.* **10** (2008) 113011 [arXiv:0808.2016 [hep-ph]].
- [36] F. Vissani, *JHEP* **9906**, 022 (1999) [arXiv:hep-ph/9906525].
- [37] F. Feruglio, A. Strumia and F. Vissani, *Nucl. Phys. B* **637**, 345 (2002) [Addendum-ibid. *B* **659**, 359 (2003)] [arXiv:hep-ph/0201291]; A. Strumia and F. Vissani, *Nucl. Phys. B* **726**, 294 (2005) [arXiv:hep-ph/0503246].