

Graphical Methods for Tannaka Duality of Weak Bialgebras and Weak Hopf Algebras in Arbitrary Braided Monoidal Categories

Micah Blake McCurdy*

12 October 2011

Abstract

Tannaka Duality describes the relationship between algebraic objects in a given category and their representations; an important case is that of Hopf algebras and their categories of representations; these have strong monoidal forgetful “fibre functors” to the category of vector spaces. We simultaneously generalize the theory of Tannaka duality in two ways: first, we replace Hopf algebras with *weak Hopf algebras* and strong monoidal functors with *separable Frobenius monoidal functors*; second, we replace the category of vector spaces with an arbitrary braided monoidal category. To accomplish this goal, we introduce a new graphical notation for functors between monoidal categories, using string diagrams with *coloured regions*. Not only does this notation extend our capacity to give simple proofs of complicated calculations, it makes plain some of the connections between Frobenius monoidal or separable Frobenius monoidal functors and the topology of the axioms defining certain algebraic structures. Finally, having generalized Tannaka to an arbitrary base category, we briefly discuss the functoriality of the construction as this base is varied.

1 Introduction

Broadly speaking, Tannaka duality describes the relationship between algebraic objects and their representations; for an excellent introduction, see the survey of Joyal and Street [JS91]. On the one hand, given an algebraic object H in a monoidal category \mathcal{V} (for instance, a Hopf algebra in the category \mathbf{Vec}_k of vector spaces over a field k), one can consider the functor which takes the algebraic object to its category of representations, $H\text{-mod}$, equipped with its canonical forgetful functor back to \mathcal{V} . This process is *representation* and it can be defined in a great variety of situations, with very mild assumptions on \mathcal{V} .

On the other hand, given a suitable functor $F: A \rightarrow \mathcal{V}$, we can try to use the properties of F (which of course include those of A and \mathcal{V}) to build an algebraic object in \mathcal{V} ; this is what we call *the Tannaka construction*. Historically, the algebraic objects have been considered primitive, and this process was called “reconstruction”; but since it can be considered as an independent question, we discard the prefix “re-”.

The classical paper of Tannaka [Tan38] describes the reconstruction of a compact group from its representations, and is the starting point for the theory which bears his name. Crucially, for a given algebraic object, the forgetful functor from its category of representations to \mathbf{Vec}_k is considered the starting point for the project of reconstruction—such functors are known as “fibre functors”.

Reconstruction requires more stringent assumptions on F —certainly \mathcal{V} must be braided; objects in the image of F must have duals; and \mathcal{V} must admit certain ends or coends which cohere with the monoidal structure.

In this paper, we show that the theory of Tannaka duality can be extended to an adjunction between a suitable category of *separable Frobenius monoidal functors* into an arbitrary base category \mathcal{V} and a suitable category of *weak bialgebras* in \mathcal{V} . We describe the restriction of this adjunction to *weak Hopf*

*Saint Mary’s University. Partially supported by a Macquarie University Research Excellence Scholarship (MQRES). This work is substantially the same as parts of the third chapter of the author’s Macquarie University Doctoral Thesis, “Cyclic Star-autonomous Categories and the Tannaka Construction via Graphical Methods”, completed July 2011

algebras; and we show that our constructions coincide with the existing theory of Tannaka duality where applicable. In a sequel [McC] to the present paper, we will show that this theory can be refined to include various sorts of structured weak bialgebras and their correspondingly structured (generalized) fibre functors.

1.1 Existing work

Many people have devoted considerable effort to various versions of the Tannaka construction, at various levels of generality. Mostly, attention has been confined to fibre functors which are *strong monoidal* and which have codomain $\mathcal{V} = \mathbf{Vec}_k$. A landmark paper is that of Ulbrich [Ulbr90], who showed that one can obtain a Hopf algebra from a strong monoidal functor $A \rightarrow \mathbf{Vec}_k$, where A is an autonomous-but-not-necessarily-symmetric monoidal category. The case of not-necessarily-coherent strong monoidal functors into \mathbf{Vec}_k has been shown by Majid [Maj92] to result in a quasi-Hopf algebra in the sense of Drinfeld [Dri89] this was extended by Häring [HO97] to cover the case of not-necessary-coherent weak monoidal functors into \mathbf{Vec}_k . The reader should note that the sense of “weak” Hopf algebra in [HO97] is slightly different from that of Böhm, Nill, and Szlachányi [BNS99] (whom we follow here); but the core idea is the same—namely, that “weak” Hopf algebras should be bialgebras in which the unit is not strictly grouplike.

The generalization of the Tannaka construction to an arbitrary base category \mathcal{V} (instead of merely \mathbf{Vec}_k) was done by Schauenburg [Sch92], followed slightly later by Majid [Maj93]. A more abstract approach to the Tannaka construction, still using strong monoidal fibre functors, was initiated by Day [Day96], who considered the case of \mathcal{V} a suitable enriched category. This abstract line of thinking was extended by McCrudden in [McC00] and [McC02] and more recently by Schächli [Sch09].

However, for our purposes, the most closely related existing work is that of Szlachányi [Szl05], who discusses separable Frobenius monoidal functors into $\mathcal{V} = \mathbf{Mod}_R$, for R a commutative ring. On the one hand, our work is slightly more general in certain aspects—for instance, we work with braided \mathcal{V} , whereas \mathbf{Mod}_R is symmetric. However, the treatment in [Szl05] is much more sophisticated than the approach of the present paper, taking in, as it does, the more general notion of algebroids as well as tackling the Krein recognition problem, which we do not discuss. Finally, Pfeiffer [Pfe09] has shown that every *modular* category admits a generalized fibre functor into the field of endomorphisms of its tensor unit; this functor is separable Frobenius monoidal and he shows that the Tannaka construction makes it into a weak Hopf algebra of a particular type.

1.2 Structure

In Section 2, we rehearse the basic algebraic notions of bialgebras, weak bialgebras, Hopf algebras, and weak Hopf algebras, together with the string diagrams which will be used throughout. In Section 3, we introduce our new graphical language for functors between monoidal categories which will be the key technical tool for all of our proofs. In Section 4, we define the Tannaka construction for separable Frobenius monoidal functors, obtaining weak bialgebras and weak Hopf algebras. In Section 5, we recall the representation theory of weak bialgebras and weak Hopf algebras. In Section 6, we show that these constructions form an adjunction where the Tannaka construction is left adjoint to representation. Finally, in Section 7, we consider varying the base category through a suitable 2-category of braided monoidal categories.

2 Graphical Notation for Algebraic Objects

We make extensive use of the now-standard string diagram calculus for depicting morphisms in monoidal categories. Our convention is to depict composition from left-to-right and to depict the tensor product

from top-to-bottom; so for instance we depict a composite $a \otimes b \xrightarrow{f} c \xrightarrow{g} d \otimes e$ as:

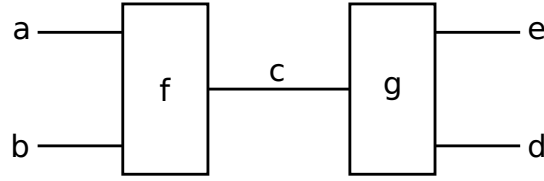

2.1 Basic Notions

We recall the notions of *weak bialgebra* and *weak Hopf algebra*, to fix notation.

Definition 1 (Algebras). An *algebra* or *monoid* H in a monoidal category \mathcal{V} is an object H equipped with a unit $\eta: \top \rightarrow H$ and a multiplication $\mu: H \otimes H \rightarrow H$, which must be associative and unital:

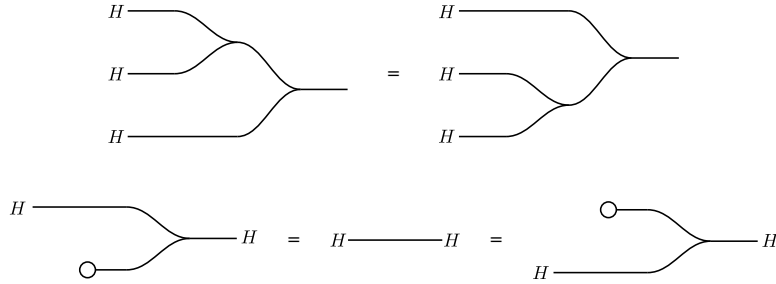

Definition 2 (Coalgebras). Dually, a *coalgebra* or *comonoid* C is an object C of \mathcal{V} equipped with a counit $\epsilon: C \rightarrow \top$ and a comultiplication $\Delta: C \rightarrow C \otimes C$ and which must be coassociative and counital:

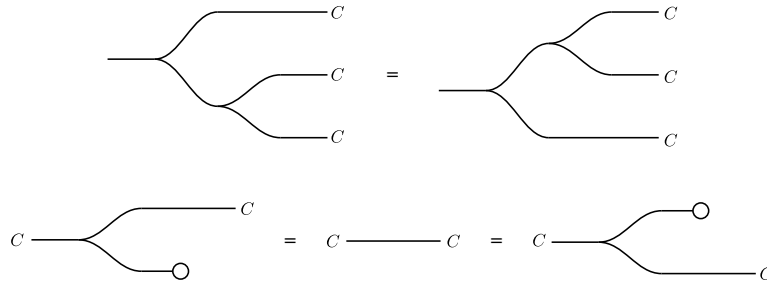

Definition 3 (Convolution). If (A, μ, η) is an algebra in a monoidal category \mathcal{V} , and (C, Δ, ϵ) a coalgebra, then the set of arrows $\mathcal{V}(A, C)$ bears a canonical monoid structure, known as *convolution*, defined by:

$$f \star g = \mu(f \otimes g)\Delta$$

The neutral element for \star is given by $\eta\epsilon$.

We can consider an object H which is both an algebra and a coalgebra at once, and we can ask these two structures to cohere in various different ways. For the moment we consider four such ways:

2.1.1 Frobenius Algebras

Definition 4 (Frobenius Algebras). An object H equipped with both an algebra and a coalgebra structure is said to be a *Frobenius algebra* if it satisfies:

$$(H \otimes \mu)(\Delta \otimes H) = \Delta\mu = (\mu \otimes H)(H \otimes \Delta)$$

That is:

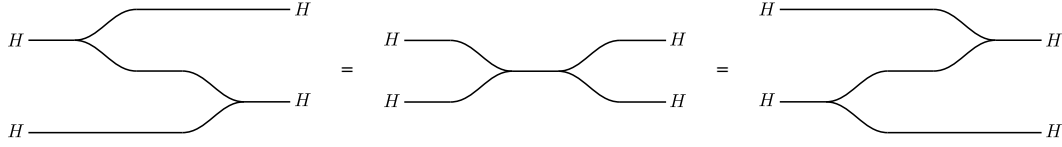

A Frobenius algebra for which $\mu\Delta = H$ is said to be *separable*:

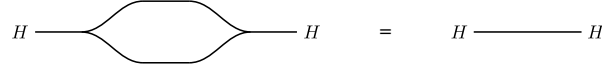

Note that the separability equation is precisely the assertion that the identity $H: H \rightarrow H$ is a convolution idempotent $H \star H = H$.

2.1.2 Bialgebras

Definition 5 (The Barbell). Suppose that H is an object in a monoidal category, equipped with an algebra structure (μ, η) and a coalgebra structure (Δ, ϵ) . We call the composite $\epsilon\eta$ the *barbell*, because of its depiction: $\circ \text{---} \circ$

Definition 6. An object in a braided category bearing an algebra and coalgebra structure is said to be a *bialgebra* if it satisfies the following four axioms:

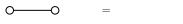
The Barbell Axiom:  (1)

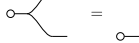
The (Strong) Unit Axiom:  (2)

The (Strong) Counit Axiom:  (3)

The Bialgebra Axiom:  (4)

Note that the empty space on the right-hand side of the Barbell axiom depicts the identity on the tensor unit $\top: \top \rightarrow \top$.

Definition 7. Let H and J be bialgebras in a braided monoidal category \mathcal{V} . Define a (*non-weak*) *morphism of bialgebras* from H to J to be an arrow from H to J which commutes strictly with the multiplication, unit, comultiplication, and counit. In this way we obtain a category of bialgebras in \mathcal{V} which we denote $\mathbf{ba} \mathcal{V}$.

2.1.3 Weak Bialgebras

To move from a non-weak bialgebra to a weak bialgebra, we retain only the Bialgebra Axiom, replacing the other three axioms with weaker versions.

Definition 8 (Weak Bialgebras). An object in a braided category bearing an algebra and coalgebra structure is said to be a *weak bialgebra* if it satisfies:

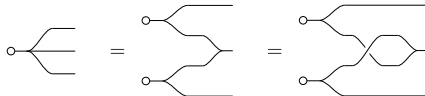
The Weak Unit Axioms:  (5)

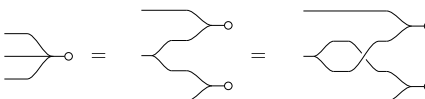
The Weak Counit Axioms:  (6)

The Bialgebra Axiom:  (7)

Note that the braiding which occurs in the Weak Unit and Weak Counit Axioms is the inverse of the one which appears in the Bialgebra Axiom.

The notion of weak bialgebra was introduced by Böhm, Nill, and Szlachányi [BNS99], but see also the treatment of Pastro and Street [PS09]

We defer discussion of morphisms of weak bialgebra until Section 5.1.

Definition 9. An element $c: \top \rightarrow H$ of a bialgebra is said to be *grouplike* if $\Delta c = c \otimes c$.

Definition 10. An element $c: \top \rightarrow H$ of a weak bialgebra H is said to be *almost grouplike* if $\Delta c = (\Delta\eta) \star (c \otimes c) = (c \otimes c) \star (\Delta\eta)$

Note that, if the weak bialgebra H is in fact non-weak, then $(\Delta\eta) \star c \otimes c = (\eta \otimes \eta) \star (c \otimes c) = c \otimes c$, and the almost grouplike elements of H are, in fact, grouplike. In a bialgebra, the unit is grouplike by hypothesis, but it is *not* grouplike in a weak bialgebra, merely almost grouplike. Intuitively, we think of almost grouplike elements in a weak bialgebra as those elements which are “as grouplike as the unit is”.

Observation 1. The monoidal unit \top bears a canonical (trivial) algebra structure, as well as a trivial coalgebra structure. Since \mathcal{V} is braided, every tensor power of an algebra bears a canonical induced algebra structure; similarly, tensor powers of coalgebras are naturally also coalgebras. Hence, we have another way of looking at the unit axioms for weak and non-weak bialgebras. As an algebra, $H \otimes H$ has two distinguished elements, namely, $\eta \otimes \eta$ and $\Delta\eta$. In a non-weak bialgebra, we demand that these two be equal, but we resist making this demand for a weak bialgebra. If H is a weak bialgebra, then there are four distinguished elements of $H \otimes H \otimes H$, namely:

$$\eta \otimes \eta \otimes \eta \quad \Delta\eta \otimes \eta \quad \eta \otimes \Delta\eta \quad \Delta_3\eta$$

where Δ_3 is the common value of $(\Delta \otimes H)\Delta = (H \otimes \Delta)\Delta$. Insisting that these four distinguished elements should be equal is much too strong, instead, the weak unit axioms amount to the following:

$$(\Delta\eta \otimes \eta) \star (\eta \otimes \Delta\eta) = \Delta_3\eta = (\eta \otimes \Delta\eta) \star (\Delta\eta \otimes \eta)$$

Similarly, the weak counit axioms can be given as:

$$(\epsilon\mu \otimes \epsilon) \star (\epsilon \otimes \epsilon\mu) = \epsilon\mu_3 = (\epsilon \otimes \epsilon\mu) \star (\epsilon\mu \otimes \epsilon)$$

Written in this form, as in the graphical form, the duality between the weak unit and weak counit axioms is apparent. In the usual Sweedler notation for weak bialgebras in \mathbf{Vec}_k (where we adopt the conventional $\eta = 1$), these identities appear as $1_1 \otimes 1_2 1_{1'} \otimes 1_{2'} = 1_1 \otimes 1_2 \otimes 1_3 = 1_1 \otimes 1_{1'} 1_2 \otimes 1_{2'}$ and $\epsilon(ab_1)\epsilon(b_2c) = \epsilon(abc) = \epsilon(ab_2)\epsilon(b_1c)$, and the duality is obfuscated.

2.2 The Canonical Idempotents on a Weak Bialgebra

Definition 11. There are four canonical idempotents on a weak bialgebra, namely:

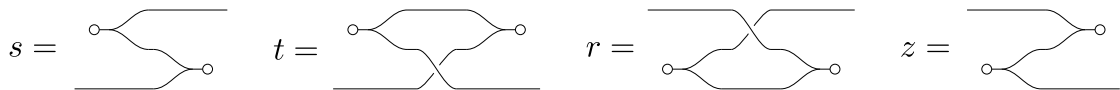

Checking that they are idempotents is an exercise in applying the weak unit and weak counit axioms.

Definition 12. Let C be a category. The *idempotent-splitting completion* or *Cauchy completion* or *Karoubi envelope* of C is written as QC . It is defined as having objects pairs (A, a) , where $a: A \rightarrow A$ is an idempotent in C , and morphisms $f: (A, a) \rightarrow (B, b)$, where $f: A \rightarrow B$ is a morphism in C such that $bfa = f$. Note that the identity on (A, a) is the morphism $a: A \rightarrow A$, not the identity on A .

Proposition 1. Let H be a weak bialgebra in a monoidal category \mathcal{V} . As objects in $Q\mathcal{V}$, all four canonical idempotents on H are isomorphic.

Proof. The four maps:

$$(H, s) \xrightarrow{t} (H, t) \xrightarrow{z} (H, z) \xrightarrow{r} (H, r) \xrightarrow{s} (H, s)$$

are isomorphisms in $Q\mathcal{V}$ with inverses

$$(H, s) \xleftarrow{s} (H, t) \xleftarrow{z} (H, z) \xleftarrow{r} (H, r) \xleftarrow{s} (H, s)$$

which may be readily checked by the reader. □

notation. However, a small alteration improves the notation considerably. For a monoidal structure on a functor $f: A \rightarrow B$, we have a natural family of maps: $\varphi: fx \otimes fy \rightarrow f(x \otimes y)$ and a map $\varphi_0: \top \rightarrow f\top$, which we notate as follows:



Similarly, for a comonoidal structure on f , we have maps $\psi: f(x \otimes y) \rightarrow fx \otimes fy$ and $\psi_0: f\top \rightarrow \top$ which we notate in the obvious dual way, as follows:



Note that the functor symbol “ f ” does *not* appear in the wire labels; after all, its red color identifies it. Furthermore, the tensor unit \top is suppressed, as usual. Finally, notice that the naturality of the binary monoidal or comonoidal structure is made obvious by the depiction of the wires labelled “ x ” or “ y ” passing unperturbed from left to right.

The structural maps for a monoidal functor are required to be associative:

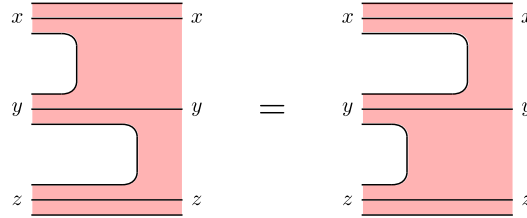

and unital:

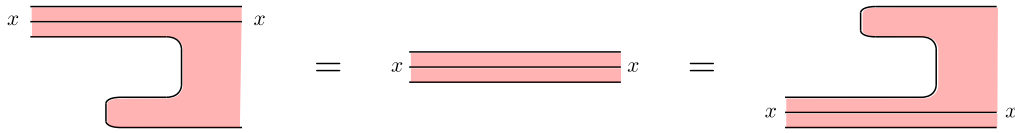

where, once again, the corresponding constraints for a comonoidal functor are exactly the above with composition read right-to-left instead of left-to-right. Note that flipping these axioms vertically leaves them unchanged.

The above axioms seem to indicate some sort of “invariance under continuous deformation of functor-regions”. For a functor which is both monoidal and comonoidal, pursuing this line of thinking leads one to consider the following pair of axioms:

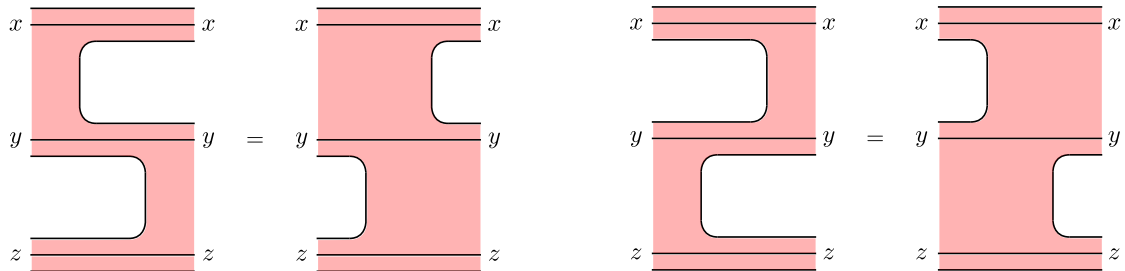

Or, in pasting diagrams:

$$\begin{array}{ccc}
 & f(x \otimes y) \otimes fz & \\
 \psi \otimes fz \swarrow & & \searrow \varphi \\
 (fx \otimes fy) \otimes fz & & f((x \otimes y) \otimes z) \\
 \delta \downarrow & & \downarrow f\delta \\
 fx \otimes (fy \otimes fz) & & f(x \otimes (y \otimes z)) \\
 fx \otimes \varphi \swarrow & & \searrow \psi \\
 & fx \otimes f(y \otimes fz) &
 \end{array}
 \qquad
 \begin{array}{ccc}
 & fx \otimes f(y \otimes z) & \\
 fx \otimes \psi \swarrow & & \searrow \varphi \\
 fx \otimes (fy \otimes fz) & & f(x \otimes (y \otimes z)) \\
 \delta \downarrow & & \downarrow f\delta \\
 (fx \otimes fy) \otimes fz & & f((x \otimes y) \otimes z) \\
 \varphi \otimes fz \swarrow & & \searrow \psi \\
 & fx \otimes f(y \otimes fz) &
 \end{array}
 \tag{10}$$

Definition 17 (Definition 1 of Day and Pastró [DP08]; see also Definition 6.4 of Egger [Egg08]). A functor between monoidal categories bearing a monoidal structure and a comonoidal structure, satisfying Equations 10, is said to be *Frobenius monoidal*.

Note that the unadorned “Frobenius” has already been used in [CMZ97] to mean a functor possessing coinciding left and right adjoints; we will have no use of this notion.

Frobenius monoidal functors are so-named because Frobenius monoidal functors from the terminal monoidal category into a category C are in bijection with Frobenius algebras in C . Furthermore, they sport two additional pleasant properties:

- Every strong monoidal functor is Frobenius monoidal (Proposition 3 of [DP08]);
- Every Frobenius monoidal functor preserves duals (Theorem 2 of [DP08]; this is a special case of Corollary A.14 of [CS99]).

For the moment, let us examine the gap between Frobenius monoidal and strong monoidal functors. To demand that a Frobenius monoidal functor be strong is to demand the following four conditions:

$$\begin{array}{ccc}
 \begin{array}{c} x \\ \text{---} \\ x \\ \text{---} \\ y \\ \text{---} \\ y \end{array} & = & \begin{array}{c} x \\ \text{---} \\ x \\ \text{---} \\ y \\ \text{---} \\ y \end{array} \\
 \text{(with a hole)} & & \text{(solid)}
 \end{array}
 \tag{11}$$

$$\begin{array}{ccc}
 \begin{array}{c} x \\ \text{---} \\ x \\ \text{---} \\ y \\ \text{---} \\ y \end{array} & = & \begin{array}{c} x \\ \text{---} \\ x \\ \text{---} \\ y \\ \text{---} \\ y \end{array} \\
 \text{(with a T-shaped hole)} & & \text{(solid)}
 \end{array}
 \tag{12}$$

$$\begin{array}{ccc}
 \begin{array}{c} \text{---} \\ \text{---} \\ \text{---} \\ \text{---} \end{array} & = & \begin{array}{c} \text{---} \\ \text{---} \\ \text{---} \\ \text{---} \end{array} \\
 \text{(two separate pieces)} & & \text{(one solid piece)}
 \end{array}
 \tag{13}$$

$$\begin{array}{ccc}
 \begin{array}{c} \text{---} \\ \text{---} \\ \text{---} \end{array} & = & \begin{array}{c} \text{---} \\ \text{---} \\ \text{---} \end{array} \\
 \text{(one piece with a hole)} & & \text{(solid)}
 \end{array}
 \tag{14}$$

where the blank right-hand-side of the bottom equation denotes the identity on the tensor unit. Following the above intuition of “continuous deformation of f -region”, we see that each condition here fails this intuition. Equations 12, 13, and 14 each posit an equality between two different numbers of “connected components of f -regions”. Equation 11 avoids this fault but instead posits an equality between a “simply connected f -region” and a non-simply connected such region—hence, even at this qualitative topological level, we see that this condition is unlike the others. Thus, we define:

Definition 18 (Definition 6.1 of [Szl05]). A Frobenius monoidal functor is *separable* just when it satisfies Equation 11.

The original motivation for the word “separable” comes from the fact that separable Frobenius monoidal functors $1 \rightarrow \mathcal{C}$ correspond to separable Frobenius algebras in \mathcal{C} in the classical sense. The precise connection between the topology of the functor regions in our depictions and their algebraic properties is spelled out in [MS10].

The category of monoidal categories and Frobenius monoidal functors between them we denote by **fmon**; the full subcategory of separable Frobenius monoidal functors by **sfmon**, and the further full subcategory of *strong* monoidal functors by **strmon**. We shall have no need of strict monoidal functors.

4 The Tannaka Construction

Definition 19. Let \mathcal{V} be a monoidal category. We say that \mathcal{V} is *monoidally complete* if it is complete as a category, and, for every object $b \in \mathcal{V}$, the functors $b \otimes -$ and $- \otimes b$ are both continuous.

Definition 20 (Functors of Reconstruction Type). Let A be a small category and let $F: A \rightarrow \mathcal{V}$ be a functor. We say that F is of *covariant reconstruction type* if the following hold:

- \mathcal{V} is monoidally complete;
- \mathcal{V} is braided monoidal;
- For every $a \in A$, there is a left dual ${}^*(Fa)$ for Fa in \mathcal{V} .

Definition 21. A functor $F: A \rightarrow \mathcal{V}$ is of *contravariant reconstruction type* when F^{op} is of covariant reconstruction type.

Definition 22 (Tannaka Objects). Let $F: A \rightarrow \mathcal{V}$ be a functor of covariant reconstruction type. The *covariant Tannaka object associated to F* is:

$$\tan F = \int_{a \in A} Fa \otimes {}^*(Fa)$$

Many treatments instead consider functors of contravariant reconstruction type, and form

$$\cot F = \int^{a \in A} Fa \otimes {}^*(Fa),$$

this is the *contravariant Tannaka object associated to F* . Note that, since $\cot F = \tan F^{\text{op}}$, we lose no generality by working always with functors of covariant reconstruction type; and we shall do so throughout the remainder of this paper.

In this section, we shall prove the following:

Theorem. *Let $F: A \rightarrow \mathcal{V}$ be a separable Frobenius monoidal functor of covariant reconstruction type. Then $\tan F$ bears the structure of a weak bialgebra. Moreover, if A is autonomous, then $\tan F$ bears the structure of a weak Hopf algebra.*

In a sequel [McC] to this paper, we shall give three refinements of this theorem; namely:

- If A is braided, then $\tan F$ is a braided or quasitriangular weak bialgebra in \mathcal{V} , generalizing the notion of quasitriangular bialgebra [Dri87].
- If A and \mathcal{V} are both tortile categories, then $\tan F$ is a ribbon weak bialgebra in \mathcal{V} , generalizing the notion of ribbon bialgebra [RT90].
- If A is a cyclic category in the sense of [EM10] (that is, having isomorphic left and right duals), then $\tan F$ is a cyclic weak bialgebra. This last generalizes the existing notion of sovereign bialgebra introduced in [Bic01].

Observation 2. The object $\tan F$ acts universally on the functor F , with action $\alpha: \tan F \otimes F \rightarrow F$ is defined to have components:

$$\tan F \otimes Fx = \left(\int_{a \in A} Fa \otimes {}^*(Fa) \right) \otimes Fx \xrightarrow{\pi_x \otimes Fx} Fx \otimes {}^*(Fx) \otimes Fx \xrightarrow{Fx \otimes \epsilon_x} Fx \otimes \top \xrightarrow{\simeq} Fx$$

using the x 'th projection from the end followed by the counit of the ${}^*(Fx) \dashv Fx$ adjunction. By “universality” here, we mean that composition with α mediates a bijection between maps $X \rightarrow \tan F$ in \mathcal{V} and natural transformations $X \otimes F \rightarrow F$, which may be readily verified.

Dually, there is a canonical coaction $\alpha' : F \rightarrow F \otimes \cot F$; see page 254 of Ulbrich [Ulb90].

The dinaturality of the end in a gives rise to the naturality of the above defined action, which we notate as:

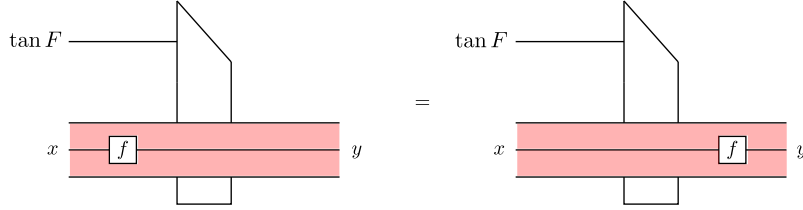

If $F : A \rightarrow \mathcal{V}$ is a functor of representation type, then so too is F^n , by which we mean the functor $A^n \rightarrow \mathcal{V}$ defined by $(a_1, a_2, \dots, a_n) \mapsto Fa_1 \otimes Fa_2 \otimes \dots \otimes Fa_n$. From the action $\alpha : \tan F \otimes F \rightarrow F$, we can obtain actions of $(\tan F)^{\otimes n}$ on F^n , written α^n . Taking $\alpha^1 = \alpha$, we define α^n recursively as follows:

$$\begin{array}{ccc}
 (\tan F)^{\otimes n} \otimes F^n & \xrightarrow{\alpha^n} & F^n \\
 \parallel & & \parallel \\
 (\tan F)^{\otimes(n-1)} \otimes \tan F \otimes F^{n-1} \otimes F & & \\
 \downarrow (\tan F)^{\otimes(n-1)} \otimes \text{braid} \otimes F & & \\
 (\tan F)^{\otimes(n-1)} \otimes F^{n-1} \otimes \tan F \otimes F & \xrightarrow{\alpha^{n-1} \otimes \alpha^1} & F^{n-1} \otimes F
 \end{array}$$

Proposition 2. For each $n \in \mathbb{N}$, the map $\alpha^n : (\tan F)^{\otimes n} \otimes F^n \rightarrow F^n$ exhibits $(\tan F)^{\otimes n}$ as $\tan F^n$.

Proof. Since \mathcal{V} is monoidally complete, tensoring with $\tan F$ preserves ends. The proposition then follows easily from the case $n = 1$ above. \square

Definition 23 (Discharged forms). For any map $f : X \rightarrow (\tan F)^{\otimes n}$ in \mathcal{V} , we call the map

$$X \otimes F^n \xrightarrow{f \otimes F^n} (\tan F)^{\otimes n} \otimes F^n \xrightarrow{\alpha^n} F^n$$

the *discharged form* of f . From the above proposition, two maps are equal if and only if they have the same discharged form.

We will use this property to define algebraic structures on $\tan F$, as well as to verify all of the axioms of those algebraic structures.

4.1 Definition of the Structure

4.1.1 Algebra Structure

Proposition 3. Let $F : A \rightarrow \mathcal{V}$ be a functor of reconstruction type. Then $\tan F$ is an algebra, with multiplication defined as having discharged form:

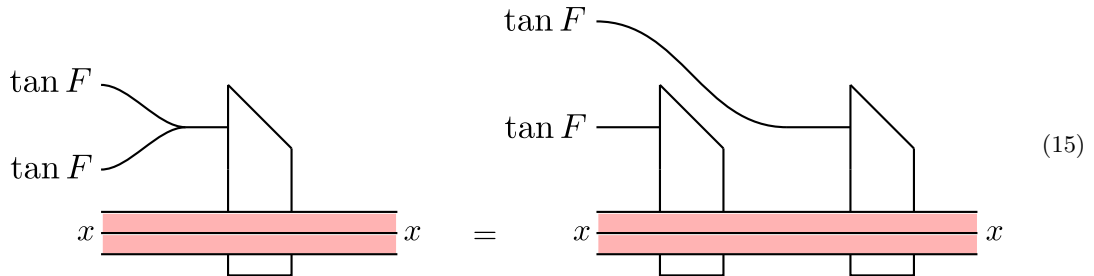

and unit having discharged form:

$$x \text{ (with cap and circle)} = x \text{ (without cap and circle)} \quad (16)$$

Note that this monoidal structure is associative and unital, without assuming that A is monoidal.

4.1.2 Coalgebra Structure

Proposition 4. Suppose that $F: A \rightarrow \mathcal{V}$ is a monoidal and comonoidal functor of reconstruction type. Then, without assuming any coherence between these structures, we can define a coassociative comultiplication on $\tan F$ as having discharged form:

$$\tan F \text{ (with cap and circle)} = \tan F \text{ (without cap and circle)} \quad (17)$$

As well as a counit for $\tan F$:

$$\tan F \text{ (with circle)} = \tan F \text{ (without circle)} \quad (18)$$

Observation 3. These definitions imply that the discharged form of the iterated comultiplication $\tan F \rightarrow (\tan F)^{\otimes n}$ is obtained as:

$$\tan F \otimes Fx_1 \otimes \cdots \otimes Fx_n \xrightarrow{\tan F \otimes \varphi} \tan F \otimes F(x_1 \otimes \cdots \otimes x_n) \xrightarrow{\alpha} F(x_1 \otimes \cdots \otimes x_n) \xrightarrow{\psi} Fx_1 \otimes \cdots \otimes Fx_n$$

4.1.3 Hopf Algebra Structure

Proposition 5. Let $F: A \rightarrow \mathcal{V}$ be a separable Frobenius monoidal functor of reconstruction type, and suppose that A has left duals. Then there is a map $S: \tan F \rightarrow \tan F$ which we think of as a candidate

for an antipode, defined with discharged form:

Notice in particular how the monoidal and comonoidal structures on F permit one to consider the application of F as not merely “boxes” but more like a flexible sheath.

As motivation for this graphical notation, compare a more traditionally rendered definition of S ; as the unique map satisfying:

$$\begin{array}{ccccc}
 \tan F \otimes Fx & \xrightarrow{S \otimes Fx} & \tan F \otimes Fx & \xrightarrow{\alpha_x} & Fx \\
 \downarrow \simeq & & & & \downarrow \simeq^{-1} \\
 \tan F \otimes \top \otimes Fx & & & & Fx \otimes \top \\
 \downarrow \tan F \otimes \varphi_0 \otimes Fx & & & & \downarrow Fx \otimes \psi_0 \\
 \tan F \otimes F\top \otimes Fx & & & & Fx \otimes F\top \\
 \downarrow \tan F \otimes F\tau \otimes Fx & & & & \downarrow Fx \otimes F\gamma \\
 \tan F \otimes F(x \otimes *x) \otimes Fx & & & & Fx \otimes F(x^* \otimes x) \\
 \downarrow \tan F \otimes \psi \otimes Fx & & & & \downarrow Fx \otimes \varphi \\
 \tan F \otimes Fx \otimes F^*x \otimes Fx & \xrightarrow{b \otimes F^*x \otimes Fx} & Fx \otimes \tan F \otimes F^*x \otimes Fx & \xrightarrow{Fx \otimes \alpha^*x \otimes Fx} & Fx \otimes F^*x \otimes Fx
 \end{array}$$

Among other things, for S to be well-defined in this way we must show that the long lower composite is natural in x ; when rendered graphically, this is immediate, even though a careful proof of this fact requires the naturality of α , the naturality of the binary monoidal and comonoidal structure maps, the dinaturality of the unit and counit maps in A , and the naturality of the braid.

Different treatments disagree about whether or not is necessary for the antipode $S: H \rightarrow H$ of a Hopf or weak Hopf algebra to be composition invertible. The above definition seems *not* to be invertible, in general. However, if, in addition to left duals, the category A also has *right* duals, then one can define an analogous map $S^{-1}: H \rightarrow H$, using a “Z-bend” instead of an “S-bend” in the functor region; which the reader may verify is an inverse to this map.

4.2 Verification of Axioms

Having defined all the various structural maps, we now see how they fit together to make bialgebras, weak bialgebras, Hopf algebras, and weak Hopf algebras.

Theorem 1. *Let $F: A \rightarrow \mathcal{V}$ be a separable Frobenius monoidal functor of reconstruction type. Then, with algebra structure defined by Equations 15 and 16 and coalgebra structure defined by Equations 17 and 18, $\tan F$ is a weak bialgebra.*

Proof. First, we verify the Bialgebra Axiom (Equation 7) by the following computations:

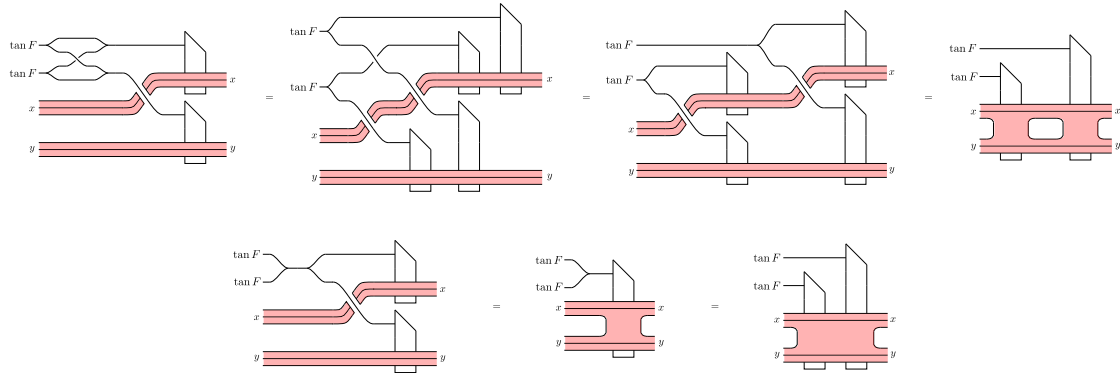

Comparing these shows that it suffices to know $F(x \otimes y) \xrightarrow{\psi} Fx \otimes Fy \xrightarrow{\varphi} F(x \otimes y)$ should be the identity; this is separability of F .

Second, we verify the Weak Unit Axioms (Equations 5). In discharged form, the first unit expression is calculated as:

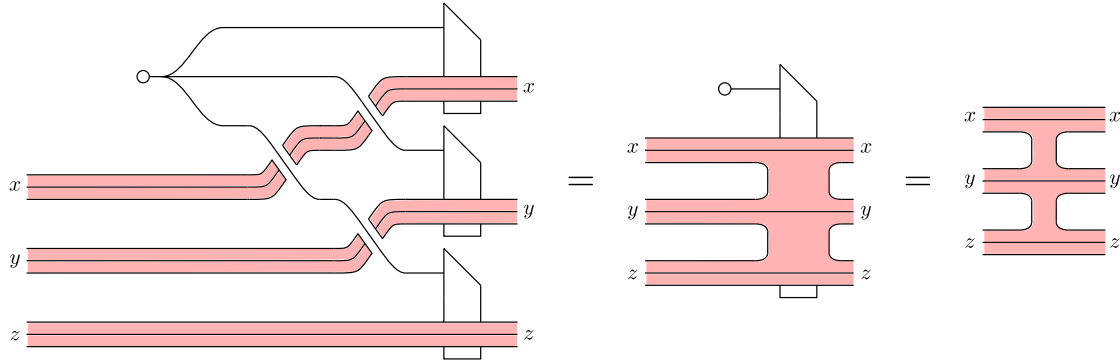

The calculations in Figure 1 show that the second and third unit expressions have the following discharged forms:

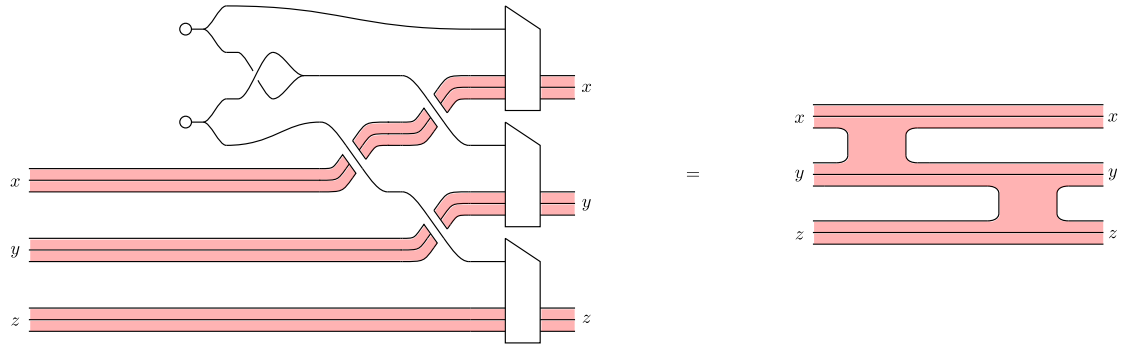
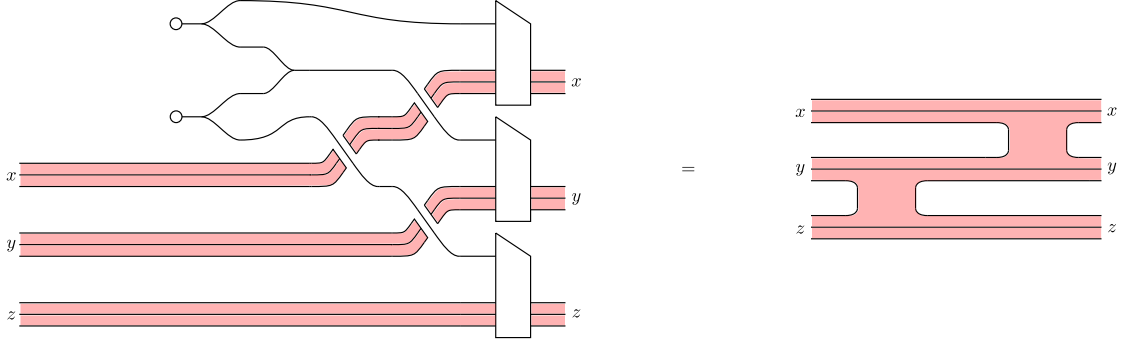

For these unit axioms, we see that it suffices to assume that F is Frobenius monoidal.

Finally, we verify the Weak Counit Axioms (Equations 6). The discharged form of the first of these is easily calculated:

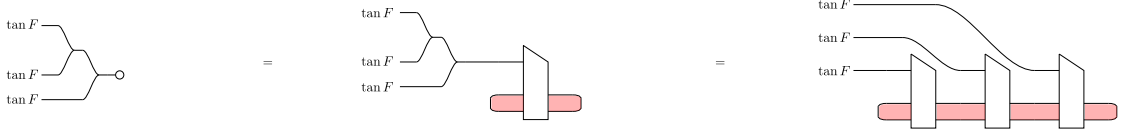

The discharged forms of the second and third counit expression are computed in Figure 2; they are equal, as desired. Examining this figure shows that the counit axioms follow merely from F being both monoidal and comonoidal, without requiring F to be Frobenius monoidal or separable. This completes the proof. \square

This asymmetry between the verifications of the Weak Unit and the Weak Counit Axioms results from working with the *covariant* Tannaka object $\tan F$; had we instead used the contravariant Tannaka object, $\cot F$, the situation would be reversed.

Corollary 1. Let $F: A \rightarrow \mathcal{V}$ be a separable Frobenius monoidal functor of reconstruction type. If F is moreover strong monoidal, then the weak bialgebra $\tan F$ constructed in Theorem 1 is, in fact, a (non-weak) bialgebra.

Proof. As shown by Böhm, Nill, and Szlachányi ([BNS99], page 5), to show that a weak bialgebra is a bialgebra, it suffices to show that the Barbell is trivial (Equation 1) and *either* the Strong Unit Axiom (Equation 2) or the Strong Counit Axiom (Equation 3) holds.

We compute that the barbell of $\tan F$ is:

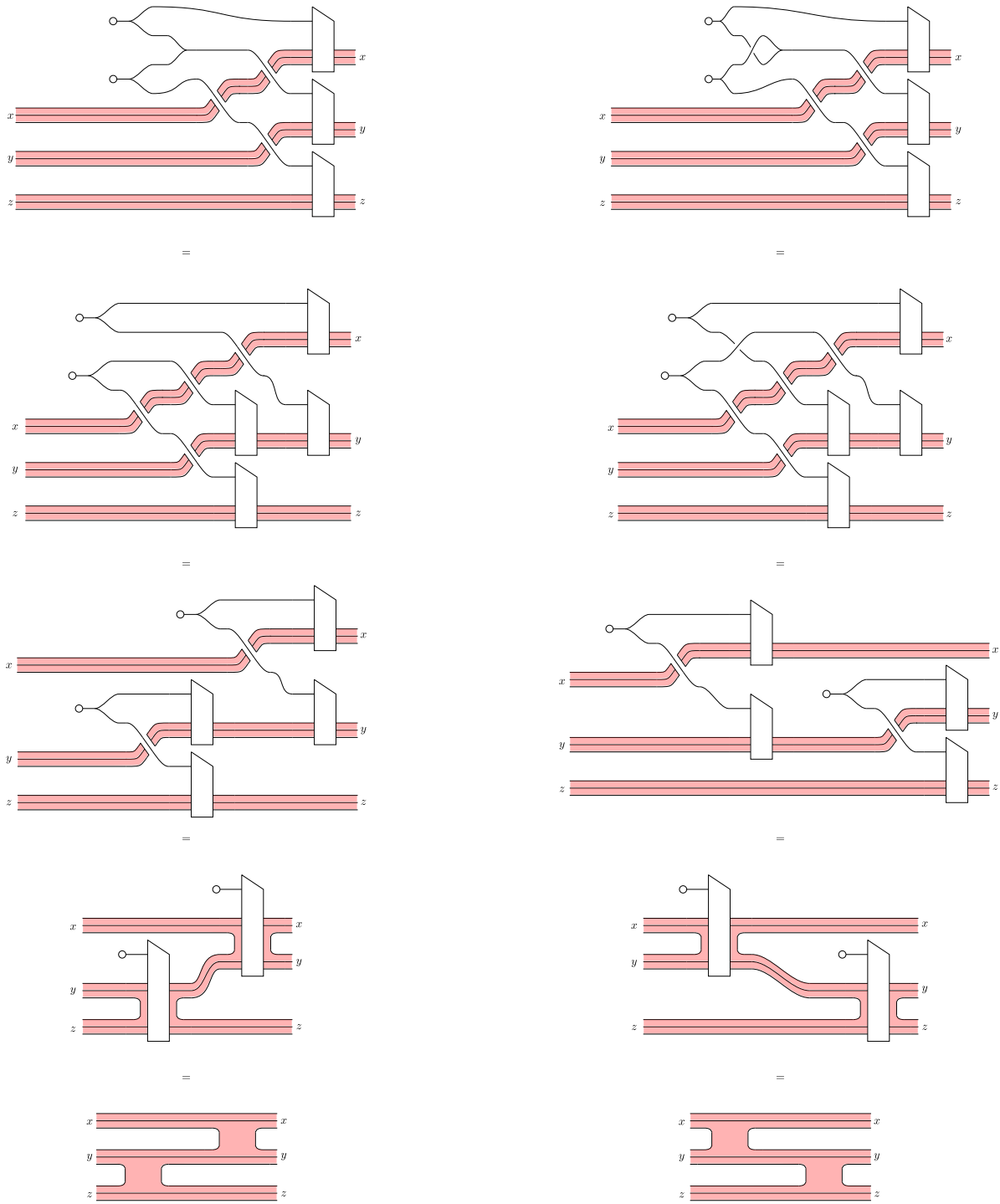

Figure 1: Weak unit calculations. In both calculations, the equalities hold by: definition of the multiplication of $\tan F$; braid axioms; the definition of the comultiplication of $\tan F$; and, finally, the definition of the unit of $\tan F$.

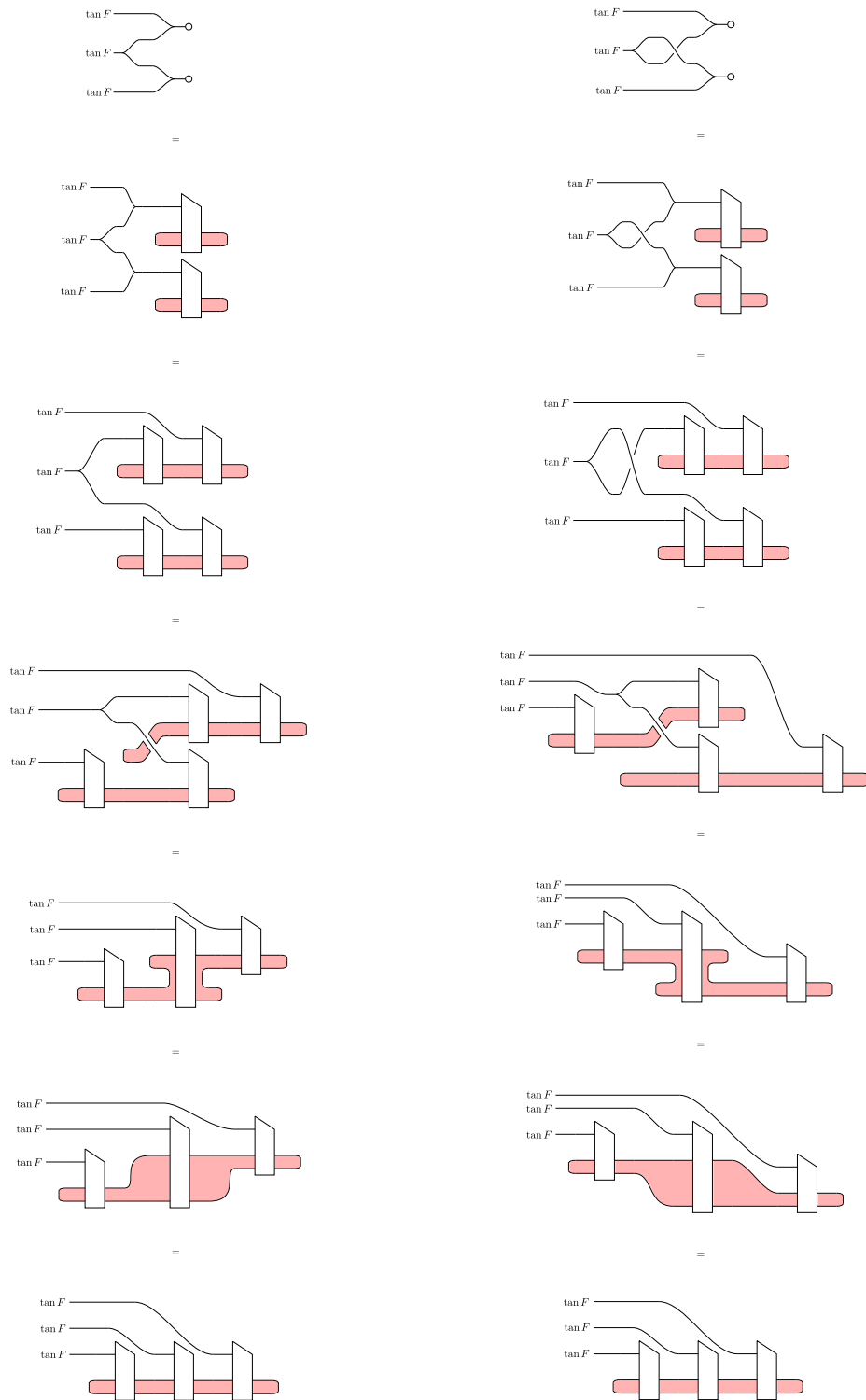
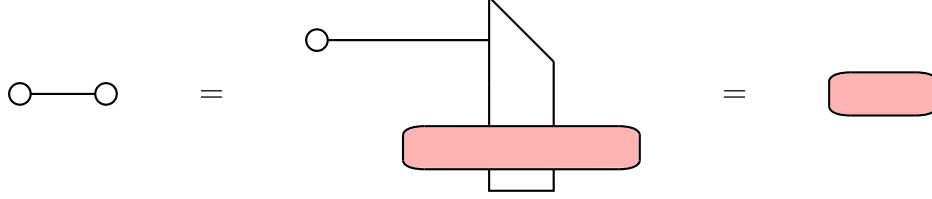
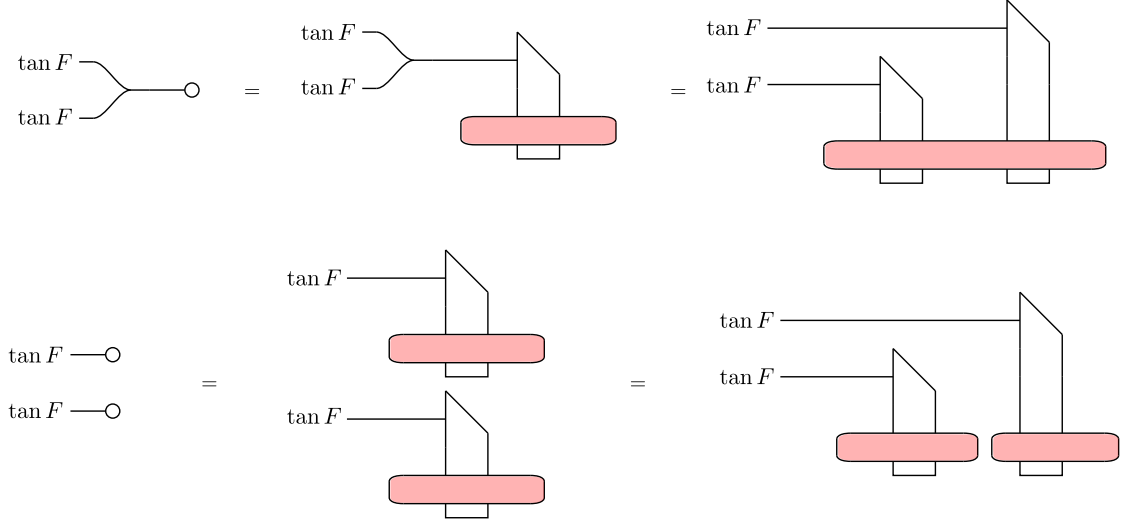

Figure 2: Weak counit calculations



That is, the barbell is the composite $\top \xrightarrow{\varphi_0} F\top \xrightarrow{\psi_0} \top$, which is the identity when F is strong.

We choose to establish the Strong Counit Axiom (Equation 3), using the following two calculations:



and we see that for these two to be equal, it suffices to have $F\top \xrightarrow{\psi_0} \top \xrightarrow{\varphi_0} F\top$ be the identity; which is the case if F is strong. \square

It is equally easy (albeit longer) to verify the bialgebra axioms (Equations 1, 2, 3, and 4) directly.

4.2.1 Hopf Algebras and Weak Hopf Algebras

Theorem 2. *Let $F: A \rightarrow \mathcal{V}$ be a separable Frobenius monoidal functor of reconstruction type, and let $\tan F$ be the weak bialgebra constructed as in Theorem 1. If A has left duals, then the definition of S in Equation 19 equips the weak bialgebra $\tan F$ with a weak Hopf algebra structure.*

Proof. From Theorem 1, we know that $\tan F$ is a weak bialgebra; we must simply verify the three Weak Antipode Axioms (Equations 9). The pair of calculations in Figure 3 compute the discharged forms of $S \star \tan F$ and $\tan F \star S$; and the discharged forms of the idempotents r and t are computed in Figure 4. Comparing the two figures shows $S \star \tan F = r$ and $\tan F \star S = t$ as desired. Finally, we must show that $S \star \tan F \star S = S$; this is shown in Figures 5 and 6. \square

Corollary 2. *Let $F: A \rightarrow \mathcal{V}$ be a separable Frobenius monoidal functor of reconstruction type, and suppose that A has left duals. If F is moreover strong monoidal, then the weak Hopf algebra $\tan F$ constructed in Theorem 2 is a (non-weak) Hopf algebra.*

Proof. From Corollary 4, we know that $\tan F$ is a bialgebra when F is strong monoidal. Therefore, the canonical idempotents r and t which appear in the weak antipode axioms are both equal to the convolution identity, $\eta\epsilon$, and thus the weak antipode axioms (Equations 9) degenerate into the non-weak antipode axioms (Equations 8). \square

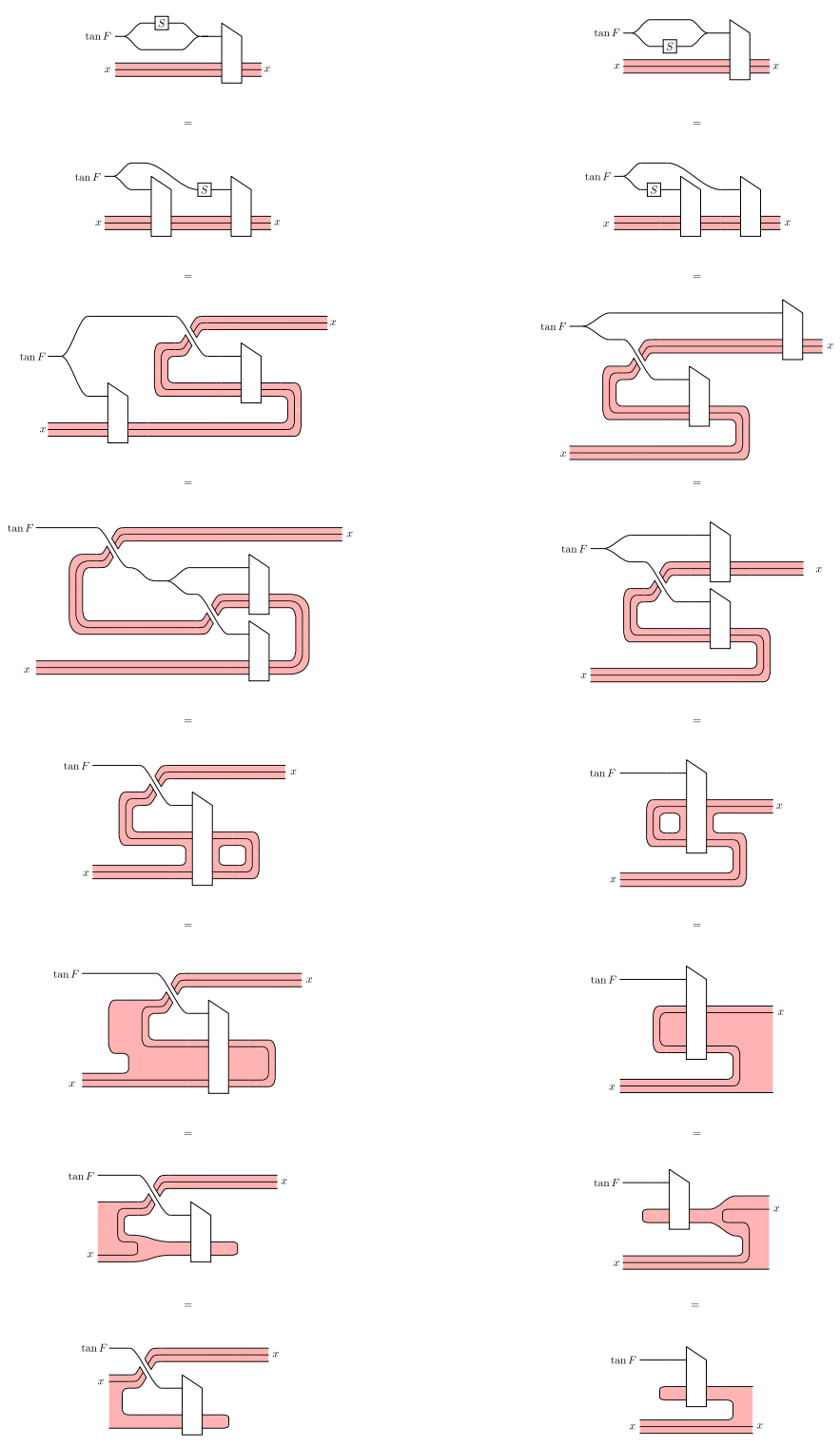

Figure 3: Calculations of $S \star \tan F$ and $\tan F \star S$

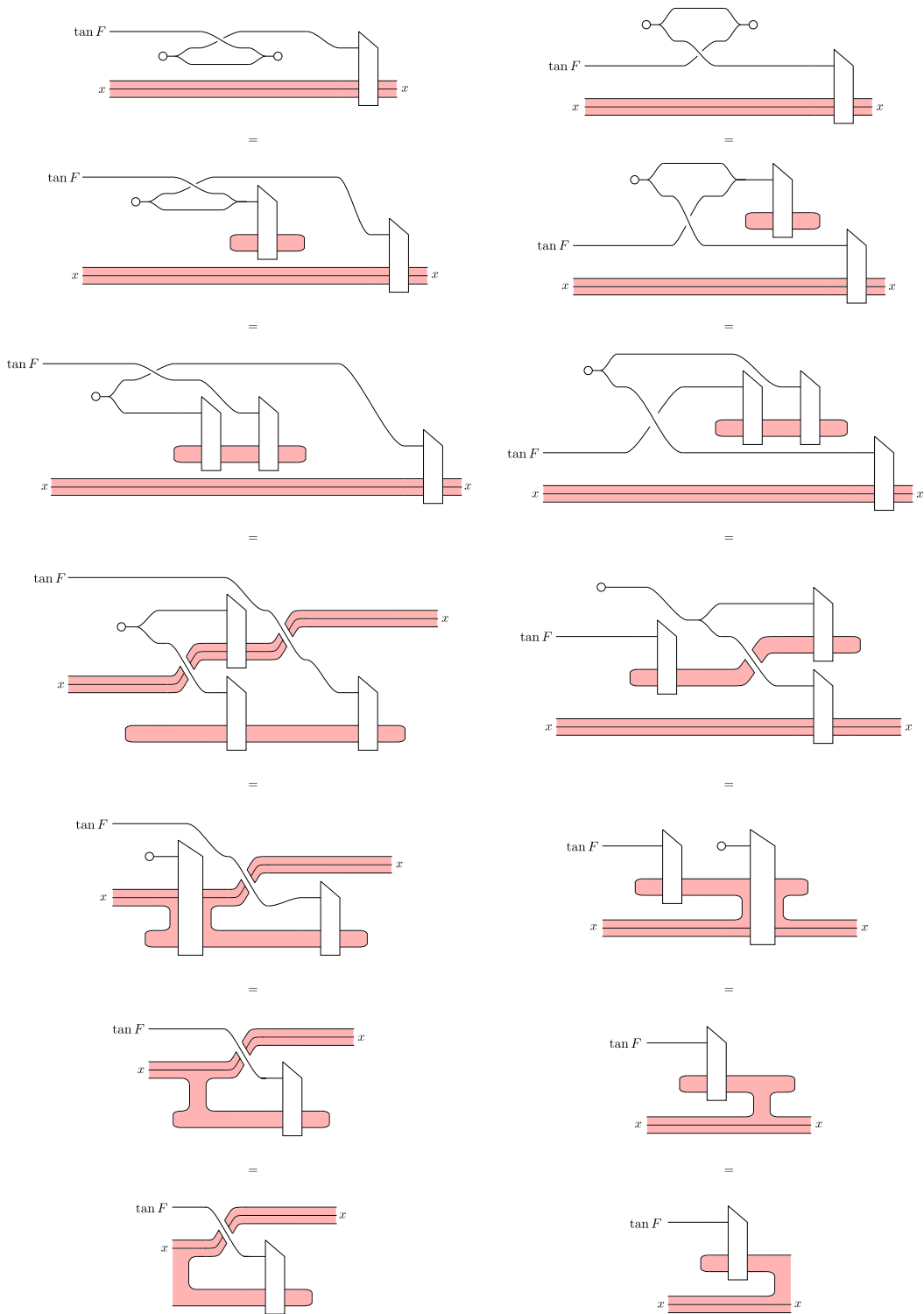

Figure 4: "Source" and "Target" maps

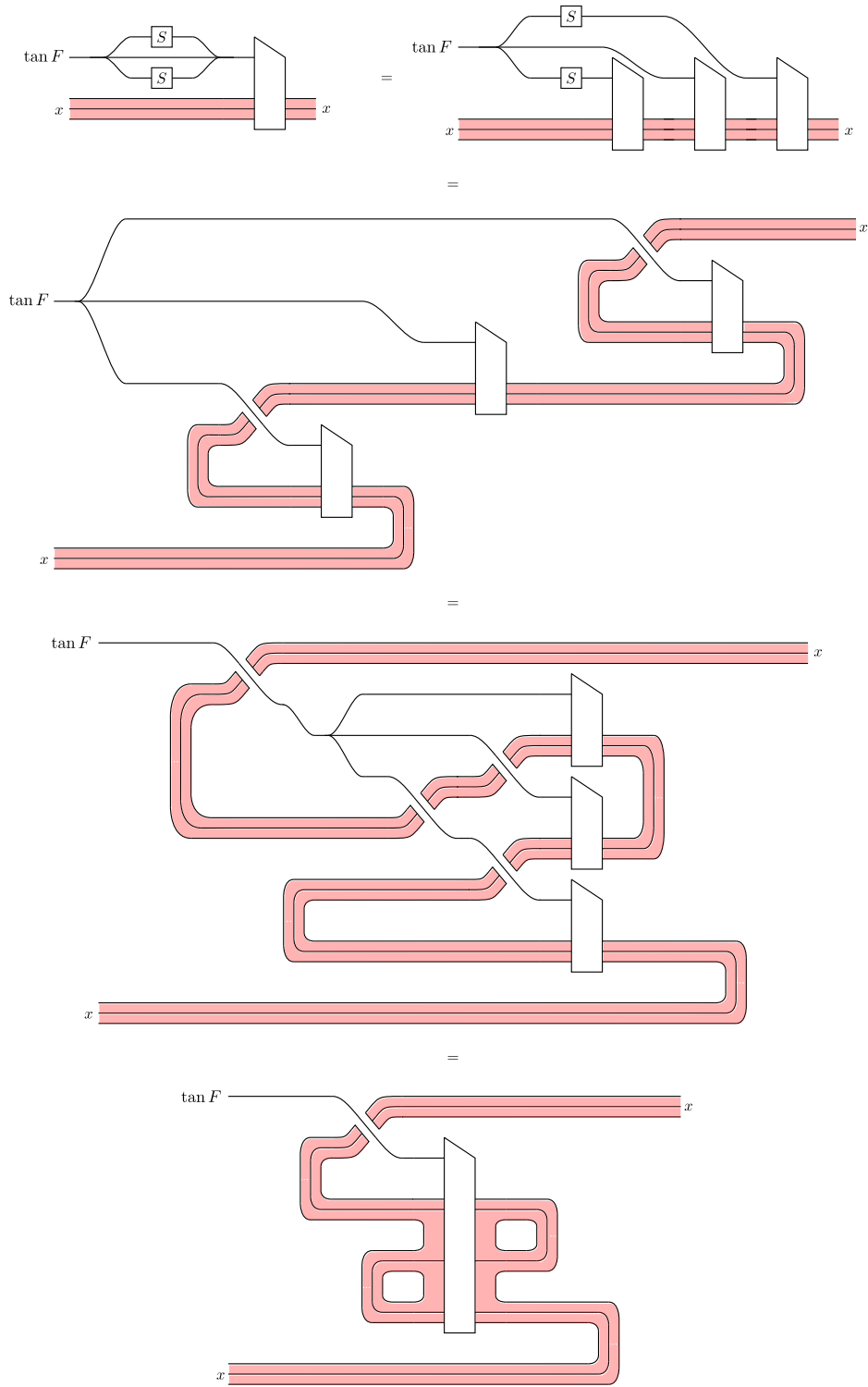

Figure 5: The calculation showing $S \star \tan F \star S = S$ (part 1 of 2). The equalities hold by: definition of the multiplication on $\tan F$; the definition of the antipode on $\tan F$; a slew of naturality and braid axioms; and, finally, the definition of the comultiplication.

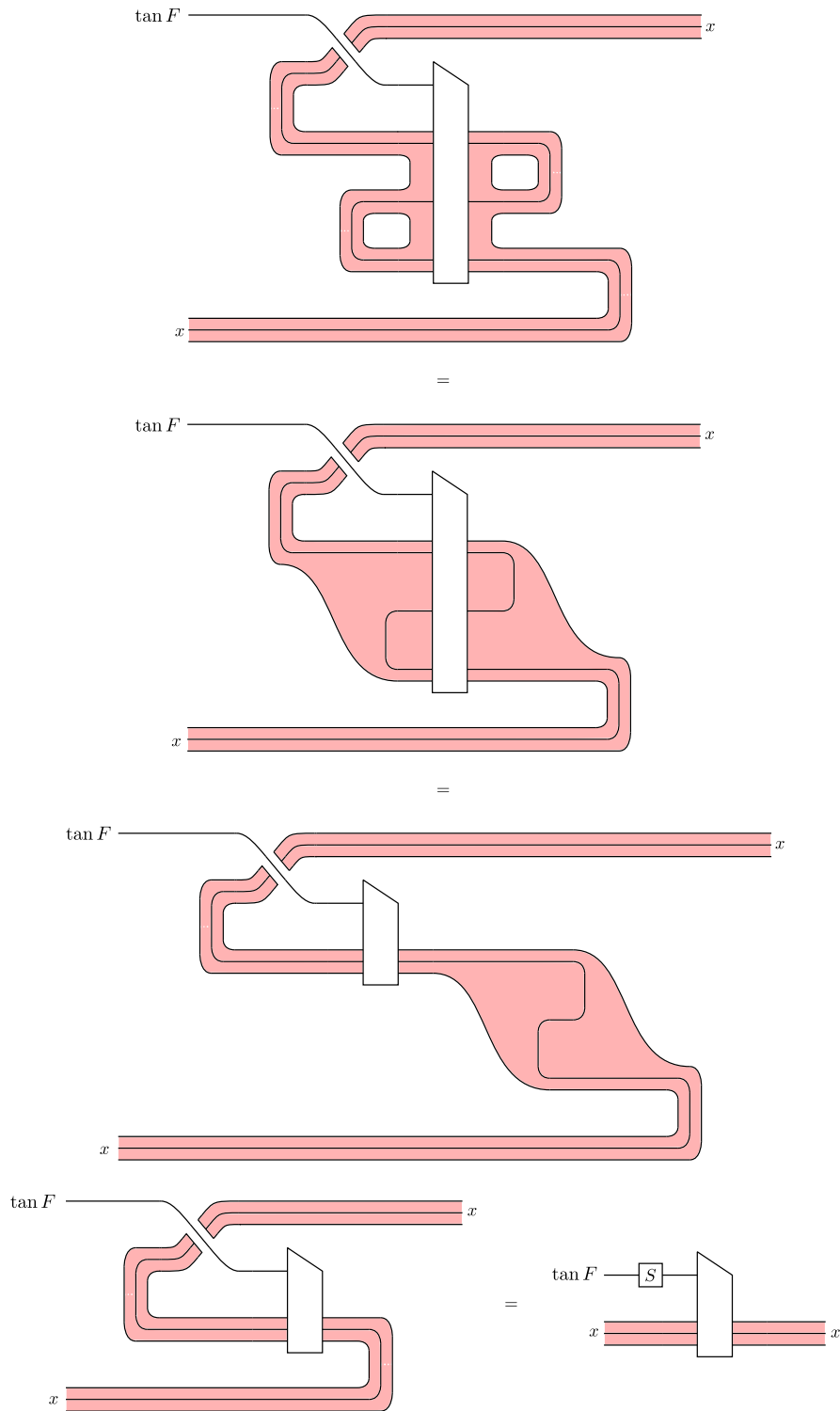

Figure 6: The calculation showing $S \star \tan F \star S = S$ (part 2 of 2). The equalities hold by: two instances of separability of F and one each of F being monoidal and comonoidal; naturality of α ; a triangle identity in A ; and, finally, the definition of the antipode of $\tan F$.

It is routine to verify that the equivalence $Q\mathcal{V} \simeq \mathcal{V}$ lifts to an equivalence $H\text{-mod}_Q \simeq H\text{-mod}$, but we shall nevertheless continue to work in $Q\mathcal{V}$ and $H\text{-mod}_Q$ for clarity.

The unit \top_H for the above monoidal structure is obtained using the canonical idempotent t defined in Section 2.2, namely:

$$\top_H = \left(H, \begin{array}{c} \begin{array}{c} \text{---} H \\ \text{---} H \end{array} \\ \text{---} H \end{array} \text{---} t, t \right)$$

This choice is arbitrary and unimportant, since, as we have remarked above in Proposition 1, all four idempotents are isomorphic. However, the precise form of the nullary monoidal constraint isomorphisms will depend on this choice; here, they are:

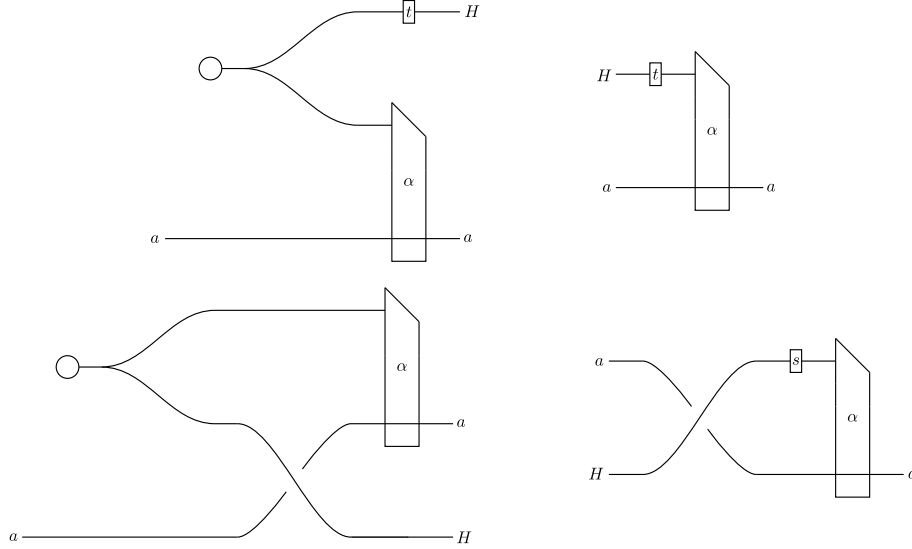

We omit the (routine) verifications that these are well-defined as maps of actions and maps of idempotents.

With these definitions, $U_H: H\text{-mod}_Q \rightarrow Q\mathcal{V}$ inherits a separable Frobenius monoidal structure, with both binary structure maps given by ∇ and nullary structure maps given by:

$$(\top, \top) \xrightarrow{\eta} (H, t) = U_H \top_H \quad U_H \top_H = (H, t) \xrightarrow{\epsilon} (\top, \top)$$

Verifying the various axioms is routine.

5.0.2 Representations of Weak Hopf Algebras

If our weak bialgebra $H \in \mathcal{V}$ is known to be a weak *Hopf* algebra, then its category of representations $H\text{-mod}$ is “as autonomous as \mathcal{V} is”; that is, if an object a has a dual in \mathcal{V} , every representation $(a, \alpha: H \otimes a \rightarrow a)$ of H has a dual in $H\text{-mod}$. For details, see Section 4 of Pastro and Street [PS09], although note that the treatment there uses corepresentations instead of representations. In particular, if \mathcal{V} is autonomous, then $H\text{-mod}_Q$ is also autonomous.

5.1 Extension of the Tannaka Construction and Representation to Morphisms

Given a separable Frobenius monoidal functor $F: A \rightarrow \mathcal{V}$ of reconstruction type, we have described in Section 4 a method for obtaining a weak bialgebra $\text{tan } F$ in \mathcal{V} . Similarly, given a weak bialgebra H in a braided, monoidally complete category \mathcal{V} , the construction in Section 5 produces a separable Frobenius monoidal functor $U: H\text{-mod} \rightarrow \mathcal{V}$ of reconstruction type. Of course, we would like to construe these constructions as the object parts of functors; this will require defining a suitable category of functors into \mathcal{V} and a suitable category of weak bialgebras in \mathcal{V} .

Definition 24. Fix a braided, monoidally complete category \mathcal{V} . Denote by $\mathbf{sfmon} \not\downarrow \mathcal{V}$ the category whose objects are separable Frobenius monoidal functors of reconstruction type into \mathcal{V} . If $F: A \rightarrow \mathcal{V}$ to $G: C \rightarrow \mathcal{V}$ are two such functors, then a morphism $H: F \rightarrow G$ in $\mathbf{sfmon} \not\downarrow \mathcal{V}$ is a separable Frobenius monoidal functor (not necessarily of reconstruction type) $H: A \rightarrow C$ for which $GH = F$.

Another way to view this category is as the full subcategory of the slice category $\mathbf{sfmon}/\mathcal{V}$ determined by the morphisms of reconstruction type; we use the “modified slash” notation to emphasize that $\mathbf{sfmon} \not\downarrow \mathcal{V}$ is *not* itself a slice category, since the objects in $\mathbf{sfmon} \not\downarrow \mathcal{V}$ are required to be of reconstruction type but the morphisms are not.

Definition 25. Fix \mathcal{V} as in the above definition. We denote by $\mathbf{sfmon}^* \not\downarrow \mathcal{V}$ the subcategory of $\mathbf{sfmon} \not\downarrow \mathcal{V}$ determined by the functors of reconstruction type whose domains have left duals.

However, for the morphisms between weak bialgebras, we will need a not-so-well-known notion.

Definition 26. Let H and J be weak bialgebras in \mathcal{V} , and let $f: H \rightarrow J$ be an arrow in \mathcal{V} . We say that f is a *weak morphism of weak bialgebras* (compare [Szl03], Proposition 1.4; the notion here is the union of the notions there of “weak left morphism” and “weak right morphism”) if it:

1. Commutes with the four canonical idempotents on H and J ,
2. Strictly preserves the multiplications and units of H and J , and
3. Weakly preserves the comultiplications of H and J in the sense that:

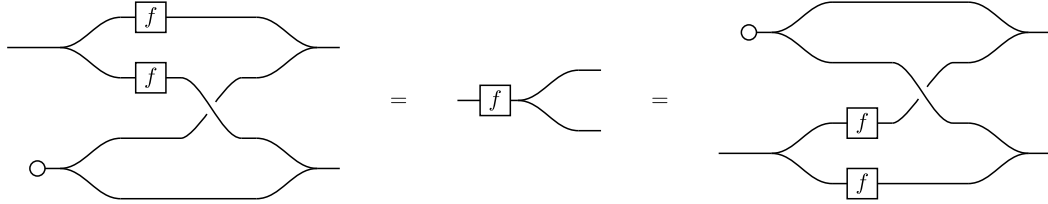

The asymmetry between the preservation of multiplication and preservation of comultiplication corresponds to the choice of modules instead of comodules in the representation theory earlier. Had we chosen to work with comodules, we would instead consider the dual notion of morphisms which strictly preserve the comultiplication and counit but only weakly preserve the multiplication.

It is not too difficult to prove that the composite of two weak morphisms is a weak morphism. The first two conditions pose no difficulty; as for the third condition, we prove the second equality by the following:

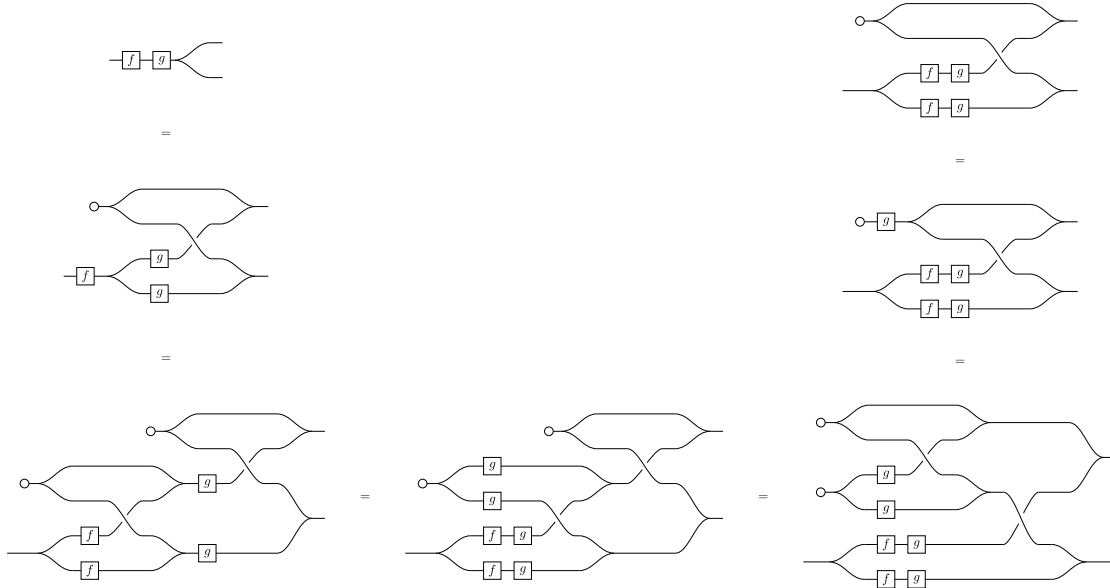

In counter-clockwise order from top-left, the equalities hold since: g weakly preserves comultiplication; f weakly preserves comultiplication; g strictly preserves multiplication; associativity of multiplication and some braid axioms; g weakly preserves comultiplication; g strictly preserves units.

The first equality in condition 3 is proved similarly. In sum, weak morphisms between weak bialgebras in a braided monoidal category \mathcal{V} form a category which we write as $\mathbf{wba}\mathcal{V}$. We define a weak morphism of weak Hopf algebras to be a weak morphism between underlying weak bialgebras, and we denote this category by $\mathbf{wha}\mathcal{V}$.

Observation 4. Every strong morphism of weak bialgebras (that is, one strictly preserving the units, counits, multiplications and comultiplications) is a weak morphism of weak bialgebras, and, moreover, if the weak bialgebra is in fact a usual bialgebra, then the notions of weak and strong morphism coincide. In particular, this means that we have inclusions $\mathbf{ba}\mathcal{V} \rightarrow \mathbf{wba}\mathcal{V}$ and $\mathbf{ha}\mathcal{V} \rightarrow \mathbf{wha}\mathcal{V}$.

5.2 Extension of Tannaka Construction to morphisms

In this section we extend the Tannaka construction described in Section 4 to a functor

$$\tan: \mathbf{sfmon} \downarrow \mathcal{V} \rightarrow \mathbf{wba}\mathcal{V}$$

Suppose that

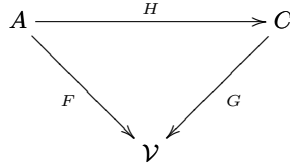

is a morphism $H: F \rightarrow G$ in $\mathbf{sfmon} \downarrow \mathcal{V}$. We must obtain from such a commuting triangle a weak morphism of weak Hopf algebras $\tan H: \tan G \rightarrow \tan F$. A morphism from $\tan G$ into $\tan F$ is the same thing as an action of $\tan G$ on F ; we take here the canonical action

$$\tan G \otimes F = \tan G \otimes GH \xrightarrow{\alpha_H} GH = F$$

Graphically, we write this as:

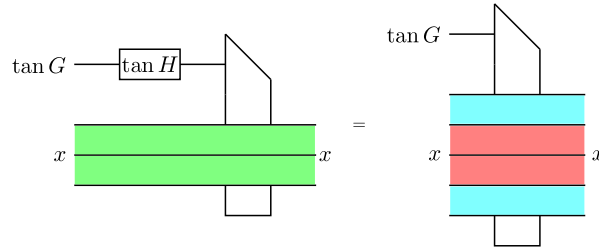

where we have written F as green, H as red, and G as blue. Note that the boundaries of this definition are equal precisely because $F = GH$.

We must verify that $\tan H$ strictly preserves the monoidal structures of $\tan G$ and $\tan F$ and weakly preserves their comultiplication. As for the unit, it is immediate:

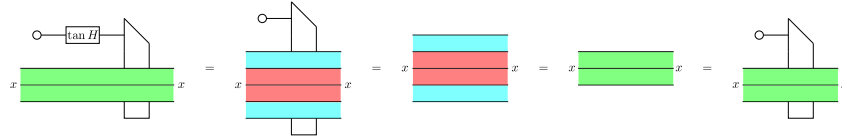

And the multiplication is similarly easy:

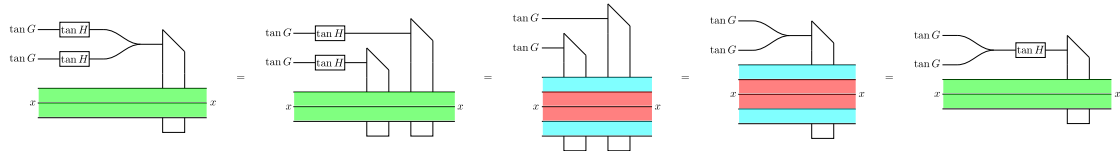

However, as expected for a weak morphism of weak bialgebras, $\tan H$ need not strictly preserve the comultiplications. On the one hand, we compute the discharged form of $\tan G \xrightarrow{\Delta} \tan G \otimes \tan G \xrightarrow{\tan H \otimes \tan H} \tan F \otimes \tan F$:

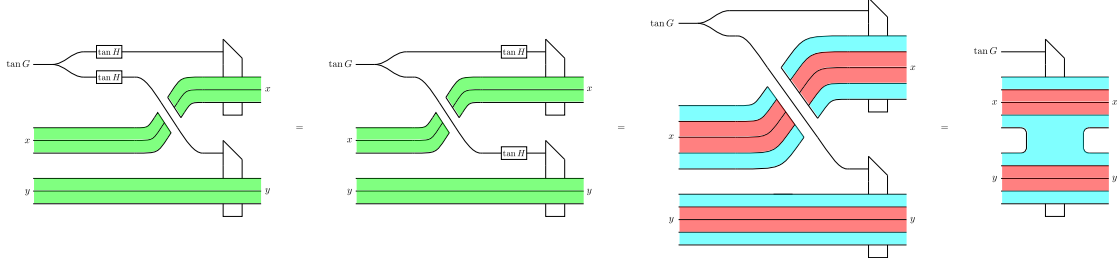

Whereas, on the other hand, we compute the discharged form of $\tan G \xrightarrow{\tan H} \tan F \xrightarrow{\Delta} \tan F \otimes \tan F$:

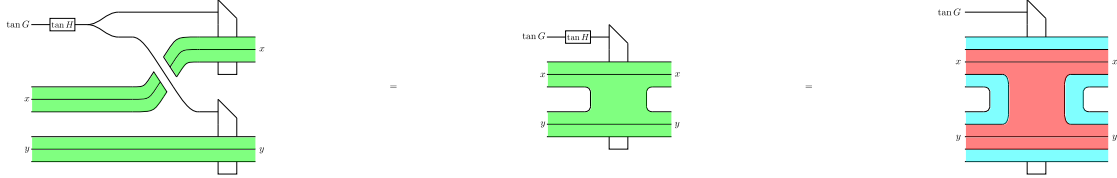

Certainly the above shows that, if H is strong monoidal, $\tan H$ will preserve the comultiplications strictly. As an aside, we investigate whether $\tan H$ preserves the counits. On the one hand, we compute:

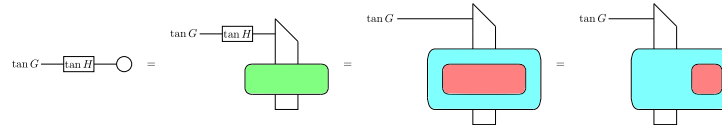

And on the other hand, we compute:

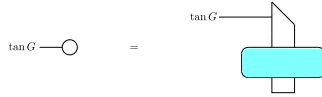

So we see that, for $\tan H$ to preserve the counits, it suffices for H to be strong; specifically, for the composite $\top \xrightarrow{\varphi_0} H\top \xrightarrow{\psi_0} \top$ to be the identity.

We proceed to show that $\tan H$ weakly respects the comultiplications of $\tan G$ and $\tan H$. We show the second equality of Condition 3 in the definition of weak morphism, the first equality is proved similarly. First, we compute the discharged form of $\top \xrightarrow{\eta} \tan G \xrightarrow{\delta} \tan G \otimes \tan G$ as:

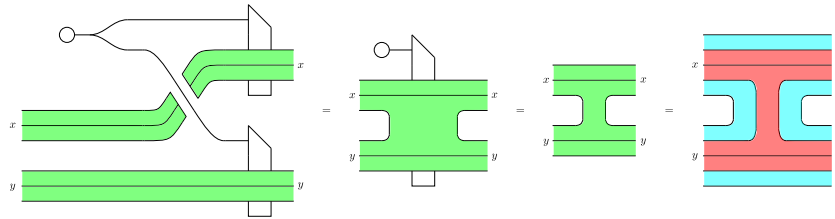

Second, exploiting the basic fact that the discharged form of a product is the composite of discharged forms, we see that the discharged form of

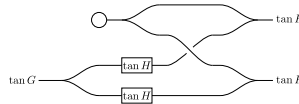

is:

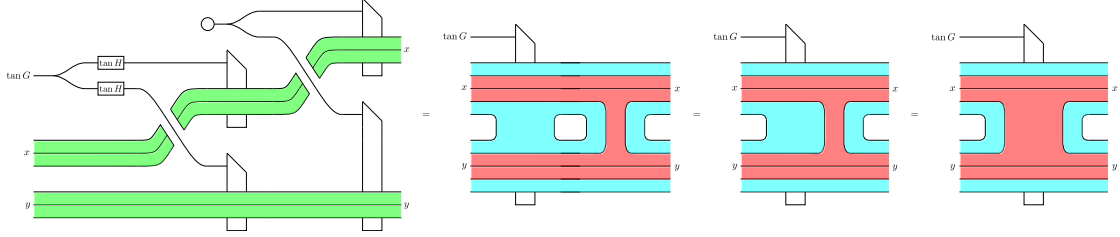

where we have used the fact that G is separable followed by the naturality of the canonical action of $\tan G$ on G . Thus, $\tan H$ respects the comultiplications of $\tan H$ and $\tan G$ in the sense required of a weak morphism of weak bialgebras.

Finally, we must check that $\tan H$ commutes with the four canonical idempotents. We show that $(\tan H)r = r(\tan H)$ by the following chain of calculation:

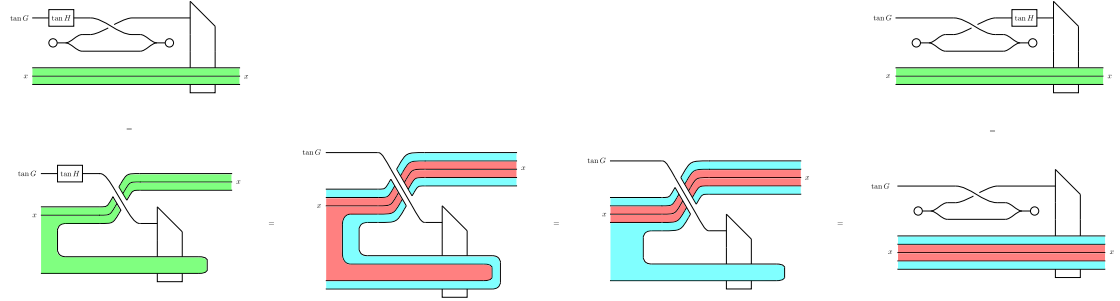

Counter-clockwise from top-left, the equalities hold by: the discharged form of r from the left-hand column of Figure 4; the definition of $\tan H$; naturality of action and the monoidality of F ; the discharged form of r once again; and finally the definition of $\tan H$ again. The proofs that $\tan H$ respects the other three idempotents are similar.

Thus, we have that, for H an arrow in $\mathbf{sfmon} \downarrow \mathcal{V}$, the arrow $\tan H$ is a weak morphism of weak bialgebras. It is routine to verify that \tan defined on morphisms in this way preserves composition and identities; hence, we have a functor:

$$\tan: \mathbf{sfmon} \downarrow \mathcal{V} \longrightarrow (\mathbf{wba} \mathcal{V})^{\text{op}}$$

And, if we restrict to the full subcategory of $\mathbf{sfmon} \downarrow \mathcal{V}$ consisting of functors with autonomous domain, we have a functor:

$$\tan: \mathbf{sfmon}^* \downarrow \mathcal{V} \longrightarrow (\mathbf{wha} \mathcal{V})^{\text{op}}$$

5.3 Extension of the Representation Theory to Morphisms

Let $f: H \rightarrow J$ be a weak morphism of weak bialgebras. We define $f^* = Q(f\text{-mod}): J\text{-mod}_Q \rightarrow H\text{-mod}_Q$ to have action on objects:

$$f^* \left(a, \begin{array}{c} H \\ \alpha \\ a \end{array} \Big|_a, a' \right) = \left(a, \begin{array}{c} H \\ \alpha \\ a \end{array} \Big|_a, a' \right)$$

and to be the identity on morphisms.

Since f strictly preserves the unit and the multiplication, f^* takes associative and unital J -modules to associative and unital H -modules, as required. It is clear that, as mere functors, $U_H f^* = U_J$. What is considerably more complicated is the separable Frobenius monoidal structure on f^* . Let us agree to abbreviate the right-hand side of the above definition as f^*a , to simplify notation.

We compute

$$\begin{aligned}
f^*a \otimes_H f^*b &= \left(a, \begin{array}{c} H \text{---} \boxed{J} \\ \alpha \\ a \text{---} \end{array} , a' \right) \otimes_H \left(b, \begin{array}{c} H \text{---} \boxed{J} \\ \beta \\ a \text{---} \end{array} , b' \right) \\
&= \left(a \otimes b, \begin{array}{c} \begin{array}{c} H \text{---} \boxed{J} \\ \alpha \\ a \text{---} \end{array} \\ \begin{array}{c} H \text{---} \boxed{J} \\ \beta \\ a \text{---} \end{array} \\ b \text{---} \end{array} , \begin{array}{c} \begin{array}{c} H \text{---} \boxed{J} \\ \alpha \\ a \text{---} \end{array} \\ \begin{array}{c} H \text{---} \boxed{J} \\ \beta \\ a \text{---} \end{array} \\ b \text{---} \end{array} \right) \\
f^*(a \otimes_J b) &= f^* \left(\left(a, \begin{array}{c} H \text{---} \boxed{\alpha} \\ \alpha \\ a \text{---} \end{array} , a' \right) \otimes_J \left(b, \begin{array}{c} H \text{---} \boxed{\beta} \\ \beta \\ a \text{---} \end{array} , b' \right) \right) \\
&= f^* \left(a \otimes b, \begin{array}{c} \begin{array}{c} H \text{---} \boxed{\alpha} \\ \alpha \\ a \text{---} \end{array} \\ \begin{array}{c} H \text{---} \boxed{\beta} \\ \beta \\ a \text{---} \end{array} \\ b \text{---} \end{array} , \nabla_{a,b} \right) = \left(a \otimes b, \begin{array}{c} \begin{array}{c} H \text{---} \boxed{J} \\ \alpha \\ a \text{---} \end{array} \\ \begin{array}{c} H \text{---} \boxed{J} \\ \beta \\ a \text{---} \end{array} \\ b \text{---} \end{array} , \nabla_{a,b} \right)
\end{aligned}$$

By condition 3 of f being a weak morphism of weak Hopf algebras, we can view $\nabla_{a,b}$ as a monoidal structure $f^*a \otimes_H f^*b \rightarrow f^*(a \otimes_J b)$ as well as a comonoidal structure $f^*(a \otimes_J b) \rightarrow f^*a \otimes_H f^*b$. Moreover, this is clearly separable, since the idempotent on $f^*(a \otimes_J b)$ is $\nabla_{a,b}$. However, since the idempotent on $f^*a \otimes_H f^*b$ is *not* equal to $\nabla_{a,b}$, the composite

$$f^*a \otimes_H f^*b \rightarrow f^*(a \otimes_J b) \rightarrow f^*a \otimes_H f^*b$$

is not necessarily the identity.

Furthermore, for the nullary structure, we compute:

$$\begin{aligned}
\top_H &= \left(H, \begin{array}{c} H \text{---} \\ \boxed{t} \\ H \text{---} \end{array} , t \right) \\
f^*\top_J &= f^* \left(J, \begin{array}{c} J \text{---} \\ \boxed{t} \\ J \text{---} \end{array} , t \right) \\
&= \left(J, \begin{array}{c} H \text{---} \boxed{J} \\ \boxed{t} \\ J \text{---} \end{array} , t \right)
\end{aligned}$$

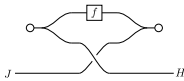
We define $\top_H \rightarrow f^*\top_J$ to be ft and $f^*\top_J \rightarrow \top_H$ to be . Notice that, when f is the identity, both the monoidal and comonoidal structure are t ; which is to say that $(-)^*$ preserves identities.

It is a somewhat lengthy verification to show that all of the above maps are well-defined and constitute a separable Frobenius monoidal structure on f^* ; we consider the Frobenius axioms themselves (Equations 10), leaving the other details to the reader. To save space, we label each of the morphisms in the diagrams below with the element of $H \otimes H \otimes H$ which acts on $a \otimes b \otimes c$, according to the definition

of ∇ and the tensor products \otimes_H and \otimes_J . From the above definition:

$$\begin{array}{ccc}
f^*(a \otimes_J b) \otimes_H f^*c & \xrightarrow{\quad} & f^*a \otimes_H f^*b \otimes_H f^*c \\
\downarrow & & \downarrow \\
f^*(a \otimes_J b \otimes_J c) & \xrightarrow{\quad} & f^*a \otimes_H f^*(b \otimes_J c) \\
\downarrow & & \downarrow \\
f^*a \otimes_H f^*(b \otimes_J c) & \xrightarrow{\quad} & f^*a \otimes_H f^*b \otimes_H f^*c \\
\downarrow & & \downarrow \\
f^*(a \otimes_J b \otimes_J c) & \xrightarrow{\quad} & f^*(a \otimes_J b) \otimes_H f^*c
\end{array}$$

Easy calculations show that the bottom-left composites of the above are:

$$\text{Diagram 1} * \text{Diagram 2} = \text{Diagram 3} = \text{Diagram 4} * \text{Diagram 5}$$

Furthermore, the top-right composites of the above squares are calculated as:

$$\text{Diagram 6} * \text{Diagram 7} = \text{Diagram 8} \qquad \text{Diagram 9} * \text{Diagram 10} = \text{Diagram 11}$$

Therefore, we see that these squares commute precisely because of the Weak Unit Axioms (Equations 5) for J .

Further calculations show that $(gf)^* = g^*f^*$ as Frobenius monoidal functors; consequently, we obtain a functor:

$$\text{mod}: (\mathbf{wba} \mathcal{V})^{\text{op}} \longrightarrow \mathbf{sfmon} \int \mathcal{V}$$

Since weak morphisms between weak Hopf algebras are simply weak morphisms between their underlying weak bialgebras, and strong monoidal functors between autonomous categories are simply strong monoidal functors between their underlying monoidal categories, this mod restricts to a functor:

$$\text{mod}: (\mathbf{wha} \mathcal{V})^{\text{op}} \longrightarrow \mathbf{sfmon}^* \int \mathcal{V}$$

6 The Tannaka Adjunction

In this section, we will show that the functors defined in the previous two sections form an adjunction, specifically:

$$\begin{array}{ccc}
\mathbf{sfmon} \int \mathcal{V} & \xrightarrow{\quad \text{tan} \quad} & (\mathbf{wba} \mathcal{V})^{\text{op}} \\
& \perp & \\
& \xleftarrow{\quad \text{mod} \quad} &
\end{array}$$

Furthermore, there is a restricted adjunction:

$$\begin{array}{ccc}
\mathbf{sfmon}^* \int \mathcal{V} & \xrightarrow{\quad \text{tan} \quad} & (\mathbf{wha} \mathcal{V})^{\text{op}} \\
& \perp & \\
& \xleftarrow{\quad \text{mod} \quad} &
\end{array}$$

6.0.1 Units and Counits

Let H be a weak Hopf algebra in \mathcal{V} . We define a unit $\eta: H \rightarrow \tan U_H$, where $U_H: H\text{-mod} \rightarrow \mathcal{V}$ is the forgetful functor. Specifically, we define η to correspond to the obvious action $\tilde{\alpha}: H \otimes U_H \rightarrow U_H$ whose component at an H -module (A, α) is α . This is readily checked to be natural in H , and a *strong* morphism of weak bialgebras; for instance, the following diagram shows that η respects the counits:

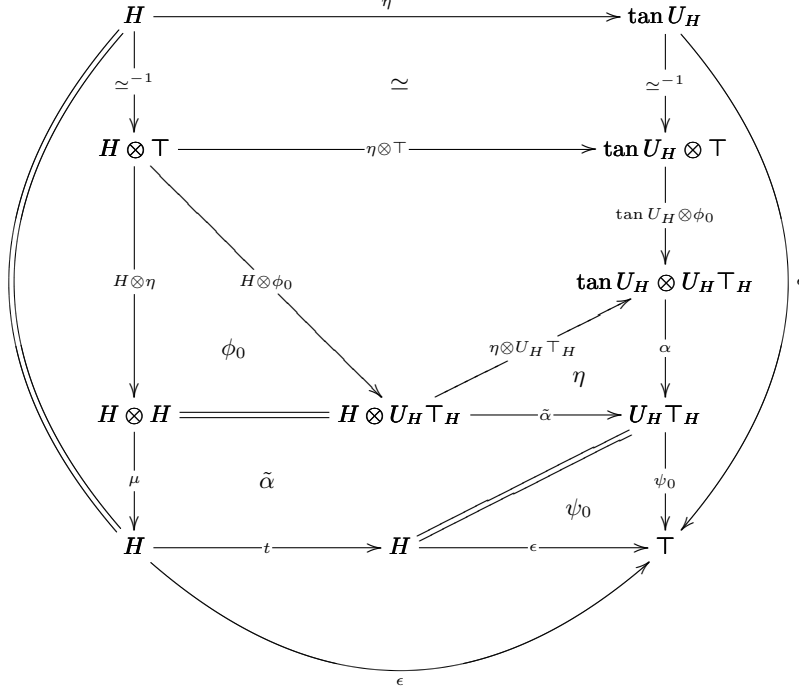

The irregular central cell commutes since \otimes is functorial; the cell marked \simeq commutes by naturality of \simeq ; the left-hand bubble commutes since H is a unital algebra; the right-hand bubble commutes by definition of ϵ ; the cell marked ϕ_0 commutes by definition of ϕ_0 ; the cell marked η commutes by definition of η ; the cell marked $\tilde{\alpha}$ commutes by definition of $\tilde{\alpha}$, since the tensor unit T_H in $H\text{-mod}$ is $(H, t\mu, t)$; the lower bubble is an easy calculation; and the cell labelled ψ_0 commutes by the definition of ψ_0 given in Section 5.

Let $F: A \rightarrow \mathcal{V}$ be a separable Frobenius functor of reconstruction type. We define a (contravariant) counit $\epsilon_F: A \rightarrow (\tan F)\text{-mod}$ by taking every object x of A to Fx equipped with the canonical $\tan F$ action. Specifically:

$$\epsilon x = \left(Fx, \tan F \otimes Fx \xrightarrow{\alpha} Fx, Fx \right)$$

and furthermore, that

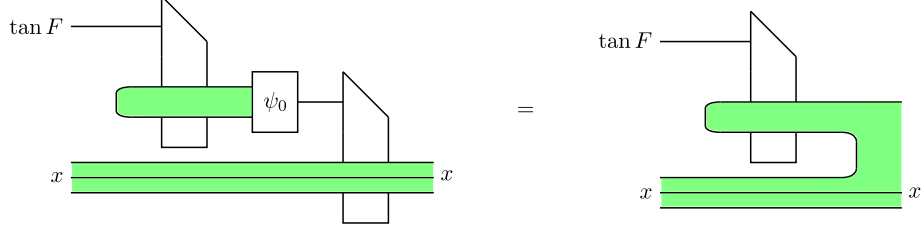

which we recognize from the right-hand-side of Figure 4 as the discharged form of the idempotent t on $\tan F$, as required. Furthermore, ϵ commutes with F and $U_{\tan F}$ as a Frobenius functor since F is separable. Note in particular that, although F is not strong, ϵ is strong, since the identity on $\epsilon x \otimes \epsilon y$ is the idempotent given.

Hence, this ϵ defines a morphism $F \rightarrow U_{\tan F}$ in $\mathbf{sfmon} \downarrow \mathcal{V}$ and is, in fact, *strong* monoidal. Furthermore, it is easily seen to be natural in F .

We must verify the triangle identities for the adjunction $\tan \dashv \text{mod}$. On the one hand, let a weak bialgebra H be given, we must show that

$$\text{mod } H \xrightarrow{\epsilon_{U_H}} \text{mod}(\tan U_H) \xrightarrow{\text{mod}(\eta_H)} \text{mod } H$$

is the identity. Hence, let $(a, \gamma: H \otimes a \rightarrow a)$ in $\text{mod } H$ be given. We compute that

$$\begin{aligned} \text{mod}(\eta_H) \epsilon_{U_H} \left(a, H \otimes a \xrightarrow{\gamma} a \right) &= \text{mod}(\eta_H) \left(a, \tan U_H \otimes U_H(a, \gamma) \xrightarrow{\alpha} U_H(a, \gamma) \right) \\ &= \left(a, H \otimes U_H(a, \gamma) \xrightarrow{\eta_{N \otimes U_H(a, \gamma)}} \tan U_H \otimes U_H(a, \gamma) \xrightarrow{\alpha} U_H(a, \gamma) \right) \\ &= \left(a, H \otimes U_H(a, \gamma) \xrightarrow{\alpha} U_H(a, \gamma) \right) \\ &= \left(a, H \otimes a \xrightarrow{\gamma} a \right) \end{aligned}$$

Where the equalities hold: by definition of ϵ , by definition of mod , and by definition of η . On the other hand, let $F: A \rightarrow \mathcal{V}$ be a separable Frobenius monoidal functor of reconstruction type; we must show that

$$\tan F \xrightarrow{\eta_{\tan F}} \tan U_{\tan F} \xrightarrow{\tan \epsilon_F} \tan F$$

is the identity. For this, consider the following diagram:

$$\begin{array}{ccccc} \tan F \otimes F & \xrightarrow{\eta_{\tan F \otimes F}} & \tan U_{\tan F} \otimes F & \xrightarrow{\tan \epsilon_F \otimes F} & \tan F \otimes F \\ \downarrow \alpha & \searrow & \downarrow \alpha & \swarrow & \downarrow \alpha \\ \tan F \otimes U_{\tan F \epsilon_F} & \xrightarrow{\eta_{\tan F \otimes U_{\tan F \epsilon_F}}} & \tan U_{\tan F} \otimes U_{\tan F \epsilon_F} & & \\ \downarrow \alpha & \searrow \alpha & \downarrow \alpha & & \downarrow \alpha \\ F & \xrightarrow{\quad} & U_{\tan F \epsilon_F} & \xrightarrow{\quad} & F \end{array}$$

The upper cell commutes since $U_{\tan F \epsilon_F} = F$; the left-hand cell commutes by definition of ϵ ; the right-hand cell commutes by definition of \tan ; and the central cell commutes by definition of η . Hence, we have shown that:

$$\alpha(\tan \epsilon_F \eta_{\tan F} \otimes F) = \alpha$$

which, by the universal property of α , gives

$$\tan \epsilon_F \eta_{\tan F} = \tan F$$

as desired. Hence, we have that $\tan \dashv \text{mod}$, as desired.

Furthermore, we have noted that the components of η and ϵ are actually strong, and that the functors \tan and mod are well-defined when simultaneously restricted to strong morphisms of weak bialgebras and strong monoidal functors between separable Frobenius functors. Therefore, this restricted “tan” is left adjoint to this restricted “mod”. This restricted adjunction is well-known; see, for instance, Section 16 of Street [Str07].

So, we have proved:

Proposition 6. There is a linked pair of adjunctions:

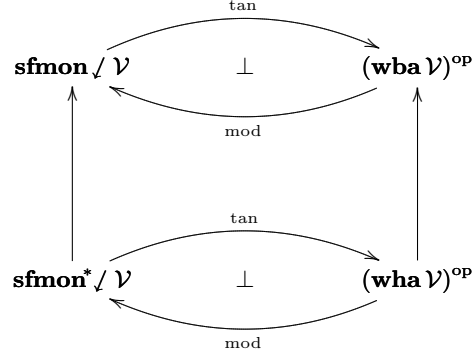

Where the diagram commutes serially. Furthermore, we can restrict to non-weak bialgebras and strong monoidal functors, and the above adjunctions restrict to the well-known adjunctions:

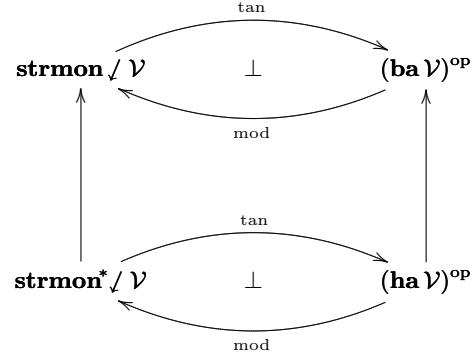

There is an evident quadruple of inclusions from the four categories in this last diagram to the four categories in the first diagram, making in all a commutative square of adjunctions.

6.1 The Internal Separable Frobenius Algebra in $\tan F$

We have seen above that the nullary monoidal and comonoidal structures of the functor ϵ —namely, $\phi_0: F\top \rightarrow \tan F$ and $\psi_0: \tan F \rightarrow F\top$ —have the property that $\phi_0\psi_0 = t_{\tan F}$ and $\psi_0\phi_0 = F\top$; that is, we have witnessed $F\top$ as a splitting of $t_{\tan F}$. Recall from Section 2.2.1 that any such splitting $H \xrightarrow{\alpha} h \xrightarrow{\beta} H$ inherits a separable Frobenius structure from the bialgebra structure of H ; specifically:

$$\begin{aligned}
 \mu' &= h \otimes h \xrightarrow{\beta \otimes \beta} H \otimes H \xrightarrow{\mu} H \xrightarrow{\alpha} h \\
 \delta' &= h \xrightarrow{\beta} H \xrightarrow{\delta} H \otimes H \xrightarrow{\alpha \otimes \alpha} h \otimes h \\
 \epsilon' &= h \xrightarrow{\beta} H \xrightarrow{\epsilon} \top \\
 \eta' &= \top \xrightarrow{\eta} H \xrightarrow{\alpha} h
 \end{aligned}$$

We can calculate the explicit forms of this structure in the case where $(\alpha, \beta) = (\psi_0, \phi_0)$, to find that these four maps are given by:

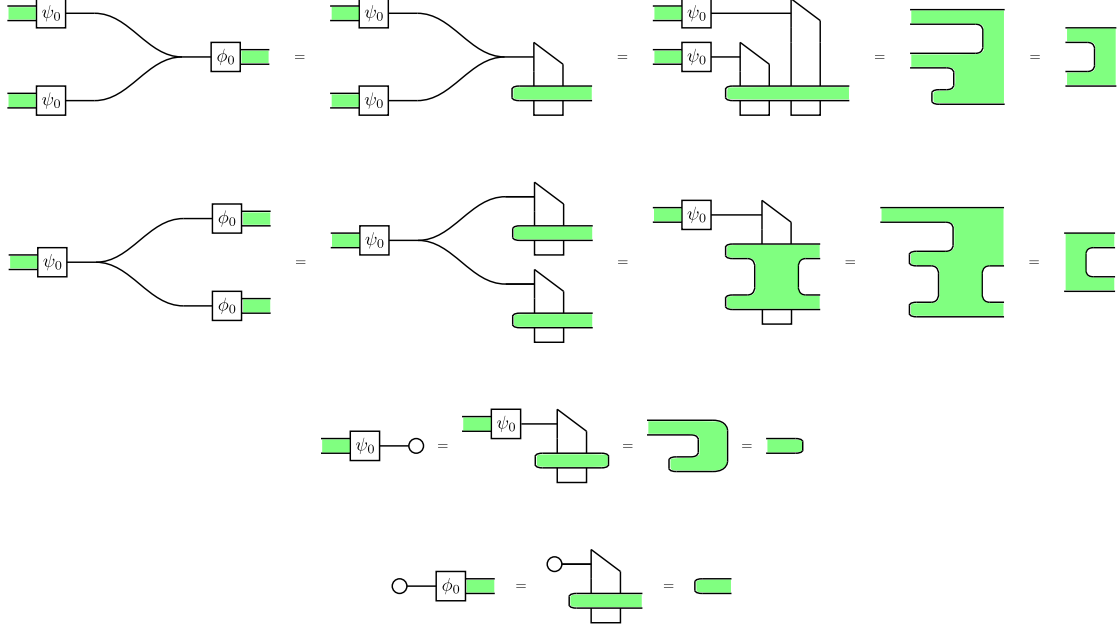

Trivially, \top bears a Frobenius algebra structure in A , hence, so too does its image $F\top$ under the separable Frobenius functor F . The above calculation proves a conjecture of Dimitri Chikhladze that these two Frobenius algebra structures on $F\top$ coincide.

7 Change of Base for the Tannaka Adjunction

We have seen that, for fixed \mathcal{V} , there is an adjunction:

$$\mathbf{sfmon} \downarrow \mathcal{V} \begin{array}{c} \xrightarrow{\text{tan}_{\mathcal{V}}} \\ \perp \\ \xleftarrow{\text{mod}_{\mathcal{V}}} \end{array} (\mathbf{wba} \mathcal{V})^{\text{op}}$$

Now let us consider what happens when we vary the base category \mathcal{V} . We must define a suitable category through which \mathcal{V} is to vary.

Definition 27. Denote by \mathbb{K} the 2-category whose objects are braided monoidally complete categories, whose arrows are separable Frobenius monoidal functors which are braided as monoidal functors and braided as comonoidal functors, and whose 2-cells are monoidal and comonoidal natural transformations.

Proposition 7. There is a 2-functor $\mathbf{sfmon} \downarrow - : \mathbb{K} \rightarrow \mathbf{Cat}$ whose value at a braided monoidally complete category \mathcal{V} is $\mathbf{sfmon} \downarrow \mathcal{V}$ as defined above.

Proof. For each object \mathcal{V} in \mathbb{K} , we define $\mathbf{sfmon} \downarrow \mathcal{V}$ as above, namely, to be the comma category of separable Frobenius monoidal functors of reconstruction type into \mathcal{V} with Frobenius monoidal functors between them. If $\Phi: \mathcal{V} \rightarrow \mathcal{W}$ is an arrow in \mathbb{K} , then composition with Φ defines a functor $\mathbf{sfmon} \downarrow \Phi: \mathbf{sfmon} \downarrow \mathcal{V} \rightarrow \mathbf{sfmon} \downarrow \mathcal{W}$, since the composition of a separable Frobenius monoidal functor of reconstruction type followed by an arbitrary separable Frobenius monoidal functor is again a separable Frobenius functor of reconstruction type. Similarly, given $\Phi, \Psi: \mathcal{V} \rightarrow \mathcal{W}$ and $\alpha: \Phi \Rightarrow \Psi$ in \mathbb{K} , then $\mathbf{sfmon} \downarrow \alpha: \mathbf{sfmon} \downarrow \Phi \rightarrow \mathbf{sfmon} \downarrow \Psi$ defines a natural transformation whose value at an object $F: A \rightarrow \mathcal{V}$ of $\mathbf{sfmon} \downarrow \mathcal{V}$ is α whiskered by F . Verification of the 2-functor axioms is routine. \square

We will require the following:

Lemma 1 (The Bow Lemma). If F is a Frobenius functor which is braided as a monoidal functor or braided as a comonoidal functor, then the following equation holds:

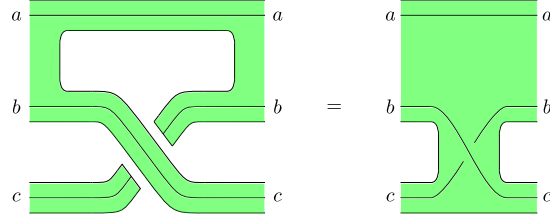

Proof. We present the case where F is known to be braided as a comonoidal functor; a dual proof can be obtained by taking horizontal flips of every step. Consider the following calculation:

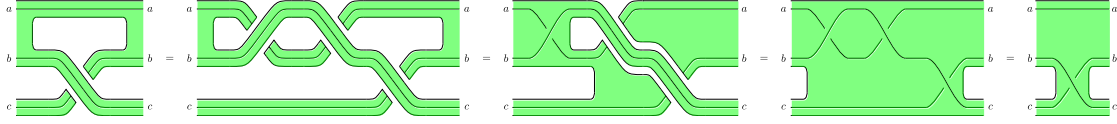

The first equality is simply the insertion of an isomorphism (in the codomain) and its inverse. The second equality uses the braidedness of the functor on the left and the naturality of the braid on the right. The third equality uses a Frobenius axiom followed by another instance of the braidedness of the functor. Finally, the last equality simply cancels out an isomorphism (in the domain) with its inverse. \square

Proposition 8. There is a 2-functor $\mathbf{wba} - : \mathbb{K} \rightarrow \mathbf{Cat}$ whose value at a braided monoidally complete category \mathcal{V} is $\mathbf{wba} \mathcal{V}$ as defined above.

Proof. Let $\Phi : \mathcal{V} \rightarrow \mathcal{W}$ be an arrow in \mathbb{K} . Define $\mathbf{wba} \Phi : \mathbf{wba} \mathcal{V} \rightarrow \mathbf{wba} \mathcal{W}$ as follows: Let $(B, \delta, \mu, \eta, \epsilon)$ be a weak bialgebra in $\mathbf{wba} \mathcal{V}$. Define $(\mathbf{wba} \Phi)B$ to be ΦB equipped with suitably conjugated versions of the structural maps of \mathcal{V} , this is again a weak bialgebra. To see that $(\mathbf{wba} \Phi)B$ satisfies the weak counit axioms, consider the following calculation:

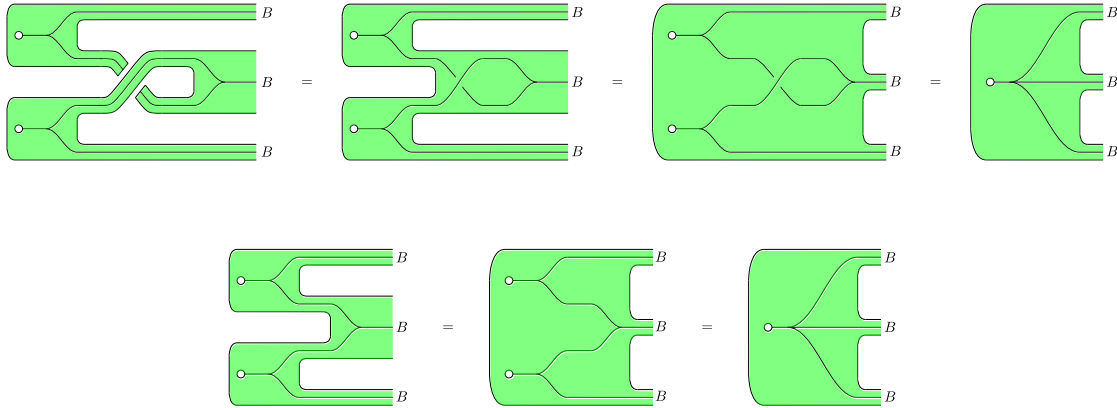

The first equality in the first line uses the fact that Φ is braided as a monoidal functor; after that, the equalities in both lines follow from the Frobenius axioms, followed by the weak bialgebra counit axioms in the domain. The weak unit axioms are satisfied by the horizontally flipped versions of the same calculations; this will use the fact that Φ is braided as a comonoidal functor.

Finally, we must verify the bialgebra axiom. To this end, consider the following:

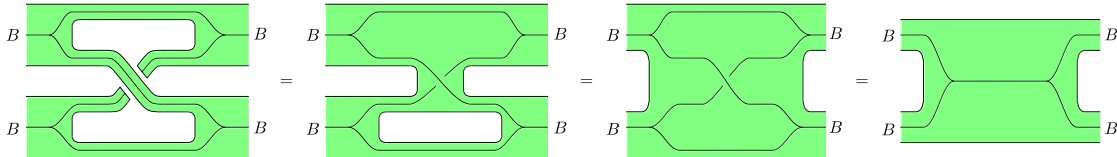

The first equality holds by the Bow Lemma, the second by both Frobenius axioms and separability of Φ , and the last by the bialgebra axiom in \mathcal{V} . Thus, $(\mathbf{wba}\ \Phi)B$ is a weak bialgebra as defined.

Let arrows $\Phi, \Psi: \mathcal{V} \rightarrow \mathcal{W}$ and 2-cell $\alpha: \Phi \Rightarrow \Psi$ in \mathbb{K} be given. Then define $\mathbf{wba}\ \alpha: \mathbf{wba}\ \Phi \Rightarrow \mathbf{wba}\ \Psi$ to be $\alpha B: \Phi B \rightarrow \Psi B$. Since α is monoidal and comonoidal, this defines a *strict* morphism of weak bialgebras, although we will not need this fact.

Verifying that $\mathbf{wba}\ -$ so defined satisfies the 2-functor axioms is straightforward. \square

With these definitions in hand, we can discuss the naturality of the Tannaka construction:

Proposition 9. There is a lax natural transformation $\tan -$ from $\mathbf{sfmon} \downarrow -$ to $(\mathbf{wba}\ -)^{\text{op}}$, whose value at a braided monoidally complete \mathcal{V} is the functor $\tan_{\mathcal{V}}: \mathbf{sfmon} \downarrow \mathcal{V} \rightarrow (\mathbf{wba}\ \mathcal{V})^{\text{op}}$ discussed above.

Proof. As promised, we define the 1-cells of the lax natural transformation $\tan -$ to be $\tan_{\mathcal{V}}$ for each object \mathcal{V} of \mathbb{K} . Given an arrow $\Phi: \mathcal{V} \rightarrow \mathcal{W}$ in \mathbb{K} , define the 2-cells of the lax natural transformation $\tan -$ to be $\rho\Phi$:

$$\begin{array}{ccc}
 \mathbf{sfmon} \downarrow \mathcal{V} & \xrightarrow{\tan_{\mathcal{V}}} & (\mathbf{wba}\ \mathcal{V})^{\text{op}} \\
 \downarrow \mathbf{sfmon} \downarrow \Phi & \nearrow \rho\Phi & \downarrow (\mathbf{wba}\ \Phi)^{\text{op}} \\
 \mathbf{sfmon} \downarrow \mathcal{W} & \xrightarrow{\tan_{\mathcal{W}}} & (\mathbf{wba}\ \mathcal{W})^{\text{op}}
 \end{array}$$

where $\rho\Phi$ is defined at an object $F \in \mathbf{sfmon} \downarrow \mathcal{V}$ as the morphism

$$\rho\Phi F: \Phi \tan F \rightarrow \tan \Phi F$$

in $(\mathbf{wba}\ \mathcal{W})^{\text{op}}$ corresponding to

$$\Phi \tan F \otimes \Phi F \xrightarrow{\varphi} \Phi(\tan F \otimes F) \xrightarrow{\Phi\alpha} \Phi F$$

Verifying that this is natural in F is a routine unravelling of the definitions of ρ and $\tan -$ on arrows.

We must show that $\rho\Phi$ so defined is a weak morphism of weak bialgebras. In fact, it is a *strong* morphism of weak bialgebras.

First, to see that $\rho\Phi$ preserves the unit, consider:

The equalities hold by: definition of ρ ; naturality and monoidality of the monoidal structure of Φ ; the definition of the unit of $\tan F$; and the definition of the unit of $\tan \Phi F$.

Second, to see that $\rho\Phi$ preserves the counit, consider:

The equalities hold by: definition of the counit of $\tan \Phi F$; definition of ρ ; naturality and monoidality of the monoidal structure of Φ ; and the definition of the counit of $\tan F$.

Third, to see that $\rho\Phi$ preserves the multiplication, consider:

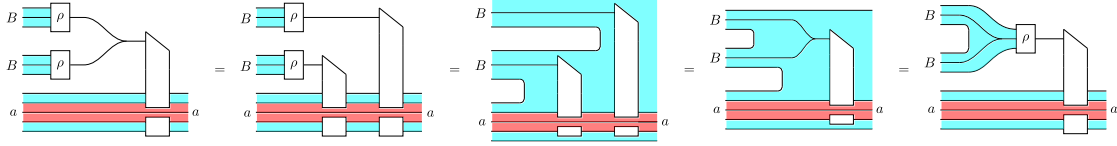

The equalities hold by: definition of the multiplication of $\tan \Phi F$; definition of ρ ; naturality and associativity of the monoidal structure of Φ ; and the definition of ρ once more.

Fourthly and finally, to see that $\rho\Phi$ preserves the comultiplication, see Figure 7

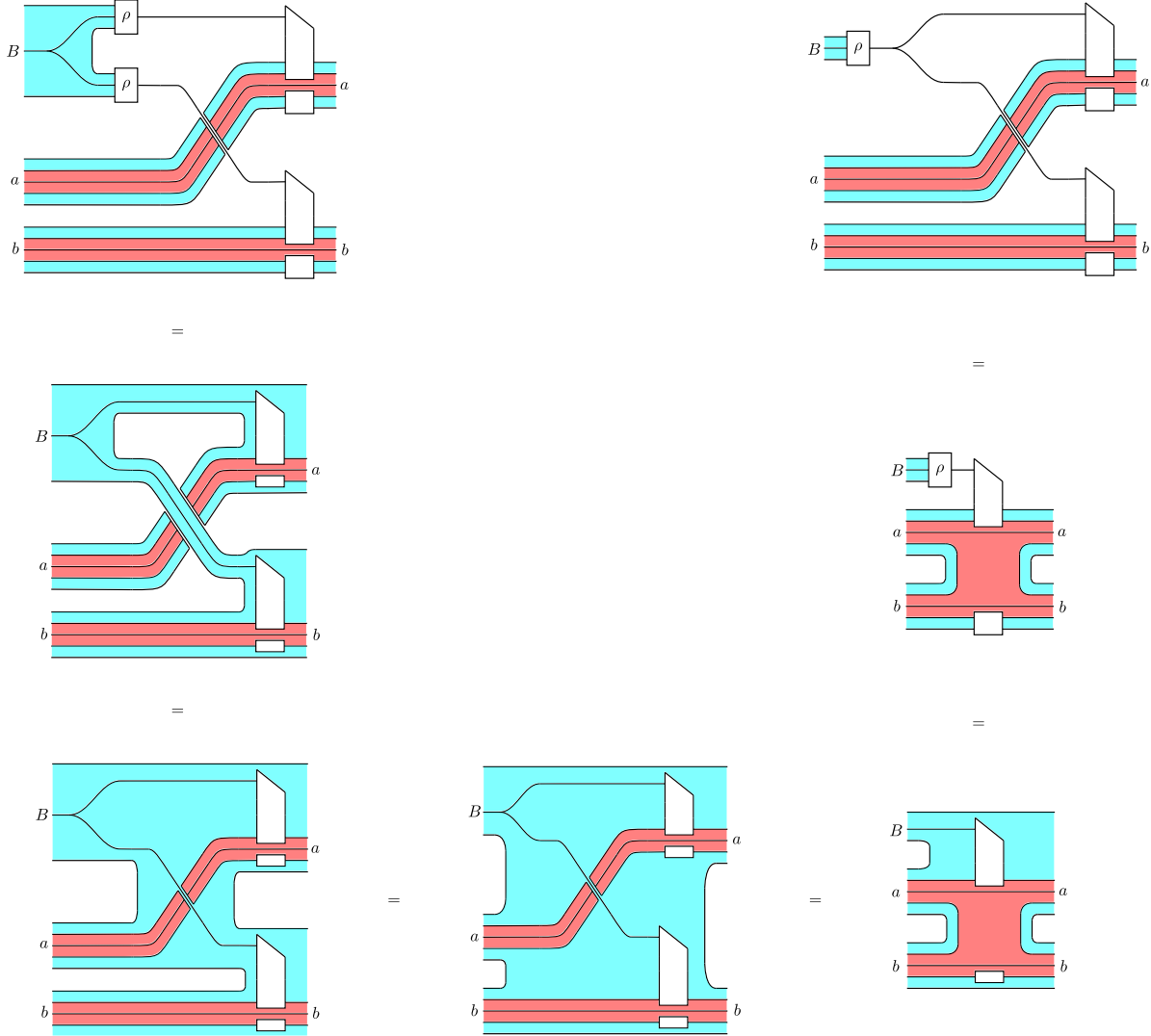

Figure 7: Preservation of comultiplication by $\rho\Phi$. Counterclockwise from top-left, the equalities hold by: definition of ρ ; the bow lemma for Φ ; Frobenius and associativity axioms for Φ ; the definition of the comultiplication of $\tan F$; the definition of ρ again; and, finally, the definition of the comultiplication of $\tan \Phi F$.

Verifying the lax natural transformation axioms is routine. \square

Since, for each \mathcal{V} , the functor $\tan_{\mathcal{V}}$ has a right adjoint, an application of ‘‘Australian mates’’ to this

lax natural transformation ρ yields an oplax natural transformation

$$\begin{array}{ccc}
 (\mathbf{wba} \mathcal{V})^{\text{op}} & \xrightarrow{\text{mod}_{\mathcal{V}}} & \mathbf{sfmon} \int \mathcal{V} \\
 \downarrow (\mathbf{wba} \Phi)^{\text{op}} & \swarrow \gamma \Phi & \downarrow \mathbf{sfmon} \int \Phi \\
 (\mathbf{wba} \mathcal{W})^{\text{op}} & \xrightarrow{\text{mod}_{\mathcal{W}}} & \mathbf{sfmon} \int \mathcal{W}
 \end{array}$$

Given a weak bialgebra B in \mathcal{V} , the behaviour of $\gamma: \text{mod}_{\mathcal{V}} B \rightarrow \text{mod}_{\mathcal{W}} \Phi B$ can be calculated as

$$\gamma \left(a, B \otimes a \xrightarrow{\beta} a, \nabla_a: a \rightarrow a \right) = \left(\Phi a, \Phi B \otimes \Phi a \xrightarrow{\varphi} \Phi(B \otimes a) \xrightarrow{\Phi\beta} \Phi a, \Phi \nabla_a \right)$$

References

- [Bic01] Julien Bichon. Cosovereign Hopf algebras. *J. Pure Appl. Algebra*, 157(2-3):121–133, 2001.
- [BNS99] Gabriella Böhm, Florian Nill, and Kornél Szlachányi. Weak Hopf algebras. I. Integral theory and C^* -structure. *J. Algebra*, 221(2):385–438, 1999.
- [BS00] Gabriella Böhm and Kornél Szlachányi. Weak Hopf algebras. II. Representation theory, dimensions, and the Markov trace. *J. Algebra*, 233(1):156–212, 2000.
- [CMZ97] S. Caenepeel, G. Militaru, and S. Zhu. Doi-Hopf modules, Yetter-Drinfel’d modules and Frobenius type properties. *Trans. Amer. Math. Soc.*, 349(11):4311–4342, 1997.
- [CS99] J. R. B. Cockett and R. A. G. Seely. Linearly distributive functors. *J. Pure Appl. Algebra*, 143(1-3):155–203, 1999. Special volume on the occasion of the 60th birthday of Professor Michael Barr (Montreal, QC, 1997).
- [Day96] Brian J. Day. Enriched Tannaka reconstruction. *J. Pure Appl. Algebra*, 108(1):17–22, 1996.
- [DP08] Brian Day and Craig Pastro. Note on Frobenius monoidal functors. *New York J. Math.*, 14:733–742, 2008.
- [Dri87] V. G. Drinfel’d. Quantum groups. In *Proceedings of the International Congress of Mathematicians, Vol. 1, 2 (Berkeley, Calif., 1986)*, pages 798–820, Providence, RI, 1987. Amer. Math. Soc.
- [Dri89] V. G. Drinfel’d. Quasi-Hopf algebras. *Algebra i Analiz*, 1(6):114–148, 1989.
- [Egg08] J. M. Egger. Star-autonomous functor categories. *Theory Appl. Categ.*, 20:No. 11, 307–333, 2008.
- [EM10] J. M. Egger and Micah Blake McCurdy. On cyclic star-autonomous categories. submitted, 2010.
- [HO97] Reinhard Häring-Oldenburg. Reconstruction of weak quasi Hopf algebras. *J. Algebra*, 194(1):14–35, 1997.
- [JS91] André Joyal and Ross Street. An introduction to Tannaka duality and quantum groups. In *Category theory (Como, 1990)*, volume 1488 of *Lecture Notes in Math.*, pages 413–492. Springer, Berlin, 1991.
- [Maj92] Shahn Majid. Tannaka-Kreĭn theorem for quasi-Hopf algebras and other results. In *Deformation theory and quantum groups with applications to mathematical physics (Amherst, MA, 1990)*, volume 134 of *Contemp. Math.*, pages 219–232. Amer. Math. Soc., Providence, RI, 1992.
- [Maj93] Shahn Majid. Braided groups. *J. Pure Appl. Algebra*, 86(2):187–221, 1993.

- [McC] Micah Blake McCurdy. Reconstruction of structured weak bialgebras and weak hopf algebras. In preparation.
- [McC00] Paddy McCrudden. Categories of representations of coalgebroids. *Adv. Math.*, 154(2):299–332, 2000.
- [McC02] Paddy McCrudden. Tannaka duality for Maschkean categories. *J. Pure Appl. Algebra*, 168(2-3):265–307, 2002. Category theory 1999 (Coimbra).
- [Mel06] Paul-André Melliès. Functorial boxes in string diagrams. In *Computer science logic*, volume 4207 of *Lecture Notes in Comput. Sci.*, pages 1–30. Springer, Berlin, 2006.
- [MS10] Micah Blake McCurdy and Ross Street. What separable Frobenius monoidal functors preserve. *Cah. Topol. Géom. Différ. Catég.*, 51(1):29–50, 2010.
- [Nil99] Florian Nill. Axioms for weak bialgebras. arXiv:math/9805104v1, 1999.
- [Pfe09] Hendryk Pfeiffer. Tannaka-Kreĭn reconstruction and a characterization of modular tensor categories. *J. Algebra*, 321(12):3714–3763, 2009.
- [PS09] Craig Pastro and Ross Street. Weak Hopf monoids in braided monoidal categories. *Algebra Number Theory*, 3(2):149–207, 2009.
- [RT90] N. Yu. Reshetikhin and V. G. Turaev. Ribbon graphs and their invariants derived from quantum groups. *Comm. Math. Phys.*, 127(1):1–26, 1990.
- [Sch92] Peter Schauenburg. *Tannaka duality for arbitrary Hopf algebras*, volume 66 of *Algebra Berichte [Algebra Reports]*. Verlag Reinhard Fischer, Munich, 1992.
- [Sch03] Peter Schauenburg. Weak Hopf algebras and quantum groupoids. In *Noncommutative geometry and quantum groups (Warsaw, 2001)*, volume 61 of *Banach Center Publ.*, pages 171–188. Polish Acad. Sci., Warsaw, 2003.
- [Sch09] Daniel Schäppi. Tannaka duality for comonoids in cosmoi. arXiv:0911.0977v1, 2009.
- [Str07] Ross Street. *Quantum groups*, volume 19 of *Australian Mathematical Society Lecture Series*. Cambridge University Press, Cambridge, 2007. A path to current algebra.
- [Szl03] Kornél Szlachányi. Galois actions by finite quantum groupoids. In *Locally compact quantum groups and groupoids (Strasbourg, 2002)*, volume 2 of *IRMA Lect. Math. Theor. Phys.*, pages 105–125. de Gruyter, Berlin, 2003.
- [Szl05] Kornél Szlachányi. Adjointable monoidal functors and quantum groupoids. In *Hopf algebras in noncommutative geometry and physics*, volume 239 of *Lecture Notes in Pure and Appl. Math.*, pages 291–307. Dekker, New York, 2005.
- [Tan38] Tadao Tannaka. Über den dualitätssatz der nichtkommutativen topologischen gruppen. *Tohoku Math. J. (1st)*, 45:1–12, 1938.
- [Ulb90] K.-H. Ulbrich. On Hopf algebras and rigid monoidal categories. *Israel J. Math.*, 72(1-2):252–256, 1990. Hopf algebras.