

# DEHN FILLINGS OF KNOT MANIFOLDS CONTAINING ESSENTIAL ONCE-PUNCTURED TORI

STEVEN BOYER, CAMERON MCA. GORDON, AND XINGRU ZHANG

November 13, 2018

**ABSTRACT.** In this paper we study exceptional Dehn fillings on hyperbolic knot manifolds which contain an essential once-punctured torus. Let  $M$  be such a knot manifold and let  $\beta$  be the boundary slope of such an essential once-punctured torus. We prove that if Dehn filling  $M$  with slope  $\alpha$  produces a Seifert fibred manifold, then  $\Delta(\alpha, \beta) \leq 5$ . Furthermore we classify the triples  $(M; \alpha, \beta)$  when  $\Delta(\alpha, \beta) \geq 4$ . More precisely, when  $\Delta(\alpha, \beta) = 5$ , then  $M$  is the (unique) manifold  $Wh(-3/2)$  obtained by Dehn filling one boundary component of the Whitehead link exterior with slope  $-3/2$ , and  $(\alpha, \beta)$  is the pair of slopes  $(-5, 0)$ . Further,  $\Delta(\alpha, \beta) = 4$  if and only if  $(M; \alpha, \beta)$  is the triple  $(Wh(\frac{-2n \pm 1}{n}); -4, 0)$  for some integer  $n$  with  $|n| > 1$ . Combining this with known results, we classify all hyperbolic knot manifolds  $M$  and pairs of slopes  $(\beta, \gamma)$  on  $\partial M$  where  $\beta$  is the boundary slope of an essential once-punctured torus in  $M$  and  $\gamma$  is an exceptional filling slope of distance 4 or more from  $\beta$ . Refined results in the special case of hyperbolic genus one knot exteriors in  $S^3$  are also given.

## 1. INTRODUCTION

This is the second of four papers in which we investigate the following conjecture of the second named author (see [Go2, Conjecture 3.4]). Recall that a *hyperbolic knot manifold* is a compact, connected, orientable 3-manifold with torus boundary whose interior admits a complete, finite volume hyperbolic structure.

**Conjecture 1.1.** (C. McA. Gordon) *Suppose that  $M$  is a hyperbolic knot manifold and  $\alpha, \beta$  are slopes on  $\partial M$  such that  $M(\alpha)$  is Seifert fibred and  $M(\beta)$  toroidal. If  $\Delta(\alpha, \beta) > 5$ , then  $M$  is the figure eight knot exterior.*

Our first result reduces the verification of the conjecture to the case where the Seifert filling is atoroidal.

**Theorem 1.2.** *Suppose that  $M$  is a hyperbolic knot manifold and  $\alpha, \beta$  are slopes on  $\partial M$  such that  $M(\alpha)$  is a toroidal Seifert fibred manifold and  $M(\beta)$  is toroidal. Then  $\Delta(\alpha, \beta) \leq 4$ . Furthermore, if  $\Delta(\alpha, \beta) = 4$  then  $(M; \alpha, \beta) \cong (N(-\frac{1}{2}, -\frac{1}{2}); -4, 0)$  where  $N$  is the exterior of the 3-chain link [MP].*

---

Steven Boyer was partially supported by NSERC grant RGPIN 9446-2008.

Cameron Gordon was partially supported by NSF grant DMS-0906276.

2000 MATHEMATICS SUBJECT CLASSIFICATION. PRIMARY 57M25, 57M50, 57M99

We have that  $N(-\frac{1}{2}, -\frac{1}{2}, -4)$  is Seifert fibred with base orbifold  $P^2(2, 3)$ , and  $N(-\frac{1}{2}, -\frac{1}{2}, 0)$  contains an incompressible torus separating  $N(-\frac{1}{2}, -\frac{1}{2}, 0)$  into Seifert fibred manifolds with base orbifolds  $D^2(2, 2)$  and  $D^2(2, 3)$ . (See [MP, Table 2].)

A *small Seifert* manifold is a 3-manifold which admits a Seifert structure with base orbifold of the form  $S^2(a, b, c)$  where  $a, b, c \geq 1$ . For instance, a closed, atoroidal Seifert manifold is small Seifert.

A small Seifert manifold is a *prism manifold* if its base orbifold is  $S^2(2, 2, n)$  for some  $n \geq 2$ .

Since the distance between a toroidal filling slope and a reducible filling slope is at most 3 ([Oh], [Wu1]), Theorem 1.2 reduces our analysis of Conjecture 1.1 to understanding the case where the Seifert Dehn filling is irreducible and small Seifert. In an earlier paper [BGZ2] we verified the conjecture in the case where  $M$  admits no essential punctured torus of boundary slope  $\beta$  which is a fibre or semi-fibre, or which has fewer than three boundary components; more precisely, we showed that in this case  $\Delta(\alpha, \beta) \leq 5$ . Here we focus on the case where  $M$  admits an essential punctured torus with one boundary component.

Let  $Wh$  denote the left-handed Whitehead link exterior (see Figure 33). We parameterise the slopes on a boundary component of  $Wh$  using the standard meridian-longitude coordinates.

**Theorem 1.3.** *Let  $M$  be a hyperbolic knot manifold and  $\alpha$  a slope on  $\partial M$  such that  $M(\alpha)$  is small Seifert. If  $M$  admits an essential, once-punctured torus  $F$  of boundary slope  $\beta$  then  $\Delta(\alpha, \beta) \leq 5$ . Further, if  $\Delta(\alpha, \beta) > 3$ , then  $F$  is not a fibre and  $\pi_1(M(\alpha))$  is finite. More precisely,*

- (1) *if  $\Delta(\alpha, \beta) = 4$ , then  $(M; \alpha, \beta) \cong (Wh(\frac{-2n \pm 1}{n}); -4, 0)$  for some integer  $n$  with  $|n| > 1$  and  $M(\alpha)$  has base orbifold  $S^2(2, 2, |\mp 2n - 1|)$ , so  $M(\alpha)$  is a prism manifold;*
- (2) *if  $\Delta(\alpha, \beta) = 5$ , then  $(M; \alpha, \beta) \cong (Wh(-3/2); -5, 0)$ , and  $M(\alpha)$  has base orbifold  $S^2(2, 3, 3)$ .*

Baker [Ba] has proven Theorem 1.3 in the case that  $M(\alpha)$  is a lens space. We provide an alternate proof of his result.

Theorem 1.3 is sharp; see the infinite family of examples in §11 for (1) and [MP, Table A.3] for (2). Another family of examples is provided by hyperbolic twist knots. These are genus one knots in the 3-sphere whose exteriors admit small Seifert filling slopes of distance 1, 2, and 3 from the longitudinal slope. Finally, Baker [Ba, Theorem 1.1(IV)] has constructed an infinite family of non-fibred hyperbolic knot manifolds which admit a once-punctured essential torus whose boundary slope is of distance 3 to a lens space filling slope.

Here is an outline of the proof of Theorem 1.3. We begin by showing that the result holds unless, perhaps,  $M$  admits an orientation-preserving involution  $\tau$  with non-empty branch set  $L$  contained in the interior of the quotient  $M/\tau$ , which is a solid torus. The results of [BGZ2] reduce us to the case that  $L$  has a very particular form (see Figure 3). On the other hand,  $\tau$  extends to an involution  $\tau_\alpha$  of  $M(\alpha)$  with branch set  $L_\alpha$  contained in the lens space  $M(\alpha)/\tau_\alpha$ . The fundamental group of  $M(\alpha)/\tau_\alpha$  is non-trivial if the distance between  $\alpha$  and  $\beta$  is at least 3. Since the involutions on small Seifert manifolds with such quotients are well-understood, we

can explicitly describe the branch set  $L_\alpha$  of  $\tau_\alpha$ . Comparing this description with the constraints we have already deduced on  $L$  leads to the proof of the theorem.

Recall that an *exceptional filling slope* on the boundary of a hyperbolic 3-manifold is a slope  $\gamma$  such that  $M(\gamma)$  is not hyperbolic. Geometrisation of 3-manifolds implies that a slope  $\gamma$  is exceptional if and only if  $M(\gamma)$  is either reducible, toroidal, or Seifert fibred. Theorem 1.3 combines with [Oh], [Wu1], [Go1], [GW], and Proposition 3.1 to yield the next result.

**Theorem 1.4.** *Let  $M$  be a hyperbolic knot manifold which admits an essential, once-punctured torus  $F$  of boundary slope  $\beta$  and let  $\gamma$  be an exceptional filling slope on  $\partial M$ .*

- (1)  $\Delta(\gamma, \beta) \leq 7$ .
- (2) If  $\Delta(\gamma, \beta) > 3$ , then  $M(\gamma)$  is either toroidal or has a finite fundamental group.
- (3) If  $\Delta(\gamma, \beta) > 3$  and  $M(\gamma)$  is toroidal, then either
  - (a)  $\Delta(\gamma, \beta) = 4$  and  $(M; \gamma, \beta) \cong (Wh(\delta); -4, 0)$  for some slope  $\delta$ ; or
  - (b)  $\Delta(\gamma, \beta) = 5$  and  $(M; \gamma, \beta) \cong (Wh(-4/3); -5, 0)$  or  $(Wh(-7/2); -5/2, 0)$ ; or
  - (c)  $\Delta(\gamma, \beta) = 7$  and  $(M; \gamma, \beta) \cong (Wh(-5/2); -7/2, 0)$ .
- (4) If  $\Delta(\gamma, \beta) > 3$  and  $\pi_1(M(\gamma))$  is finite, then either
  - (a)  $\Delta(\gamma, \beta) = 4$ ,  $(M; \gamma, \beta) \cong (Wh(\frac{-2n \pm 1}{n}); -4, 0)$  for some integer  $n$  with  $|n| > 1$ , and  $M(\gamma)$  has base orbifold  $S^2(2, 2, |\mp 2n - 1|)$ ; or
  - (b)  $\Delta(\gamma, \beta) = 5$ ,  $(M; \gamma, \beta) \cong (Wh(-3/2); -5, 0)$ , and  $M(\gamma)$  has base orbifold  $S^2(2, 3, 3)$ .

Next we specialize to the case where  $M$  is the exterior of a hyperbolic knot in the 3-sphere.

**Theorem 1.5.** *Let  $K \subset S^3$  be a hyperbolic knot of genus one with exterior  $M_K$  and suppose  $p/q$  is an exceptional filling slope on  $\partial M_K$ .*

- (1)  $M_K(0)$  is toroidal but not Seifert.
- (2)  $M_K(p/q)$  is either toroidal or small Seifert with hyperbolic base orbifold.
- (3) If  $M_K(p/q)$  is small Seifert with hyperbolic base orbifold, then  $0 < |p| \leq 3$ .
- (4) If  $M_K(p/q)$  is toroidal, then  $|q| = 1$  and  $|p| \leq 4$  with equality implying  $K$  is a twist knot.

Here is how the paper is organised. We prove Theorem 1.2 in §2. In §3 we show that there are strong topological constraints on  $M$  which must be satisfied if Theorem 1.3 doesn't hold. These constraints will be applied later in the paper to construct an involution on  $M$ . In §4 we describe the branching set of an orientation-preserving involution on a small Seifert manifold with quotient space a lens space with non-trivial fundamental group. Using this we reduce the proof of Theorem 1.3 to five problems involving links in lens spaces in §5, and a problem in which  $\Delta(\alpha, \beta) = 4$  and  $M(\alpha)$  is a prism manifold. These problems are resolved in §6, §7, §8, §9, §10 and §12 respectively. The infinite family of examples realising distance 4 in Theorem 1.3 is constructed in §11. Theorems 1.4 and 1.5 are dealt with in §13.

## 2. THE CASE WHERE $M(\alpha)$ IS TOROIDAL

In this section we prove Theorem 1.2. Recall from the introduction that  $N$  denotes the exterior of the 3-chain link of [MP]. Note that  $N(-\frac{1}{2}, -\frac{1}{2})$  is obtained by Dehn filling on  $N(-\frac{1}{2})$ , which is the exterior of the rational link associated with the rational number  $10/3$ .

To prove Theorem 1.2 we consider all  $(M; \alpha, \beta)$  where  $M$  is hyperbolic,  $M(\alpha)$  and  $M(\beta)$  are toroidal and  $\Delta(\alpha, \beta) \geq 4$ . For  $\Delta(\alpha, \beta) \geq 6$  there are only four such  $(M; \alpha, \beta)$  [Gol], and in all four cases neither  $M(\alpha)$  nor  $M(\beta)$  is Seifert fibred.

For  $\Delta(\alpha, \beta) = 4$  or  $5$ , the triples  $(M; \alpha, \beta)$  are determined in [GW]: there are 14 hyperbolic manifolds  $M_i$ ,  $1 \leq i \leq 14$ , each with a pair of toroidal filling slopes  $\alpha_i, \beta_i$  at distance 4 or 5, where  $M_1, M_2, M_3$  and  $M_{14}$  have two (torus) boundary components, and the others, one. It is shown in [GW] that a hyperbolic manifold  $M$  has two toroidal filling slopes  $\alpha$  and  $\beta$  at distance 4 or 5 if and only if  $(M; \alpha, \beta) \cong (M_i; \alpha_i, \beta_i)$  for some  $1 \leq i \leq 14$ , or  $(M; \alpha, \beta) \cong (M_i(\gamma); \alpha_i, \beta_i)$  for  $i = 1, 2, 3$  or  $14$  and some slope  $\gamma$  on the second boundary component of  $M_i$ . (We adopt the convention that in the above homeomorphisms either  $\alpha \mapsto \alpha_i, \beta \mapsto \beta_i$ , or  $\alpha \mapsto \beta_i, \beta \mapsto \alpha_i$ .) We prove Theorem 1.2 by showing that firstly, for  $i \neq 1, 2, 3$  or  $14$ , neither of the toroidal manifolds  $M_i(\alpha_i)$  or  $M_i(\beta_i)$  is Seifert fibred, secondly, for  $i = 1, 3$  or  $14$ , there is no hyperbolic manifold of the form  $M_i(\gamma)$  with either  $M_i(\gamma)(\alpha_i)$  or  $M_i(\gamma)(\beta_i)$  toroidal Seifert fibred, and thirdly, there is a unique example  $(M_2(\gamma); \alpha_2, \beta_2)$  (up to homeomorphism) where  $M_2(\gamma)$  is hyperbolic,  $M_2(\gamma)(\alpha_2)$  and  $M_2(\gamma)(\beta_2)$  are toroidal, and one is Seifert fibred; this is the example described in Theorem 1.2.

We first consider the manifolds  $M_i$ ,  $6 \leq i \leq 13$ . The toroidal fillings on  $M_i$ ,  $M_i(0)$  and  $M_i(\beta_i)$ , are described in Lemma 22.2 of [GW]. We adopt the notation introduced in [GW, p.116].

**Lemma 2.1.** *For  $6 \leq i \leq 13$ ,  $M_i(0)$  is not Seifert fibred.*

*Proof.*  $M_i(0)$  is of the form  $X(p_1, q_1; p_2, q_2)$ ; it is the double branched cover of the tangle  $Q_i(0)$ , which is of the form  $T(p_1, q_1; p_2, q_2)$ , the union of two Montesinos tangles. Assume the numbering is chosen so that  $p_1, q_1$  are not both 2; (actually this is only an issue when  $i = 8$ ). Then the Seifert fibre  $\varphi_1$  of  $X(p_1, q_1)$  is unique. Since  $X(p_1, q_1)$  and  $X(p_2, q_2)$  are not both twisted  $I$ -bundles, to show that  $M_i(0)$  is not Seifert fibred it suffices to show that, in the gluing of  $X(p_1, q_1)$  and  $X(p_2, q_2)$ ,  $\varphi_1$  is not identified with the Seifert fibre  $\varphi_2$  of  $X(p_2, q_2)$ . (When  $i = 8$ ,  $p_2 = q_2 = 2$  and there are two possible choices for  $\varphi_2$ .) We do this by identifying the image of  $\varphi_1$  in the boundary of the tangle  $T(p_1, q_1)$ , and then capping off the tangle  $T(p_2, q_2)$  with the corresponding rational tangle; in the double branched cover this corresponds to doing Dehn filling on  $X(p_2, q_2)$  along the slope  $\varphi_1$ . If  $M_i(0)$  were Seifert fibred then this Dehn filling would be reducible, and so the corresponding rational tangle filling on  $T(p_2, q_2)$  would give a link that is either composite or split. One checks that this is not the case.  $\diamond$

**Lemma 2.2.** *For  $6 \leq i \leq 13$ ,  $M_i(\beta_i)$  is not Seifert fibred.*

*Proof.* First note that  $M_7(\beta_7)$  is of the form  $X(2, 3; 2, 2)$ . We check that this is not Seifert fibred in the same way as we did for  $M_8(0)$  in Lemma 2.1.

When  $i \neq 7$ ,  $M_i(\beta_i)$  is the double branched cover of a 2-component link  $L_i$ ; see [GW, Lemma 22.2]. More specifically, for  $i = 6, 8, 9$  or  $12$ ,  $L_i$  is a cabled Hopf link  $C(p_1, q_1; p_2, q_2)$  with  $p_1, p_2 > 1$ , for  $i = 10$  or  $11$ ,  $L_i$  is the link  $C(C; 2, 1)$  (see [GW, page 116]), and for  $i = 13$ ,  $L_i$  is the 2-string cable of the trefoil shown in [GW, Figure 22.13(d)]. In all cases,  $L_i$  is *toroidal*, i.e. its exterior

contains an essential torus. Moreover the exterior of  $L_i$  is not Seifert fibred. Therefore if  $M_i(\beta_i)$  were Seifert fibred then  $L_i$  would be a Montesinos link. But the only toroidal Montesinos links are (see [Oe, Corollary 5])  $K(\frac{1}{2}, \frac{1}{2}, -\frac{1}{2}, -\frac{1}{2})$ ,  $K(\frac{2}{3}, -\frac{1}{3}, -\frac{1}{3})$ ,  $K(\frac{1}{2}, -\frac{1}{4}, -\frac{1}{4})$ , and  $K(\frac{1}{2}, -\frac{1}{3}, -\frac{1}{6})$ . One easily checks that no  $L_i$  is of this form.  $\diamond$

**Lemma 2.3.**  $M_4(\alpha_4)$  and  $M_4(\beta_4)$  are not Seifert fibred.

*Proof.*  $M_4(\alpha_4)$  and  $M_4(\beta_4)$  contain incompressible tori  $\widehat{F}_a$  and  $\widehat{F}_b$ ; the corresponding punctured tori  $F_a$  and  $F_b$  in  $M_4$  have four and two boundary components, respectively. The intersection of  $F_a$  and  $F_b$  is described by the intersection graphs  $\Gamma_a \subset \widehat{F}_a$  and  $\Gamma_b \subset \widehat{F}_b$  depicted in Figures 11.9(a) and (b) of [GW], respectively. Note that  $\widehat{F}_a$  separates  $M_4(\alpha_4)$ , into  $M_B$  and  $M_W$ , say, while  $\widehat{F}_b$  is non-separating in  $M_4(\beta_4)$ . The faces of the graph  $\Gamma_b$  lie alternately in  $M_B$  and  $M_W$ ; we choose the notation so that all the faces of  $\Gamma_b$  that lie in  $M_B$  are bigons.

Let  $f_1, f_2, f_3$ , and  $g_1, g_2, g_3$  be the faces of  $\Gamma_b$  with edges  $G, H; J, K; A, B$ ; and  $D, E; K, P, R; A, G, L$ ; respectively. Let  $h_1, h_2, h_3$  be the faces of  $\Gamma_a$  with edges  $E, N; H, E$ ; and  $B, G, N, R$ ; respectively. (The notation refers to the edges illustrated in Figure 11.9 of [GW].)

For computations in  $\pi_1(M_B)$  and  $\pi_1(M_W)$  we take as “base-point” the rectangle in  $\widehat{F}_a$  shown in Figure 11.9(a) of [GW]. Let  $s, t$  be the pair of generators of  $\pi_1(\widehat{F}_a)$  determined by the downward vertical and rightward horizontal edges of that rectangle, respectively. Let  $x_1$  and  $x_3$  be the elements of  $\pi_1(M_B)$  corresponding to the 1-handles  $H_{(12)}$  and  $H_{(34)}$ , in the usual way. The faces  $f_1, f_2$  and  $f_3$  give the relations in  $\pi_1(M_B)$ :

$$\begin{aligned} x_1^2 t &= 1 \\ x_3^2 t^{-1} &= 1 \\ s^{-1} x_3 x_1 &= 1 \end{aligned}$$

It follows that  $M_B$  is Seifert fibred with base orbifold  $D^2(2, 2)$ , and that the classes in  $\pi_1(\widehat{F}_a)$  of the Seifert fibres in the two Seifert fibrings of  $M_B$  are  $t$  and  $s$ .

Let  $x_2$  and  $x_4$  be the elements of  $\pi_1(M_W)$  corresponding to  $H_{(23)}$  and  $H_{(41)}$ . Then the faces  $g_1, g_2$  and  $g_3$  give the relations in  $\pi_1(M_W)$ :

$$\begin{aligned} t x_4 x_2 &= 1 \\ x_2 x_4 t^{-1} x_2 s t &= 1 \\ x_2 x_4^2 t^{-1} &= 1 \end{aligned}$$

These show that  $M_W$  is Seifert fibred with base orbifold  $D^2(2, 3)$ , the class of the Seifert fibre in  $\pi_1(\widehat{F}_a)$  being  $st^2$ . Since this is distinct from either of the Seifert fibres of  $M_B$ ,  $M_4(\alpha_4)$  is not Seifert fibred.

We now consider  $M_4(\beta_4)$ . Let  $u, v$  be the pair of generators for  $\pi_1(\widehat{F}_b)$  given by the downward vertical and leftward horizontal edges of the rectangle in Figure 11.9(b) of [GW]. (We take this rectangle as “base-point” for computations in  $\pi_1(M_4(\beta_4))$ .) Let  $x, y$  be the elements of

$\pi_1(M_4(\beta_4))$  given by the 1-handles  $H_{(12)}$  and  $H_{(21)}$ . The faces  $h_1, h_2, h_3$  give the relations in  $\pi_1(M_4(\beta_4))$ :

$$\begin{aligned} x(uv)y^{-1}v^{-1} &= 1 \\ yvx^{-1} &= 1 \\ x^{-1}u^{-1}xux^{-1}(vu)^{-1}y &= 1 \end{aligned}$$

The second relation gives  $x = yv$ , and the first then gives

$$y^{-1}vy = uv^2$$

The third relation gives

$$(y^{-1}u^{-1}y)u(y^{-1}u^{-1}y)u^{-1}v^{-3} = 1$$

Now if  $M_4(\beta_4)$  were Seifert fibred, the non-separating torus  $\widehat{F}_b$  would be horizontal and so  $M_4(\beta_4)$  would be a torus bundle over the circle with fibre  $\widehat{F}_b$ . Hence  $y^{-1}u^{-1}y$  would belong to  $\pi_1(\widehat{F}_b)$ . But the last relation above shows that if this is the case then

$$(y^{-1}u^{-1}y)^2 = v^3$$

Since  $v^3$  is not a square in  $\pi_1(\widehat{F}_b)$ , this is a contradiction.  $\diamond$

**Lemma 2.4.**  $M_5(\alpha_5)$  and  $M_5(\beta_5)$  are not Seifert fibred.

*Proof.* This can be proved in a similar fashion to Lemma 2.3, using [GW, Figure 11.10]. Another way to establish the result is to note that, according to [L2, §6],  $M_5 \cong N(1, -\frac{1}{3})$ , the toroidal filling slopes  $\alpha_5, \beta_5$  being  $-4$  and  $1$ . We see that  $N(1, -\frac{1}{3}, -4)$  and  $N(1, -\frac{1}{3}, 1)$  are not Seifert fibred from Tables 4 and 3 of [MP], respectively.  $\diamond$

We next consider the manifolds  $M_1, M_2$  and  $M_3$ , namely the exteriors of the Whitehead link, the  $10/3$ -rational link, and the Whitehead sister (or  $(-2, 3, 8)$ -pretzel) link, respectively. These are all obtained by Dehn filling on the 3-chain link:  $M_1 \cong N(1)$ ,  $M_2 \cong N(-\frac{1}{2})$ ,  $M_3 \cong N(-4)$ . Furthermore, their exceptional slopes and toroidal slopes are as follows (see [MP, Table A.1]):

	exceptional slopes	toroidal slopes
$N(1)$	$\infty, -3, -2, -1, 0, 1$	$-3, 1$
$N(-\frac{1}{2})$	$\infty, -4, -3, -2, -1, 0$	$-4, 0$
$N(-4)$	$\infty, -3, -2, -1, -\frac{1}{2}, 0$	$-\frac{1}{2}, 0$

**Lemma 2.5.** In each of the following cases, the manifold  $N(\alpha, \beta, \gamma)$  is a toroidal Seifert fibre space if and only if  $\gamma$  is one of the values listed.

- (a)  $N(1, -3, \gamma)$  :  $\gamma = -3, 1$ ;  
 $N(1, 1, \gamma)$  :  $\gamma = -3, -2, -1, 0$ .
- (b)  $N(-\frac{1}{2}, -4, \gamma)$  :  $\gamma = -\frac{1}{2}$ ;  
 $N(-\frac{1}{2}, 0, \gamma)$  :  $\gamma = -\frac{7}{2}$ .

- (c)  $N(-4, -\frac{1}{2}, \gamma) : \gamma = -\frac{1}{2};$   
 $N(-4, 0, \gamma) : \text{no } \gamma.$

*Proof.* This follows by inspecting Tables 2, 3 and 4 of [MP]. We see from these that the only toroidal Seifert fibre spaces  $N(\alpha, \beta, \gamma)$  are

- (1)  $N(-3, 1, 1), N(-3, -\frac{5}{3}, -\frac{5}{3}), N(-3, -3, t/u)$  where  $t/u \neq -1, -1 + \frac{1}{m}$  or  $\infty$ , and  
 (2)  $N(0, \frac{1}{2} + n, -\frac{9}{2} - n), N(1, 1, n)$  where  $|n + 1| \leq 1, N(-\frac{3}{2}, -\frac{5}{2}, 0)$ , and  $N(-4, -\frac{1}{2}, -\frac{1}{2})$ .  $\diamond$

Note that the values of  $\gamma$  listed in parts (a) and (c) of Lemma 2.5 all belong to the set of exceptional slopes of  $N(1)$  and  $N(-4)$  respectively. It follows that for  $i = 1$  and 3, there is no  $\gamma$  such that  $M_i(\gamma)$  is hyperbolic and one of  $M_i(\gamma)(\alpha_i), M_i(\gamma)(\beta_i)$  is toroidal Seifert fibred.

In the case  $i = 2$ , note that by [MP, Proposition 1.5 part (1.4)], there is an automorphism of  $N(-\frac{1}{2})$  inducing homeomorphisms

$$N(-\frac{1}{2}, -4, -\frac{1}{2}) \cong N(-\frac{1}{2}, 0, -\frac{7}{2})$$

$$N(-\frac{1}{2}, 0, -\frac{1}{2}) \cong N(-\frac{1}{2}, -4, -\frac{7}{2})$$

Also, we see from [MP, Table 2] that  $N(-\frac{1}{2}, 0, -\frac{1}{2})$  is toroidal. Thus part (b) of Lemma 2.5 gives rise to the single example described in Theorem 1.2.

Finally, we take care of  $M_{14}$ :

**Lemma 2.6.** *For no slope  $\gamma$  on the second boundary component of  $M_{14}$  is  $M_{14}(\gamma)(\alpha_{14})$  or  $M_{14}(\gamma)(\beta_{14})$  toroidal Seifert fibred.*

*Proof.* In [L1] Lee describes a hyperbolic 3-manifold  $Y$  with two torus boundary components having (homeomorphic) Dehn fillings  $Y(0)$  and  $Y(4)$  that contain Klein bottles. In fact  $Y(0) \cong Y(4) \cong Q(2, 2) \cup Wh$ , where  $Q(2, 2)$  is the Seifert fibre space with base orbifold  $D^2(2, 2)$  and  $Wh$  is the exterior of the Whitehead link. Hence  $Y(0) \cong Y(4)$  is toroidal. It follows from the classification in [GW] of the hyperbolic 3-manifolds with toroidal fillings at distance 4 that  $Y \cong M_{14}$ . (The only other manifolds with two boundary components having toroidal fillings at distance 4 are  $M_1$  and  $M_2$ , and there the toroidal fillings are graph manifolds; see e.g. [MP, Table A.1].) It therefore suffices to show that  $M_{14}(\gamma)(\alpha_{14})$  is not toroidal Seifert fibred for any slope  $\gamma$ .

The manifold  $M = M_{14}(\alpha_{14}) \cong Q(2, 2) \cup Wh$  is the double branched cover of the tangle shown in [GW, Figure 22.14(b)]. Thus  $M(\gamma) \cong Q(2, 2) \cup Wh(\gamma)$ . Hence if  $M(\gamma)$  is toroidal Seifert fibred then  $\gamma$  must be an exceptional slope for  $Wh$ . These slopes (with respect to the parametrization in [MP, Table A.1]) are  $\infty, -3, -2, -1, 0$  and 1. Now  $Wh(-3)$  and  $Wh(1)$  are toroidal non-Seifert,  $Wh(\infty) \cong D^2 \times S^1$ , and  $Wh(-2), Wh(-1)$  and  $Wh(0)$  are Seifert fibred with base orbifold  $D^2(3, 3), D^2(2, 4)$  and  $D^2(2, 3)$ , respectively. So we need only consider  $M(\gamma)$  for  $\gamma = \infty, -2, -1$  and 0; we do this by examining the corresponding rational tangle filling on the tangle shown in [GW, Figure 22.14(b)]. For  $\gamma = \infty$ , this yields the pretzel knot

$K(-\frac{1}{2}, -\frac{1}{2}, \frac{1}{2})$ , so  $M(\infty)$  is atoroidal. For  $\gamma = -2, -1$  and  $0$  we show that the Seifert fibre of  $Wh(\gamma)$  does not match the Seifert fibre in either of the two Seifert fibrings of  $Q(2, 2)$ . This is straightforward to check, for example using the same approach as in the proof of Lemma 2.1.  $\diamond$

### 3. BACKGROUND RESULTS FOR THE PROOF OF THEOREM 1.3

We collect various results in this section and the next which will be used throughout this paper and its sequel [BGZ3]. In what follows,  $M$  will be a hyperbolic knot manifold and  $b_1(M)$  will denote its first Betti number. In this section we assume that  $F$  is an essential, punctured torus of slope  $\beta$  which is properly embedded in  $M$ .

For a closed, essential surface  $S$  in  $M$  we define  $\mathcal{C}(S)$  to be the set of slopes  $\delta$  on  $\partial M$  such that  $S$  compresses in  $M(\delta)$ . A slope  $\eta$  on  $\partial M$  is called a *singular slope* for  $S$  if  $\eta \in \mathcal{C}(S)$  and  $\Delta(\delta, \eta) \leq 1$  for each  $\delta \in \mathcal{C}(S)$ . A result of Wu [Wu2] states that if  $\mathcal{C}(S) \neq \emptyset$ , then there is at least one singular slope for  $S$ .

**Proposition 3.1.** *Suppose that  $M$  admits a non-separating, essential, genus 1 surface of boundary slope  $\beta$  which caps-off to a compressible torus in  $M(\beta)$ . If  $\gamma$  is a slope on  $\partial M$  such that  $M(\gamma)$  is not hyperbolic, then  $\Delta(\gamma, \beta) \leq 3$ . If  $M(\gamma)$  is an irreducible, atoroidal, small Seifert manifold, then  $\Delta(\gamma, \beta) \leq 1$ .*

*Proof.* By hypothesis  $M(\beta)$  admits a non-separating 2-sphere and so is reducible with first Betti number at least 1. In the case that  $b_1(M) \geq 2$ , there is a closed essential surface  $S \subset \text{int}(M)$  which is Thurston norm minimizing in  $H_2(M)$ . By [Ga, Corollary],  $S$  is essential and Thurston norm minimizing in  $H_2(M(\delta))$  for all slopes  $\delta \neq \beta$ . By [BGZ1, Proposition 5.1],  $\Delta(\gamma, \beta) \leq 1$  for any slope  $\gamma$  such that  $M(\gamma)$  is not hyperbolic. Suppose then that  $b_1(M) = 1$  and note that by hypothesis  $\beta$  is a strict boundary slope. In this case [BCSZ2, Theorem 3.2] implies that  $\beta$  is a singular slope and so the conclusions of the lemma follow from [BGZ1, Theorem 1.5].  $\diamond$

**Corollary 3.2.** *Theorem 1.3 holds if  $M$  admits a non-separating, essential, genus 1 surface of boundary slope  $\beta$  which caps-off to a compressible torus in  $M(\beta)$ .  $\diamond$*

The torus in  $M(\beta)$  obtained by capping-off  $F$  with a meridional disks will be denoted  $\widehat{F}$ . We use  $M_F$  to denote the compact manifold obtained by cutting  $M$  open along  $F$  and  $M(\beta)_{\widehat{F}}$  the manifold obtained by cutting  $M(\beta)$  open along  $\widehat{F}$ .

**Proposition 3.3.** *Suppose that  $M(\alpha)$  is a Seifert fibred manifold and  $M(\beta)$  is toroidal. Then  $\Delta(\alpha, \beta) \leq 3$  as long as one of the following conditions is satisfied:*

- (a)  $\alpha$  or  $\beta$  is a singular slope of a closed essential surface in  $M$ .
- (b)  $M(\alpha)$  or  $M(\beta)$  is reducible.
- (c) (i)  $|\partial F| = 1$  and  $M_F$  is not a genus 2 handlebody.  
 (ii)  $|\partial F| = 2$  and  $M_F$  is neither connected nor a union of two genus 2 handlebodies.



*Proof.* If  $\alpha$  or  $\beta$  is a singular slope of a closed essential surface in  $M$ , then [BGZ1, Corollary 1.6] shows that  $\Delta(\alpha, \beta) \leq 3$ , so we are done in case (a).

Assume next that  $M(\gamma)$  is reducible where  $\gamma$  is one of  $\alpha$  or  $\beta$ . If  $\gamma = \alpha$ , then  $\Delta(\alpha, \beta) \leq 3$  by [Oh] and [Wu1]. Assume then that  $\gamma = \beta$ . If  $b_1(M) \geq 2$ , then  $\Delta(\gamma, \beta) \leq 1$  for any exceptional slope  $\gamma$  as in the proof of Proposition 3.1. Assume then that  $b_1(M) = 1$ . Since  $M(\beta)$  is toroidal, it is neither  $S^1 \times S^2$  nor a connected sum of lens spaces. Hence [BGZ1, Proposition 6.2] implies that  $\beta$  is a singular slope of a closed essential surface in  $M$ . Thus we are done by part (a).

Finally consider part (c) of the proposition. If  $|\partial F| = 1$ , any compression of  $\partial M_F$  in  $M_F$  yields one or two tori, so as  $M$  is hyperbolic it is not hard to see that  $M_F$  is a handlebody, contrary to hypothesis. Thus  $\partial M_F$  is incompressible in  $M_F$ , and hence in  $M$ . Let  $S \subset \text{int}(M)$  be the inner boundary component of a collar of  $\partial M_F$  in  $M_F$ . Then  $S$  is incompressible in  $M$ , and by construction there is an annulus  $A$  in  $M$  with boundary components  $\partial_1 A$  and  $\partial_2 A$ , say, where  $A \cap S = \partial_1 A$  and  $A \cap \partial M = \partial_2 A$  has slope  $\beta$  on  $\partial M$ . It follows from [Sh] that  $S$  is incompressible in  $M(\gamma)$  whenever  $\Delta(\gamma, \beta) > 1$ . Thus  $\beta$  is a singular slope for  $S$  and so part (a) of this proposition shows  $\Delta(\alpha, \beta) \leq 3$ . Thus (i) holds.

If  $|\partial F| = 2$  and  $M_F$  is not connected, then  $M = X_1 \cup_F X_2$  where  $\partial X_j$  is a genus 2 surface for  $j = 1, 2$ . If  $\partial X_j$  compresses in  $X_j$  for both  $j$ , then  $X_1$  and  $X_2$  are genus 2 handlebodies as  $M$  is hyperbolic. Since this possibility is excluded by our hypotheses,  $\partial X_j$  is incompressible in  $X_j$  for some  $j$ . Then it is essential in  $M$  but compresses in  $M(\beta)$ , so as in the previous paragraph,  $\beta$  is a singular slope for  $\partial X_j$ . Thus  $\Delta(\alpha, \beta) \leq 3$ . This completes the proof.  $\diamond$

Theorem 1.2 and Propositions 3.1 and 3.3 yield the following corollary.

**Corollary 3.4.** *Conjecture 1.1 holds as long as it holds when  $M(\alpha)$  is an irreducible, atoroidal, small Seifert manifold.*  $\diamond$

Here is a result from [BGZ2]. Recall from §6 of that paper that  $t_j^+$  is the number of *tight components* of  $\check{\Phi}_j^+$ .

A 3-manifold is *very small* if its fundamental group does not contain a non-abelian free group.

**Proposition 3.5.** *Suppose that  $F$  is a once-punctured essential genus 1 surface of boundary slope  $\beta$  in a hyperbolic knot manifold  $M$  which completes to an essential torus in  $M(\beta)$  but is not a fibre in  $M$ . If  $M(\alpha)$  is a small Seifert manifold, then*

$$\Delta(\alpha, \beta) \leq \begin{cases} 6 & \text{if } M(\alpha) \text{ is very small} \\ 8 & \text{otherwise} \end{cases}$$

Moreover if  $t_1^+ > 0$ , then

$$\Delta(\alpha, \beta) \leq \begin{cases} 3 & \text{if } M(\alpha) \text{ is very small} \\ 4 & \text{otherwise} \end{cases}$$

**Remark 3.6.** When  $t_1^+ = 0$ ,  $M(\beta)_{\hat{F}}$  is Seifert with base orbifold an annulus with one cone point [BGZ2, Lemma 7.9].

*Proof of Proposition 3.5.* The first inequality is the conclusion of [BGZ2, Proposition 13.2]. To deduce the second we use the notation and results of [BGZ2].

Suppose next that  $t_1^+ > 0$ . Since  $t_1^+$  is even and the number of boundary components  $F$  is bounded below by  $\frac{1}{2}t_1^+$ , we have  $t_1^+ = 2$ . Proposition 13.1 of [BGZ2] then shows that  $\Delta(\alpha, \beta) \leq 4$ . Suppose that  $M(\alpha)$  is very small. The first paragraph of the proof of [BGZ2, Proposition 13.1] shows that  $\Delta(\alpha, \beta) \leq 3$  if  $\bar{\Gamma}_S$  has a vertex of valency 3 or less while the second shows the same inequality holds if it doesn't. This completes the proposition's proof.  $\diamond$

#### 4. INVOLUTIONS ON SMALL SEIFERT MANIFOLDS

We collect several results about involutions on small Seifert manifolds in this section.

**Lemma 4.1.** *Let  $W$  be a small Seifert manifold and  $\tau$  an orientation-preserving involution on  $W$  with non-empty fixed point set. Then there is a  $\tau$ -invariant Seifert structure on  $W$  with base orbifold of the form  $S^2(a, b, c)$  where  $1 \leq a \leq b \leq c$ .*

*Proof.* If  $W$  is a lens space, the result follows from [HR]. Assume then that this isn't the case and fix a Seifert structure on  $W$  with base orbifold  $S^2(a, b, c)$  where  $a \leq b \leq c$ . The assumption that  $\pi_1(W)$  is not cyclic implies that  $a \geq 2$  and  $a, b, c$  are determined by  $W$ .

Let  $L \subset W/\tau$  be the branch set of  $\tau$ . The orbifold theorem implies that the orbifold  $W/\tau$  is geometric and since  $L$  is a link,  $W/\tau$  admits a Seifert structure with a 2-dimensional base orbifold [Du]. Thus  $W$  admits a  $\tau$ -invariant Seifert structure. We claim that we can assume this structure has base orbifold  $S^2(a, b, c)$ . If  $b \neq 2$ , all Seifert structures on  $W$  have this form, so assume  $a = b = 2 \leq c$ . If the base orbifold of the  $\tau$ -invariant structure is not  $S^2(a, b, c)$ , it must be  $P^2(d)$  for some integer  $d \geq 1$ . When  $d > 1$ , there is a unique singular fibre  $\phi$  in this structure, and it must be invariant under  $\tau$ . Then  $\tau$  leaves the exterior  $E$  of this fibre invariant, which is a twisted  $I$ -bundle over the Klein bottle. By assumption,  $\tau$  leaves the Seifert structure on  $E$  with base orbifold a Möbius band invariant. There is exactly one other Seifert structure on  $E$ , up to isotopy, and its base orbifold is  $D^2(2, 2)$ . Moreover, there is at least one such structure which is  $\tau|_E$ -invariant. This structure can be extended across a fibred neighbourhood of  $\phi$  in a  $\tau$ -invariant fashion yielding the desired  $\tau$ -invariant structure on  $W$ .

The argument is similar if  $d = 1$ , for  $\tau$  induces an involution of the base orbifold  $P^2$  of  $W$ , and since any self-map of  $P^2$  has a fixed point, there is a  $\tau$ -invariant fibre  $\phi$  in  $W$ . Now proceed as in the case  $d > 1$ .  $\diamond$

For our next three results we let  $W$  denote a small Seifert manifold and  $\tau$  an orientation-preserving involution on  $W$  with non-empty fixed point set such that the quotient  $W/\tau$  is a lens space  $L(\bar{p}, \bar{q}) \not\cong S^3$ . We use  $L_\tau$  to denote the branch set of  $\tau$  in  $L(\bar{p}, \bar{q})$ .

Fix a  $\tau$ -invariant Seifert structure on  $W$  with base orbifold of the form  $S^2(a, b, c)$  where  $1 \leq a \leq b \leq c$  (Lemma 4.1) and let  $\bar{\tau}$  be the involution of  $S^2(a, b, c)$  (possibly the identity) induced by  $\tau$ .

Since the  $\tau$ -invariant Seifert structure on  $W$  has an orientable base orbifold, its fibres can be coherently oriented.

Hodgson and Rubinstein have classified orientation-preserving involutions on lens spaces with non-empty fixed point sets. In particular, their work yields the following result.

**Lemma 4.2.** ([HR, §4.7]) *Suppose that  $W$  is the lens space  $L(p, q)$  and  $W/\tau = L(\bar{p}, \bar{q}) \not\cong S^3$ .*

- (1) *If  $p$  is odd, then  $L_\tau$  is connected and is either*
  - (a) *the core of a solid torus of a genus one Heegaard splitting of  $L(\bar{p}, \bar{q})$ ;*
  - (b) *the boundary of a Möbius band spine of a Heegaard solid torus of  $L(\bar{p}, \bar{q})$ ;*
- (2) *If  $p$  is even, then  $L_\tau$  has two components and is either*
  - (a) *the union of the cores of the two solid tori of a genus one Heegaard splitting of  $L(\bar{p}, \bar{q})$ ;*
  - (b) *the boundary of an annular spine of a Heegaard solid torus of  $L(\bar{p}, \bar{q})$ .  $\diamond$*

Next we suppose that  $W$  is not a lens space. In this case  $2 \leq a \leq b \leq c$ .

**Lemma 4.3.** *Suppose that  $W$  is not a lens space and that  $\tau$  preserves the orientations of the Seifert fibres of  $W$ . Then there is an induced Seifert structure on  $W/\tau$  such that  $L_\tau$  is a union of at most three Seifert fibres where at least one of the fibres is regular. Further,  $\bar{\tau}$  is either the identity or has two fixed points and*

- (1) *if  $\bar{\tau}$  is the identity then  $a = 2$ ,  $|L_\tau|$  is the number of cone points of  $S^2(a, b, c)$  of even order, and the components of  $L_\tau$  which are regular fibres correspond to the cone points of order 2.*
- (2) *if  $\bar{\tau}$  is not the identity then  $L_\tau$  has at most two components. Exactly one of its components is a regular fibre.*

*Proof.* The hypotheses imply that there is an induced Seifert structure on  $L(\bar{p}, \bar{q})$  whose fibres are the images of the fibres of  $W$ . Since  $W$  has three exceptional fibres,  $\bar{\tau}$  fixes precisely one or three cone points. In the latter case,  $\bar{\tau}$  is the identity.

Suppose first that  $\bar{\tau}$  is the identity on  $S^2(a, b, c)$ . Since  $\tau$  has a 1-dimensional fixed point set,  $\tau$  rotates the regular fibres of  $W$  by  $\pi$ . Its fixed point set is the union of the fibres of even multiplicity and therefore  $L_\tau$  is a union of Seifert fibres. The reader will verify that if a fibre of  $W$  has multiplicity  $k$ , then its image in  $L(\bar{p}, \bar{q})$  has multiplicity  $\bar{k} = \frac{k}{\gcd(k, 2)}$ . Hence as  $L(\bar{p}, \bar{q})$  has at most two exceptional fibres,  $a = 2$ .

Suppose next that  $\bar{\tau}$  fixes precisely one cone point of  $S^2(a, b, c)$ . In this case its fixed point set consists of this cone point and a regular point. Thus the fixed point set of  $\tau$  is contained in a union of two fibres, so  $L_\tau$  has at most two components. The reader will verify that each exceptional fibre of  $W$  is sent to an exceptional fibre of  $L(\bar{p}, \bar{q})$ , two of them to the same fibre. Thus the  $\tau$ -invariant regular fibre of  $W$  is sent to a regular fibre of  $L(\bar{p}, \bar{q})$ . It follows that this fibre lies in the fixed-point set of  $\tau$  and therefore  $L_\tau$  contains a regular fibre of  $L(\bar{p}, \bar{q})$ .  $\diamond$

**Lemma 4.4.** *Suppose that  $W$  is not a lens space and that  $\tau$  reverses the orientations of the Seifert fibres of  $W$ . If  $W/\tau = L(\bar{p}, \bar{q}) \not\cong S^3$ , then*

- (1)  $W$  has base orbifold  $S^2(\bar{p}, \bar{p}, m)$  where  $m \geq 2$  and the Seifert invariants of the exceptional fibres of order  $\bar{p}$  are the same. Hence if  $W$  is not a prism manifold,  $\bar{p} \neq 2$ .
- (2) There is an integer  $n$  coprime with  $m$  such that  $L_\tau$  is isotopic to the closure  $K(m/n)$  of an  $m/n$  rational tangle in a genus 1 Heegaard solid torus of  $W/\tau$  as depicted in Figure 1. In particular,

$$|L_\tau| = \begin{cases} 1 & \text{if } n \text{ is odd} \\ 2 & \text{if } n \text{ is even} \end{cases}$$

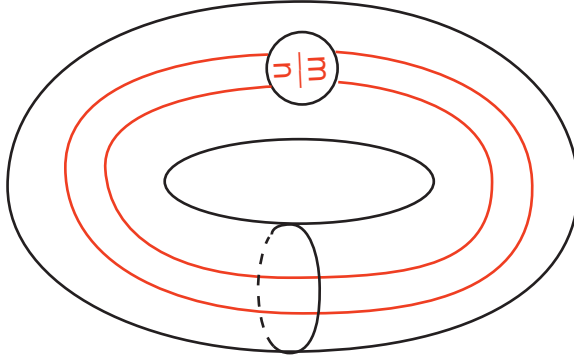

FIGURE 1.

*Proof.* The fixed point set of  $\bar{\tau}$  is non-empty so as it reverses orientation, it is reflection in an equator of  $S^2(a, b, c)$ . This equator cannot contain all three cone points as otherwise  $\tau$  would be the Montesinos involution on  $W$  and therefore  $L(\bar{p}, \bar{q})$  would be  $S^3$ . Thus it contains exactly one cone point and  $\bar{\tau}$  permutes the other two. It follows that up to relabeling,  $(a, b, c) = (r, r, m)$  for some integers  $r, m \geq 2$ . Further,  $S^2(r, r, m)/\bar{\tau} = D^2(r; m)$ , where  $D^2(r; m)$  is the 2-orbifold with underlying space a 2-disk and singular set consisting of a cone point of order  $r$ , a corner-reflector point  $x$  of order  $m$ , and a reflection line  $\partial D^2 \setminus \{x\}$ . Therefore  $L(\bar{p}, \bar{q}) = W/\tau \cong L(r, t)$  for some integer  $t$ . Thus  $r = \bar{p}$ , which proves part (1).

A Montesinos-type analysis of the quotient of the  $\tau$ -invariant solid torus given by the inverse image in  $W$  of a small annular neighbourhood of  $\text{Fix}(\bar{\tau})$  in  $S^2(\bar{p}, \bar{p}, m)$  shows that the branch set of this quotient is of the form described in part (2). It is well known that this branch set has one component if  $n$  is odd and two otherwise, so part (2) holds.  $\diamond$

## 5. BEGINNING OF THE PROOF OF THEOREM 1.3

**5.1. Assumptions.** We assume throughout the rest of the paper that  $M$  is a hyperbolic knot manifold containing an essential once-punctured torus  $F$  of boundary slope  $\beta$  which caps off to an essential torus in  $M(\beta)$  (cf. Corollary 3.2) and that  $M(\alpha)$  is an atoroidal, irreducible, small Seifert manifold (cf. Corollary 3.4). We assume as well that  $\Delta(\alpha, \beta) > 3$ , and (therefore)  $M_F$  is a genus 2 handlebody by Proposition 3.3.

We will show that under these assumptions,  $\Delta(\alpha, \beta) \leq 5$ ,  $F$  is not a fibre,  $\pi_1(M(\alpha))$  is finite non-cyclic, and

(a) if  $\Delta(\alpha, \beta) = 4$ ,  $(M; \alpha, \beta) \cong (Wh(\frac{-2n \pm 1}{n}); -4, 0)$  for some integer  $n$  with  $|n| > 1$  and  $M(\alpha)$  has base orbifold  $S^2(2, 2, |\mp 2n - 1|)$ ;

(b) if  $\Delta(\alpha, \beta) = 5$ , then  $(M; \alpha, \beta) \cong (Wh(-3/2); -5, 0)$  and  $M(\alpha)$  has base orbifold  $S^2(2, 3, 3)$ .

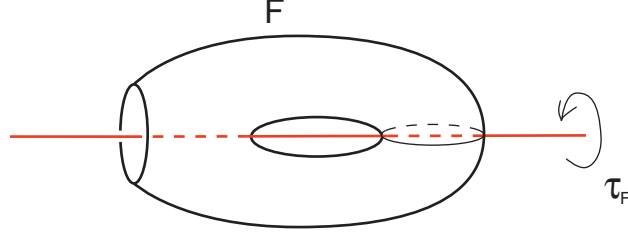

FIGURE 2.

**5.2. An involution on  $M$ .** There is an involution  $\tau_F$  on  $F$  with exactly three fixed points whose action on  $\partial F$  is rotation by  $\pi$ . See Figure 2. Thus  $F/\tau_F$  is the 2-orbifold  $D^2(2, 2, 2)$ . Let  $N \cong F \times I$  be a small neighbourhood of  $F$  in  $M$  and extend  $\tau_F$  to an involution  $\tau_N$  in the obvious way. Then  $\tau_N|_{F \times \partial I}$  extends to a hyperelliptic involution of  $\partial M_F$ . Since  $M_F$  is a genus 2 handlebody, the latter extends to an involution  $\tau_{M_F}$  of  $M_F$ . Piecing together  $\tau_N$  and  $\tau_{M_F}$  we obtain an orientation-preserving involution  $\tau : M \rightarrow M$  with non-empty 1-dimensional fixed point set  $\tilde{L} \subset \text{int}(M)$ . Further,  $V := M/\tau$  is a solid torus containing the branch set  $L$  of  $\tau$ . By construction, this is a hyperbolic link which intersects some meridional disk of  $V$  transversely and in three points. When  $F$  is a fibre in  $M$ ,  $L$  is braided in  $V$ .

Note that  $L$  cannot intersect any meridional disk in one point as  $M$  is  $\partial$ -irreducible.

The slopes on  $\partial M$  can be identified with  $\pm$ -classes of primitive elements of  $H_1(\partial M)$ . In particular we assume  $\alpha, \beta \in H_1(\partial M)$ . Let  $\mu$  be any dual slope to  $\beta$ . This means that  $1 = \Delta(\mu, \beta) = |\mu \cdot \beta|$ . Hence  $\{\mu, \beta\}$  form a basis for  $H_1(\partial M)$ . Write

$$(5.2.1) \quad \alpha = p\mu + q\beta$$

where  $p, q$  are coprime. After possibly changing the signs of  $\mu$  and  $\beta$  we may assume that

$$(5.2.2) \quad p = \Delta(\alpha, \beta)$$

Without loss of generality we may suppose that  $p \geq 1$ . The map  $M \rightarrow V$  is a double cover when restricted to  $\partial M$ . It sends  $\beta$  to a slope  $\bar{\beta}$ , a meridian of  $V$ , and sends  $\mu$  to  $\bar{\mu}$ , a longitude of  $V$ .

For each slope  $\gamma$  on  $\partial M$ ,  $\tau$  extends to an involution  $\tau_\gamma : M(\gamma) \rightarrow M(\gamma)$ . Moreover, if  $\tilde{U}_\gamma$  denotes the filling torus in  $M(\gamma)$  and  $\tilde{K}_\gamma$  its core, then

$$(5.2.3) \quad \text{Fix}(\tau_\gamma) = \begin{cases} \tilde{L} & \text{if } \Delta(\gamma, \beta) \text{ is odd} \\ \tilde{L} \cup \tilde{K}_\gamma & \text{if } \Delta(\gamma, \beta) \text{ is even} \end{cases}$$

It is clear that  $\tilde{U}_\gamma/\tau_\gamma$  is a solid torus  $U_\gamma$ . Denote its core  $\tilde{K}_\gamma/\tau_\gamma$  by  $K_\gamma$ . Thus  $M(\gamma)/\tau_\gamma = V \cup_{\tilde{\gamma}} U_\gamma$  is a lens space. Indeed, if  $\gamma = r\mu + s\beta$ , then under the double cover  $\partial M \rightarrow \partial V$  we have  $\gamma \mapsto r\bar{\mu} + 2s\bar{\beta}$ . Let  $\bar{\gamma} = \frac{1}{\gcd(2,r)}(r\bar{\mu} + 2s\bar{\beta})$  denote the associated slope and  $L_\gamma$  the branch set in  $M(\gamma)/\tau_\gamma$ . Then

$$(M(\gamma)/\tau_\gamma, L_\gamma) = (V(\bar{\gamma}), L_\gamma) \cong \begin{cases} (L(r, 2s), L) & \text{if } r \text{ is odd} \\ (L(\frac{r}{2}, s), L \cup K_\gamma) & \text{if } r \text{ is even} \end{cases}$$

We are interested in the case  $\gamma = \alpha$ . Set

$$(5.2.4) \quad \bar{p} = p/\gcd(p, 2) \quad \text{and} \quad \bar{q} = 2q/\gcd(p, 2)$$

so that  $\bar{\alpha} = \bar{p}\bar{\mu} + \bar{q}\bar{\beta}$  and

$$M(\alpha)/\tau_\alpha \cong L(\bar{p}, \bar{q})$$

From 5.2.3 we see that

$$(5.2.5) \quad |L_\alpha| = \begin{cases} |L| & \text{if } p \text{ is odd} \\ |L| + 1 & \text{if } p \text{ is even} \end{cases}$$

Fix a  $\tau_\alpha$ -invariant Seifert structure on  $M(\alpha)$  with base orbifold  $S^2(a, b, c)$  where  $1 \leq a \leq b \leq c$  (Lemma 4.1).

Let  $\bar{\tau}_\alpha$  be the involution of  $S^2(a, b, c)$  (possibly the identity) induced by  $\tau_\alpha$ .

**Lemma 5.1.** *Suppose that assumptions 5.1 hold. Suppose as well that  $M(\alpha)$  is not a lens space and that  $\tau_\alpha$  preserves the orientations of the Seifert fibres of  $M(\alpha)$ . Then there is a Seifert structure on  $L(\bar{p}, \bar{q})$  in which  $L_\alpha$  is a union of at most three fibres, at least one of which is regular. Further,  $L_\alpha = L$  so that  $p = \Delta(\alpha, \beta)$  is odd.*

*Proof.* Lemma 4.3 shows that  $L$  is a union of fibres in the induced Seifert structure on  $L(\bar{p}, \bar{q})$  and at least one of these fibres is regular. This implies that  $K_\alpha \not\subset L_\alpha$  as otherwise  $L = L_\alpha \setminus K_\alpha$  would not be a hyperbolic link in  $V$ . Thus  $L = L_\alpha$  so  $p$  is odd by 5.2.5.  $\diamond$

**Lemma 5.2.** *Suppose that assumptions 5.1 hold. Suppose as well that  $M(\alpha)$  is not a lens space and that  $\tau_\alpha$  reverses the orientations of the Seifert fibres of  $M(\alpha)$ . Then*

(1)  *$M(\alpha)$  has base orbifold  $S^2(\bar{p}, \bar{p}, m)$  where  $m \geq 2$  and the Seifert invariants of the exceptional fibres of order  $\bar{p}$  are the same. Hence if  $M(\alpha)$  is not a prism manifold,  $\Delta(\alpha, \beta) \neq 4$ .*

(2) *There is an integer  $n$  coprime with  $m$  such that  $L_\alpha$  is isotopic to the closure  $K(m/n)$  of an  $m/n$  rational tangle in a genus 1 Heegaard solid torus of  $M(\alpha)/\tau_\alpha$  as depicted in Figure 1. In particular,*

$$|L_\alpha| = \begin{cases} 1 & \text{if } n \text{ is odd} \\ 2 & \text{if } n \text{ is even} \end{cases}$$

(3)  *$|L| = 1$ ,  $m$  is odd, and  $n \equiv p \pmod{2}$ .*

*Proof.* Parts (1) and (2) follow from Lemma 4.4.

In order to prove part (3), suppose that  $|L| = 2$ . Then part (2) shows that  $L = L_\alpha$ . In particular,  $p$  is odd (5.2.5). Consideration of the form of  $L_\alpha$  (cf. Figure 1) shows that its two components are isotopic to one another. But since  $L$  is transverse to a meridian disk of  $V$  and intersects it in three points, the generator  $\gamma$  of  $H_1(V(\bar{\alpha})) \cong \mathbb{Z}/\bar{p}$  carried by the core of  $V$  satisfies  $\gamma = \pm 2\gamma$ . Hence  $\bar{p} = 3$ . But  $p$  is odd so  $\Delta(\alpha, \beta) = p = \bar{p} = 3$ , contrary to our hypotheses. Thus  $|L| = 1$ .

Next suppose that  $m$  is even. Then  $L_\alpha = K(m/n)$  is connected, so  $L = L_\alpha$  and  $p$  is odd, and  $L$  is homotopically trivial in  $L(\bar{p}, \bar{q})$ . But  $L$  intersects a meridian disk of the Heegaard torus  $V \subset L(\bar{p}, \bar{q})$  transversely and in three points, so the only way it can be null homotopic is for  $3 = \bar{p}$ . Since  $p$  is odd,  $p = 3$ , which contradicts our hypotheses. Thus  $m$  is odd.

By (2),  $|L_\alpha| \equiv n \pmod{2}$ . Since  $|L| = 1$  by (3), Identity 5.2.5 shows that  $|L_\alpha| \equiv p \pmod{2}$ .  $\diamond$

**5.3. Constraints on the branch set  $L$ .** Here we deduce strong constraints on the form of the branch set  $L$  in  $V$ .

**Lemma 5.3.** *Suppose that assumptions 5.1 hold and that  $\tau_\alpha$  reverses the orientation of the Seifert fibres of  $M(\alpha)$ . Let  $k \geq 1$  be an integer dividing  $\bar{p}$  and consider the  $k$ -fold cyclic cover  $S^2(\frac{\bar{p}}{k}, \frac{\bar{p}}{k}, m, m, \dots, m) \rightarrow S^2(\bar{p}, \bar{p}, m)$  obtained by the  $k$ -fold unwrapping of  $S^2(\bar{p}, \bar{p}, m)$  about the two cone points labeled  $\bar{p}$ . Let  $\widetilde{M(\alpha)}_k \rightarrow M(\alpha)$  be the associated  $k$ -fold cyclic cover where  $\widetilde{M(\alpha)}_k$  is Seifert with base orbifold  $S^2(\frac{\bar{p}}{k}, \frac{\bar{p}}{k}, m, m, \dots, m)$  and the inclusion of a regular fibre of  $M(\alpha)$  lifts to  $\widetilde{M(\alpha)}_k$ . Define  $\widetilde{M}_k \rightarrow M$  to be the cover obtained by restricting  $\widetilde{M(\alpha)}_k \rightarrow M(\alpha)$  to  $M$ . Then*

- (1)  $\partial\widetilde{M}_k$  is connected and  $F$  lifts to  $\widetilde{M}_k$ . In particular,  $\beta$  lifts to a slope  $\tilde{\beta}$  on  $\partial\widetilde{M}_k$ .
- (2)  $\alpha$  lifts to a slope  $\tilde{\alpha}$  on  $\partial\widetilde{M}_k$  such that  $\widetilde{M(\alpha)}_k = \widetilde{M}_k(\tilde{\alpha})$ . Further,  $\Delta(\tilde{\alpha}, \tilde{\beta}) = \frac{p}{k}$ .
- (3)  $\tilde{\alpha}$  is the singular slope of a closed essential surface in  $\widetilde{M}_k$  if  $S^2(\frac{\bar{p}}{k}, \frac{\bar{p}}{k}, m, m, \dots, m)$  is hyperbolic with at least four cone points. If this is the case,  $p/k \leq 3$ .

*Proof.* The cover  $S^2(\frac{\bar{p}}{k}, \frac{\bar{p}}{k}, m, m, \dots, m) \rightarrow S^2(\bar{p}, \bar{p}, m)$  is determined by the homomorphism  $\varphi : H_1(S^2(\bar{p}, \bar{p}, m)) = \langle x, y : \bar{p}x = \bar{p}y = m(x+y) = 0 \rangle \rightarrow \mathbb{Z}/k$  where  $\varphi(x) \equiv -\varphi(y) \equiv 1 \pmod{k}$ .

First note that the homomorphism  $H_1(M(\alpha)) \rightarrow H_1(V(\bar{\alpha})) \cong \mathbb{Z}/\bar{p}$  kills any class carried by a regular Seifert fibre of  $M(\alpha)$  (i.e. there are regular fibres with image an interval). Thus it factors through a homomorphism  $\psi : H_1(S^2(\bar{p}, \bar{p}, m)) \rightarrow H_1(V(\bar{\alpha}))$ . Since  $\tau_\alpha$  preserves the fibre of multiplicity  $m$  in  $M(\alpha)$ , but reverses its orientation,  $(\bar{\tau}_\alpha)_*(x+y) = -(x+y)$ . Thus  $2(x+y)$  is sent to zero in  $H_1(V(\bar{\alpha}))$  while  $x$  is sent to a generator. Since  $m$  is odd and  $m(x+y) = 0$ ,  $x+y \mapsto 0 \in H_1(V(\bar{\alpha}))$ . It follows that  $\varphi$  factors as  $H_1(S^2(\bar{p}, \bar{p}, m)) \xrightarrow{\psi} H_1(V(\bar{\alpha})) \xrightarrow{\cong} \mathbb{Z}/\bar{p} \rightarrow \mathbb{Z}/k$ . Since  $H_1(F)$  lies in the kernel of  $H_1(M) \rightarrow H_1(V)$  while  $\mu$  is sent to a generator of  $H_1(V)$ , we conclude that  $\partial\widetilde{M}_k$  is connected and  $F$  lifts to  $\widetilde{M}_k$ . This proves (1).

For (2), note that by construction, there is a basis  $\{\tilde{\mu}, \tilde{\beta}\}$  of  $H_1(\partial\widetilde{M}_k)$  where  $\tilde{\mu}$  is sent to  $k\mu$  and  $\tilde{\beta}$  is sent to  $\beta$  in  $H_1(\partial M)$ . Then  $\alpha = p\mu + q\beta$  lifts to  $(\frac{p}{k})\tilde{\mu} + q\tilde{\beta}$ . Clearly  $\Delta(\tilde{\alpha}, \tilde{\beta}) = \frac{p}{k}$ .

Part (3) is a consequence of [BGZ1, Theorems 1.5 and 1.7].  $\diamond$

**Lemma 5.4.** *Suppose that assumptions 5.1 hold. Then  $M$  is not a once-punctured torus bundle. In particular, Theorem 1.3 holds when  $F$  is a fibre.*

**Proof.** We assume that  $M$  is a once-punctured torus bundle in order to obtain a contradiction.

There is a 3-braid  $\sigma$  whose closure in  $V$  is  $L$ . Altering  $\sigma$  by conjugation in  $B_3 = \langle \sigma_1, \sigma_2 : \sigma_1\sigma_2\sigma_1 = \sigma_2\sigma_1\sigma_2 \rangle$  leaves its closure invariant. (Here  $\sigma_1, \sigma_2$  are the standard generators of  $B_3$ .) There is an isomorphism  $B_3 \cong \langle a, b : a^3 = b^2 \rangle$  where  $a = \sigma_1\sigma_2$  and  $b = \sigma_1\sigma_2\sigma_1$ . The center of  $B_3$  is generated by  $a^3$  with  $B_3/\langle a^3 \rangle \cong \mathbb{Z}/2 * \mathbb{Z}/3$ . We will use  $\bar{\sigma}$  to denote the image of a braid  $\sigma$  in  $B_3/\langle a^3 \rangle$ . Thus  $\bar{a}$  has order 3 and  $\bar{b}$  has order 2. In particular,

$$\begin{aligned}\bar{\sigma}_1 &= \bar{a}^{-1}\bar{b} \\ \bar{\sigma}_2 &= \bar{b}\bar{a}^2\end{aligned}$$

The inverse image  $\widehat{L}$  of  $L \subset V \subset L(\bar{p}, \bar{q})$  under the universal cover  $S^3 \rightarrow L(\bar{p}, \bar{q})$  is the closure of the braid  $\sigma^{\bar{p}}a^{-3\bar{q}}$ .

**Claim 5.5.**  *$\widehat{L}$  is not the trivial knot.*

*Proof of Claim 5.5.* If  $\widehat{L}$  is trivial then  $\sigma^{\bar{p}}a^{-3\bar{q}}$  is conjugate to  $\sigma_1\sigma_2, \sigma_1^{-1}\sigma_2^{-1}$ , or  $\sigma_1\sigma_2^{-1}$  ([BiMe, Classification Theorem, page 27]). The first two cases can be ruled out since they would imply that the exterior of  $\widehat{L}$  in the inverse image of  $V$  in  $S^3$  is not hyperbolic. On the other hand, in the third case we have  $\bar{\sigma}^{\bar{p}} = \bar{\sigma}_1\bar{\sigma}_2^{-1} = \bar{a}^2\bar{b}\bar{a}\bar{b} \in B_3/\langle a^3 \rangle \cong \mathbb{Z}/2 * \mathbb{Z}/3$ . But this is impossible since  $\bar{a}^2\bar{b}\bar{a}\bar{b}$  is not a proper power.  $\diamond$

**Claim 5.6.**  *$\tau_\alpha$  preserves the orientation of the Seifert fibres of  $M(\alpha)$ . In particular,  $\widehat{L}$  is a union of fibres in some Seifert structure on  $S^3$  and  $p$  is odd.*

*Proof of Claim 5.6.* Suppose otherwise and consider the  $\bar{p}$ -fold cyclic cover  $\widetilde{M}_{\bar{p}} \rightarrow M$  constructed in Lemma 5.3. The base orbifold  $S^2(m, m, \dots, m)$  of  $\widetilde{M}(\alpha)$  has  $\bar{p}$  cone points, each of order  $m \geq 3$  by Lemma 5.2(3). If  $\bar{p} \geq 4$ , Lemma 5.3 (3) implies that  $\widetilde{M}_{\bar{p}}$  contains a closed essential surface, contrary to [CJR] or [FH]. Hence  $\bar{p}$  is 2 or 3 and therefore as  $p > 3$ ,  $p$  is 4 or 6. Identity 5.2.5 then combines with parts (2) and (3) of Lemma 5.2 to show that  $|L_\alpha| = 2$  and  $m$  is odd. It follows that each component of  $L_\alpha$  is isotopic to the core of a genus one Heegaard solid torus in  $L(\bar{p}, \bar{q})$  (cf. Figure 1). In particular this is true of  $L = L_\alpha \setminus K_\alpha$ . It follows that  $\widehat{L}$  is a trivial knot, contrary to the conclusion of Claim 5.5. Thus  $\tau_\alpha$  preserves the orientation of the Seifert fibres of  $M(\alpha)$ . The remaining conclusions are a consequence of Lemma 5.1.  $\diamond$

Claim 5.6 implies that  $\bar{p} = p$  and  $\bar{q} = 2q$ .

Since  $L$  is a hyperbolic link in  $V$ ,  $\widehat{L}$  is a hyperbolic link in the inverse image of  $V$  in  $S^3$ . Thus the Schreier normal form for  $\sigma^p a^{-6q}$  is generic (cf. [FKP, Theorem 5.2]). On the other hand,



by Claim 5.6,  $\widehat{L}$  is not a hyperbolic link in  $S^3$  so [FKP, Theorem 5.5] implies that  $\sigma^p a^{-6q}$  is conjugate in  $B_3$  to a braid of the form  $\sigma_1^c \sigma_2^d$  where  $c, d \in \mathbb{Z} \setminus \{0\}$ . We must have  $\min\{|c|, |d|\} = 1$  as otherwise  $\widehat{L}$  would be a connected sum of non-trivial torus links, contrary to the conclusion of Claim 5.6. Thus  $\sigma^p a^{-6q}$  is conjugate to  $\sigma_1^c \sigma_2^\epsilon$  for some  $\epsilon \in \{\pm 1\}$  and non-zero  $c$ . The following claim completes the proof of Lemma 5.4.

**Claim 5.7.** *If  $p > 3$ ,  $\sigma^p a^{-6q}$  is not conjugate to  $\sigma_1^c \sigma_2^\epsilon$  for any  $\epsilon \in \{\pm 1\}$ .*

*Proof of Claim 5.7.* Suppose that  $\sigma^p a^{-6q}$  is conjugate to  $\sigma_1^c \sigma_2^\epsilon$  for some  $\epsilon \in \{\pm 1\}$ . Projecting into  $B_3/\langle a^3 \rangle$  shows that  $\bar{\sigma}_1^c \bar{\sigma}_2^\epsilon$  is a  $p^{\text{th}}$ -power in that group. The latter condition is invariant under conjugation and taking inverse, so without loss of generality we can suppose that  $\epsilon = 1$ . Now

$$\bar{\sigma}_1^c \bar{\sigma}_2 = (\bar{a}^{-1} \bar{b})^c (\bar{b} \bar{a}^{-1}) = \begin{cases} (\bar{b} \bar{a})^{|\bar{c}|} (\bar{b} \bar{a}^{-1}) & \text{if } c \leq 0 \\ \bar{a} & \text{if } c = 1 \\ \bar{a}^{-1} \bar{b} \bar{a} & \text{if } c = 2 \\ (\bar{a}^{-1} \bar{b}) \bar{a}^{-1} (\bar{a}^{-1} \bar{b})^{-1} & \text{if } c = 3 \\ (\bar{a}^{-1} \bar{b} \bar{a}) (\bar{a} \bar{b}) (\bar{a}^{-1} \bar{b})^{c-4} (\bar{a}^{-1} \bar{b} \bar{a})^{-1} & \text{if } c > 3 \end{cases}$$

Consideration of the normal form for elements of  $\mathbb{Z}/2 * \mathbb{Z}/3$  shows that the only values of  $c$  which give proper powers in  $B_3/\langle a^3 \rangle$  are  $c = 1, 2$ , or  $3$ .

Say  $c = 1$  or  $3$ . Then up to conjugation,  $\bar{\sigma}^p = \bar{a}^{\pm 1}$  and therefore  $\bar{\sigma} = \bar{a}^{\pm 1}$ . Hence  $\sigma = a^{3k \pm 1}$  for some integer  $k$ . But then it is easy to see that  $L$  is boundary-parallel in  $V$ , contrary to the fact that  $V \setminus L$  is hyperbolic.

Next suppose that  $c = 2$ . Then  $\bar{\sigma}^p = \bar{b}$  up to conjugation and therefore the same is true of  $\bar{\sigma}$ . As  $a^3 = b^2$ ,  $\sigma = b^{2n+1}$  for some integer  $n$ . Then  $L \subset \text{int}(V)$  has two components. One is a core curve  $K_0$  of  $V$  while the other is isotopic in  $V \setminus K_0$  into  $\partial V$ . It follows that there is an essential annulus properly embedded in the exterior of  $L$  in  $\text{int}(V)$ . But this contradicts the fact that  $L$  is a hyperbolic link in  $V$ .  $\diamond$

$\diamond$ (of Lemma 5.4)

Recall that  $t_1^+$  is the number of tight components of  $\check{\Phi}_1^+$  (cf. [BGZ2, §6]).

**Lemma 5.8.** *Suppose that assumptions 5.1 hold. Then  $t_1^+ = 0$ . In particular,  $M(\beta)_{\widehat{F}}$  is Seifert with base orbifold of the form  $A(a)$  where  $A$  is an annulus and  $a \geq 2$ .*

*Proof.* Lemma 5.4 implies that  $F$  is not a fibre and so Proposition 3.5 and Remark 3.6 show that the lemma holds as long as either  $M(\alpha)$  is very small or  $\Delta(\alpha, \beta) > 4$ . Assume then that  $M(\alpha)$  is not very small and that  $\Delta(\alpha, \beta) = 4$ . The latter equality combines with Lemma 5.1 to show that  $\tau_\alpha$  reverses the orientations of the fibres of  $M(\alpha)$ . But then Lemma 5.2(1) implies that  $M(\alpha)$  is a prism manifold, contradicting our assumption that  $M(\alpha)$  is not very small. Thus the lemma holds.  $\diamond$

**Lemma 5.9.** *Suppose that assumptions 5.1 hold. Then there are coprime integers  $a \geq 2$  and  $b$  as well as a 3-braid  $\sigma$  such that  $L$  is isotopic to the link depicted in Figure 3.*

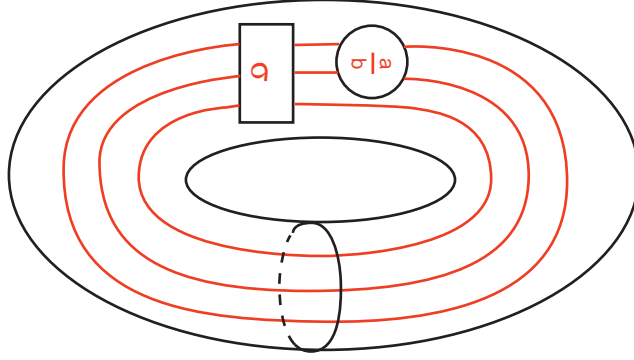

FIGURE 3.

*Proof.* By Lemma 5.8,  $M(\beta)_{\widehat{F}}$  is Seifert with base orbifold of the form  $A(a)$  where  $A$  is an annulus and  $a \geq 2$ . Consider the involution  $\widehat{\tau} : M(\beta)_{\widehat{F}} \rightarrow M(\beta)_{\widehat{F}}$  induced by  $\tau_\beta$ . Note that  $M(\beta)_{\widehat{F}}/\widehat{\tau} = V(\overline{\beta})_{\widehat{F}/\widehat{\tau}} \cong (S^2 \times S^1)_{S^2 \times \{x\}} \cong S^2 \times I$ . Now  $M(\beta)_{\widehat{F}}$  has a unique Seifert structure which we can suppose is  $\widehat{\tau}$ -invariant. Let  $\overline{\tau}$  be the induced involution on  $A(a)$ . Note  $\overline{\tau}$  cannot preserve orientation as otherwise  $M(\beta)_{\widehat{F}}/\widehat{\tau} \cong S^2 \times I$  would admit a Seifert structure. Thus it reverses orientation and since it fixes the cone point and leaves each boundary component invariant, it must be reflection along a pair of disjoint properly embedded arcs, each of which runs from one boundary component to the other. The quotient  $A(a)/\overline{\tau}$  is a disk whose boundary contains two disjoint, compact arcs, each a reflector arc, one of which contains the  $\mathbb{Z}/a$  cone point. It follows that the branch set in  $M(\beta)_{\widehat{F}}/\widehat{\tau} \cong S^2 \times I$  consists of a 2-braid and an  $\frac{a}{b}$ -rational tangle running from one end to the other which are separated by a properly embedded vertical annulus. See Figure 4.

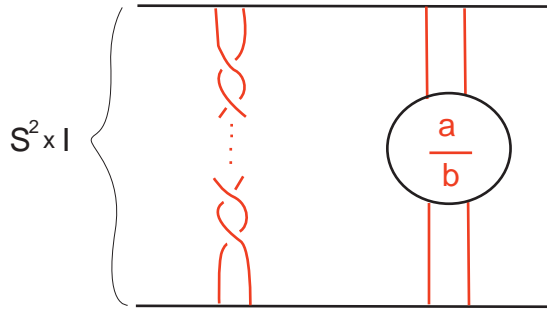

FIGURE 4.

We claim that  $K_\beta \cap M(\beta)_{\widehat{F}}$  is a component of the 2-braid. To see this, first note that by Lemma 5.8,  $\check{\Phi}_1^+$  has no tight components. Next we refer the reader to the final paragraph of the proof of [BGZ2, Lemma 7.9]. It is shown there that  $M_F = X^+$  is obtained by attaching a solid torus  $V$  to the product of an interval  $I$  and a once-punctured annulus  $A_*$  where  $V \cap (A_* \times I)$  is a pair of annuli which have winding number  $a$  in  $V$  and components of  $\partial A_* \times I$  in  $A_* \times I$ . This decomposition is invariant under the restriction of  $\widehat{\tau}$  to  $M_F$  and it is easy to see that the quotient of  $V$  contains the  $\frac{a}{b}$ -rational tangle. Since  $(\partial M)_{\partial F} \subset A_* \times I$  is disjoint from  $V$ , it follows that  $K_\beta \cap M(\beta)_{\widehat{F}}$  is a component of the 2-braid. Thus  $L \cap M_F/\tau$  is as depicted in Figure

5, where  $\delta$  is a 3-braid. It follows that there is a 3-braid  $\sigma$  such that  $L$  is as depicted in Figure 3.  $\diamond$

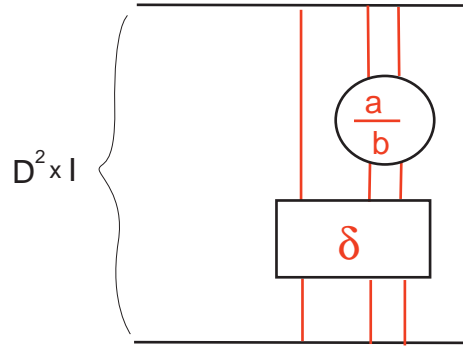

FIGURE 5.

**5.4. The lens space case.** The methods of this paper can be used to give a new proof of Ken Baker's theorem: *if  $M$  contains a once-punctured essential genus 1 surface of boundary slope  $\beta$  and  $M(\alpha)$  is a lens space, then  $\Delta(\alpha, \beta) \leq 3$*  [Ba]. We begin the proof here and complete it in §8.

**Lemma 5.10.** *Suppose that assumptions 5.1 hold. If  $\pi_1(M(\alpha))$  is cyclic, then  $p = 5$ ,  $F$  is not a fibre, and  $L_\alpha$  is either the core of a solid torus of a genus one Heegaard splitting of  $L(5, 2q)$  or the boundary of a Möbius band spine of a Heegaard solid torus of  $L(5, 2q)$ .*

*Proof.* We know that  $F$  is not a fibre (Lemma 5.4), so  $p = \Delta(\alpha, \beta) \leq 6$  by Proposition 3.5. As  $\Delta(\alpha, \beta) = p \geq 4$ ,  $M(\alpha)/\tau_\alpha \cong L(\bar{p}, \bar{q})$  is not  $S^3$ . Hence by Lemma 4.2,  $L_\alpha$  is a union of Seifert fibres of some Seifert fibring of  $L(\bar{p}, \bar{q})$ . Since  $L$  is hyperbolic in  $V$ ,  $K_\alpha$  cannot be contained in  $L_\alpha$ . Thus  $p$  is odd by 5.2.3, so  $p = \bar{p} = 5$ ,  $\bar{q} = 2q$ , and  $L = L_\alpha$ . Lemma 4.2(1) then shows that  $L_\alpha$  is either the core of a solid torus of a genus one Heegaard splitting of  $L(5, 2q)$  or the boundary of a Möbius band spine of a Heegaard solid torus of  $L(5, 2q)$ .  $\diamond$

**Remark 5.11.** We can complete the proof of Baker's result mentioned above at this point by invoking a theorem of Sangyop Lee [L3] which states that the distance between a toroidal filling slope and a lens space filling slope is at most 4. Nevertheless, we give an independent proof that  $\Delta(\alpha, \beta) \neq 5$  (and so  $\Delta(\alpha, \beta) \leq 3$ ) in §8 below.

**5.5. Reduction of the proof of Theorem 1.3.** In this section we reduce the proof of Theorem 1.3 to several problems concerning links. These will be solved in the subsequent sections of the paper. We begin with a slight sharpening of our upper bound for  $\Delta(\alpha, \beta)$ .

**Lemma 5.12.** *If assumptions 5.1 hold, then  $\Delta(\alpha, \beta) < 8$ .*

*Proof.* By Lemma 5.4,  $F$  is not a fibre in  $M$ . Hence  $\Delta(\alpha, \beta) \leq 8$  by Proposition 3.5 (or [LM]). Suppose that  $\Delta(\alpha, \beta) = 8$ . Then  $M(\alpha)$  is not very small by Proposition 3.5. Further, Proposition 3.3 implies that  $M_F$  is a genus two handlebody, so we can construct an involution

$\tau$  as above. Then Lemma 5.1 implies that  $\tau_\alpha$  reverses the orientations of the Seifert fibres of  $M(\alpha)$ . Parts (1) and (3) of Lemma 5.2 imply that  $M(\alpha)$  has a Seifert structure with base orbifold  $S^2(4, 4, m)$  where  $m \geq 3$  is odd. Let  $\widetilde{M}_2 \rightarrow M$  be the 2-fold cover constructed in Lemma 5.3. By part (2) of that lemma,  $\widetilde{M}_2(\widetilde{\alpha})$  is Seifert with base orbifold  $S^2(4, 4, m, m)$ . But then Lemma 5.3 (3) implies  $4 = \frac{8}{2} \leq 3$ , which is false. Thus  $\Delta(\alpha, \beta) \neq 8$ .  $\diamond$

**Lemma 5.13.** *Suppose that assumptions 5.1 hold and that  $\Delta(\alpha, \beta) = 4$ . Then  $M(\alpha)$  is a prism manifold.*

*Proof.* Since  $\Delta(\alpha, \beta)$  is even,  $M(\alpha)$  is not a lens space (Lemma 5.10) and so Lemma 5.1 implies that  $\tau_\alpha$  reverses the orientations of the fibres of  $M(\alpha)$ . Lemma 5.2(1) now implies that  $M(\alpha)$  is a prism manifold.  $\diamond$

Given the last two lemmas, to complete the proof of Theorem 1.3 under assumptions 5.1, we must consider the possibility that  $\Delta(\alpha, \beta) \in \{5, 6, 7\}$  besides the case when  $\Delta(\alpha, \beta) = 4$  and  $M(\alpha)$  is a prism manifold. We do this by comparing the constraints obtained above on the branch sets  $L$  and  $L_\alpha$ :

- $L$  lies in  $V$  as depicted in Figure 3 (Lemma 5.9);
- when  $M(\alpha)$  is not a lens space and  $\tau_\alpha$  preserves the orientation of the Seifert fibres of  $M(\alpha)$ , then  $\Delta(\alpha, \beta)$  is odd and  $L_\alpha$  is the union of at most three fibres of some Seifert structure on  $L(\bar{p}, \bar{q})$  (Lemma 5.1);
- when  $M(\alpha)$  is not a lens space and  $\tau_\alpha$  reverses the orientation of the Seifert fibres of  $M(\alpha)$ , then  $L_\alpha$  lies in some Heegaard solid torus of  $L(\bar{p}, \bar{q})$  as depicted in Figure 1 (Lemma 4.4);
- when  $M(\alpha)$  is a lens space, then  $\Delta(\alpha, \beta) = 5$  and  $L_\alpha$  is either the core of a Heegaard solid torus of  $L(5, 2q)$  or the boundary of a Möbius band spine of a Heegaard solid torus of  $L(5, 2q)$  (Lemma 5.10).

The proof of Theorem 1.3 therefore reduces to proving the following claims.

- (1) If  $\tau_\alpha$  preserves the orientation of the Seifert fibres and  $M(\alpha)$  is not a lens space, then  $\Delta(\alpha, \beta) = 5$  and  $(M; \alpha, \beta)$  is homeomorphic to  $(Wh(-3/2); -5, 0)$ .
- (2) The links contained in the universal cover  $S^3$  of  $L(7, \bar{q})$  which are depicted in Figure 17 and Figure 18 are not equivalent when  $\Delta(\alpha, \beta) = 7$ ,  $|L| = 1$ ,  $m$  is odd, and  $n \equiv 1 \pmod{2}$ .
- (3) the link depicted in Figure 3 considered as lying in a Heegaard solid torus in  $L(5, 2q)$  is not isotopic to either the core of a Heegaard solid torus or the boundary of a Möbius band spine of a Heegaard solid torus.
- (4) The links contained in a Heegaard solid torus in  $L(3, \bar{q})$  depicted in Figure 1 and Figure 3 are not equivalent.

- (5) The links contained in the universal cover  $S^3$  of  $L(5, \bar{q})$  which are depicted in Figure 26 and Figure 27 are not equivalent in the universal cover  $S^3$  of  $L(5, \bar{q})$  when  $\Delta(\alpha, \beta) = 5$ ,  $|L| = 1$ ,  $m$  is odd, and  $n \equiv 1 \pmod{2}$ .
- (6)  $\Delta(\alpha, \beta) = 4$  and  $M(\alpha)$  is a prism manifold if and only if  $(M; \alpha, \beta) \cong (Wh(\frac{-2n \pm 1}{n}); -4, 0)$  for some integer  $n$  with  $|n| > 1$ .

These will be proved in §6, §7, §8, §9, §10 and §12 respectively.

## 6. THE CASE THAT $\tau_\alpha$ PRESERVES THE ORIENTATION OF THE SEIFERT FIBRES, $M(\alpha)$ IS NOT A LENS SPACE, AND $\Delta(\alpha, \beta) \in \{5, 7\}$ .

In this section we suppose that assumptions 5.1 hold and show that if  $\tau_\alpha$  preserves the orientation of the Seifert fibres,  $M(\alpha)$  is not a lens space, and  $\Delta(\alpha, \beta) \in \{5, 7\}$ , then  $\Delta(\alpha, \beta) = 5$  and  $(M; \alpha, \beta)$  is homeomorphic to  $(Wh(-3/2); -5, 0)$ .

By hypothesis,  $M(\alpha)$  is small Seifert with exactly three singular fibres. It is not a prism manifold by [L2] and so has a unique Seifert structure. Recall that  $M(\alpha)/\tau_\alpha = V(\bar{\alpha})$  is the lens space  $L(\bar{p}, \bar{q}) = L(p, 2q)$  and the branch set of  $\tau_\alpha$  in  $L(p, 2q)$  is a link denoted by  $L_\alpha$ . As  $p$  is odd,  $L_\alpha = L$  (cf. 5.2.5).

Suppose that  $L_\alpha$  is a Seifert link with respect to the induced Seifert fibration on  $L(p, 2q) = M(\alpha)/\tau_\alpha$ . We need to show that  $p = 5$  and  $(M; \alpha, \beta)$  is homeomorphic to  $(Wh(-3/2); -5, 0)$ .

By Lemma 5.1, at least one component of  $L$  is a regular fibre of  $L(p, 2q)$ . Let  $K$  be such a component and denote by  $X$  the exterior of  $L$  in  $L(p, 2q)$ . Then  $X$  has the induced Seifert fibration with  $|\partial X| = |L|$  boundary components, each a torus. Let  $T_K$  be the component of  $\partial X$  corresponding to the knot  $K$ .

**Lemma 6.1.** *There is an essential separating vertical annulus  $(A, \partial A) \subset (X, T_K)$  which cuts  $X$  into two components  $X_1$  and  $X_2$  such that each  $X_i$  is either a torus cross interval or a fibred solid torus whose core is a singular fibre of  $X$  of order larger than 2.*

*Proof.* The lemma follows from Lemma 4.3 and its proof. Let  $\bar{\tau}_\alpha$  be the induced map on the orbifold  $S^2(a, b, c)$  of  $M(\alpha)$  where each of  $a, b, c$  is  $\geq 2$ . Then  $\bar{\tau}_\alpha$  is either the identity or an involution with two fixed points. Let  $\sigma_1, \sigma_2, \sigma_3$  denote the singular fibres of  $M(\alpha)$  and let their orders be  $a, b, c$  respectively.

First assume that  $\bar{\tau}_\alpha$  is the identity map. Then Lemma 4.3(a) implies that at least one of  $a, b, c$ , say  $a$ , is 2 and the fixed point set of  $\tau_\alpha$  in  $M(\alpha)$  is the union of those  $\sigma_i$  with even orders. In particular  $\sigma_1$  belongs to the fixed point set of  $\tau_\alpha$  and its image in  $L(p, 2q)$  is a regular fibre. Note that if  $\sigma_2$ , respectively  $\sigma_3$ , does not belong to the fixed point set of  $\tau_\alpha$ , then  $b$ , respectively  $c$ , is odd, and the image of  $\sigma_2$ , respectively  $\sigma_3$ , in  $L(p, 2q)$  is a fibre of  $L(p, 2q)$  of order  $b$ , respectively  $c$ . Hence the sum of  $|\partial X| = |L|$  and the number of the singular fibres of  $X$  equals 3. Since the surface underlying the base orbifold of  $X$  is planar, the lemma follows in this case.

Next assume that  $\bar{\tau}_\alpha$  is an involution. Then two of the singular fibres of  $M(\alpha)$ , say  $\sigma_1$  and  $\sigma_2$ , have the same order  $a = b$ . Both are mapped to a common singular fibre in  $L(p, 2q)$  of order  $a$ . Since  $M(\alpha)$  is not a prism manifold,  $a = b > 2$ .

By Lemma 4.3(b), the fixed point set of  $\tau_\alpha$  in  $M(\alpha)$  consists of a regular fibre and possibly the remaining singular fibre  $\sigma_3$ . If  $\sigma_3$  does not belong to  $\text{Fix}(\tau_\alpha)$ , then its image in  $L(p, 2q)$  is a singular fibre of order  $2c \geq 4$  and therefore the sum  $|\partial X| = |L|$  and the number of the singular fibres of  $X$  again equals 3. As in the previous case, the lemma follows from this.  $\diamond$

Recall that  $K_\alpha$  is the core circle of the filling solid torus in  $V(\bar{\alpha}) = L(p, 2q)$ . The exterior  $Y$  of  $K_\alpha$  in  $X$  is also the exterior of  $L$  in  $V$  and so is hyperbolic. Let  $T_V = \partial V \subset \partial Y$ .

The solid torus  $V$  has a meridian disk  $D$  which intersects  $L$  in three points such that  $P = D \cap Y$  is an essential thrice-punctured disk in  $Y$ . Let  $d_V = \partial P \cap T_V$  and let  $c_1, c_2, c_3$  be the three components of  $\partial P$  contained in  $\partial Y \setminus T_V$ . Note  $d_V$  has the slope  $\bar{\beta}$  in  $T_V$ , and each  $c_i$  is a meridian curve of some component of  $L$ .

Among all annuli satisfying the conditions of Lemma 6.1, we choose one, denoted  $A$ , which intersects  $T_V$  in the minimal number of components. Since  $Y$  is hyperbolic,  $A \cap T_V$  is non-empty. The surface  $Q = A \cap Y$  is essential in  $Y$ . Since  $A$  is separating in  $X$ ,  $\partial Q \cap T_V$  consists of an even number, say  $n$ , of simple essential loops in  $T_V$  of slope  $\bar{\alpha}$ . Let  $a_1, a_2$  be the two components of  $\partial Q$  in  $T_K$ , and let  $b_1, \dots, b_n$  be the components of  $\partial Q$  in  $T_V$  numbered so that they occur successively around  $d_V$ . Each  $a_i$  is a Seifert fibre of  $X$ , and each  $b_j$  has slope  $\bar{\alpha}$  on  $T_V$ . If  $c_j$  is a meridian curve of  $K$ , then the distance between  $c_j$  and  $a_i$  is 1 since  $K$  is a regular fibre of  $L(p, 2q)$ .

Now define the labeled intersection graphs  $\Gamma_P$  and  $\Gamma_Q$  as usual. We may consider  $d_V, c_1, c_2, c_3, a_1, a_2, b_1, \dots, b_n$  as the boundaries of the fat vertices of these graphs. Each  $b_i, i = 1, \dots, n$ , has valency  $p = \Delta(\bar{\alpha}, \bar{\beta}) = \Delta(\alpha, \beta)$ , and the valency of  $d_V$  is  $np$ . Note that the valency of  $a_1$  is equal to the valency of  $a_2$  and is equal to the number of  $c_i$ 's which are meridians of  $K$ . Further, the valency of  $c_i$  is either 2 or 0 depending on whether  $c_i$  is a meridian curve of  $K$  or not.

We call the edges in  $\Gamma_Q$  connecting some  $b_i$  to some  $b_j$  *B-edges*, and call the edges in  $\Gamma_P$  connecting  $d_V$  to itself *D-edges*. Similarly we define *A-edges*, *C-edges*, *AB-edges*, and *CD-edges*. Note that an arc in  $P \cap Q$  is a *B-edge* in  $\Gamma_Q$  if and only if it is a *D-edge* in  $\Gamma_P$ , is an *A-edge* in  $\Gamma_Q$  if and only if it is an *C-edge* in  $\Gamma_P$ , and is an *AB-edge* in  $\Gamma_Q$  if and only if it is a *CD-edge* in  $\Gamma_P$ .

Every *D-edge* is positive, so by the parity rule, every *B-edge* is negative. By construction, no *D-edge* in  $\Gamma_P$  is boundary parallel in  $P$ . Thus there are at most three different *D-edges* in the reduced graph  $\bar{\Gamma}_P$  (cf. Figure 6).

**Lemma 6.2.** *There can be no S-cycle in  $\Gamma_P$  consisting of D-edges.*

*Proof.* Suppose otherwise that  $\{e_1, e_2\}$  is an *S-cycle* in  $\Gamma_P$  consisting of *D-edges* with label pair  $\{j, j+1\}$ . We may assume that the bigon face  $E$  between  $e_1$  and  $e_2$  lies on the  $X_1$ -side of  $A$ .

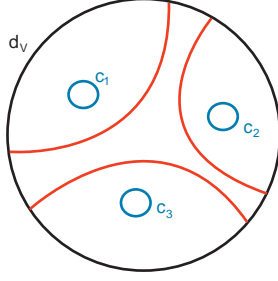
 FIGURE 6. The maximal possible  $D$ -edges in  $\overline{\Gamma}_P$ 

Let  $H$  be the portion of the filling solid torus of  $L(p, 2q)$  lying in  $X_1$  which contains  $\hat{b}_j$  and  $\hat{b}_{j+1}$ . In  $\Gamma_Q$ ,  $e_1 \cup b_j \cup e_2 \cup b_{j+1}$  cannot be contained in a disk region  $D_*$  of  $A$  as otherwise a regular neighborhood of  $D_* \cup E \cup H$  in  $X_1$  would be a punctured projective space. Thus  $e_1 \cup b_j \cup e_2 \cup b_{j+1}$  contains a core circle of  $A$  (cf. Figure 7).

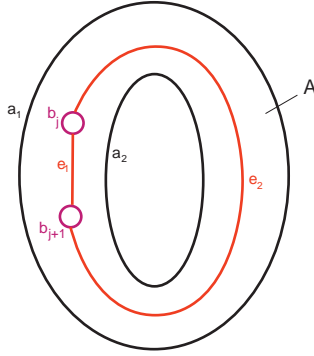
 FIGURE 7. The corresponding cycle  $\{e_1, e_2\}$  in  $\Gamma_Q$ 

Let  $U$  be a regular neighborhood of  $E \cup H \cup A$  in  $X_1$ . Then  $U$  is a solid torus and the frontier of  $U$  in  $X_1$  is an annulus  $(A', \partial A') \subset (X, T_K)$  for which  $\partial A'$  is parallel to  $\partial A$  in  $T_K$  and which intersects  $T_V$  in  $n - 2$  components. By construction,  $A'$  is inessential in  $X_1$  and therefore  $X_1$  cannot be a torus cross interval. It follows that  $X_1$  is a fibred solid torus of  $X$ . Since  $A'$  has winding number 2 in the solid torus  $U$ , the singular fibre of  $X_1$  has order 2, contrary to Lemma 6.1. Thus the lemma holds.  $\diamond$

Note that  $\Gamma_P$  has at most six  $CD$ -edges and thus  $\Gamma_P$  has at least  $(np - 6)/2$   $D$ -edges, so there is a family of at least  $(np - 6)/6$  mutually parallel  $D$ -edges. By Lemma 6.2 we have  $(np - 6)/6 \leq n/2$ . Hence  $n \leq 6/(p - 3)$  and therefore  $p = 5$  and  $n = 2$ . If  $\Gamma_P$  has a  $C$ -edge, it would have only one family of parallel  $D$ -edges, and this family would have at least three edges, contrary to the fact that no two  $D$ -edges can be parallel in  $\Gamma_P$  by Lemma 6.2. Also,  $\Gamma_P$  has at least four  $CD$ -edges as otherwise there would be four  $D$ -edges two of which would form an  $S$ -cycle. Thus  $\Gamma_P$  has either six or four  $CD$ -edges.

We first consider the case when there are exactly four  $CD$ -edges. In this case we have three  $D$ -edges in  $\Gamma_P$ , no two of which can be parallel. Hence  $\Gamma_P$  may be assumed to be as illustrated

in Figure 8, i.e.  $c_1$  and  $c_2$  are contained in  $T_K$  and  $c_3$  is contained  $\partial X \setminus T_K$ . Thus  $|L| = |\partial X| = 2$  and we may assume that  $X_1$  is a solid torus and  $X_2$  is a torus cross interval. In particular  $c_3$  is contained in  $X_2$ .

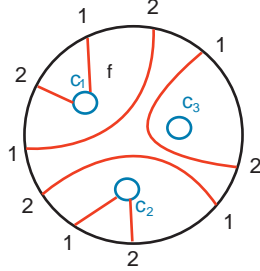

FIGURE 8.  $\Gamma_P$  when  $\Delta(\alpha, \beta) = 5$ ,  $n = 2$  and 4  $CD$ -edges.

Consider the face  $f$  given in Figure 8. From the figure we see that  $f$  and  $c_3$  are on the same side of  $A$  (since  $A$  is separating in  $X$ ) and thus  $f$  is contained in  $X_2$ . Let  $T_*$  be the component of  $\partial X_2$  containing  $A$  and  $H$  that part of filling solid torus of  $L(p, 2q)$  contained in  $X_2$ . We use  $\partial_0 H$  to denote  $\partial H \cap T_V$ . It is evident that the boundary  $\partial f$  of  $f$  is contained in  $T_* \cup \partial_0 H$ . Also note that  $\partial f \cap T_*$  cannot be contained in a disk in  $T_*$  as otherwise  $X_2$  would contain a projective space as a summand. Thus  $\partial f \cap T_*$  is contained in an annulus  $A_*$  of  $T_*$ . A regular neighborhood  $W$  of  $H \cup f \cup T_*$  in  $X_2$  is a Seifert fibred space whose base orbifold is an annulus with a cone point of order 2. Since  $X_2$  is a torus cross interval, the frontier of  $W$  in  $X_2$  is an incompressible torus in  $X_2$ . But this torus cannot be parallel to  $T_*$  in  $X_2$ , contradicting the fact that  $X_2$  is a torus cross interval. Thus the case when there are exactly four  $CD$ -edges does not arise.

We now know that  $\Gamma_P$  must have six  $CD$ -edges. Hence there are exactly two  $D$ -edges in  $\Gamma_P$  and they are not parallel. It follows that  $\Gamma_P$  is as illustrated in Figure 9 (1) or (2). (Without loss of generality, we may assume that the labels around  $d_V$  are as shown in these figures and that the vertices  $c_1$ ,  $c_2$  and  $c_3$  are numbered as given there.) Therefore  $L = K$  and both  $X_1$  and  $X_2$  are solid tori.

We are going to show that part (1) of Figure 9 cannot arise and that in case of part (2) of Figure 9 the dual graph  $\Gamma_Q$  may be assumed to be as shown in part (6) of Figure 10.

**Lemma 6.3.** *The graph  $\Gamma_P$  cannot be as shown in part (1) of Figure 9.*

*Proof.* Suppose otherwise that  $\Gamma_P$  is given by part (1) of Figure 9. Since  $A$  is a separating annulus, the faces  $f_1, f_2$  of  $\Gamma_P$  lie on the same side of  $A$ , say in  $X_1$ , and the faces  $g_1, g_2$  lie in  $X_2$ .

Let  $H$  be the part of the filling solid torus of  $L(p, 2q)$  contained in  $X_1$  and set  $\partial_0 H = \partial H \cap T_V$ . The boundary edges of  $f_1$  consist of two  $CD$ -edges  $e_1, e_2$  and one  $D$ -edge  $e_3$ . Without loss of generality, we may assume that the label of the edge  $e_1$  at the vertex  $c_1$  is 2. In  $\Gamma_Q$ , the boundary edges of  $f_1$  may be assumed to be as illustrated in part (1) of Figure 10. Note that the boundary  $\partial f_1$  of  $f_1$ , including the corners, lies in  $\partial X_1 \cup \partial_0 H$ . Further,  $\partial f_1 \cap \partial X_1$  is

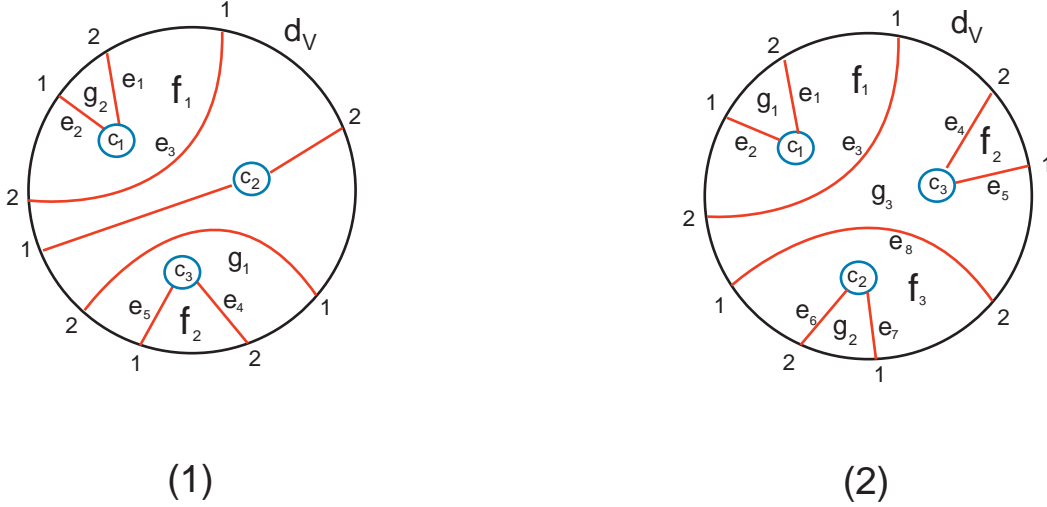

 FIGURE 9.  $\Gamma_P$  when  $p = 5$ ,  $n = 2$  with 6  $CD$ -edges

contained in an annulus  $A_*$  of  $\partial X_1$  whose slope has distance 1 from that of  $\partial A$ . Note as well that  $\partial f_1 \cap (\partial X_1 \setminus A)$  is an essential arc in the annulus  $(\partial X_1 \setminus A)$ . A regular neighborhood  $U$  of  $H \cup f_1 \cup A_*$  in  $X_1$  is a solid torus whose frontier in  $X_1$  is an annulus  $A_\#$  of winding number 2 in  $U$ . Thus  $A_\#$  must be parallel to  $\partial X_1 \setminus A_*$  through  $X_1 \setminus U$ . It follows that the fundamental group of  $X_1$  is carried by  $U$  and thus has presentation

$$\langle x, t; x^2 t = 1 \rangle$$

where we take a fat base point in  $A$  containing  $b_1 \cup b_2 \cup (\partial f_1 \cap A) \cup (\text{all } AB\text{-edges})$ ,  $x$  is a based loop formed by a cocore arc of  $\partial_0 H$ , and  $t$  is a based loop formed by a cocore arc of  $\partial X_1 \setminus A$ .

Now consider the face  $f_2$ . We claim that the label of the edge  $e_4$  at the vertex  $c_3$  cannot be 2. Otherwise in  $\Gamma_Q$ , the boundary edges of  $f_2$ ,  $e_4$  and  $e_5$  would be as depicted in part (2) or part (3) of Figure 10. In either case, the face  $f_2$  would add the relation  $xts = 1$  to the presentation for  $\pi_1(X_1)$  above, where  $s$  is the element represented by a core circle of the annulus  $A$ . Thus the fundamental group of the solid torus  $X_1$  would be generated by  $s = x$ . But  $s$  can be considered as a regular fibre of  $X$ . So the singular fiber of  $X_1$  would have order one, which contradicts Lemma 6.1.

Thus the label of  $e_4$  at  $c_3$  is 1. It follows that in  $\Gamma_Q$ , the edges  $e_4$  and  $e_5$  are as shown in part (4) of Figure 10, and the face  $f_2$  adds the relation  $xt^{-1}s = 1$  to the presentation for  $\pi_1(X_1)$ , where  $s$  is the element represented by a core circle of the annulus  $A$ . Therefore  $s = x^{-3}$ . Since  $s$  can be considered as a regular fibre of  $X$  and  $x$  can be considered as a core circle of the solid torus  $X_1$ , the singular fiber in  $X_1$  has order 3.

With the same argument, we see that the existence of the faces  $g_1$  and  $g_2$  in part (1) of Figure 9 implies that the singular fiber in  $X_2$  has order 3. Hence the two singular fibers of  $X$  both have order 3 which implies that the order of the lens space  $L(p, 2q)$  is divisible by 3. But the lens space has order  $p = \Delta(\alpha, \beta) = 5$ , yielding a contradiction. So part (1) of Figure 9 cannot arise.  $\diamond$

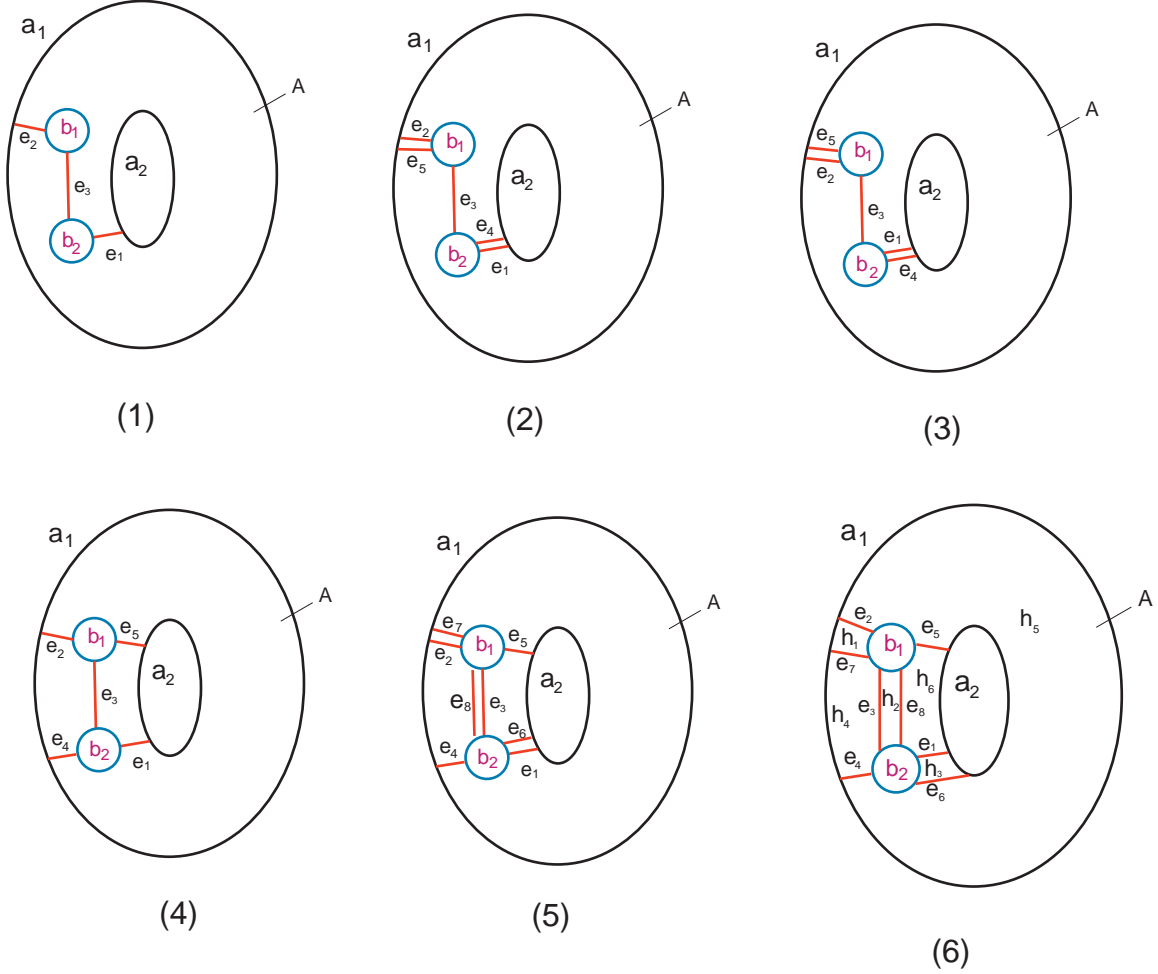
 FIGURE 10. About the graph  $\Gamma_Q$ 

So  $\Gamma_P$  must be as shown in part (2) of Figure 9. Note that the faces  $f_1, f_2, f_3$  lie on the same side of  $A$ , say  $X_1$ , and the faces  $g_1, g_2, g_3$  in  $X_2$ . Arguing similarly as the proof of Lemma 6.3, we see that in the dual graph  $\Gamma_Q$  the edges  $e_1, e_2, e_3, e_4$  and  $e_5$  may be assumed to be as shown in part (4) of Figure 10.

We now consider the face  $g_3$ . Note that  $\partial g_3$  must be contained in an annulus  $A'$  of  $\partial X_2$  whose slope has distance 1 from that of  $\partial A$  and that  $\partial g_3 \cap (\partial X_2 \setminus A)$  is an essential arc in the annulus  $(\partial X_2 \setminus A)$ . Thus  $e_8$  is parallel to  $e_3$  in  $\Gamma_Q$ . By combining this with the argument given in Lemma 6.3 we see that the graph  $\Gamma_Q$  must be as depicted in part (5) or part (6) of Figure 10.

**Lemma 6.4.** *Figure 10(5) is impossible.*

*Proof.* In Figure 9(2), let  $p_0, p_1, p_2, p_3, p_4$  be the points labeled 1 on  $d_V$ , in cyclic order around  $d_V$ . These are points of intersection of  $b_1$  with  $d_V$  on the torus  $T_V$ . It follows that the corresponding points appear around  $b_1$  in the order  $p_0, p_d, p_{2d}, p_{3d}, p_{4d}$ , for some  $d$  coprime to  $\Delta = \Delta(\alpha, \beta) = 5$ . The point  $p_i$  is the endpoint of an edge  $e_{j(i)}$ . Then, denoting  $p_i$  by the label  $j(i)$  of the corresponding edge, the cyclic order of the  $p_i$ 's around  $d_V$  in Figure 9(2) is 28753.

In the graph  $\Gamma_Q$  in Figure 10(5), the order of the corresponding points is 82753. Since these cyclic orderings are not related in the manner described above,  $\Gamma_Q$  cannot be as illustrated in Figure 10(5).  $\diamond$

**Remark 6.5.** In Figure 10(6) the order is 27385, which is of the required form, with  $d = 2$ .

So far we have shown that  $p = \Delta(\alpha, \beta) = 5$  and the graphs  $\Gamma_P$  and  $\Gamma_Q$  must be as shown in part (2) of Figure 9 and part (6) of Figure 10 respectively. In the rest of this section we are going to show that these conditions determine the triple  $(M, \alpha, \beta)$  uniquely up to homomorphism, and thus it must be the triple  $(Wh(-3/2); -5, 0)$ .

The surface  $Q$  separates  $Y$  into  $Y_1$  and  $Y_2$ , say, where  $Y_i \subset X_i$ ,  $i = 1, 2$ . Let  $N$  be a regular neighbourhood of  $T_V \cup T_K \cup P \cup Q$  in  $Y$ , and let  $\partial_0 N = \partial N \setminus (T_V \cup T_K)$ . Then  $\partial_0 N = \partial_1 N \cup \partial_2 N$  where  $\partial_i N \subset Y_i$ ,  $i = 1, 2$ .

**Lemma 6.6.** *For  $i = 1$  and  $2$ ,  $\partial_i N$  has two components, each a 2-sphere.*

*Proof.* By Remark 6.5, the curves  $d_V, b_1, b_2$  on the torus  $T_V$  are as shown in Figure 11. They decompose  $T_V$  into rectangles  $R_1, \dots, R_5, S_1, \dots, S_5$ , where the  $R_i$ 's lie in  $Y_1$  and the  $S_i$ 's in  $Y_2$ . In Figure 11 a point of intersection of  $b_1 \cup b_2$  with  $d_V$  is labeled with the edge of which it is an endpoint. Similarly, the curves  $a_1, a_2, c_1, c_2, c_3$  decompose the torus  $T_K$  into rectangles  $T_1, T_2, T_3, U_1, U_2, U_3$ , where the  $T_j$ 's lie in  $Y_1$  and the  $U_j$ 's in  $Y_2$ . See Figure 12.

The faces of the graph  $\Gamma_P$  are  $f_1, f_2, f_3, g_1, g_2, g_3$ , where the  $f_i$ 's lie in  $Y_1$  and the  $g_i$ 's lie in  $Y_2$ ; see Figure 9 (2). Let the faces of  $\Gamma_Q$  be  $h_1, \dots, h_6$ , as shown in Figure 10(6).

The regular neighbourhood  $N$  is the union of product neighbourhoods  $T_V \times [0, 1], T_K \times [0, 1], P \times [-1, 1]$  and  $Q \times [-1, 1]$ , in the obvious way, where  $T_V = T_V \times \{0\}, T_K = T_K \times \{0\}, P = P \times \{0\}$ , and  $Q = Q \times \{0\}$ . Corresponding to  $R_i$  is a 2-cell contained in  $(T_V \times \{1\}) \cap \partial_0 N$ , which we continue to denote by  $R_i$ ; similarly for  $S_i, T_j$  and  $U_j$ . A face  $f_i$  of  $\Gamma_P$  gives rise to two 2-cells  $f_i^+ \subset (P \times \{1\}) \cap \partial_0 N$  and  $f_i^- \subset (P \times \{-1\}) \cap \partial_0 N$ , and similarly for the  $g_i$ 's and the faces  $h_k$  of  $\Gamma_Q$ . Since  $h_k^+ \subset \partial_1 N$  and  $h_k^- \subset \partial_2 N$ , there will be no confusion in denoting  $h_k^\pm$  by  $h_k$ .

By carefully examining the identifications between these various 2-cells one sees that  $\partial_1 N$  has two components  $\Sigma_1$  and  $\Sigma'_1$ , and  $\partial_2 N$  has two components  $\Sigma_2$  and  $\Sigma'_2$ , composed of the following 2-cells:

$$\begin{aligned} \Sigma_1: & f_1^+, f_3^-, h_1, h_2, h_3, R_2, R_5, T_1 \\ \Sigma'_1: & f_1^-, f_2^+, f_2^-, f_3^+, h_4, h_5, h_6, R_1, R_3, R_4, T_2, T_3 \\ \Sigma_2: & g_1^+, g_2^-, h_1, h_3, S_1, U_1 \\ \Sigma'_2: & g_1^-, g_2^+, g_3^+, g_3^-, h_2, h_4, h_5, h_6, S_5, S_2, S_3, S_4, U_2, U_3 \end{aligned}$$

The precise patterns of identification are shown in Figures 13, 14, 15 and 16, respectively. In particular,  $\Sigma_1, \Sigma'_1, \Sigma_2, \Sigma'_2$  are 2-spheres.  $\diamond$

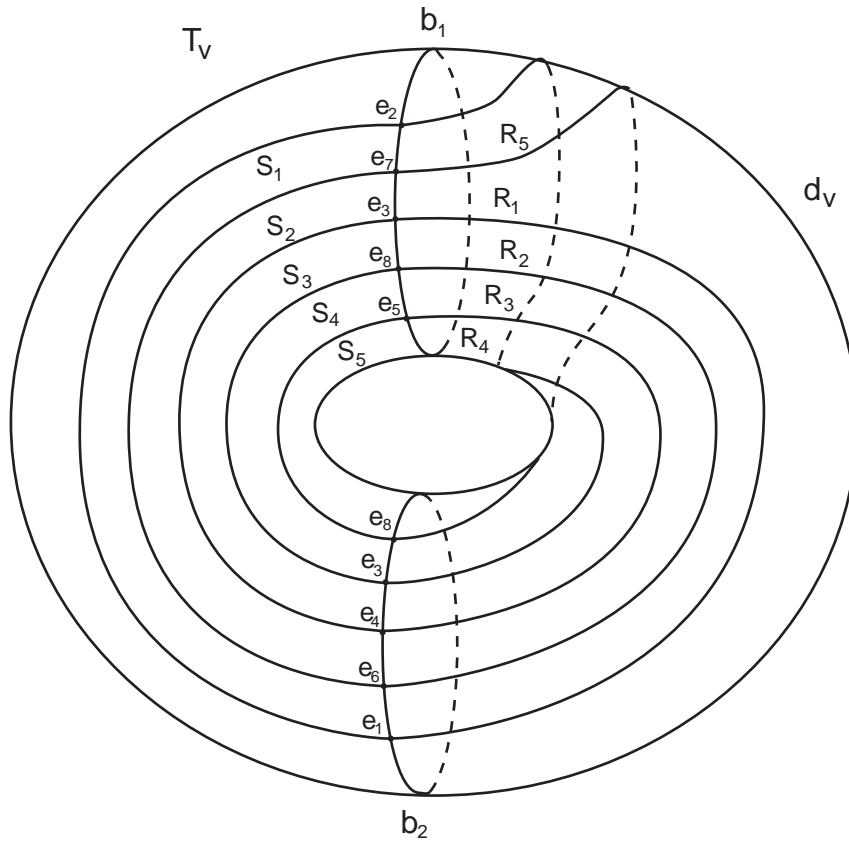

FIGURE 11.

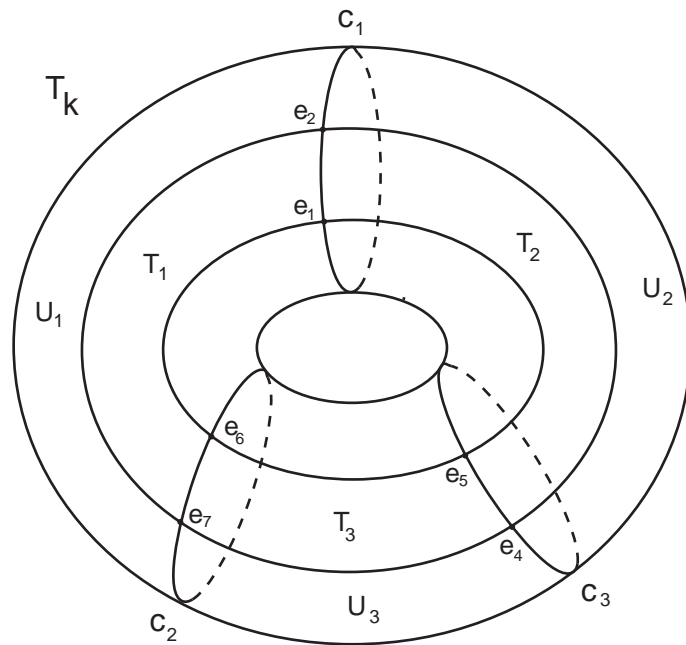

FIGURE 12.

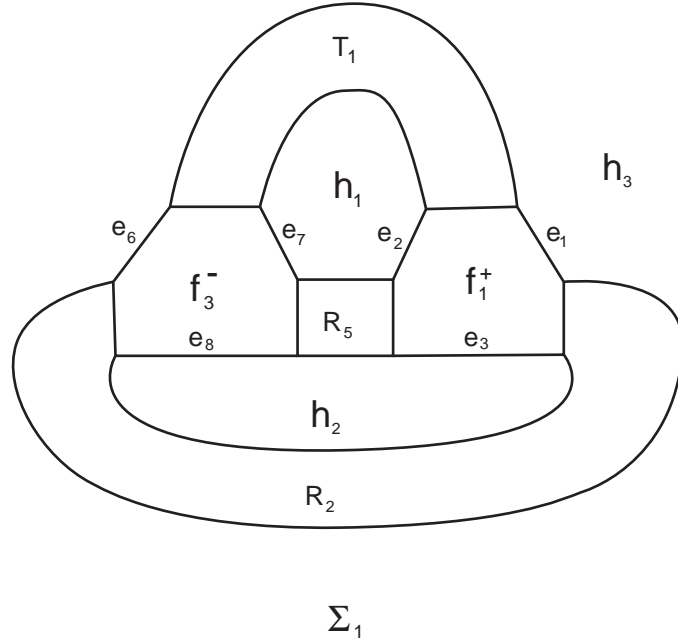

FIGURE 13.

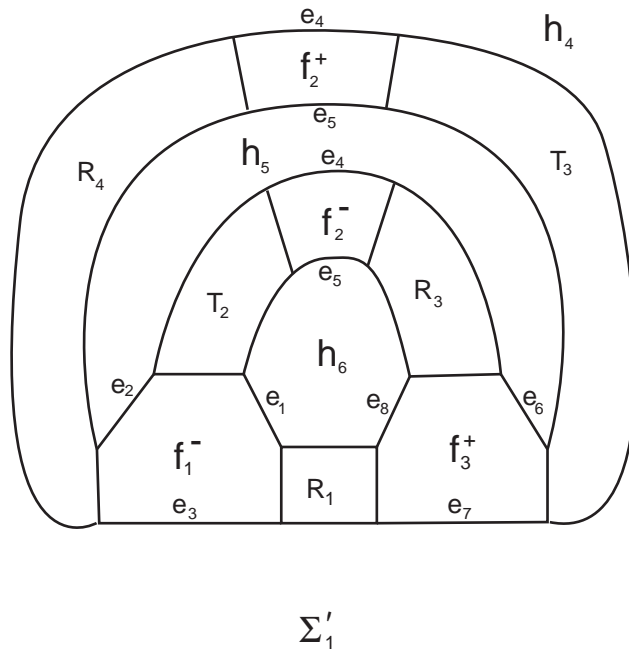

FIGURE 14.

**Remark 6.7.** One can see that  $\Sigma_1, \Sigma'_1, \Sigma_2, \Sigma'_2$  are 2-spheres without completely determining the identification patterns of their constituent 2-cells, by means of the following Euler characteristic computation.



Also,  $(P \cup Q) \cap T_V$  consists of three circles, meeting in a total number of 10 points. So  $\chi((P \cup Q) \cap T_V) = -10$ . Similarly  $\chi((P \cup Q) \cap T_K) = -6$ . Therefore

$$\chi(N) = \chi((P \cup Q) \cup (T_V \cup T_K)) = (-12) + 0 - ((-10) + (-6)) = 4$$

Hence  $\chi(\partial N) = 8$ .

Now one can easily check that each of  $\partial_1 N$  and  $\partial_2 N$  has at most two components. Hence each must have exactly two components, both 2-spheres.

*Proof that  $(M; \alpha, \beta)$  is homeomorphic to  $(Wh(-3/2); -5, 0)$ .* Since  $Y$  is irreducible the components of  $\partial_0 N$  bound 3-balls in  $Y$ . Hence the triple  $(Y; P, Q)$  is uniquely determined up to homeomorphism, by Figures 9 (2) and 10(6). Since the curves  $c_j$  are meridians of  $L$ , the pair  $(V, L)$ , together with the slopes  $\bar{\alpha}, \bar{\beta}$ , is uniquely determined. Passing to the double branched cover, we have that  $(M; \alpha, \beta)$  is uniquely determined.

In [MP, Table A3] it is shown that  $-5$ -filling on the hyperbolic manifold  $Wh(-3/2)$  is Seifert fibred with base orbifold  $S^2(2, 3, 3)$ , while  $0$ -filling gives a manifold containing a non-separating torus. In fact, it is easy to see that  $Wh(-3/2)$  contains an essential once-punctured torus with boundary slope  $0$ . Hence  $(M; \alpha, \beta) \cong (Wh(-3/2); -5, 0)$ .  $\diamond$

#### 7. THE CASE $\Delta(\alpha, \beta) = 7$ AND THE INVOLUTION $\tau_\alpha$ REVERSES THE ORIENTATIONS OF THE SEIFERT FIBRES OF $M(\alpha)$

In this section we suppose that assumptions 5.1 hold and show that it is impossible for  $\Delta(\alpha, \beta)$  to be 7 and for  $\tau_\alpha$  to reverse the orientations of the Seifert fibres of  $M(\alpha)$ . We assume otherwise in order to obtain a contradiction.

A *tangle* will be a pair  $\mathcal{T} = (R, t)$ , where  $R$  is  $S^3$  minus the interiors of a disjoint union of 3-balls, and  $t$  is a properly embedded 1-manifold. Let  $\tilde{\mathcal{T}} = (X, \tilde{t})$  be the double branched cover of  $\mathcal{T}$ . In our examples each boundary component  $S$  of  $R$  will meet  $t$  in either 4 or 6 points, and hence the corresponding boundary component  $\tilde{S}$  of  $X$  is either a torus or a surface of genus 2, respectively.

An *essential disk* in  $\mathcal{T}$  is a properly embedded disk  $D$  in  $R$  such that either

- (i)  $D \cap t = \emptyset$  and  $\partial D$  does not bound a disk in  $\partial R \setminus t$ ; or
- (ii)  $D$  meets  $t$  transversely in a single point and  $\partial D$  does not bound a disk in  $\partial R$  containing a single point of  $t$ .

It follows from the  $\mathbb{Z}/2$ -equivariant Disk Theorem ([GLi], [KT], [YM]) that  $X$  contains an essential disk  $\tilde{D}$ , i.e., a properly embedded disk such that  $\partial \tilde{D}$  is essential in  $\partial X$ , if and only if  $\mathcal{T}$  contains an essential disk  $D$ .

If  $S$  is a boundary component of  $R$  such that  $|S \cap t| = 4$ , a *marking* of  $S$  is a specific identification of  $(S, S \cap t)$  with  $(S^2, \{NE, NW, SW, SE\})$ . We can then attach a rational tangle  $\mathcal{R}(\gamma)$  to  $\mathcal{T}$  along  $S$  with respect to this marking, where  $\gamma \in \mathbb{Q} \cup \{1/0\}$ .

By Lemma 4.4 (1),  $M(\alpha) = M(7/q)$  has base orbifold  $S^2(7, 7, m)$  for some odd integer  $m \geq 3$ . As in Lemma 5.3, let  $\widetilde{M}_7$  be the 7-fold cyclic cover of  $M$ ; then  $\partial\widetilde{M}_7$  is a single torus, and both  $\alpha$  and  $\beta$  lift to slopes  $\tilde{\alpha}$  and  $\tilde{\beta}$  in  $\partial\widetilde{M}_7$ , i.e.  $\widetilde{M}_7(\tilde{\alpha})$  is a 7-fold cyclic cover of  $M(\alpha)$  and  $\widetilde{M}_7(\tilde{\beta})$  is a 7-fold cyclic cover of  $M(\beta)$ . Furthermore the involution  $\tau$  on  $M$  lifts to an involution  $\tilde{\tau}$  on  $\widetilde{M}_7$  and  $\tilde{V} = \widetilde{M}_7/\tilde{\tau}$  is a 7-fold cyclic cover of  $M/\tau = V$ . So  $\tilde{V}$  is a solid torus. The involution  $\tilde{\tau}$  extends to an involution  $\tilde{\tau}_{\tilde{\alpha}}$  on  $\widetilde{M}_7(\tilde{\alpha})$  such that  $\widetilde{M}_7(\tilde{\alpha})/\tilde{\tau}_{\tilde{\alpha}} = S^3$  is the 7-fold cyclic cover of the lens space  $M(\alpha)/\tau_{\alpha} = L(7, 2q)$ . Let  $L_7$  be the inverse image of  $L$  in  $S^3$ . Then by Lemma 5.9,  $L_7$  is as shown in Figure 17 where the box with an integer  $r$  in it stands for  $r$  full horizontal twists, and by Lemma 4.4 (2),  $L_7$  is also as shown in Figure 18, where the box with an integer  $r'$  in it stands for  $r'$  full horizontal twists. Since  $p = 7$ ,  $n$  is odd by Lemma 5.2(3). Hence from Figure 18 we see that  $L_7$  is a single knot. So to get a contradiction, we just need to show that the two knots  $K$  and  $K'$  shown in Figures 17 and 18 respectively are inequivalent.

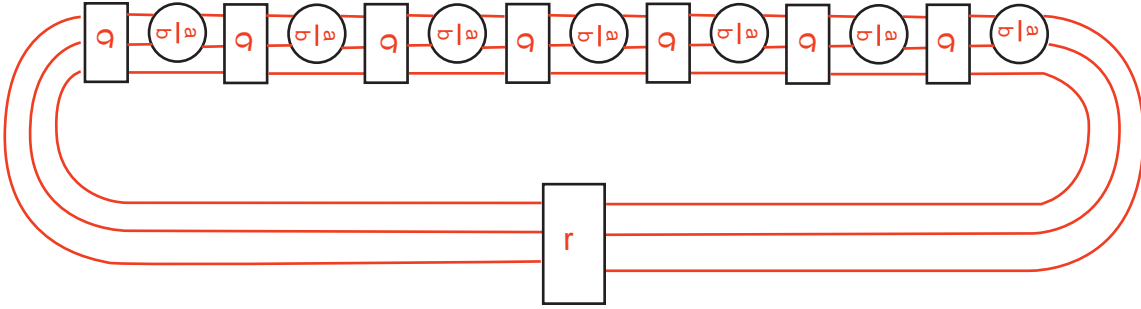

FIGURE 17.

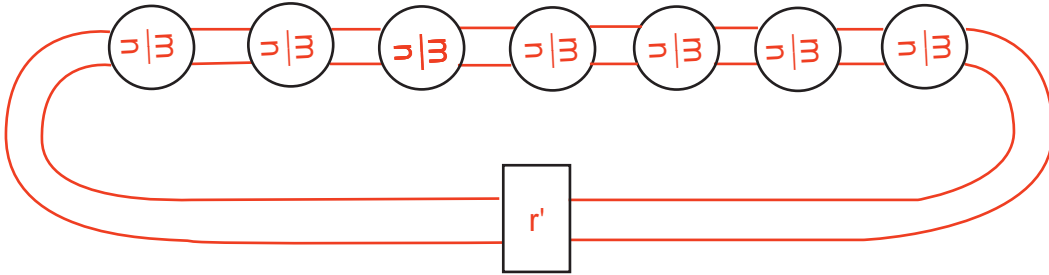

FIGURE 18.

**Theorem 7.1.** *The knots  $K$  and  $K'$  are inequivalent.*

Let  $W, W'$  be the double cover of  $S^3$  branched over  $K, K'$ , respectively. We shall show that  $W$  and  $W'$  are not homeomorphic. Note that  $W'$  is a Seifert fibred manifold with base orbifold  $S^2(m, m, m, m, m, m, m)$ . We will examine  $W$  and show that it cannot be such Seifert manifold.

Let  $\mathcal{T} = (R, t)$  be the tangle shown in Figure 19. Let the boundary components of  $R$  be  $S, S_1, S_2, S_3$  as shown. Note that  $|t \cap S| = 6$  and  $|t \cap S_i| = 4$ ,  $i = 1, 2, 3$ . Let  $X$  be the double branched cover of  $\mathcal{T}$ . Then  $\partial X = G \amalg \coprod_{i=1}^3 T_i$ , where  $G$  is the double branched cover of  $(S, S \cap t)$  and  $T_i$  the double branched cover of  $(S_i, S_i \cap t)$ ,  $i = 1, 2, 3$ ; thus  $G$  has genus 2 and the  $T_i$  are tori.



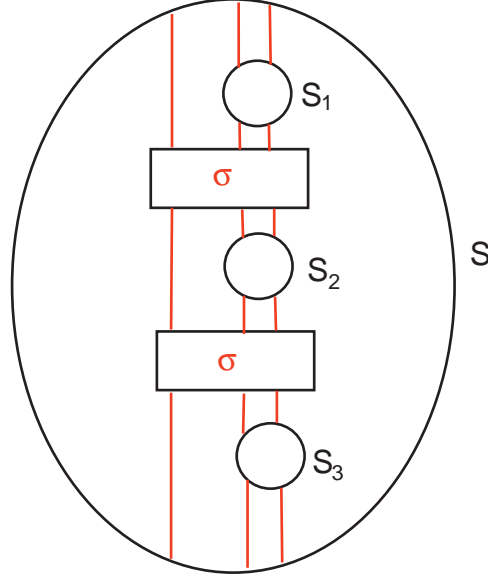

FIGURE 19.

**Remark 7.2.** The permutation induced by  $\sigma$  takes 1 to 2 or 3, since  $K$  is connected.

**Proposition 7.3.**  $X(a/b, a/b, a/b)$  is either

- (1) boundary-irreducible; or
- (2) the boundary connected sum of two copies of a Seifert fibred manifold with base orbifold  $D^2(a, d)$ ,  $d > 1$ ; or
- (3) a handlebody of genus 2.

We prove Proposition 7.3 by successively filling along  $T_1$ ,  $T_3$  and  $T_2$ .

**Lemma 7.4.**  $G$  is incompressible in  $X$ .

*Proof.* Because of Remark 7.2 above, the arrangement of the components of  $t$  with respect to the boundary components of  $R$  is as illustrated schematically in Figure 20. It follows easily that  $\mathcal{T} = (R, t)$  cannot contain any essential disk  $D$  with  $\partial D \subset S$ .  $\diamond$

In the sequel, a “\*” will indicate that the corresponding boundary component is left unfilled.

**Lemma 7.5.**  $G$  is incompressible in  $X(a/b, *, *)$ .

*Proof.* There is an essential annulus  $A_1 \subset R$ , disjoint from  $t$ , with one boundary component in  $S$  and the other having slope  $0/1$  on  $S_1$ ; see Figure 21. A component of the inverse image of  $A_1$  in  $X$  is an essential annulus with one boundary component on  $G$  and the other having slope  $0/1$  on  $T_1$ . Since  $\Delta(a/b, 0/1) = a > 1$ , it follows from [Sh] and Lemma 7.4 that  $G$  is incompressible in  $X(a/b, *, *)$ .  $\diamond$

**Lemma 7.6.**  $G$  is incompressible in  $X(a/b, *, a/b)$ .

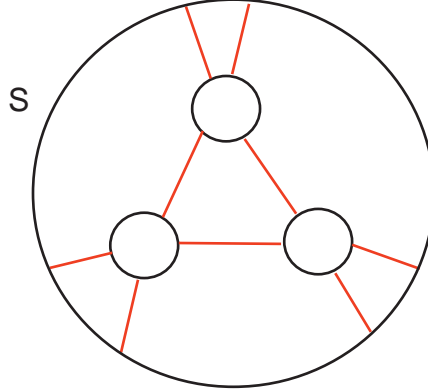

FIGURE 20.

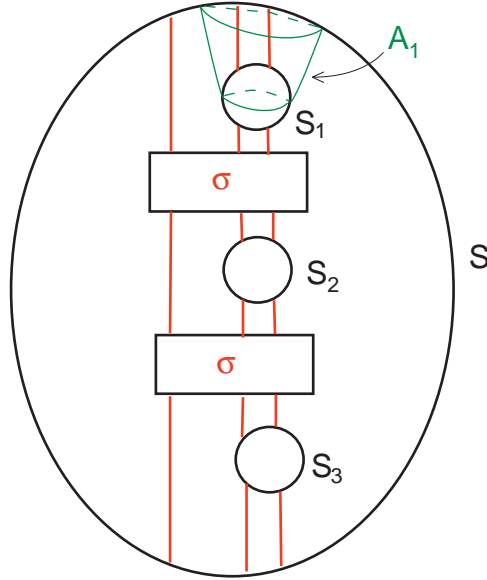

FIGURE 21.

*Proof.* There is an essential annulus  $A_3 \subset R(a/b, *, *)$  with one boundary component on  $S$  and the other having slope  $0/1$  on  $S_3$ . The result now follows as in the proof of the previous lemma.  $\diamond$

*Proof of Proposition 7.3.* There is an essential disk in  $\mathcal{T}(a/b, 0/1, a/b)$ , meeting  $t(a/b, 0/1, a/b)$  in a single point; see Figure 22. Hence  $G$  is compressible in  $X(a/b, 0/1, a/b)$ . Since  $\Delta(a/b, 0/1) = a > 1$ , it follows from Lemma 7.6 and [Wu2] that either  $G$  is incompressible in  $X(a/b, a/b, a/b)$ , or there is an essential annulus  $A \subset X(a/b, *, a/b)$  with one boundary component on  $G$  and the other having slope  $r/s$  on  $T_2$ , where  $\Delta(r/s, 0/1) = \Delta(r/s, a/b) = 1$ . We may assume the latter, in which case, by Dehn twisting  $X(a/b, *, a/b)$  along  $A$ , we have that  $X(a/b, a/b, a/b) \cong X(a/b, 0/1, a/b)$ . From Figure 22 we see that  $X(a/b, 0/1, a/b)$  is the boundary connected sum of two copies of  $Y$ , the double branched cover of the tangle shown in Figure 23.

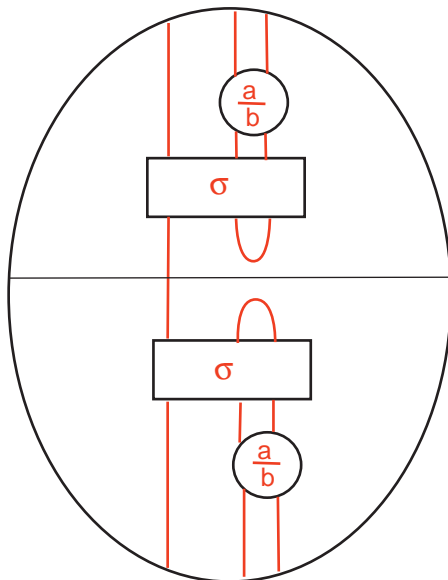

FIGURE 22.

The disk  $D$  shown in Figure 23 separates the tangle into two rational tangles  $\mathcal{R}, \mathcal{R}'$  and lifts to an annulus  $A \subset Y$  which separates  $Y$  into two solid tori  $U$  and  $U'$ , the double branched covers of  $\mathcal{R}, \mathcal{R}'$  respectively. Note that  $A$  has winding number  $a$  in  $U$ . Also, it is easy to see (by Remark 7.2) that  $A$  is not meridional on  $U'$ . Hence  $Y$  is either a Seifert fibre space with base orbifold  $D^2(a, d)$ , for some  $d > 1$ , or a solid torus, giving conclusions (2) and (3) respectively.  $\diamond$

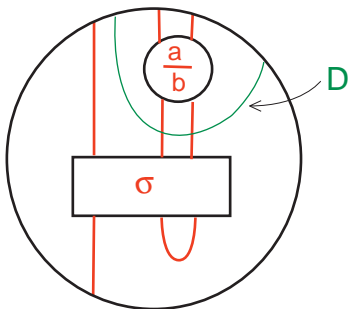

FIGURE 23.

Let  $Z$  be the double branched cover of the tangle  $(Q, s)$  shown in Figure 24. Then  $\partial Z$  has one torus component and two genus two components.

**Lemma 7.7.**  $Z(a/b)$  has incompressible boundary.

*Proof.* For  $i = 0, 1$ , there is an annulus  $A_i \subset Q$ , disjoint from  $s$ , with one boundary component on  $S_i$  and the other having slope  $0/1$  on  $S$ , as shown in Figure 24. Since  $\Delta(a/b, 0/1) = a > 1$ , the result follows as in the proof of Lemma 7.5.  $\diamond$

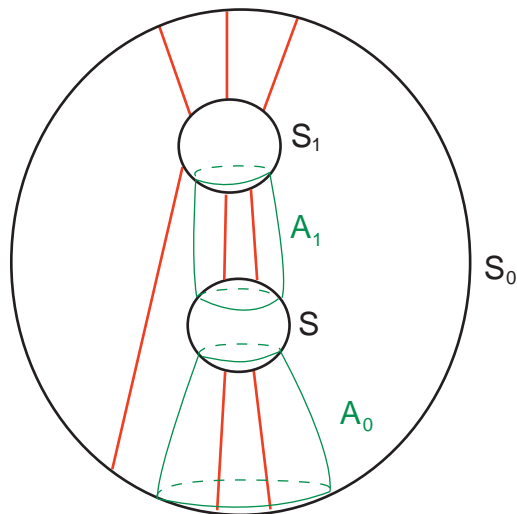

FIGURE 24.

Note that filling  $(Q, s)$  along  $S$  with the rational tangle  $\mathcal{R}(1/0)$  gives a product tangle; hence  $Z \cong G \times I - \text{int } N(C)$ , where  $G$  is a surface of genus two and  $C$  is a simple closed curve  $\subset G \times \{1/2\}$ .

**Proposition 7.8.** *The double branched cover  $W$  of  $(S^3, K)$  either*

- (1) *contains a separating incompressible surface of genus 2; or*
- (2) *contains four disjoint tori, each cutting off a manifold which is Seifert fibred over  $D^2(a, d)$ ,  $d > 1$ ; or*
- (3) *has Heegaard genus at most 3.*

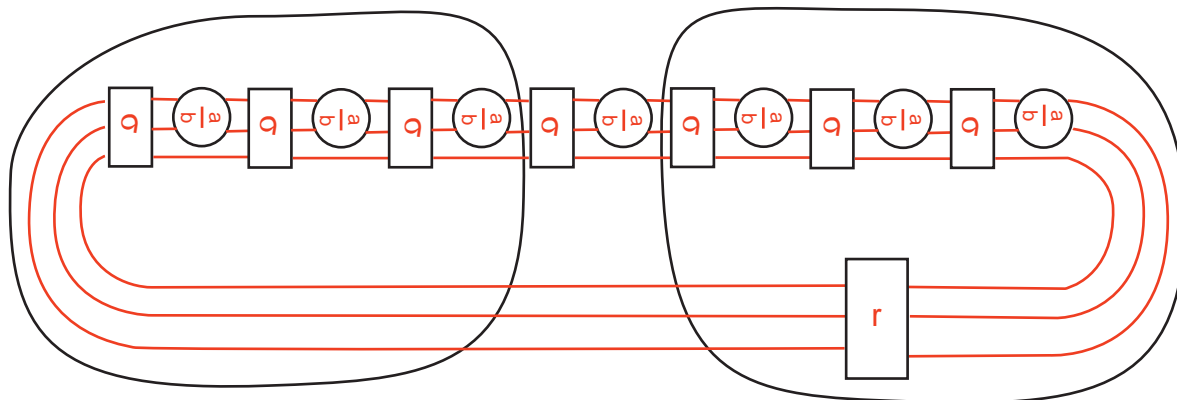

FIGURE 25.

*Proof.* From Figure 25 we see that  $W \cong P \cup_G Z(a/b) \cup_{G'} P'$ , where  $P$  and  $P'$  are copies of  $X(a/b, a/b, a/b)$ .

Case (1) of Proposition 7.3, together with Lemma 7.7, gives conclusion (1).

In Case (2) of Proposition 7.3, each of  $P, P'$  contains two disjoint tori, each cutting off a manifold which is Seifert fibred over  $D^2(a, d)$ , and we have conclusion (2).

In Case (3) of Proposition 7.3,  $P$  and  $P'$  are handlebodies of genus 2. Also, by the remark after the proof of Lemma 7.7,  $Z(a/b)$  is obtained from  $G \times I$  by Dehn surgery on a curve in  $G \times \{1/2\}$ . Hence  $W$  is obtained from a closed manifold with a Heegaard splitting of genus 2 by a Dehn surgery on a curve in the Heegaard surface. Since such a curve has tunnel number at most 2,  $W$  has Heegaard genus at most 3.  $\diamond$

*Proof of Theorem 7.1.* To get a contradiction, suppose  $W \cong W'$ .

Recall that  $W'$  is the double branched cover of  $(S^3, K')$  and is a Seifert fibred space with base orbifold  $S^2(m, m, m, m, m, m, m)$ .

In Case (1) of Proposition 7.8,  $W'$  would contain a separating incompressible surface of genus 2. This surface would have to be horizontal, and would then separate  $W'$  into two twisted  $I$ -bundles. Thus  $W'$  would contain a non-orientable surface. But since  $W'$  is the double branched cover of a knot in  $S^3$ ,  $H_1(W'; \mathbb{Z}/2) = 0$ , a contradiction.

In Case (2) of Proposition 7.8, the tori in question are incompressible (otherwise  $W'$  would have base orbifold  $S^2(a, d, r)$  for some  $r \geq 1$ ). Hence they are vertical in  $W'$ . But since  $W'$  has only 7 exceptional fibres, this is clearly impossible.

Finally, since  $W'$  has base orbifold  $S^2(m, m, m, m, m, m, m)$ , every irreducible Heegaard splitting of  $W'$  is either horizontal or vertical by [MSch]. It also follows from [MSch] that when  $W'$  has an irreducible horizontal Heegaard splitting, its genus is bigger than 6 and that any irreducible vertical Heegaard splitting of  $W'$  has genus 6. Hence Case (3) of Proposition 7.8 is impossible.  $\diamond$

## 8. THE CASE $\Delta(\alpha, \beta) = 5$ AND $M(\alpha)$ IS A LENS SPACE

In this section we suppose that assumptions 5.1 hold and show that  $M(\alpha)$  cannot be a lens space, thus completing our proof of Baker's theorem [Ba]. As we noted at the end of §5, it suffices to show that the link depicted in Figure 3, considered as lying in a Heegaard solid torus in  $L(5, 2q)$ , is not isotopic to either the core of a Heegaard solid torus or the boundary of a Möbius band spine of a Heegaard solid torus.

The proof of the following lemma is straightforward.

**Lemma 8.1.** *Let  $V_1$  be a Heegaard solid torus in a lens space  $L(p, q)$  and let  $K$  be either a core of  $V_1$  or a  $(2, k)$ -cable of a core of  $V_1$ . In the first case assume that  $p$  is odd. Then the double branched cover of  $(L(p, q), K)$  is a lens space.  $\diamond$*

**Remark 8.2.** The condition that  $p$  be odd in the first case is needed to guarantee the existence of a double branched cover. Furthermore, in that case we have  $L(p, q) \cong L(p, 2r) \cong L(p, 2r')$ , where  $4rr' \equiv 1 \pmod{p}$ , and then the double branched cover is homeomorphic to either  $L(p, r)$  or  $L(p, r')$ .

**Lemma 8.3.** *Let  $Q$  be a once-punctured torus bundle over  $S^1$ , with  $\beta$  the boundary slope of the fibre, and let  $\gamma$  be a slope on  $\partial Q$  such that  $Q(\gamma)$  is reducible. Then  $\Delta(\beta, \gamma) = 1, 2, 3, 4$  or  $6$ .*

*Proof.* We consider separately three possibilities for  $Q$ .

(1)  $Q$  is hyperbolic. Here  $\Delta(\beta, \gamma) = 1$  by [BZ1, Lemma 4.1].

(2)  $Q$  is Seifert fibred. In this case the monodromy of the bundle has finite order,  $d$ , say, where  $d = 1, 2, 3, 4$  or  $6$ . If  $Q(\gamma)$  is reducible then  $\gamma$  is the Seifert fibre slope, and hence  $\Delta(\beta, \gamma) = d$ .

(3)  $Q$  is toroidal and not Seifert fibred. Let  $T_0$  be the once-punctured torus fibre of  $Q$ . Here the monodromy of the bundle is  $\pm$  the  $r$ th. power of a Dehn twist along an essential loop  $x$  in  $T_0$ , where  $r \neq 0$  and  $+/-$  denotes composition with the identity and the elliptic involution, respectively. The free group  $\pi_1(T_0)$  has basis  $\{x, y\}$  with  $[\partial T_0] = [x, y] = xyx^{-1}y^{-1}$ . Then  $\pi_1(Q)$  has presentation

$$(i) \quad \langle x, y, t : t^{-1}xt = x, t^{-1}yt = yx^r \rangle$$

or

$$(ii) \quad \langle x, y, t : t^{-1}xt = (xy)x^{-1}(xy)^{-1}, t^{-1}yt = x(x^{-r}y^{-1})x^{-1} \rangle$$

in the  $+/-$  cases mentioned above. In both cases  $\pi_1(\partial Q) = \langle t, [x, y] \rangle$ .

For the proof in this case we will use the following lemma.

**Lemma 8.4.** *If  $A * B$  is a non-trivial free product quotient of  $\pi_1(Q)$ , then  $4t = 0 \in H_1(A * B)$ .*

*Proof.* Let  $A * B$  be a quotient of  $\pi_1(Q)$  with  $A \neq 1 \neq B$ . We adopt the convention that a word in  $x, y$  and  $t$  denotes the image in  $A * B$  of the corresponding element of  $\pi_1(Q)$ .

**Case (i).** Here  $x$  and  $t$  commute. Hence either

- (a)  $x$  and  $t$  are powers of some element  $z$ , or
- (b)  $x$  and  $t$  lie in a conjugate of a factor.

In subcase (a) we have  $x = z^m, t = z^n$ , say. The second relation in the presentation (i) gives  $z^{-n}yz^n = yz^{rm}$ , and therefore  $y^{-1}z^n y = z^{n-rm}$ . By applying an inner automorphism of  $A * B$  we may assume that  $z$  is represented by a cyclically reduced word in the factors. It follows that  $|n| = |n - rm|$ , otherwise we have two cyclically reduced words,  $z^n$  and  $z^{n-rm}$ , of different lengths in the same conjugacy class. Hence either  $m = 0$  or  $y^{-1}z^n y = z^{-n}$ . If  $m = 0$  then  $x = 1$  and so  $A * B$  is a quotient of  $\langle y, t : t^{-1}yt = y \rangle \cong \mathbb{Z} \times \mathbb{Z}$ , a contradiction. If  $y^{-1}z^n y = z^{-n}$  then  $y^{-1}ty = t^{-1}$  and so  $2t = 0 \in H_1(A * B)$ .

In subcase (b) we may assume, by applying an inner automorphism of  $A * B$ , that  $x, t \in A$ . Then  $y^{-1}t^{-1}y = x^r t^{-1} \in A$ . But  $t^{-1} \in A$ , and hence  $y \in A$ . Therefore  $B = 1$ , a contradiction.

**Case (ii).** Let  $s = txy$ . Then  $\pi_1(Q)$  has the presentation

$$\langle x, y, s : s^{-1}xs = x^{-1}, s^{-1}ys = y^{-1}x^{-r} \rangle$$

Since  $x$  and  $s^2$  commute, either

- (a)  $x$  and  $s^2$  are powers of some element  $z$ , or
- (b)  $x$  and  $s^2$  lie in a conjugate of a factor.

In subcase (a), suppose  $x = z^m$ ,  $s^2 = z^n$ . The second relation in the presentation of  $\pi_1(Q)$  implies  $s^{-2}ys^2 = x^ryx^r$ , i.e.  $z^{-n}yz^n = z^{rm}yz^{rm}$ , giving  $y^{-1}z^{(n+rm)}y = z^{n-rm}$ . As in Case (i) we may assume that  $z$  is cyclically reduced, and hence  $|n + rm| = |n - rm|$ , i.e. either  $m = 0$  or  $n = 0$ . If  $m = 0$  then  $x = 1$  and so  $A * B$  is a quotient of the Klein bottle group  $\langle y, s : s^{-1}ys = y^{-1} \rangle$ , which is easily seen to imply  $A * B \cong \mathbb{Z}_2 * \mathbb{Z}_2$ . If  $n = 0$  then  $s^2 = 1$ . Hence  $2s = 0 \in H_1(A * B)$ . But in  $H_1(Q)$   $s = t + x + y$ ,  $2x = 0$ , and  $4y = 0$ . Therefore  $4t = 0 \in H_1(A * B)$ .

In subcase (b) we may assume that  $x, s^2 \in A$ . Hence  $s \in A$ . From the second relation in the above presentation of  $\pi_1(Q)$  we get  $(ys^{-1})^2 = x^{-r}s^{-2} \in A$ . Therefore  $ys^{-1} \in A$ , and hence  $y \in A$ . This implies that  $B = 1$ , a contradiction.  $\diamond$

We now complete the proof of Lemma 8.3.

Let  $\Delta = \Delta(\beta, \gamma)$ . Then  $\pi_1(Q(\gamma))$  is obtained from  $\pi_1(Q)$  by adding the relation  $t^\Delta[x, y]^q = 1$ , for some integer  $q$  coprime to  $\Delta$ . It is easy to see from the presentations (i) and (ii) that  $H_1(Q(\gamma)) \not\cong \mathbb{Z}$ . Therefore  $Q(\gamma)$  is a non-trivial connected sum and hence  $\pi_1(Q(\gamma))$  is a non-trivial free product. The relation  $t^\Delta[x, y]^q = 1$  shows that  $t$  has order  $\Delta$  in  $H_1(Q(\gamma))$ . Hence by Lemma 8.4,  $\Delta$  divides 4.  $\diamond$

Now we complete the proof that  $M(\alpha)$  cannot be a lens space under the assumption that the conditions 5.1 hold. Suppose otherwise. By Lemma 5.10,  $M(\alpha)/\tau_\alpha \cong L(5, 2q)$ ,  $L$  is either the core of a Heegaard solid torus in  $L(5, 2q)$  or a  $(2, k)$ -cable of such a core, and furthermore  $L(5, 2q)$  has a genus 1 Heegaard splitting  $V \cup V_0$  such that  $L$  is isotopic to a curve in  $V$  of the form shown in Figure 3, where  $a$  and  $b$  are coprime integers with  $a \geq 2$  and  $\sigma$  is a 3-braid. We will show that these conditions on  $L$  lead to a contradiction.

Remove from the solid torus  $V$  in Figure 3 the interior of the 3-ball  $B$  containing the  $a/b$ -rational tangle. We then get a tangle  $\mathcal{T}$  in  $Y = (V - \text{int } B) \cup V_0 = L(5, 2q) \setminus \text{int } B$ . Let  $X$  be the double branched cover of  $(Y, \mathcal{T})$ .

Since  $\mathcal{T}(a/b) = L$ , by Lemma 8.1 we have

- $X(a/b)$  is a lens space.

Also, clearly  $\mathcal{T}(0/1) = (\text{core of } V) \# (\text{knot in } S^3)$ , so

- $X(0/1) \cong L(5, r) \# N$  for some closed 3-manifold  $N$ .

**Lemma 8.5.**  $X(1/k)$  is irreducible for all  $k \in \mathbb{Z}$ .

*Proof.*  $\mathcal{T}(1/k)$  is (the 3-braid  $\sigma_1^k \sigma$  in  $V$ )  $\cup V_0$ . Hence  $X(1/k) = Q_k \cup \tilde{V}_0$ , where  $Q_k$  is the double branched cover of  $(V, \sigma_1^k \sigma)$  and  $\tilde{V}_0$  is a solid torus. Now  $Q_k$  is a  $T_0$ -bundle over  $S^1$ , where  $T_0$  is the double branched cover of  $(D^2, 3 \text{ points})$ , i.e. a once-punctured torus. Let  $\beta$  be the boundary slope of the fibre of  $Q_k$ ; note that  $\beta$  projects to the meridian  $\mu$  of  $V$ . Let  $\mu_0, \tilde{\mu}_0$  be the meridians of  $V_0, \tilde{V}_0$ , respectively. Since  $\Delta(\mu, \mu_0) = 5$ , we have  $\Delta(\beta, \tilde{\mu}_0) = 5$ . Hence by Lemma 8.3,  $X(1/k)$  is irreducible.  $\diamond$

There is a  $\mathbb{Z}/2$ -action on  $X$  with quotient  $Y = L(5, 2q) \setminus \text{int } B$ . It follows easily that  $X$  is not a solid torus. We consider the following three possibilities for  $X$ .

- (1)  *$X$  is reducible.* Here we must have  $X \cong X' \# X(a/b)$ , where  $X'(a/b) \cong S^3$ . By Lemma 8.5,  $X'(1/k) \cong S^3$  for infinitely many  $k$ , and hence  $X'$  is a solid torus with meridian  $0/1$ . Since  $\Delta(a/b, 0/1) = a > 1$ , this contradicts the fact that  $X'(a/b) \cong S^3$ .
- (2)  *$X$  is irreducible and not Seifert fibred.* Since  $\Delta(a/b, 0/1) = a > 1$ , the forms of  $X(a/b)$  and  $X(0/1)$  stated above contradict [CGLS] if  $N \cong S^3$  and [BZ2, Corollary 1.4] otherwise.
- (3)  *$X$  is Seifert fibred with incompressible boundary.*

If  $X$  is not the twisted  $I$ -bundle over the Klein bottle let  $\varphi$  be the slope on  $\partial X$  of the Seifert fibre in the unique Seifert fibring of  $X$ . If  $X$  is the twisted  $I$ -bundle over the Klein bottle let  $\varphi$  be the slope of the Seifert fibre in the Seifert structure on  $X$  with orbifold  $D^2(2, 2)$ . In both cases,  $\varphi$  is the only slope on  $\partial X$  such that  $X(\varphi)$  is a non-trivial connected sum. Therefore, if  $N \not\cong S^3$ , then  $\varphi = 0/1$ . But  $X(a/b)$  is a lens space, and so  $\Delta(a/b, 0/1) = 1$ , contradicting our assumption that  $a > 1$ . Hence  $N \cong S^3$ , and so  $\Delta(a/b, \varphi) = \Delta(0/1, \varphi) = 1$ . In particular  $\varphi = 1/s$  for some integer  $s$ . Therefore  $X(1/s)$  is reducible. But this contradicts Lemma 8.5.  $\diamond$

## 9. THE CASE $\Delta(\alpha, \beta) = 6$ AND THE INVOLUTION $\tau_\alpha$ REVERSES THE ORIENTATIONS OF THE SEIFERT FIBRES OF $M(\alpha)$

In this section we suppose that assumptions 5.1 hold and show that it is impossible for  $\Delta(\alpha, \beta)$  to be 6 and for  $\tau_\alpha$  to reverse the orientations of the Seifert fibres of  $M(\alpha)$ . We assume otherwise in order to obtain a contradiction. Here  $M(\alpha)/\tau_\alpha = L(3, q) \cong L(3, 1)$ . By Lemma 5.9,  $L$  is as shown in Figure 3. By Lemma 5.2 parts (2) and (3),  $n$  is even,  $m$  is odd,  $|L| = 1$ , and  $L_\alpha = L \cup K_\alpha$  is as shown in Figure 1. Since  $L$  is a component of  $L_\alpha$ , we see that  $L$  is a core of some Heegaard solid torus of  $L(3, 1)$ . Hence the double branched cover of  $(L(3, 1), L)$  is homeomorphic to  $L(3, 1)$ .

Let  $Y, \mathcal{T}, X$  be as in the previous section, with  $L(5, 2q)$  replaced by  $L(3, 1)$ . Again as in that proof, here we have  $X(a/b) \cong L(3, 1)$  and  $X(0/1) \cong L(3, 1) \# N$  for some closed 3-manifold  $N$ . In the current situation we only have the following weaker version of Lemma 8.5.

**Lemma 9.1.**  *$X(1/k)$  is irreducible for infinitely many  $k \in \mathbb{Z}$ .*



*Proof.* As in the proof of Lemma 8.5,  $\mathcal{T}(1/k)$  is (the 3-braid  $\sigma_1^k \sigma$  in  $V$ )  $\cup V_0$ , and  $X(1/k) = Q_k \cup \tilde{V}_0$ , where  $Q_k$  is the double branched cover of  $(V, \sigma_1^k \sigma)$  and  $\tilde{V}_0$  is a solid torus. Now  $Q_k$  is a  $T_0$ -bundle over  $S^1$ , where  $T_0$  is a once-punctured torus. If  $\rho \in B_3$ , let  $\tilde{\rho}$  denote the corresponding homeomorphism  $T_0 \rightarrow T_0$ . Then  $\tilde{\sigma}_1$  and  $\tilde{\sigma}_2$  are Dehn twists about a pair of curves in  $T_0$  with intersection number 1. With respect to this basis,  $\tilde{\rho}$  defines an element of  $SL_2(\mathbb{Z})$ . Note that since  $L$  is connected,  $\sigma$  is not a power of  $\sigma_1$ . The elements of  $SL_2(\mathbb{Z})$  corresponding to  $\tilde{\sigma}_1^k$  and  $\tilde{\sigma}$  are therefore  $\begin{bmatrix} 1 & k \\ 0 & 1 \end{bmatrix}$  and  $\begin{bmatrix} a & b \\ c & d \end{bmatrix}$ , say, where  $c \neq 0$ . Then the matrix corresponding to  $\tilde{\sigma}_1^k \tilde{\sigma}$  has trace  $a + d + kc$ , which has absolute value greater than 2 for all but at most five values of  $k$ . For such  $k$  the manifold  $Q_k$  is therefore hyperbolic.

Let  $\beta$  be the boundary slope of the fibre of  $Q_k$ ; note that  $\beta$  projects to the meridian  $\mu$  of  $V$ . Let  $\mu_0, \tilde{\mu}_0$  be the meridians of  $V_0, \tilde{V}_0$ , respectively. Since  $\Delta(\mu, \mu_0) = 3$ , we have  $\Delta(\beta, \tilde{\mu}_0) = 3$ . If  $Q_k$  is hyperbolic, then by [BZ1, Lemma 4.1]  $Q_k(\gamma)$  reducible implies  $\Delta(\beta, \gamma) = 1$ . Therefore  $X(1/k) = Q_k(\tilde{\mu}_0)$  is irreducible for infinitely many  $k$ .  $\diamond$

As in the previous section, we have possibilities (1), (2) and (3) for  $X$ . Cases (1) and (2) are ruled out exactly as before (applying Lemma 9.1 instead of Lemma 8.5). In case (3) we may conclude that both  $X(a/b)$  and  $X(0/1)$  are  $L(3, 1)$ ,  $X(1/s)$  is reducible for some integer  $s$  and  $\Delta(\beta, \tilde{\mu}_0) = 3$ . The proof of Lemma 8.3 shows that the monodromy of the once-punctured torus bundle  $Q_s$  has order 3. Therefore  $Q_s$  has base orbifold  $D^2(3, 3)$ , and so  $X(1/s) \cong Q_s(\tilde{\mu}_0) \cong L(3, q_1) \# L(3, q_2)$ . This implies that  $X$  has base orbifold  $D^2(3, 3)$ . But then no two distinct fillings on  $X$  can give the lens space  $L(3, 1)$ , yielding a contradiction.

10. THE CASE  $\Delta(\alpha, \beta) = 5$  AND THE INVOLUTION  $\tau_\alpha$  REVERSES THE ORIENTATIONS OF THE SEIFERT FIBRES OF  $M(\alpha)$

In this section we suppose that assumptions 5.1 hold and show that it is impossible for  $\Delta(\alpha, \beta)$  to be 5 and for  $\tau_\alpha$  to reverse the orientations of the Seifert fibres of  $M(\alpha)$ . We assume otherwise in order to obtain a contradiction.

As in section 7, we just need to show that the two knots,  $K, K'$ , shown in Figures 26 and 27 respectively are inequivalent in  $S^3$ .

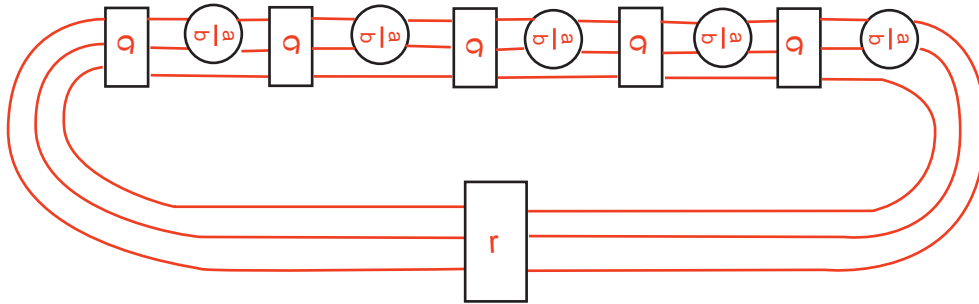

FIGURE 26.

**Theorem 10.1.** *The knots  $K$  and  $K'$  are inequivalent.*

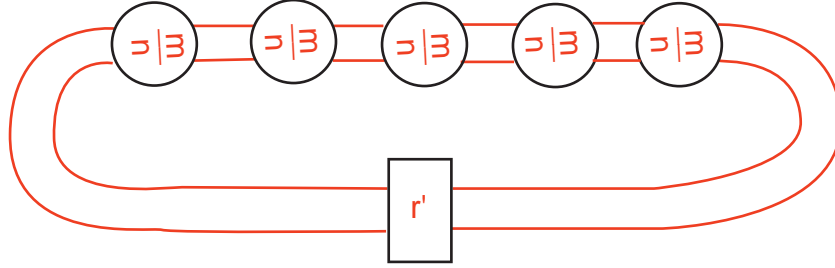

FIGURE 27.

As in Subsection 7, we will show that the double branched covers  $W, W'$  of  $(S^3, K), (S^3, K')$  are not homeomorphic.

Here we consider the tangle  $\mathcal{T} = (R, t)$  shown in Figure 28, with double branched cover  $X$ . Let the boundary components of  $R$  be  $S, S_1, S_2$  (see Figure 28), and the corresponding boundary components of  $X$  be  $G, T_1, T_2$ , so that  $T_1$  and  $T_2$  are tori and  $G$  has genus two.

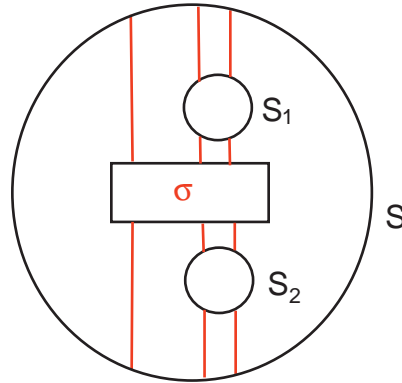

FIGURE 28.

**Lemma 10.2.** *If  $G$  is compressible in  $X$  then  $\mathcal{T}$  is isotopic to the tangle shown in Figure 29.*

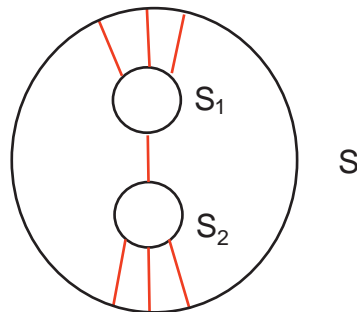

FIGURE 29.

*Proof.* Since  $t \cup S_1 \cup S_2$  is connected, any essential disk  $D$  in  $\mathcal{T}$  with  $\partial D \subset S$  must meet  $t$  in a single point. Hence  $D$  meets the unique strand of  $t$  connecting  $S_1$  and  $S_2$ , decomposing  $\mathcal{T}$  into

two tangles  $\mathcal{T}_1$  and  $\mathcal{T}_2$ . We claim that each of  $\mathcal{T}_1$  and  $\mathcal{T}_2$  is a product tangle. To see this, note that deleting the strand of  $t$  that joins  $S_2$  to  $S$  and runs through the braid  $\sigma$  gives the tangle shown in Figure 30. It follows that  $\mathcal{T}_1$  is as stated. Similarly,  $\mathcal{T}_2$  is also a product tangle.  $\diamond$

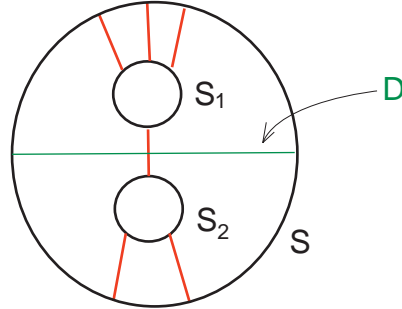

FIGURE 30.

**Corollary 10.3.** *If  $G$  is compressible in  $X$  then  $X(a/b, a/b)$  is a genus 2 handlebody.*

**Lemma 10.4.** *If  $G$  is incompressible in  $X$  then  $G$  is incompressible in  $X(a/b, a/b)$ .*

*Proof.* This is exactly like the proof of Lemma 7.6 in section 7, using the annuli  $A_1$  and  $A_2$  shown in Figure 31.  $\diamond$

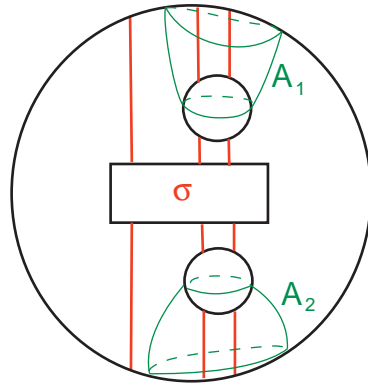

FIGURE 31.

**Proposition 10.5.**  *$W$  either*

- (1) *contains a separating incompressible surface of genus 2; or*
- (2) *has Heegaard genus at most 3.*

*Proof.* From Figure 32 we see that  $W \cong U \cup_G Z(a/b) \cup_{G'} U'$ , where  $U$  and  $U'$  are copies of  $X(a/b, a/b)$ .

If  $G$  is incompressible in  $X$  then we get conclusion (1) by Lemmas 10.4 and 7.7.

If  $G$  is compressible in  $X$  then we get conclusion (2) by Corollary 10.3 and the proof of part (3) of Proposition 7.8.  $\diamond$

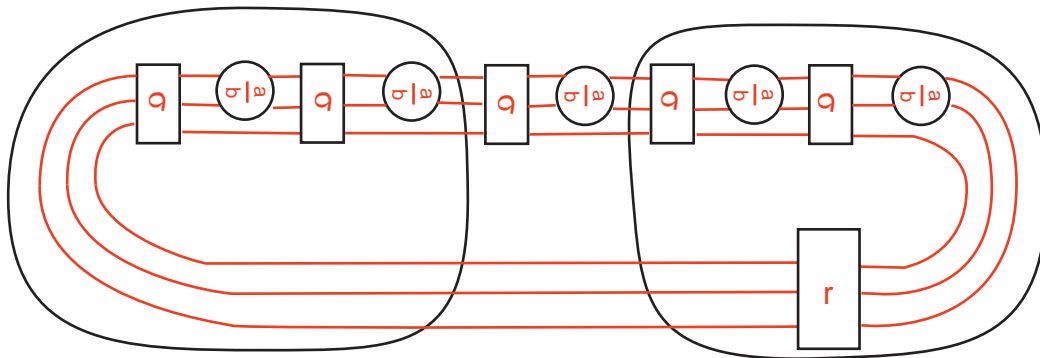

FIGURE 32.

*Proof of Theorem 10.1.* Assume  $W \cong W'$ . Since  $W'$  is a Seifert fibre space over  $S^2$  with 5 exceptional fibres, we get a contradiction to Proposition 10.5 as in the proof of Theorem 7.1 in Cases (1) and (3) of Proposition 7.8.  $\diamond$

11. A FAMILY OF EXAMPLES REALIZING  $\Delta(\alpha, \beta) = 4$

We show in this section that distance 4 between a prism manifold filling slope and a once-punctured torus slope can be realized on infinitely many hyperbolic knot manifolds.

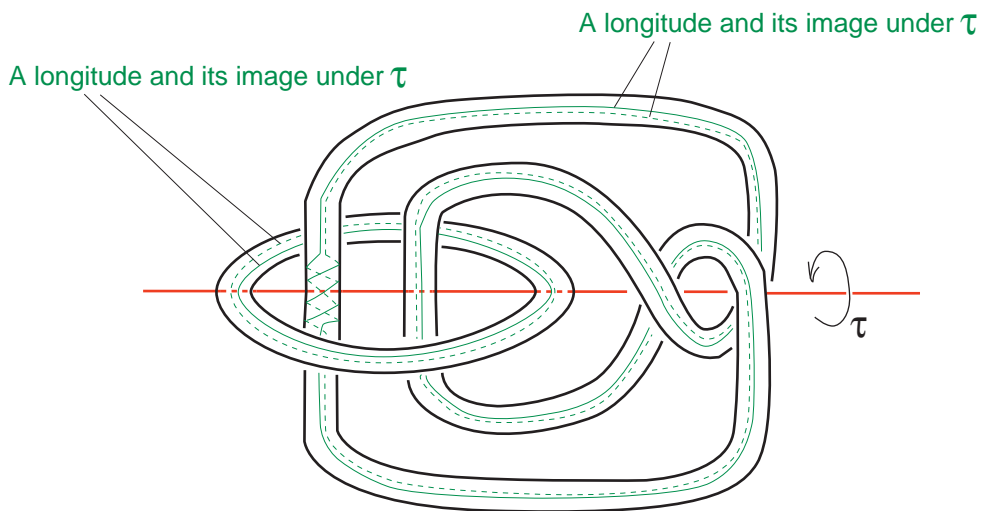

FIGURE 33.

Let  $Wh$  be the exterior of the Whitehead link with standard meridian-longitude coordinates on  $\partial Wh$ . We use  $Wh(\gamma)$  to denote the manifold of Dehn filling one boundary component of  $Wh$  with slope  $\gamma$ , and  $Wh(\gamma, \delta)$  the manifold of Dehn filling one boundary component with slope  $\gamma$  and the other with slope  $\delta$ .

**Theorem 11.1.** *For each integer  $n$  with  $|n| > 1$ ,  $Wh(\frac{-2n \pm 1}{n})$  is a hyperbolic knot manifold whose 0-slope is the boundary slope of an essential once-punctured torus and whose  $-4$ -slope yields a prism manifold whose base orbifold is  $S^2(2, 2, |\mp 2n - 1|)$ .*

*Proof.* It is well known that  $Wh(\gamma)$  is hyperbolic for each  $\gamma \notin \{-1, -2, -3, -4, 0, 1/0\}$ . That  $Wh(\gamma)$ ,  $\gamma \neq 1/0$ , contains an essential once-punctured torus with boundary slope 0 is obvious from the Whitehead link diagram.

The Whitehead link admits an involution  $\tau$  as shown in Figure 33. This involution restricts to an involution, still denoted  $\tau$ , on  $Wh$  and then extends to an involution  $\tau_\gamma$  on  $Wh(\gamma)$  and to an involution  $\tau_{\gamma,\delta}$  on  $Wh(\gamma, \delta)$  for all slopes  $\gamma$  and  $\delta$ . The quotient space under  $\tau$  is shown in Figure 34. Note that the branch set of  $Wh(\gamma)/\tau_\gamma$  is obtained by removing the two  $1/0$ -tangles in Figure 34 and then filling one  $\gamma$ -tangle. Figure 35 shows the branch set in  $Wh(-4)/\tau_{-4}$  and Figure 36 shows the branch set in  $Wh(\frac{-2n\pm 1}{n}, -4)/\tau_{\frac{-2n\pm 1}{n}, -4}$ . As the branch set in  $Wh(\frac{-2n\pm 1}{n}, -4)/\tau_{\frac{-2n\pm 1}{n}, -4} = S^3$  is a Montesinos link of type  $(2, 2, \frac{\mp 2n-1}{2})$ , the double branched cover  $Wh(\frac{-2n\pm 1}{n}, -4)$  is a prism manifold whose base orbifold is  $S^2(2, 2, |\mp 2n - 1|)$ .  $\diamond$

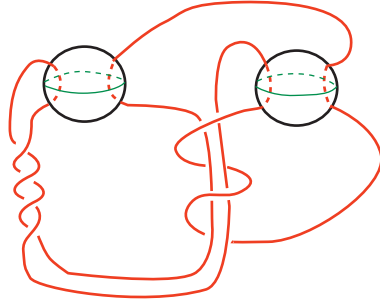

FIGURE 34.

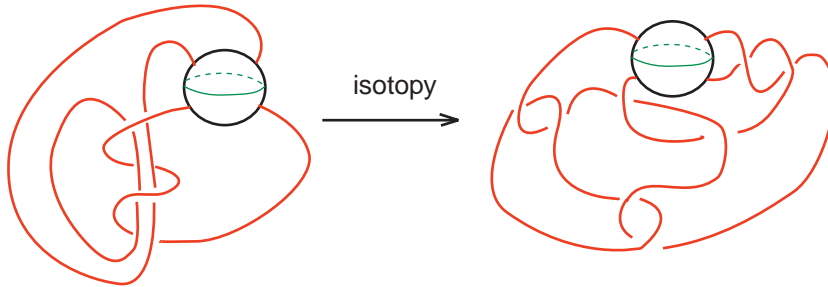

FIGURE 35.

## 12. THE CASE WHEN $\Delta(\alpha, \beta) = 4$ AND $M(\alpha)$ IS A PRISM MANIFOLD

In this section we show

**Theorem 12.1.** *Let  $M$  be a hyperbolic knot exterior containing an essential once-punctured torus with slope  $\beta$ . If  $M(\alpha)$  is a prism manifold with  $\Delta(\alpha, \beta) = 4$ , then  $M$  is one of the examples given in §11, that is,  $(M; \alpha, \beta) \cong (Wh(\frac{-2n \pm 1}{n}); -4, 0)$  for some integer  $n$  with  $|n| > 1$ .*

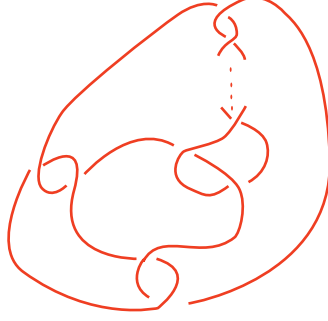

FIGURE 36.

Let  $F$  be an essential once-punctured torus in  $M$  with slope  $\beta$ . Choose a Klein bottle  $\hat{P}$  in  $M(\alpha)$  which has the minimal number of intersection components with  $\partial M$  and let  $P = M \cap \hat{P}$ . Then  $p = |\partial P| > 0$  since  $M$  is hyperbolic. The punctured Klein bottle  $P$  is essential in  $M$ , i.e. it is incompressible and boundary-incompressible in  $M$ . The proof of this statement is essentially contained in [Te2, Proofs of Lemmas 2.1 and 2.2] and we only need to add the condition that  $M(\alpha)$  is a prism manifold which is thus irreducible and does not contain a projective plane.

As usual, the two surfaces  $F$  and  $P$  define two labeled intersection graphs which we denote by  $\Gamma_F$  and  $\Gamma_P$ . Then neither  $\Gamma_F$  nor  $\Gamma_P$  contain trivial loops ([Te2, Lemma 3.1] with the same proof). The graph  $\Gamma_F$  has a unique vertex whose valency is  $4p$ , and the graph  $\Gamma_P$  has  $p$  vertices each having valency 4. Note that every edge of  $\Gamma_F$  is positive since  $F$  is orientable and has only one boundary component.

- Lemma 12.2.** (1) When  $p \geq 2$ ,  $\Gamma_F$  has no  $S$ -cycle.  
 (2) When  $p \geq 3$ ,  $\Gamma_F$  has no generalized  $S$ -cycle (See [Te2] for its definition).  
 (3)  $\Gamma_F$  cannot have more than  $\frac{p}{2} + 1$  mutually parallel edges.

*Proof.* Part (1) is [Te2, Lemma 3.2] with the same proof, part (2) is [Te2, Lemma 3.3] with a similar argument plus the fact that  $M(\alpha)$  does not contain projective plane, and part (3) is [LT, Lemma 6.2 (4)] with the same proof.  $\diamond$

**Lemma 12.3.**  $p = 1$ .

*Proof.* The lemma was proved in [Te2, Lemma 5.2] when  $M$  was a genus one non-cabled knot exterior in  $S^3$ , in which case  $p$  was an odd integer. In our situation, we need to extend the argument of [Te2, Lemma 5.2] slightly, using Lemma 12.2 (3) instead of [Te2, Lemma 3.4].

Suppose otherwise that  $p \geq 2$ . The reduced graph  $\bar{\Gamma}_F$  is a subgraph of the graph shown in Figure 37 ([Go1, Lemma 5.1]). In particular  $\bar{\Gamma}_F$  has at most three edges. Suppose these edges of  $\bar{\Gamma}_F$  have weights  $w_k$ ,  $k = 1, 2, 3$ , some of which may possibly be zero. Then  $2(w_1 + w_2 + w_3) = 4p$ . Let  $e_1, \dots, e_{w_k}$  be a parallel family of consecutive edges in  $\Gamma_F$ . Reading the labels around the vertex of  $\Gamma_F$ , we see that the labels of the edges  $e_1, e_2, \dots, e_{w_k}$  are as illustrated in Figure 38.

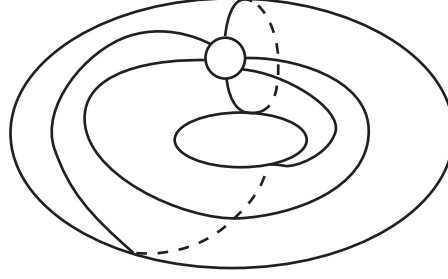

FIGURE 37.

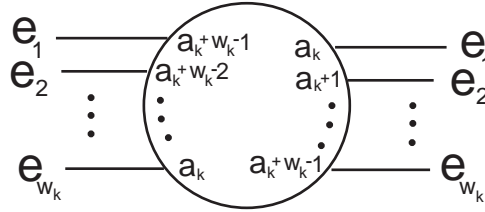

FIGURE 38.

By Lemma 12.2,  $w_k = 0$  or  $1$ ,  $1 \leq k \leq 3$ . (More precisely, this follows from Lemma 12.2 (1) if  $w_k$  is even, Lemma 12.2 (2) if  $w_k$  is odd and  $p \geq 3$ , and Lemma 12.2 (3) if  $w_k$  is odd and  $p = 2$ .) This is a contradiction.  $\diamond$

So  $\Gamma_F$  has exactly two edges and both are level edges (i.e. having the same label at the two endpoints of the edge). Let  $e_1, e_2$  be the two edges of  $\Gamma_F$  and of  $\Gamma_P$ . Note that each  $e_i$  is an orientation-reversing loop in  $P$  by the parity rule.

Since  $\Delta(\alpha, \beta) = 4$ , if the endpoints of the two edges around the vertex  $\partial F$  are labeled consecutively by  $1, 2, 3, 4$ , the labels around  $\partial P$  are also consecutive. It follows from this fact that if the two edges in  $\Gamma_F$  are not parallel, then the two edges in  $\Gamma_P$  must be parallel. Also, combining this fact with the proof of [Te2, Lemma 4.1], we have that the two edges  $e_1$  and  $e_2$  cannot be parallel in both  $\Gamma_P$  and  $\Gamma_F$ . So there are only two possible configurations for the pair of the graphs  $\Gamma_F$  and  $\Gamma_P$ , which we illustrate in Figure 39 and Figure 40 respectively.

Let  $S$  be the frontier of a thin regular neighborhood of  $P$  in  $M$ . Then  $S$  is a separating twice-punctured torus in  $M$ . The surfaces  $F$  and  $S$  define two labeled intersection graphs  $\Gamma'_F$  and  $\Gamma_S$ . Note that  $\Gamma'_F$  is obtained by doubling the edges of  $\Gamma_F$  and  $\Gamma_S$  double covers  $\Gamma_P$ . See Figures 39 and 40 for illustrations of the graphs  $\Gamma_F, \Gamma_P, \Gamma'_F$  and  $\Gamma_S$ .

The surface  $S$  separates  $M$  into two components which we denote by  $X^+$  and  $X^-$ , where  $X^-$  is a twisted  $I$ -bundle over  $P$ . Note that  $\widehat{X}^-$  is a twisted  $I$ -bundle over the Klein bottle  $\widehat{P}$  and

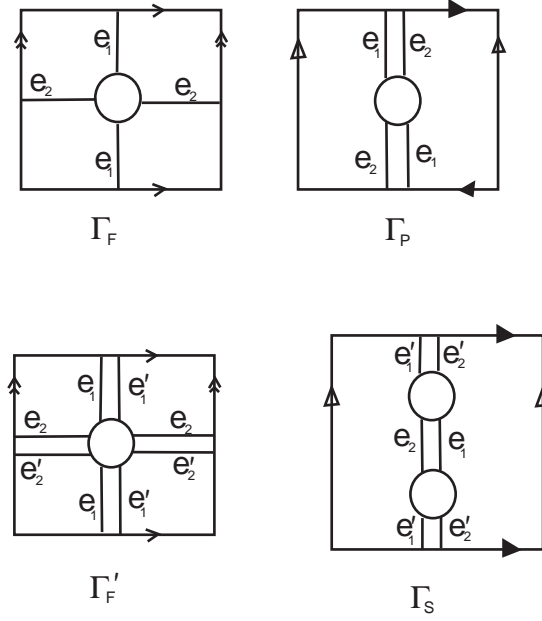

FIGURE 39.

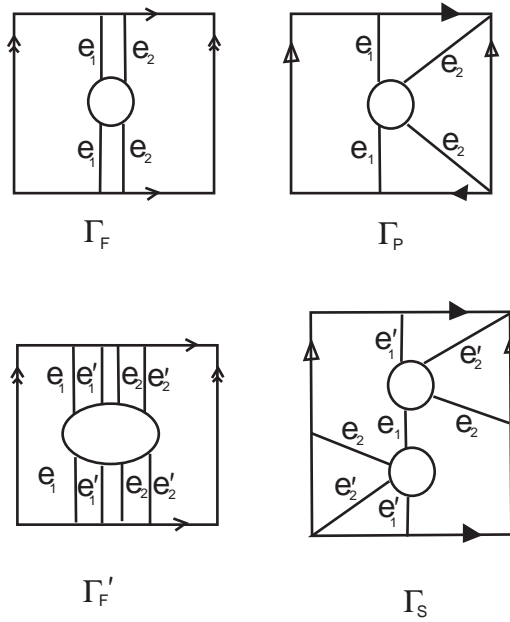

FIGURE 40.

$\widehat{X}^+$  is a solid torus since  $M(\alpha) = \widehat{X}^- \cup \widehat{X}^+$  is a prism manifold. Let  $H^\epsilon$  denote the part of the filling solid torus of  $M(\alpha)$  contained in  $\widehat{X}^\epsilon$ ,  $\epsilon \in \{\pm\}$  and let  $\partial_0 H^\epsilon = \partial H^\epsilon \cap \partial M$ .

We first show

**Lemma 12.4.** *The case given by Figure 39 cannot occur.*



*Proof.* The 4-gon face of  $\Gamma'_F$ , which we denote by  $f$ , is contained in  $X^+$  and its boundary edges form a Scharlemann cycle of order 4. From Figure 39 we see that  $\partial f$  is a non-separating curve in the genus two surface  $S \cup \partial_0 H^+$  and  $\partial f \cap S$  is contained in an essential annulus  $A$  in  $\widehat{S}$ . Let  $U$  be a regular neighborhood of  $A \cup H^+ \cup f$  in  $\widehat{X}^+$ . Then  $U$  is a compact 3-manifold with  $\partial U$  a torus and the fundamental group of  $U$  has the following presentation

$$\langle x, t; x^3txt = 1 \rangle$$

where we take a fat base point in  $\widehat{S}$  containing  $\partial S \cup e_1 \cup e_2$ ,  $x$  is a based loop formed by a cocore arc of  $\partial_0 H^+$  and  $t$  is represented by a core circle of  $A$ . Let  $y = xt$ , then

$$\pi_1(U) = \langle x, y; x^2y^2 = 1 \rangle.$$

So  $U$  is Seifert fibred with base orbifold  $D(2, 2)$ . Thus  $U$  contains a Klein bottle. But  $U$  is contained in the solid torus  $\widehat{X}^+$ . This gives a contradiction.  $\diamond$

So the case of Figure 40 must occur. In this case we are going to show that  $M$  is obtained by Dehn filling one boundary component of the Whitehead link exterior.

In this case, the bigon faces of  $\Gamma'_F$  between  $e_1$  and  $e'_1$  and between  $e_2$  and  $e'_2$  lie in  $X^-$ , and the bigon face between  $e'_1$  and  $e_2$ , which we denote by  $B$ , is contained in  $X^+$ . Let  $Q$  be a regular neighborhood of  $S \cup \partial_0 H^+ \cup B$  in  $X^+$ , and  $\widehat{Q} = Q \cup H^+$ . Then it's easy to see that  $\widehat{Q}$  is a Seifert fibred manifold whose base orbifold is an annulus with a single cone point of order 2. The boundary of  $\widehat{Q}$  consists of two tori, one of which is the torus  $\widehat{S}$ . Let  $T_0$  be the other component. Note that  $T_0$  is contained in the interior of  $X^+$ . Since  $\widehat{X}^+$  is a solid torus,  $T_0$  must bound a solid torus in  $\widehat{X}^+ \setminus \widehat{Q}$ , which we denote by  $N$ .

**Lemma 12.5.** *The Seifert structure of  $\widehat{Q}$  does not match with the Seifert structure of  $\widehat{X}^-$  whose base orbifold is  $D(2, 2)$ .*

*Proof.* The  $S$ -cycle  $\{e_1, e'_1\}$  in  $\Gamma'_F$  implies that as a cycle in  $\Gamma_S$ ,  $e_1 \cup e'_1$  is a fibre of the Seifert structure of  $\widehat{X}^-$  whose base orbifold is  $D(2, 2)$ . Similarly the  $S$ -cycle  $\{e'_1, e_2\}$  in  $\Gamma'_F$  implies that as a cycle in  $\Gamma_S$ ,  $e'_1 \cup e_2$  is a fibre of the Seifert structure of  $\widehat{Q}$ . Obviously from Figure 40 these two cycles have different slopes in  $\widehat{S}$ .  $\diamond$

Let  $W = X^- \cup_S Q$ . Note that  $M = W \cup_{T_0} N$ . So we just need to show that  $W$  is the Whitehead link exterior. We use the notation  $W(\partial M, \gamma)$  to denote the Dehn filling of  $W$  along a slope  $\gamma$  in  $\partial M \subset \partial W$ .

**Lemma 12.6.** (1)  $W$  is irreducible.

(2) The twice-punctured torus  $S$  is incompressible in  $W$ .

(3)  $F \cap W$  has a component which is an essential once-punctured annulus in  $W$  with the puncture lying in  $\partial M$  of slope  $\beta$  and with the boundary of the annulus lying in  $T_0$ .

(4)  $W(\partial M, \alpha)$  contains an essential torus which is  $\widehat{S}$ .

*Proof.* By the construction of  $Q$ , one can easily see that  $Q$  is irreducible and  $S$  is incompressible in  $Q$ . Obviously  $X^-$  is irreducible and  $S$  is incompressible in  $X^-$ . Thus  $S$  is incompressible in  $W = X^- \cup_S Q$  and  $W$  is irreducible. So we get (1) and (2).

Part (3) follows from the graph  $\Gamma'_F$  shown in Figure 40 and the construction of  $Q$ . In fact the exterior in  $F$  of the annulus which is the annulus face of  $\Gamma'_F$  shrunk slightly into the interior of the face is the required punctured annulus. It is incompressible in  $W$  because it is an essential subsurface of  $F$ . It is boundary incompressible in  $W$  because it has only one intersection component with  $\partial M$  and  $M$  does not contain an essential disk with slope  $\beta$ .

For (4), we just need to note that  $W(\partial M, \alpha) = \widehat{X}^- \cup_{\widehat{S}} \widehat{Q}$ .  $\diamond$

**Lemma 12.7.**  *$W$  is hyperbolic.*

*Proof.* We already know that  $W$  is irreducible (Lemma 12.6 (1)). Obviously  $W$  cannot be Seifert fibred since  $M = W \cup N$  is hyperbolic. So we just need to show that  $W$  is atoroidal. Suppose otherwise that  $W$  contains an essential torus  $T$ . Note that  $T$  is separating since  $M$  is hyperbolic.

Note that  $Q$  (a compression body) is of the form  $T_0 \times [0, 1]$  union a 1-handle attached to  $T_0 \times 1$ . It is now easy to see that any incompressible torus in  $Q$  is isotopic into  $T_0 \times [0, 1]$ , and therefore boundary parallel. Hence  $T$  cannot be contained in  $Q$ . Obviously  $X^-$  is atoroidal because it is a twisted  $I$ -bundle over a punctured Klein bottle. So  $T$  cannot be contained in  $X^-$  either. Therefore  $T$  must intersect  $S$ . As  $S$  is incompressible in  $W$  (Lemma 12.6 (2)), we may assume that every component of  $S \cap T$  is a circle which is essential in both  $T$  and  $S$ . As  $S$  is separating,  $T \cap S$  has even number of components. We may further assume that each component of  $T \setminus (S \cap T)$  is an essential annulus in  $(X^-, S)$  or in  $(Q, S)$  (using isotopy of  $T$  to eliminate inessential ones), and thus can be further assumed to be a vertical annulus in the characteristic  $I$ -bundle of  $(X^-, S)$  or  $(Q, S)$ . Note that the characteristic  $I$ -bundle for the pair  $(Q, S)$  is isotopic to a regular neighborhood of  $B \cup \partial_0 H^+$  in  $Q$  such that the horizontal boundary of the  $I$ -bundle is a twice-punctured annulus  $\phi$  contained in  $S$  such that  $\widehat{\phi}$  is an essential annulus in  $\widehat{S}$ , and the vertical boundary of the  $I$ -bundle has two components: one is  $\partial_0 H^+$  and the other is the frontier of the  $I$ -bundle in  $Q$ . So we may assume that  $S \cap T$  is contained in  $\phi$ .

Let  $A$  be a component of  $T \setminus (T \cap S)$ . It's easy to see that  $\partial A$  is  $\widehat{S}$ -essential for otherwise  $A$  would be isotopic to  $\partial_0 H^\epsilon$  and  $T$  would be parallel to  $\partial M$ . Now if  $A$  is contained in  $Q$ , its two boundary components are either isotopic in  $\phi$  to the two inner boundary components of  $\phi$  respectively or bound an annulus in  $\phi$  which separates  $\phi$  into two once-punctured annuli. Moreover  $A$  is a vertical annulus in the Seifert fibred structure of  $\widehat{Q}$ . If  $A$  is contained in  $X^-$ , it is a vertical annulus in one of the two Seifert fibred structures of  $\widehat{X}^-$ . So the Seifert structure of  $\widehat{Q}$  matches a Seifert structure of  $\widehat{X}^-$ . By Lemma 12.5, the Seifert structure of  $\widehat{X}^-$  must be the one whose base orbifold is a Möbius band. Thus if a component  $A$  of  $T \setminus (S \cap T)$  is contained in  $X^-$ , it is a non-separating annulus in  $X^-$ . In particular if  $A$  is contained in  $X^-$ ,  $\partial A$  cannot

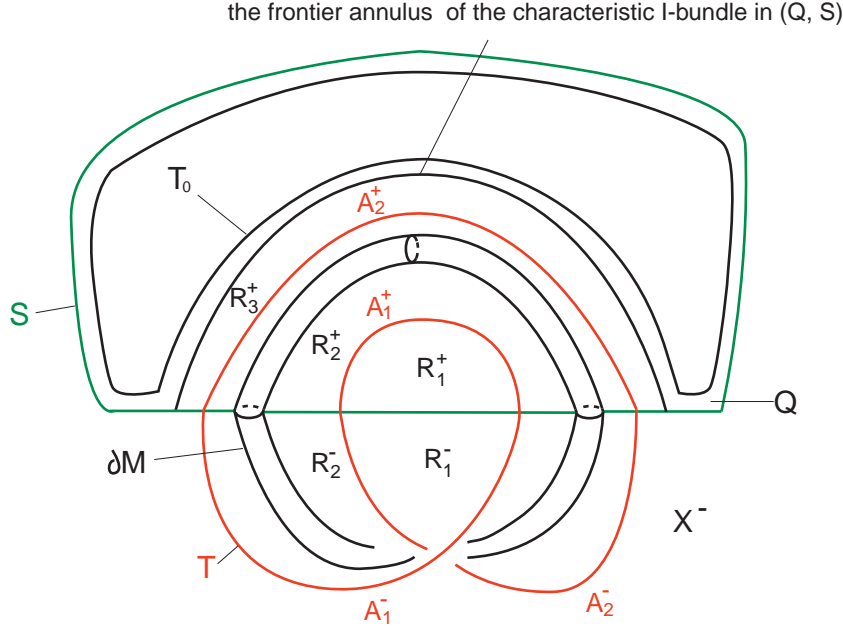

FIGURE 41.

be parallel in  $S$ . For otherwise the union of  $A$  with the annulus in  $S$  bounded by  $\partial A$  would be a Klein bottle in  $W \subset M$ , giving a contradiction.

With the above information we have obtained on the components of  $T \setminus (S \cap T)$  we see that the following case must occur:  $T \setminus (S \cap T)$  has exactly four components, two in  $Q$  which we denote by  $A_1^+$  and  $A_2^+$ , and two in  $X^-$  which we denote by  $A_1^-$  and  $A_2^-$ , and they are connected as shown in Figure 41. More specifically the annuli  $A_1^+$  and  $A_2^+$  separate  $Q$  into three components  $R_1^+, R_2^+, R_3^+$  such that  $R_1^+$  is a solid torus in which  $A_1^+$  has winding number 2,  $R_2^+$  contains  $\partial_0 H^+$  and is a product  $I$ -bundle over a once-punctured annulus, and  $R_3^+$  is a regular neighborhood of  $T_0$ . The annuli  $A_1^-$  and  $A_2^-$  separate  $X^-$  into two components  $R_1^-, R_2^-$  such that  $R_1^-$  contains  $\partial_0 H^-$  and is a product  $I$ -bundle over a once-punctured annulus, and  $R_2^-$  is a solid torus. (cf. Figure 41). Moreover  $R_2^+ \cup R_2^-$  is a once-punctured annulus bundle over  $S^1$  with finite order monodromy and thus is Seifert fibred. In fact one can see that the monodromy has order two. On the other hand  $R_1^+ \cup R_1^- \cup R_3^+$  is Seifert fibred over an annulus with one cone point of order two. Hence  $W$  is a graph manifold. But  $M = W \cup N$  is hyperbolic. We get a contradiction.  $\diamond$

**Lemma 12.8.**  $W(\partial M, \beta)$  contains an essential annulus which is the cap off of the once-punctured annulus given in part (3) of Lemma 12.6.

*Proof.* Note that the punctured annulus given in part (3) of Lemma 12.6 is non-separating in  $W$ . So it caps off to a non-separating annulus in  $W(\partial M, \beta)$ . If this annulus is inessential in  $W(\partial M, \beta)$ , then it must be compressible, from which we may get a compressing disk for  $T_0$  in  $W(\partial M, \beta)$ . That is,  $\beta$  becomes a boundary-reducing Dehn filling slope on  $\partial M$  for  $W$ . On the other hand,  $\alpha$  is a toroidal filling slope on  $\partial M$  for  $W$  by Lemma 12.6 (4). Hence by [GL], we

have  $\Delta(\alpha, \beta) \leq 2$ . But this contradicts the assumption of  $\Delta(\alpha, \beta) = 4$ . Thus the above annulus is essential in  $W(\partial M, \beta)$ .  $\diamond$

Now we have shown that  $W$  is hyperbolic, and for  $(W, \partial M)$ ,  $\alpha$  is a toroidal filling slope and  $\beta$  an annular filling slope. Furthermore  $W(\partial M, \beta)$  contains an essential annulus whose intersection with  $\partial M$  has only one component. Applying [GW2, Theorem 1.1], we see that  $W$  is the Whitehead link exterior.

So  $W \cong Wh$ . By tubing off the once-punctured annulus in  $W$  (given by Lemma 12.6 (3)) with an annulus in  $T_0$ , we get a once-punctured torus in  $(W, \partial M)$  with slope  $\beta$ . So  $\beta$  corresponds to the zero slope with respect to the standard coordinates on  $\partial Wh$ . Similarly we see that  $\alpha$  is the slope  $-4$ . As  $\widehat{Q}$  is Seifert fibred over an annulus with a single cone point,  $\widehat{X}^+ = \widehat{Q} \cup_{T_0} N$  is a solid torus if and only if the filling slope on  $T_0$  is distance one from the Seifert slope of  $\widehat{Q}$  on  $T_0$ . This Seifert slope is unique. From the examples given in §11, we see that the Seifert slope of  $\widehat{Q}$  on  $T_0$  is  $-2$  and those examples are the only examples realizing Theorem 1.3 (1). That is, we have  $(M; \alpha, \beta) \cong (Wh(\frac{-2n \pm 1}{n}); -4, 0)$  for some integer  $n$  with  $|n| > 1$ .

### 13. PROOF OF THEOREMS 1.4 AND 1.5

*Proof of Theorem 1.4.* Let  $M$  be a hyperbolic knot manifold containing an essential once-punctured torus  $F_\beta$  with boundary slope  $\beta$ . Let  $\gamma$  be an exceptional slope on  $\partial M$ .

We may suppose that the capped-off torus  $\widehat{F}_\beta$  is incompressible in  $M(\beta)$  by Proposition 3.1. Now  $M(\gamma)$  is either reducible, small Seifert, or toroidal. In the first case  $\Delta(\beta, \gamma) = 1$  by [BZ1, Lemma 4.1], while in the second case Theorem 1.3 implies that  $\Delta(\beta, \gamma) \leq 5$  with equality only if  $(M; \gamma, \beta) \cong (Wh(-3/2); -5, 0)$  and  $M(\gamma)$  has base orbifold  $S^2(2, 3, 3)$ , and  $\Delta(\beta, \gamma) = 4$  only if  $(M; \gamma, \beta) \cong (Wh(\frac{-2n \pm 1}{n}); -4, 0)$  for some integer  $n$  with  $|n| > 1$  and  $M(\gamma)$  has base orbifold  $S^2(2, 2, |\mp 2n - 1|)$ .

So suppose that  $M(\gamma)$  is toroidal. We then have a punctured torus  $F_\gamma$  in  $M$  with boundary slope  $\gamma$ , such that the capped-off torus  $\widehat{F}_\gamma$  in  $M(\gamma)$  is incompressible. Assume that  $n_\gamma$ , the number of boundary components of  $F_\gamma$ , is minimal over all such punctured tori. Similarly, assuming for the moment only that  $M(\beta)$  is toroidal, we have a punctured torus  $F_\beta$  in  $M$  with boundary slope  $\beta$  and  $n_\beta$  boundary components. Triples  $(M; F_\beta, F_\gamma)$  of this kind with  $\Delta(\beta, \gamma) \geq 4$  are classified in [Go1] (in the case  $\Delta(\beta, \gamma) \geq 6$ ) and [GW] (in the case  $\Delta(\beta, \gamma) = 4$  or  $5$ ). In particular, it is shown in [GW] that if  $M$  is a hyperbolic knot manifold with a once-punctured torus slope  $\beta$  and a toroidal slope  $\gamma$  with  $\Delta(\beta, \gamma) = 4$ , then  $(M; \gamma, \beta) \cong (Wh(\delta); -4, 0)$  for some slope  $\delta$  on the other boundary component of  $Wh$ . This proves part (3)(a) of the theorem.

The only examples with  $n_\beta = 1$  and  $\Delta(\beta, \gamma) \geq 5$  are  $M = Wh(-5/2)$ , with  $\Delta(\beta, \gamma) = 7$  [Go1], and  $M = M_5$  or  $M_{10}$  in [GW], with  $\Delta(\beta, \gamma) = 5$ . In fact the only examples with  $\Delta(\beta, \gamma) = 5$  where  $M(\beta)$  (say) contains a non-separating torus are  $M_5, M_{10}$  and  $M_{11}$  (see [GW, Lemma 23.1]). Now in [MP] three examples of hyperbolic knot manifolds are given, each with a pair of toroidal fillings at distance 5, one of which contains a non-separating torus: these

are  $Wh(-7/2)$ ,  $Wh(-4/3)$  and  $N(-5, 5)$ , described in Tables A.3, A.4 and A.9, respectively. By comparing the description in these tables of the second toroidal filling at distance 5 with that given in [GW, Lemma 22.2], we see that  $Wh(-7/2) = M_{10}$ ,  $N(-5, 5) = M_{11}$ , and (hence)  $Wh(-4/3) = M_5$ . It is well-known that  $Wh(\delta)$  contains a once-punctured essential torus of slope 0. The determination of the slopes  $\gamma, \beta$  as listed in parts (3)(b) and (3)(c) has been done by Martelli and Petronio. See [MP, Tables A.2 and A.3].  $\diamond$

*Proof of Theorem 1.5.* Let  $K \subset S^3$  be a hyperbolic knot of genus one with exterior  $M_K$  and suppose  $p/q$  is an exceptional filling slope on  $\partial M_K$  where  $q \geq 1$ .

Hyperbolic genus one knots in the 3-sphere do not admit reducible surgery slopes [BZ1], so an exceptional surgery slope is either toroidal or irreducible, atoroidal, small Seifert. If  $K$  is fibred, it is necessarily the figure eight knot, and the theorem holds in this case. Assume that  $K$  is not a fibred knot. Then

- (a)  $M_K(0)$  is not fibred [Ga]
- (b)  $K$  admits no  $L$ -space surgery [Ni]
- (c)  $K$  is not a Eudave-Muñoz knot [E-M]

A genus one Seifert surface for  $K$  completes to an essential torus in  $M_K(0)$  [Ga]. Suppose that  $M_K(0)$  is Seifert fibred. As its first homology group is infinite cyclic, its base orbifold must have underlying space  $S^2$  and  $M_K(0)$  must have non-zero Euler number. Thus it admits a non-separating, horizontal surface, which implies  $M_K(0)$  fibres over the circle, contrary to (a). Thus  $M_K(0)$  is not Seifert fibred, so assertion (1) of the theorem holds.

By (b),  $K$  has no finite surgery slopes. Thus if  $M_K(p/q)$  is small Seifert with base orbifold  $S^2(a, b, c)$ , then  $p \neq 0$  and  $(a, b, c)$  is either a Euclidean or hyperbolic triple, so  $|p| \leq 3$  by Theorem 1.3. Consideration of  $H_1(S^2(a, b, c))$  shows that  $(a, b, c)$  is a hyperbolic triple. Hence assertion (2) of the theorem holds.

Theorem 1.3 combines with (b) and assertion (2) to show that if  $M_K(p/q)$  is small Seifert then  $0 < |p| \leq 3$ . Thus assertion (3) of the theorem holds.

Since  $K$  is not a Eudave-Muñoz knot, each toroidal slope of  $K$  is integral. It follows from [Go1] and [Te1] that no genus one knot in the 3-sphere admits a toroidal filling slope of distance 5 or more from the longitude. Such knots with toroidal slopes of distance 4 are determined in [GW, Theorem 24.4]. In particular, all such knots are twist knots and the non-longitudinal slope is  $\pm 4$ . This proves assertion (4).  $\diamond$

## REFERENCES

- [Ba] K. Baker, *Once-punctured tori and knots in lens spaces*, Comm. Anal. Geom. **19** (2011), 347–399.
- [BiMe] J. Birman and Wm. Menasco, *Studying links via closed braids III*, Pac. J. Math. **161** (1993), 25–113.
- [BCSZ1] S. Boyer, M. Culler, P. Shalen, and X. Zhang, *Characteristic submanifold theory and Dehn filling*, Trans. Amer. Math. Soc. **357** (2005), 2389–2444.

- [BCSZ2] \_\_\_\_\_, *Characteristic subvarieties, character varieties, and Dehn fillings*, *Geometry & Topology* **12** (2008) 233–297.
- [BGZ1] S. Boyer, C. McA. Gordon and X. Zhang, *Dehn fillings of large hyperbolic 3-manifolds*, *J. Diff. Geom.* **58** (2001), 263–308.
- [BGZ2] \_\_\_\_\_, *Characteristic submanifold theory and toroidal Dehn filling*, to appear in *Adv. Math.*
- [BGZ3] \_\_\_\_\_, *Dehn fillings of knot manifolds containing essential twice-punctured tori*, in preparation.
- [BZ1] S. Boyer and X. Zhang, *Reducing Dehn filling and toroidal Dehn filling*, *Topology Appl.* **68** (1996) 285–303.
- [BZ2] \_\_\_\_\_, *On Culler-Shalen seminorms and Dehn fillings*, *Ann. Math.* **148** (1998), 737–801.
- [CGLS] M. Culler, C. M. Gordon, J. Luecke and P. Shalen, *Dehn surgery on knots*, *Ann. of Math.* **125** (1987) 237–300.
- [CJR] M. Culler, W. Jaco and H. Rubinstein, *Incompressible surfaces in once-punctured torus bundles*, *Proc. Lond. Math. Soc.* **45** (1982) 385–419.
- [Du] Wm. Dunbar, *Geometric orbifolds*, *Rev. Mat.* **1** (1988) 67–99.
- [E-M] M. Eudave-Muñoz, *Non-hyperbolic manifolds obtained by Dehn surgery on hyperbolic knots*, *Geometric topology* (Athens, GA, 1993), 35–61, *AMS/IP Stud. Adv. Math.*, 2.1, Amer. Math. Soc., Providence, RI, 1997.
- [FH] W. Floyd and A. Hatcher, *Incompressible surfaces in punctured-torus bundles*, *Top. Appl.* **13** (1982), 263–282.
- [FKP] D. Futer, E. Kalfagianni, and J. Purcell, *Cusp areas of Farey manifolds and applications to knot theory*, to appear in *Int. Math. Res. Not.*
- [Ga] D. Gabai, *Foliations and the topology of 3-manifolds II*, *J. Diff. Geom.* **26** (1987), 461–478.
- [Go1] C. McA. Gordon, *Boundary slopes of punctured tori in 3-manifolds*, *Trans. Amer. Math. Soc.* **350** (1998) 1713–1790.
- [Go2] \_\_\_\_\_, *Dehn filling: a survey*, in *Knot Theory*, Banach Center Publications 42, Institute of Mathematics, Polish Academy of Sciences, Warsaw, 1998, 129–144.
- [GLi] C. McA. Gordon and R. A. Litherland, *Incompressible surfaces in branched coverings, The Smith conjecture*, *Pure Appl. Math.*, 112, Academic Press (1984) 139–152.
- [GL] C. McA. Gordon and J. Luecke, *Toroidal and boundary-reducing Dehn Fillings*, *Topology Appl.* **93** (1999) 77–90.
- [GW] C. McA. Gordon and Y.-Q. Wu, *Toroidal Dehn fillings on hyperbolic 3-manifolds*, *Mem. Amer. Math. Soc.* **194** (2008), no.909.
- [GW2] \_\_\_\_\_, *Toroidal and annular Dehn fillings*, *Proc. London Math. Soc.* **78** (1999) 662–700.
- [HR] C. Hodgson and H. Rubinstein, *Involutions and isotopies of lens spaces*, in *Knot Theory and Manifolds*, ed. D. Rolfsen, *Lecture Notes in Mathematics* **1144**, Springer-Verlag, 1983, 60–96.
- [KT] P. K. Kim and J. L. Tollefson, *Splitting the PL involutions of nonprime 3-manifolds*, *Michigan Math. J.* **27** (1980) 259–274.
- [LM] M. Lackenby and R. Meyerhoff, *The maximal number of exceptional Dehn surgeries*, preprint (2008), arXiv:0808.1176.
- [L1] S. Lee, *Dehn fillings yielding Klein bottles*, *Int. Math. Res. Not.* 2006, Art. ID 24253, 34pp.
- [L2] \_\_\_\_\_, *Klein bottle and toroidal Dehn fillings at distance 5*, *Pacific J. Math.* **247** (2010), 407–434.
- [L3] \_\_\_\_\_, *Lens spaces and toroidal Dehn fillings*, *Math. Z.* **267** (2011), 781–802.
- [LT] S. Lee and M. Teragaito, *Boundary structure of hyperbolic 3-manifolds admitting annular and toroidal fillings at large distance*, *Canad. J. Math.* **60** (2008) 164–188.
- [MP] B. Martelli and C. Petronio, *Dehn filling of the “magic” 3-manifold*, *Comm. Anal. Geom.* **14** (2006), 969–1026.
- [MSch] Y. Moriah and J. Schultens, *Irreducible Heegaard splittings of Seifert fibred spaces are either vertical or horizontal*, *Topology* **37** (1998) 1089–1112.
- [Ni] Y. Ni, *Knot Floer homology detects fibred knots*, *Invent. Math.* **170** (2007), no. 3, 577–608.
- [Oe] U. Oertel, *Closed incompressible surfaces in complements of star links*, *Pacific J. Math.* **111** (1984), 209–230.
- [Oh] S. Oh, *Reducible and toroidal manifolds obtained by Dehn filling*, *Top. Appl.* **75** (1997), 93–104.
- [Sh] H. Short, *Some closed incompressible surfaces in knot complements which survive surgery*, in *Low dimensional topology*, ed. Roger Fenn, *London Math. Soc. Lecture Notes* 95, Cambridge University Press, 1985, 179–194.
- [Te1] M. Teragaito, *Distance between toroidal surgeries on hyperbolic knots in the 3-sphere*, *Trans. Amer. Math. Soc.* **358** (2006), 1051–1075.
- [Te2] \_\_\_\_\_, *Creating Klein bottles by surgery on knots*, *J. Knot Theory Ramifications* **10** (2001) 781–794.
- [Wu1] Y.-Q. Wu, *Incompressibility of surfaces in surgered 3-manifolds*, *Topology*, **31** (1992) 271–279.
- [Wu2] \_\_\_\_\_, *Dehn fillings producing reducible manifolds and toroidal manifolds*, *Topology* **37** (1998), 95–108.
- [YM] S-T Yau and W. Meeks, *The equivariant loop theorem for three-dimensional manifolds and a review of the existence theorem for minimal surfaces*, in *The Smith conjecture*, *Pure Appl. Math.*, 112, Academic Press (1984) 153–163.

DÉPARTEMENT DE MATHÉMATIQUES, UNIVERSITÉ DU QUÉBEC À MONTRÉAL, 201 AVENUE DU PRÉSIDENT-KENNEDY, MONTRÉAL, QC H2X 3Y7.

*E-mail address:* `boyer.steven@uqam.ca`

*URL:* <http://www.cirget.uqam.ca/boyer/boyer.html>

DEPARTMENT OF MATHEMATICS, UNIVERSITY OF TEXAS AT AUSTIN, 1 UNIVERSITY STATION, AUSTIN, TX 78712, USA.

*E-mail address:* `gordon@math.utexas.edu`

*URL:* <http://www.ma.utexas.edu/text/webpages/gordon.html>

DEPARTMENT OF MATHEMATICS, UNIVERSITY AT BUFFALO, BUFFALO, NY, 14214-3093, USA.

*E-mail address:* `xinzhang@buffalo.edu`

*URL:* <http://www.math.buffalo.edu/~xinzhang>