

Arnold diffusion in a pendulum lattice.

Vadim Kaloshin*, Mark Levi† Marya Saprykina

June 8, 2018

The main model studied in this paper is a lattice of nearest neighbors coupled pendula. For certain localized coupling we prove existence of energy transfer and estimate its speed.

1 The description of the motion.

We consider a system of pendula with a nearest neighbors coupling:

$$\ddot{x}_i + \sin x_i = -\varepsilon \frac{\partial}{\partial x_i} \beta(x_{i-1}, x_i, x_{i+1}, \varepsilon), \quad i \in \mathbb{Z}, \quad (1)$$

where the interaction potential β is localized and will be defined later. This system can be written in the Hamiltonian form with $\mathbf{x} = \{x_i\}_{i \in \mathbb{Z}}$, $\mathbf{y} = \{y_i\}_{i \in \mathbb{Z}}$, x_i and $y_i \in \mathbb{R}$, with the the Hamiltonian

$$\begin{aligned} H_\varepsilon(\mathbf{x}, \mathbf{y}) &= \sum_{i \in \mathbb{Z}} \frac{y_i^2}{2} + (-\cos x_i - 1) + \varepsilon \beta(x_{i-1}, x_i, x_{i+1}, \varepsilon) = \\ &= \sum_{i \in \mathbb{Z}} \frac{y_i^2}{2} + V(x_i) + \varepsilon \beta(x_{i-1}, x_i, x_{i+1}, \varepsilon), \end{aligned} \quad (2)$$

where $V(x) = -\cos x - 1$ is the pendulum potential.

The system is near-integrable for small ε , and most (in the sense of measure) of the systems's phase space is taken up by invariant KAM tori. In particular, for most initial data the energy of each pendulum will stay close to its initial value for all time. Nevertheless, we will show that this is not so for some motions, where the energy can slowly “seep” from one pendulum to another. We will in fact prove that for an arbitrarily small ε and for any sequence of integers $\sigma = (\dots, \sigma_{-1}, \sigma_0, \sigma_1, \dots)$ such that $\sigma_0 = 0, |\sigma_j - \sigma_{j+1}| = 1$ for all $j \in \mathbb{Z}$ there exists a sequence of times $(\dots, t_{-1}, t_0, t_1, \dots)$ (depending on ε) such that at time t_k the σ_j -th pendulum has most of the system's energy. In particular, one can make the energy wander along the chain of the pendula in any prescribed fashion, advancing to the right any number of steps, retreating to the left any number of steps, and so on.

*partially supported by NSF grant DMS-0701271

†Partially supported by NSF grant DMS-0605878

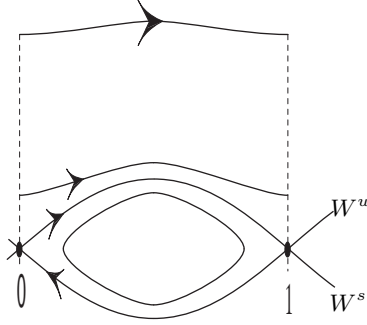

Figure 1: The “running” and the near-heteroclinic motion are the building blocks of the dynamics.

From now on we fix the energy of the system to be 1^1 . Below we shall concentrate on the case of periodic collection of 4 pendula, i.e. of the index $i \pmod{4}$. The proof in the general periodic case $i \in \mathbb{Z}/p\mathbb{Z}$ is quite similar and necessary remarks are made along the proof.

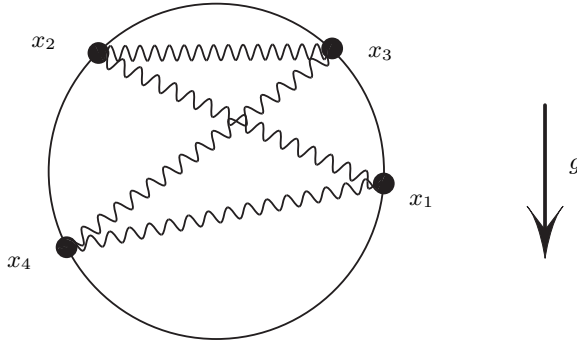

Figure 2: A mechanical interpretation of (3) with $\beta = \sin(x_{j-1} - 2x_j + x_{j+1})$.

We note as a side remark that the space discretization of the sin-Gordon equation $u_{tt} - u_{ss} = \sin u$ results in a system of pendula with elastic coupling [BWE, KP, WES]:

$$\beta(x_{j-1}, x_j, x_{j+1}) = a(x_{j-1} + x_{j+1} - 2x_j); \quad (3)$$

this corresponds to an elastic torsional coupling between the neighbors. In particular, as the angle $x_{j+1} - x_j \rightarrow \infty$ we have $\beta \rightarrow \infty$. By contrast, the coupling we consider in this paper can be interpreted as coming from a spring connecting points on a circle with angular coordinates x_j , as shown in Figure 2.

The coupling in our system is, however, localized, as described next. The class of coupling functions β for which our results hold is defined as follows: Let $\eta : \mathbb{R}_+ \rightarrow \mathbb{R}$ be a C^∞ bump function: $\eta(x) > 0$ for $|x| < 1$ and $\eta(x) = 0$ for $|x| \geq 1$. Exact form

¹Energy 0 corresponds to all pendula upside down and at rest. Indeed, the maximum of the potential energy $V(x) = -\cos x - 1$ of an individual pendulum is 0 and is achieved at $x = \pi$, an upside-down position.

of η is not important, and in particular, no monotonicity properties are assumed; in particular, η is allowed to have many local maxima and minima, as long as the above conditions hold. We now define

$$\beta(x, \varepsilon) = \varepsilon^r \sum_{n \in \mathbb{Z}^3} \eta \left(\frac{|x - 2\pi n|}{\varepsilon} \right), \quad x = (x_1, x_2, x_3) \in \mathbb{R}^3, \quad (4)$$

and fix $r \geq 3$ from now on. This is a C^∞ -smooth 2π -periodic function in each x_j , $j = 1, 2, 3$, or, equivalently, a function on $2\pi\mathbb{R}^3/\mathbb{Z}^3$. Note that the C^r -norm of $\varepsilon\beta(\cdot, \varepsilon)$ tends to zero as $\varepsilon \rightarrow 0$, while the norms of order $r + 2$ and higher are unbounded for $\varepsilon \rightarrow 0$. We fix any finite $r \geq 3$ from now on.

We will sometimes refer to connected components of support of β as *lenses*: in fact, they act by defocusing geodesics in the Jacobi metric, as explained later, as in [KL1].

According to the main theorem, stated next, the energy

$$E_j := \frac{\dot{x}_j^2}{2} + V(x_j) \quad (5)$$

at the j th site can pass from one site to another in an arbitrarily prescribed sequence of steps, as illustrated in Figure 3. Here is a more precise statement.

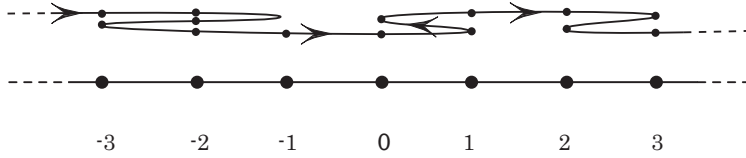

Figure 3: Any path in the graph \mathbb{Z} can be shadowed by a solution of (1).

Theorem 1. *Let us fix the total energy² $E = 1$ in the system (1) with β satisfying (4). There exists $\varepsilon_0 > 0$ such that for any $0 < \varepsilon < \varepsilon_0$ and for any path $\dots\sigma_{-1}\sigma_0\sigma_1\dots$ in the graph \mathbb{Z} there exists a solution of (1) and a sequence of times $\dots t_{-1}t_0t_1\dots$ such that the energies (5) of individual pendula satisfy*

$$|E_{\sigma_j}(t_j) - 1| < C\sqrt{\varepsilon}, \quad \text{and} \quad |E_\sigma(t_j)| < C\sqrt{\varepsilon} \quad \text{for} \quad \sigma \neq \sigma_j,$$

where C is independent of ε . The times t_j can be chosen so that

$$0 < t_{j+1} - t_j \leq C\varepsilon^{-4r-8}. \quad (6)$$

This theorem shows that, although the system (1) is near-integrable, so that for most (in the sense of Liouville measure) solutions the action stays close to its initial value for all time, there exist nevertheless solutions for which the action changes by $O(1)$ no matter how small ε is. In other words, the system exhibits Arnold diffusion. According to (6) the rate of this diffusion is polynomial. The bound in (6) is not

²In fact, any value in excess of the potential energy of an upside-down equilibrium works.

sharp, but it can be improved by a more careful tracing of the estimates in our example. In the general case, polynomial upper bounds for speed of diffusion for finitely-differentiable systems have been obtained in [Bu].

The first example of Arnold diffusion was outlined in the well known paper of Arnold [A]. Bessi [Bs] (see also [BB]) proved diffusion in Arnold’s example by a variational method, by considering the gradient flow of the Lagrangian action functional. John Mather [Ma] used a somewhat similar approach to construct accelerating orbits for time periodic mechanical systems on a 2-torus (see also [BT, GT, DLS, Ka]). References to the recent progress on Arnold diffusion goes beyond the scope of this paper and can be found in [KL2]. In the present paper we use a slightly different version of this approach, based on using the Maupertuis’ principle. We construct the “diffusing” solutions as geodesics in a Jacobi metric, so that all these solutions have a fixed prescribed energy. These geodesics are constructed by concatenating geodesic segments which follow a prescribed itinerary. The construction is fairly similar to [KL1, KL2].

Anderson localization is an important example of energy (non)transfer (see [LTW] for a survey), still not very well understood. The role of Arnold diffusion for destruction of Anderson localization is discussed in [Ba]. Probably the most popularized lattice model is the one introduced by Fermi-Pasta-Ulam in their seminal paper [FPU]. Although most small amplitude solutions in the FPU model do not exhibit energy transfer (see e.g. [HK]), proving the existence of solutions with energy transfer is an interesting open problem. Other physically significant lattice models are discussed in [FSW].

Understanding of the transfer of energy for Hamiltonian PDEs is one of emerging directions of research (see [Bo]; a recent progress for the cubic defocusing nonlinear Schrödinger equation has been made in [I]).

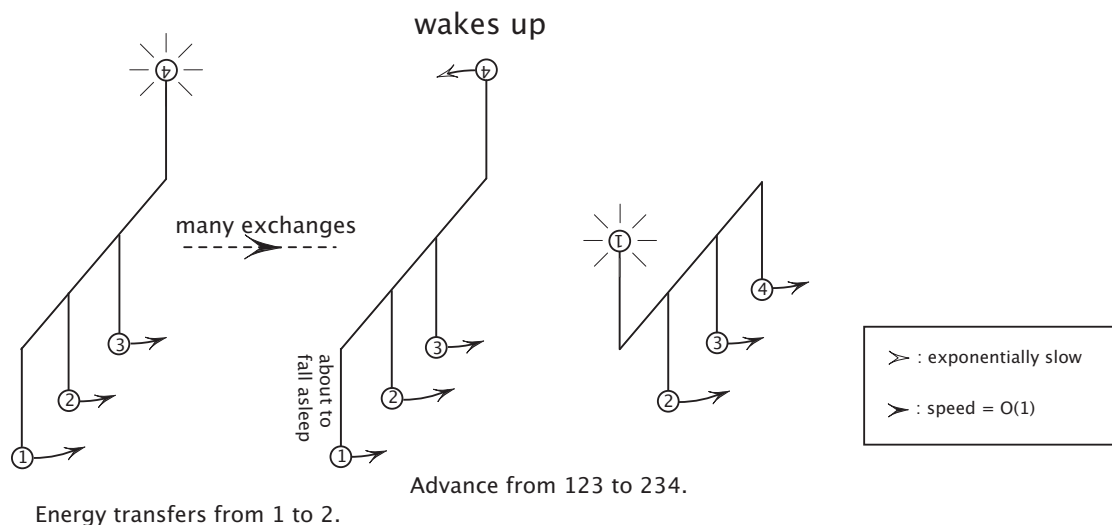

Figure 4: One full step in the propagation of the “kink”.

1.1 A heuristic description of propagation

In this section we give a purely heuristic picture of the physical motions showing Arnold diffusion. As mentioned earlier, we consider the periodic case $x_{i+4} = x_i$ as a representative example.

Stage 1: transfer of energy. In this stage only three pendula: **1**, **2** and **3** governed by (1) with $k = 1, 2$ and 3 are “active”, while **4** “sleeps” upside-down (see Figure 4, left). The stage consists of many substages illustrated by Figures 5, left. In each of these substages a small amount of energy is transferred from **1** to **2**. This transfer is somewhat similar to the one described in [KL1] for a metric on the 3-torus. Finally, in the last substage, **1** is left with just enough energy to climb upside down and to fall asleep there, while **2** rotates with speed $O(1)$, as shown in the middle of Figure 4. The same motion, viewed in the configuration space \mathbb{R}^4 , is shown in Figure 5.

The motion just described is similar to that in a slightly simpler example described in [KL1, KL2].

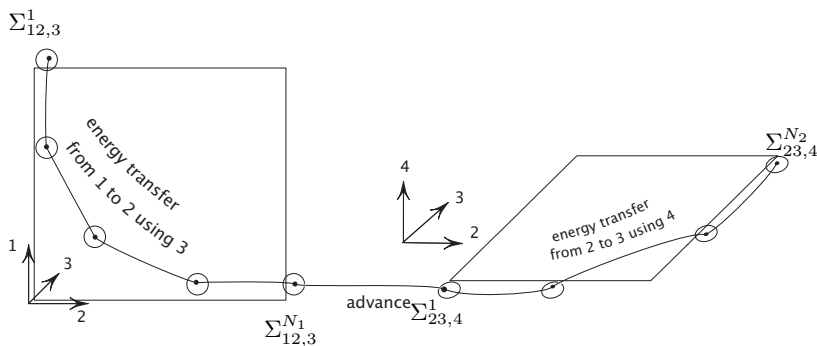

Figure 5: Energy transfer and sections in the configuration space \mathbb{R}^4 .

Stage 2: advance. This stage is sketched in Figure 4, right and Figure 5, middle. At $t = t_1$ three neighbors, say **1**, **2**, and **3**, are in the bottom position. The middle pendulum **2** is running: $\dot{x}_2 = O(1)$, while its two neighbors **1** and **3** have near-heteroclinic speeds close to the heteroclinic speeds $\sqrt{-2V(x_i)}$, $i = 1, 3$ resp., at $t = t_1$. The remaining pendulum **4** is up (see Figure 4 middle). As the time goes on, while **2** is spinning with speed $O(1)$, **1** rises to the top equilibrium, where it will sleep until further notice, while the sleeper **4** “wakes up”, i.e. falls from its perch, turning by π by the exact moment when **2** finishes a large integer number of full spins. By that moment, x_3 makes a “gentle” turn by 2π , returning to the bottom position. In short, the accomplishment of this stage is the falling asleep of **1** and the awakening of **4**. This is illustrated in Figure 4, right. We will call this stage the “advance” because of its similarity with the advancing caterpillar: a rear foot **1** is placed on the ground, while the front foot **4** is lifted, ready to move.

The ending moment of the second stage is the beginning moment of the first stage described above modulo the shift of the index by 1. We have, in other words, a “traveling wave” – a (very) discrete analog of the kink in the sine–Gordon equation. However, in contrast to the standard traveling kink, ours can change the direction of its propagation arbitrarily, according to a prescribed itinerary.

2 The proof of Theorem 1.

The full complexity of the problem is already seen in the case of 4 pendula, and we limit our consideration to that case. Now we restate the theorem in geometrical terms. The following is motivated by the heuristic outline of the energy transfer between the pendula: as mentioned before (see Figures 4 and 5), we want the energy to pass from one pendulum (e.g. **1**) to another (e.g. **2**) in small increments over many steps, after which the pendula should change roles: the “giver” **1** “falls asleep”, while a “sleeper” (e.g. **4**) “wakes up” thus enabling the “taker” **2** to become the next “giver”. This is reflected in the following geometrical construction. First, we construct an itinerary (section 2.1) for the desired orbit. Then we reformulate the problem of existence such an orbit as a variational problem. Finally, we prove the existence of a solution to this problem in section 2.2. In the latter section we use two lemmas 3 and 2 stated (and proved) in sections 5 and 4 respectively.

2.1 Constructing an itinerary

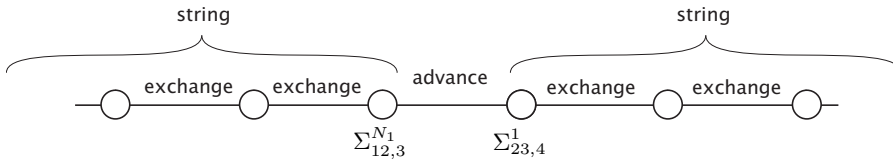

Figure 6: An itinerary.

To prove Theorem 1, given a path in the graph (see Figure 3) we must produce an orbit that shadows this path. We describe the construction in the case of *monotone energy transfer* (i.e., to the right neighbor): $\sigma_{j+1} = \sigma_j + 1 = j + 1$ for all $j \in \mathbb{Z}$. Extension to the case of general path $(\dots \sigma_0 \sigma_1 \sigma_2 \dots)$ poses no new difficulties. We thus consider an infinite sequence of codimension one sections in \mathbb{R}^4 , grouped into finite strings, Figures 5 and 6:

$$\dots \underbrace{(\Sigma_{12,3}^1 \Sigma_{12,3}^2 \dots \Sigma_{12,3}^{N_1})}_{1 \rightarrow 2} \underbrace{(\Sigma_{23,4}^1, \Sigma_{23,4}^2, \dots, \Sigma_{23,4}^{N_2})}_{2 \rightarrow 3} \dots, \quad (7)$$

where the sections and their spacings are defined according to the following rules:

1. Section $\Sigma_{12,3}^1$, for example, is seen in Figure 4, left. The subscripts 12 indicate that 1 and 2 exchange energy, and 3 is the “facilitator”:

$$\Sigma_{12,3}^1 := \{x_3 = 0, \quad x_1^2 + x_2^2 \leq \varepsilon, \quad |x_4 - \pi| \leq \sqrt{\varepsilon}\}. \quad (8)$$

2. All sections within each string in (7) are integer translates of each other. For example, in the first string $1 \rightarrow 2$:

$$\Sigma_{12,3}^{k+1} = \Sigma_{12,3}^k + 2\pi(m_{12,3}^k, n_{12,3}^k, 1, 0) =: \Sigma_{12,3}^k + \vec{n}_{12,3}^k \quad k = 1, \dots, N_1$$

To define the second string, we replace $i \mapsto i + 1 \pmod{4}$ in (8), setting

$$\Sigma_{23,4} := \{x_4 = 0, \quad x_2^2 + x_3^2 \leq \varepsilon, \quad |x_1 - \pi| \leq \sqrt{\varepsilon}\}. \quad (9)$$

We then define $\Sigma_{23,4}^1$ as a translate of $\Sigma_{23,4}$ by integer multiples of 2π in each coordinate. Each section in the second string is an integer translate of the previous section by

$$\vec{n}_{23,4}^k := 2\pi(0, m_{23,4}^k, n_{23,4}^k, 1)$$

3. The neighboring strings are related via

$$Center(\Sigma_{23,4}^1) = Center(\Sigma_{12,3}^{N_1}) + 2\pi\left(\frac{1}{2}, m_{23,4}^0, 1, \frac{1}{2}\right) = Center(\Sigma_{12,3}^{N_1}) + \vec{n}_{23,4}^0.$$

4. All translates are far apart: each

$$|\vec{n}_{\dots}^k| \geq \varepsilon^{-2r-4} \quad (10)$$

5. The turns are gradual in the sense that the unit vectors $e^k_{\dots} = \vec{n}_{\dots}^k / |\vec{n}_{\dots}^k|$ satisfy

$$|e_{\dots}^{k+1} - e_{\dots}^k| \leq \varepsilon^{2r+4}, \quad |e_{\dots+1}^1 - e_{\dots}^{N_j}| \leq \varepsilon^{2r+4}. \quad (11)$$

As mentioned above, treating a general itinerary poses no difficulties.

2.2 A variational problem and its solution

We note that the energy one solution of (1) are the geodesics in the Jacobi metric³

$$d\rho(\mathbf{x}) = \sqrt{1 - \sum_{i=1}^4 (V(x_i) - \varepsilon\beta(x_{i-1}, x_i, x_{i+1}, \varepsilon))} \, ds, \quad (12)$$

where $\mathbf{x} = (x_1, x_2, x_3, x_4)$, $V(x) = -\cos x - 1 \leq 0$, ds is the Euclidean metric and indices of x_i 's are taken mod 4.

With the sections having been defined in items 1–5 above, we now list *the main steps of the proof of Theorem 1*, and fill in the details in the following sections.

1. *Defining geodesic segments.* Let Σ_0, Σ_1 be two consecutive sections in the chain of sections (7) and let $p_i \in \Sigma_i$, $i = 0, 1$. Centers of these sections differ by $2\pi\vec{n}$ with \vec{n} being either $(m, n, 1, 0) \in \mathbb{Z}^4$, or $(\frac{1}{2}, s, 1, \frac{1}{2})$ with $s \in \mathbb{Z}$ and satisfying (10). According to Lemma 3 from section 5, there exists a connecting geodesic $\gamma(p_0, p_1)$ of (12) which depends smoothly on its ends p_0, p_1 . At this stage the integer parameters either m and n or s are still free.

³Up to the factor $\sqrt{2}$, the square root is the speed of the energy one solution in the configuration space.

2. *Constructing a long shadowing geodesic.* Consider a finite segment of $N + 2$ sections from the sequence (7). To simplify notation, we denote these sections by Σ_i , $0 \leq i \leq N + 1$ (N here is arbitrarily large). We also choose arbitrary points $p_i \in \Sigma_i$. Later we will treat p_0, p_{N+1} as fixed and p_1, \dots, p_N as variable.

According to the preceding item there exists a broken geodesic $\gamma(p_0, \dots, p_N)$, a concatenation of energy one orbits $\gamma(p_i, p_{i+1})$ of (1).

The length (in the Jacobi metric) of this broken geodesic

$$L(p_1, \dots, p_N) = L(p_0, p_1) + \dots + L(p_{N-1}, p_N). \quad (13)$$

is a function of break points p_j ; we omit p_0 and p_{N+1} from the left-hand side since they will be considered as fixed.

We will show that L has a **minimum on the interior of its domain** $\Sigma_1 \times \dots \times \Sigma_N$. Such an interior minimum corresponds to a true geodesic. We will thus establish the existence of a geodesic with a prescribed itinerary.

3. *The key step: existence of an interior minimum for (13).* Let us consider two consecutive terms from the sum (13):

$$S(p) = L(p_{j-1}, p) + L(p, p_{j+1}), \quad p \in \Sigma_j \quad (14)$$

where $p_{j\pm 1} \in \Sigma_{j\pm 1}$ are fixed and $p \in \Sigma_j$ is variable. Without loss of generality we take $\Sigma_j = \Sigma_{12,3}^1$, given by (8)⁴. To prove the existence of an interior minimum of (13) it suffices to show that the minimum of $S(p)$ is achieved in the interior of Σ_j . To that end we first alter β in the Jacobi metric (12) by setting $\beta = 0$ *only* in the cylinder $x_1^2 + x_2^2 + x_3^2 < \varepsilon^2$ which passes through the center of Σ_j (we do not alter β anywhere else). Before restoring β to its original form, we study the associated length

$$S^0(p) = L^0(p_0, p) + L^0(p, p_2), \quad p \in \Sigma_j \equiv \Sigma. \quad (15)$$

Once the properties of S^0 are established (see (16) and (17) below), we will show that restoring β to its original form creates a minimum for S in the interior of Σ . Without the loss of generality, we take $\Sigma = \Sigma_{12,3}^1$ as in (8), so that $S^0 = S^0(x_1, x_2, x_4)$.

We will first show that $S_0 = S^0(x_1, x_2, x_4)$ is “nearly constant” in the first two variables and has a minimum near the “equator” $x_4 = \pi$:

$$|S^0(x_1, x_2, x_4) - S^0(0, 0, x_4)| \leq 2c\varepsilon^{r+2.5}, \quad (16)$$

$$S^0(x_1, x_2, \pi \pm \sqrt{\varepsilon}) > S^0(x_1, x_2, \pi) + \frac{\varepsilon}{2} \quad (17)$$

for any $(x_1, x_2, \pi) \in \Sigma$.

⁴For the future reference, we note that the triple may or may not be entirely in one string in the sequence (7) of sections.

Proof of (16) and (17). By Lemma 1 from [KL1] we have, with $p = (x_1, x_2, x_3, x_4)$:

$$\frac{\partial L^0(p_-, p)}{\partial x_i} = \dot{x}_i^-, \quad \frac{\partial L^0(p, p_+)}{\partial x_i} = -\dot{x}_i^+,$$

where $\mathbf{x}^-(t) = (x_1^-, x_2^-, x_3^-, x_4^-)$ is the energy one solution with the modified β , connecting p_{j-1} to p , and where the differentiation is taken at the moment the solution passes through p . This solution exists by Lemma 3 below. We use a similar notation x^+ for the energy one solution connecting p with p_{j+1} . We thus conclude that

$$\frac{\partial S^0}{\partial x_i}(p) = \dot{x}_i^- - \dot{x}_i^+, \quad i = 1, 2, 4; \quad (18)$$

this identity⁵ will allow us to analyze S^0 . Now, due to the fact that the perturbation β near p is removed the pendula are decoupled and the velocity is explicitly given in terms of energy distribution (5)

$$|\dot{x}_i| = \sqrt{2(E_i - V(x_i))},$$

where E_i is the energy of the i th pendulum near p . The estimate of (18) is now reduced to studying the difference of velocities. We have to consider two cases: in one, $\Sigma_{j-1}, \Sigma, \Sigma_{j+1}$ belong to the same string in (7) (the case of “energy transfer”), and in the other, they do not (“the advance”).

Case 1 – energy transfer. In this case all sections lie in the same string in (7) – say, in $1 \rightarrow 2$. The displacements $2\pi\vec{n}_-$ and $2\pi\vec{n}_+$ are then of the form $2\pi(m_\pm, n_\pm, 1, 0)$ with integer m_\pm and n_\pm . Assuming the integers to be positive (we can always assume them to be of the same sign), we have

$$\dot{x}_i^- > 0, \quad \dot{x}_i^+ > 0, \quad i = 1, 2, 3, \quad (19)$$

at the moment when Σ is crossed.

The fact that the signs are the same for x^+ and x^- is of key importance because it provides a near-cancellation in (18) for $i = 1, 2, 3$. Thus, we have

$$\frac{\partial S^0}{\partial x_i} = \sqrt{2(E_i^- - V(x_i))} - \sqrt{2(E_i^+ - V(x_i))}, \quad i = 1, 2. \quad (20)$$

Note that if $0 \leq A \leq B$ then $\sqrt{B} - \sqrt{A} \leq \sqrt{B - A}$; this, used in (20), gives

$$\left| \frac{\partial S^0}{\partial x_i} \right| \leq \sqrt{2|E_i^+ - E_i^-|}, \quad i = 1, 2. \quad (21)$$

Now according to Lemma 2 and the assumptions (10) and (11) we have

$$|E_i^+ - E_i^-| \leq c\varepsilon^{2k+4}, \quad i = 1, 2, 3, 4 \quad (22)$$

and by (21)

$$|\partial_{x_i} S^0| \leq c\varepsilon^{k+2}, \quad i = 1, 2. \quad (23)$$

⁵we do not differentiate by x_3 since we only need to define S and S^0 on $\Sigma \subset \{x_3 = 0\}$.

Combining this with (21), we obtain (16), showing that S^0 is “flat” in the first two variables.

To estimate $\partial S^0/\partial x_4$ note that (x_4^-, \dot{x}_4^-) and (x_4^+, \dot{x}_4^+) stay at the $\sqrt{\varepsilon}$ -neighborhood of the saddle $(x_4, \dot{x}_4) = (\pi, 0)$. Since the distance between sections is large (10) and the phase velocity is bounded (by the choice of fixed energy), the duration of each stage is at least ε^{-2k-4} . This implies that (x_4^-, \dot{x}_4^-) is at worst $O(\exp(-\varepsilon^{-1}))$ -close to the unstable manifold

$$y = U(x) = (x - \pi) + O((x - \pi)^2),$$

while (x_4^+, \dot{x}_4^+) is at worst $O(\exp(-\varepsilon^{-1}))$ -close to the stable manifold $y = -U(x)$ of the same saddle – all this at the moment when the solution crosses Σ . That is,

$$\dot{x}_4^- = U(x) + O(\exp(\varepsilon^{-1})) \quad (24)$$

and

$$\dot{x}_4^+ = -U(x) + O(\exp(\varepsilon^{-1})) \quad (25)$$

so that

$$\frac{\partial S^0}{\partial x_4} = 2U(x) = 2(x_4 - \pi) + O((x_4 - \pi)^2) + O(\exp(\varepsilon^{-1})). \quad (26)$$

Integration by x_4 gives (17).

Case 2 — advance. In this case not all sections lie in the same string in (7); without the loss of generality, assume that Σ_{j-1}, Σ are the last two in the string $1 \rightarrow 2$, while Σ_{j+1} is the first in the following string $2 \rightarrow 3$. In this case the displacement vectors are of the form $\vec{n}_- = (m, n, 1, 0)$, $\vec{n}_+ = (\frac{1}{2}, s, 1, \frac{1}{2})$. In this case we still have (19), and following (20) and (21) we obtain (16). Since the sign of \dot{x}_4 is unknown, we treat it separately, observing, as before, that (24) and (25) hold. This implies (26) and thus (17).

This completes the proof of (16) and (17) in both cases.

Proof of the interior minimum for S . Using the properties of S^0 and the positivity of β we now show that S has a minimum inside Σ . We do so for Case 1; the remaining case is treated almost verbatim.

The boundary $\partial\Sigma = \partial_v\Sigma \cup \partial_h\Sigma$ consists of the “vertical” and the “horizontal” parts (after possible reindexing of the coordinates):

$$\begin{aligned} \partial_v\Sigma &= \{x_1^2 + x_2^2 = \varepsilon, |x_4 - \pi| \leq \sqrt{\varepsilon}\}, \\ \partial_h\Sigma &= \{x_1^2 + x_2^2 \leq \varepsilon, |x_4 - \pi| = \sqrt{\varepsilon}\}. \end{aligned} \quad (27)$$

A key observation we will use shortly is this:

$$S(p) = S^0(p) \quad \text{for all } p \in \partial_v\Sigma. \quad (28)$$

Proof: We wish to show that the energy one solution $\gamma(p_{j-1}, p)$ with p lying on $\{x_1^2 + x_2^2 = \varepsilon, x_3 = 0\}$ does not intersect the lens $x_1^2 + x_2^2 + x_3^2 \leq \varepsilon^2$. To that end assume the contrary: the solution travels from one set to the other, taking some time $t = t^* > 0$. Since the distance between the sets is $\geq \frac{1}{2}\sqrt{\varepsilon}$, while the speed

is ≤ 2 , the time of travel is $t^* > \frac{1}{4}\sqrt{\varepsilon}$. But $\dot{x}_3 \geq 1$ for as long as $|x_3| \leq \sqrt{\varepsilon}$. Thus during time t^* , x_3 changes by the amount $\Delta x_3 > \frac{1}{4}\sqrt{\varepsilon}$, which means that the solution lies outside the lens $x_1^2 + x_2^2 + x_3^2 \leq \varepsilon$, in contradiction with the definition of t^* . This proves (28).

We now show that the restriction of S to each horizontal disk in Σ :

$$D_h := \{x_1^2 + x_2^2 \leq \varepsilon, x_4 = \pi + h\}, \quad |h| \leq \sqrt{\varepsilon}$$

has a minimum in the interior of D_h . To that end, we first note a crucial fact that β decreases S (as compared to S^0) near the center $C_h = (0, 0, \pi + h)$ of each D_h . Note that by the definition (4) the infimum of $\beta(\cdot, \varepsilon)$ taken over the set $x_1^2 + x_2^2 + x_3^2 \leq \varepsilon^2/2$ is bounded from below by $b\varepsilon^r$ for some $b > 0$ independent of ε . Therefore, comparing the geodesic length in the original Jacobi metric with the truncated one, we obtain

$$S(C_h) \leq S^0(C_h) - \varepsilon \inf \beta(\cdot, \varepsilon) \leq S^0(C) - b\varepsilon^{r+1}. \quad (29)$$

See [KL1] (proof of Lemma 4) for more details on this argument.

On the other hand, by (16) we have, for any $p \in \partial D_h$, $|h| \leq \sqrt{\varepsilon}$:

$$S^0(C_h) \leq S^0(p) + c\varepsilon^{r+2.5}.$$

Combining this with (29) and (28) we obtain

$$S(C_h) \leq S(p) + c\varepsilon^{r+2.5} - b\varepsilon^{r+1} < S(p), \quad \forall p \in \partial D_h.$$

We showed that the minimum of S cannot be achieved on $\partial_v \Sigma$, and it remains to show that it cannot be achieved on $\partial_h \Sigma$ either. Estimate (17) shows that S^0 has a pronounced minimum near the equator $x_4 = \pi$. By the same estimate as we used for (29), we have a two-sided result: $|S^0(x) - S(x)| \leq \varepsilon^{r+2}$, which together with (17) gives

$$S(x_1, x_2, \pi \pm \sqrt{\varepsilon}) > S(x_1, x_2, \pi).$$

This proves that the minimum is achieved *inside* Σ .

To complete the proof of the main theorem it remains to observe that the existence of the the internal minimum for S implies the existence of the internal minimum for $L(p_1, \dots, p_N)$, as well as the existence of an internal minimum for an infinitely long sequence (7). The details can be found in [L].

3 The pendulum Lemma.

In this section we state and prove an auxiliary lemma which is used in the proofs of the main two lemmas in the following two sections.

Lemma 1. *For any $|\alpha| \leq 1$, $|\beta - \pi| < 1$, and $T > 0$ there exists a unique solution $x(t; T, \alpha, \beta)$ of $\ddot{x} + \sin x = 0$, satisfying $x(0) = \alpha$, $x(T) = \beta$ with the additional property*

$$\alpha \leq x(t) \leq \max\{\beta, \pi\} \quad \text{for } 0 \leq t \leq T. \quad (30)$$

This solution depends smoothly on T , α and β , and, moreover, as T increases from 0 to ∞ , the energy $E = \dot{x}^2/2 + (-1 - \cos x)$ decreases monotonically from ∞ to 0.

A similar statement holds if either

$$|\alpha + \pi| \leq 1, \quad |\beta| \leq 1,$$

$$|\alpha| \leq 1, \quad |\beta - 2\pi| \leq 1,$$

or

$$\beta - \alpha \geq 2\pi,$$

with the solution confined to the interval $[-1 - \pi, 1]$ in the first case, $[-1, 2\pi + 1]$ in the second case and $[\alpha, \beta]$ in the last case. In particular, in the last case $\beta - \alpha$ can be arbitrarily large.

Corollary 1. Consider the uncoupled system⁶

$$\ddot{x}_i + \sin x_i = 0, \quad i = 1, \dots, 4. \quad (31)$$

For any $q, p \in \mathbb{R}^4$ such that $\alpha = q_i, \beta = p_i$ satisfies conditions of Lemma 1 for each $i = 1, \dots, 4$, then for any $T > 0$ there is a unique solution $X(t, T, q, p)$ of the system (31) satisfying $X(0) = q$ and $X(T) = p$. Moreover, there is a unique $T > 0$ such that energy of this solution is one.

We first prove the Corollary.

Proof of the Corollary. Lemma 1 applies to each of the n equations in (31), by the assumptions of the Corollary. That is, for any $T > 0$ there exists a unique solution $x_i(t) = x_i(t; T, q_i, p_i)$ of $\ddot{x}_i + \sin x_i = 0$ with the desired boundary conditions. Now as T increases from 0 to ∞ , the energy $E_i(T)$ of each solution decreases monotonically from ∞ to 0. There is therefore a unique $T = T^*$ with $\sum_{i=1}^n E_i(T^*) = 1$. In addition, T^* is a smooth function of q, p , by an application of the implicit function theorem. Q.E.D.

Proof of the Lemma. We concentrate on the first case; the remaining ones are essentially the same. We write the equation of the pendulum as the system

$$\begin{cases} \dot{x} = y \\ \dot{y} = -\sin x. \end{cases} \quad (32)$$

We are seeking a solution starting on the line $x = \alpha$ and ending at $t = T$ on the line $x = \beta$. The condition $\beta \geq \pi - 1$ imposes a lower bound on the initial velocity. This leads us to consider the ray OM of initial data on the line $x = \alpha$, see Figure 7, where O is the point whose solution crosses the x -axis at $x = \pi - 1$.

Consider now the ray OM carried by the flow of (32) for time T , where T is fixed arbitrarily. Consider the set I_T on the ray OM whose points enter the strip $S = \{\pi - 1 \leq x \leq \pi + 1\}$ at some time $t \leq T$ and do not leave it before $t = T$. We claim: *For any $T > 0$, the set I_T is an interval, and its image $\varphi^T(I_T)$ under the*

⁶Since we chose to concentrate on $n = 4$ pendula, we formulate the lemma for this case, although the proof carries over verbatim for an arbitrary n .

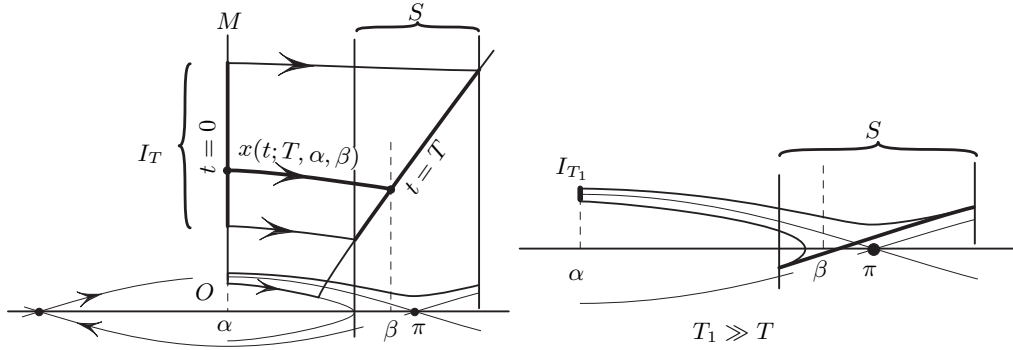

Figure 7: The slope of the image of the vertical interval is positive.

flow at $t = T$ is a curve with a positive slope, connecting the two boundaries of the strip S , Figure 7. This claim implies the statement of the Lemma.

If T is small, i.e. if the solutions are fast and thus lie above the separatrix, the result is obvious. However, for T large some solutions starting on I_T “turn around”, as in Figure 7 (B), and the proof requires a little care.

Let $z_0 = (\alpha, y_0) \in I_T$; this, we recall, means that (i) $z^T \equiv \varphi^T z_0 \in S$, and (ii) once z^t enters S it does not leave S before $t = T$. Consider the linearization of (32):

$$\begin{cases} \dot{\xi} = \eta \\ \dot{\eta} = -(\cos x) \xi, \end{cases} \quad (33)$$

where x is the solution of (32) with the chosen initial condition. Note that the solution $\zeta = (\xi, \eta)$ of (33) with $\zeta(0) = (0, \eta_0)$, $\eta_0 > 0$ is a tangent vector to the image curve $\varphi^T(OM)$ at the point $\varphi^T z_0$. It suffices, therefore, to prove that $\zeta(T)$ lies in the first quadrant. This equation is changing type from elliptic to hyperbolic, and thus is it not *a priori* clear that the solution may not execute an unwanted rotation, violating positivity of the slope η/ξ . The idea is to show that during the “dangerous” elliptic stage while $x(t) < \pi - 1$, η/ξ remains positive.

To that end, let $\tau \in (0, T]$ be the time of entrance of the solution $\varphi^t z_0 = (x(t), y(t))$ into S , so that

$$x(t) \in [\alpha, \pi - 1] \text{ for } t \in [0, \tau]$$

and

$$x(t) \in [\pi - 1, \pi + 1] \text{ for } t \in [\tau, T]$$

We will first show that $\eta/\xi > 0$ at $t = \tau$.

The key idea is to observe that the vector $z = (x, \dot{x})$ rotates clockwise faster than the vector $\zeta = (\xi, \eta)$; this will be shown shortly. Since the slope of z is positive at $t = \tau$, the same will then be true of $\zeta(\tau)$ as desired. We claim:

$$\frac{d}{dt} \left(\frac{y}{x} \right) < \frac{d}{dt} \left(\frac{\eta}{\xi} \right) < 0, \text{ whenever } \frac{y}{x} = \frac{\eta}{\xi}. \quad (34)$$

To prove (34) we carry out the differentiations and use the equality of the slopes to reduce the inequality to an equivalent one:

$$\frac{\dot{y}x - y\dot{x}}{x^2} < \frac{\dot{\eta}\xi - \eta\dot{\xi}}{\xi^2} < 0,$$

or, using (32) and (33):

$$\frac{-x \sin x - y^2}{x^2} < \frac{-\cos x \xi^2 - \eta^2}{\xi^2} < 0.$$

Using the equality of slopes, this reduces to

$$\frac{\sin x}{x} > \cos x,$$

which holds true thanks to $x \in (0, \pi)$. We conclude: since $y(\tau)/x(\tau) \geq 0$, and $\eta(\tau)/\xi(\tau) > 0$.

We show that the slope of ζ remains positive for the remaining time $[\tau, T]$. During this time $|x - \pi| \leq 1$ and thus $\cos x < 0$. Hence the linearized vector field (33) crosses **into** the first quadrant, and since $\zeta(\tau)$ lies in that quadrant, it is still there at $t = T$.

The monotonicity of $E = E(T)$ also follows from (i) the positivity of the slope of the image curve $\varphi^T(I_T)$, and (ii) from the fact that the curve moves “to the right” as T increases. Indeed, if we increase T , the point of intersection of $\varphi^T(I_T)$ with $x = \beta$ moves down, to the curve with the same $x = \beta$ but with the smaller y , i.e. with the smaller value of $E = y^2 + (-1 - \cos \beta)$. Furthermore, if T is small, the velocity must be large: $\beta - \alpha = x(T) - x(0) \leq (\max y) T$, so that $\max y \geq \frac{\beta - \alpha}{T} \rightarrow \infty$ as $T \rightarrow 0$. On the other hand, if T is sufficiently large, then all solutions starting on I_T must pass arbitrarily close to the saddle $(\pi, 0)$ and thus must have energy close to that of the saddle, i.e. to $E_{\text{saddle}} = -(-1 - \cos \pi) = 0$.

The proof of Lemma 1 is complete.

4 The Hyperbolic Lemma.

By Corollary 1 of Lemma 1, given any points $q, q' \in \mathbb{R}^4$ with their coordinates x_i and x'_i lying $[-1, 1] \bmod 2\pi$ or in $[\pi - 1, \pi + 1] \bmod 2\pi$, there exists a solution $X(t; q, q', T)$ of (31) with $\varepsilon = 0$ which travels from q to q' in time T . By the same corollary, there exists a unique $T(q, q')$ for which the total energy of the solution $X(t; q, q', T(q, q'))$ is one:

$$\sum_{i=1}^4 E_i = 1, \quad \text{where} \quad E_i = \frac{\dot{X}_i^2}{2} + V(X_i). \quad (35)$$

We thus associate with the energy one solution (of (1) with $\varepsilon = 0$) connecting q and q' , the energy vector

$$\mathbf{E}(q, q') \stackrel{\text{def}}{=} (E_1, E_2, E_3, E_4);$$

according to the Lemma 1, this vector is uniquely determined by the endpoints q, q' .

Lemma 2. *If two pairs of points: q_1, q'_1 and q_2, q'_2 in \mathbb{R}^4 satisfy the conditions⁷*

$$|q'_k - q_k| \geq \varepsilon^{-2r-5}, \quad k = 1, 2, \quad (36)$$

and

$$|e_2 - e_1| < \varepsilon^{2r+5}, \quad \text{where } e_k = \frac{q'_k - q_k}{|q'_k - q_k|}, \quad k = 1, 2, \quad (37)$$

then the energy vector \mathbf{E} of the connecting solution of (1) with $\beta = 0$ satisfies

$$|\mathbf{E}(q_2, q'_2) - \mathbf{E}(q_1, q'_1)| < \varepsilon^{2r+5}. \quad (38)$$

Moreover, there exists a constant C such that for all q, q' with $|q' - q| \geq 1$ we have

$$\left| \frac{d}{dq} \dot{X}(0; q, q', T(q, q')) \right| < C; \quad (39)$$

here the notation $\frac{d}{dq}$ is used to emphasize that the q -dependence enters \dot{X} in two places – one through the boundary condition, and the other through $T(q, q')$.

Proof. Statement (38) follows from the proof of Lemma 1; the main difficulty is in proving (39)⁸. To prove (39), we expand its left hand side:

$$\frac{d}{dq} \dot{X}(0; q, q', T(q, q')) = \partial_q \dot{X}(0; q, q', T) + \partial_T \dot{X}(0; q, q', T) \cdot \partial_q T(q, q'), \quad (40)$$

where $T = T(q, q')$ is to be substituted after the differentiations on the right-hand side. We will now estimate each of the summands on the right-hand side separately.

Estimate of $\partial_q \dot{X}(0; q, q', T)$. The proof of Lemma 1 shows that each component X_i of X depends on the boundary conditions x_i, x'_i and T only⁹, but not on x_j, x'_j with $j \neq i$. This implies that the matrix $\partial_q \dot{X}(0; q, q', T)$ is diagonal, with the diagonal entries $\partial X_i(x_i, x'_i, T)/\partial x_i$. But this derivative is simply the slope of the image of the line $x = x'$ under the map φ^{-T} , where φ^t is the phase flow of the pendulum equation. The argument of Lemma 1 shows that, because of the shear in the phase velocity field, this slope is always bounded once T exceeds a fixed constant. It remains to prove the upper bound for the last summand in (40).

Estimate of $\partial_T \dot{X}(0; q, q', T) \cdot \partial_q T(q, q')$. We will first show that this term is expressible via the first factor alone, thus reducing the number of estimates needed. Note that $\partial_T \dot{X} \cdot \partial_q T$ is a square matrix, the product of the row matrix $\partial_T \dot{X}$ with the column gradient matrix $\partial_q T(q, q')$. To prove the lemma, it remains to show that each entry

$$|\partial_T \dot{X}_i(0; x_i, x'_i, T) \cdot \partial_{x_j} T(q, q')| < C, \quad (41)$$

for $|q' - q| \geq 1$.

⁷Since we chose to concentrate on $n = 4$ pendula, we formulate the lemma for this case, although the proof carries over verbatim for an arbitrary n .

⁸this estimate can be strengthened: C can be replaced by $C/|q' - q|$, but we do not need this in our proof.

⁹We recall the notation $q = (x_1, x_2, x_3, x_4)$.

Some identities. Let

$$K_i = \left(\int_{x_i}^{x'_i} \frac{dx}{(2(E_i - V(x)))^{3/2}} \right)^{-1}, \quad \text{and} \quad K = \sum_{s=1}^4 K_s. \quad (42)$$

We will show that

$$\partial_{x_i} T(q, q') = K^{-1} \partial_T \dot{X}_i(0; x_i, x'_i, T), \quad (43)$$

thus reducing (41) to an equivalent inequality

$$|K^{-1} \partial_T \dot{X}_i(0; x_i, x'_i, T) \partial_T \dot{X}_j(0; x_j, x'_j, T)| < C. \quad (44)$$

Heuristically, one expects that $|\partial_T \dot{X}_i(0; x_i, x'_i, T)| \leq cT^{-1}$. Indeed, $\dot{X}_i(0; x_i, x'_i, T)$ is the y -coordinate of the intersection, in the (X, \dot{X}) -plane of the line $\{X = x_i\}$ and the curve $\varphi^{-T}\{X = x'_i\}$, where φ^t is the phase flow of the pendulum equation. Now because of the shear in the phase flow, one expects the line $\ell_T = \varphi^{-T}\{X = x'_i\}$ to form angle at most cT^{-1} with the trajectories. Thus the point $\ell_T \cap \{X = x_i\}$ is expected to move with speed $\leq cT^{-1}$, suggesting that indeed $|\partial_T \dot{X}_i(0; x_i, x'_i, T)| \leq cT^{-1}$. We carry out a precise proof by an alternative, purely analytical method (which ultimately reduces to the same estimates). Namely, we will use the following identity:

$$\partial_T \dot{X}_i(0; x_i, x'_i, T) = -\frac{K_i}{\sqrt{2(E_i - V(x_i))}}, \quad (45)$$

which, together with (43), is proven in a separate section below.

Estimate of K^{-1} . Since $\sum_{i=1}^4 E_i = 1$, we have $\frac{1}{4} \leq E_i \leq 1$ for some i , and thus for some C we have

$$K_i^{-1} = \int_{x_i}^{x'_i} \frac{dx}{(2(E_i - V(x)))^{3/2}} \leq C \int_{x_i}^{x'_i} \frac{dx}{\sqrt{2(E_i - V(x))}} = CT,$$

so that

$$K^{-1} = \left(\sum_{j=1}^4 K_j \right)^{-1} < K_i^{-1} \leq CT. \quad (46)$$

Estimate of $\partial_T \dot{X}_i(0; x_i, x'_i, T)$. We consider two separate cases: (i) $|x'_i - x_i| < 2\pi$ and (ii) $|x'_i - x_i| \geq 2\pi$.

1. **In case (i)**, an estimate of (45) is easier done geometrically, as follows. Consider the graph $y = U_T(x)$ of the time T -preimage of the line $x = x'$ in the phase plane of the pendulum. Let $y = U(x)$ be the graph of the unstable manifold of the saddle $(\pi, 0)$; by a standard hyperbolic argument, the flow takes the line exponentially close to the unstable manifold: $|U_T(x) - U(x)| < e^{-cT}$, for $|x| \leq \pi$, and, moreover, the motion of the line becomes exponentially slow:

$$\left| \frac{d}{dT} U_T(x) \right| < e^{-cT}, \quad \text{for } |x| \leq \pi; \quad (47)$$

here T is greater than a fixed positive constant because of the assumption $|q' - q| \geq 1$. But $U_T(x_i) = \dot{X}_i(0; q, q', T)$ and (47) gives

$$|\partial_T \dot{X}_i(0; q, q', T)| \leq e^{-cT}, \quad \text{for } |x'_i - x_i| < 2\pi. \quad (48)$$

This completes the proof of (44), and thus of the Lemma, in case (i).

2. **In case (ii)** we have $x'_i - x_i = 2\pi n_i + r$, $0 \leq r < 2\pi$ with integer $n_i \neq 0$. We will use (45) to prove (44), to which end we need an upper bound on K_i . From (42) we have

$$K_i^{-1} \geq n_i \int_{-\pi}^{\pi} \frac{dx}{(E_i - V(x))^{3/2}} \geq n_i \int_{-\pi}^{\pi} \frac{dx}{(E_i + x^2/2)^{3/2}} = c \frac{n_i}{E_i}, \quad (49)$$

where $c = 2\pi/\sqrt{1 + \pi^2/2}$. Now the number of revolutions $n_i \geq T/\mathcal{T}_{E_i}$ where $\mathcal{T}(E_i)$ is the time of one full revolution: as

$$\mathcal{T}_{E_i} = \int_{-\pi}^{\pi} \frac{dx}{\sqrt{2(E_i + 2\sin^2 x/2)}} \leq \sqrt{2} \int_0^{\pi} \frac{dx}{\sqrt{E_i + x^2/\pi^2}} = \sqrt{2}\pi(\ln(1 + \sqrt{1 + E_i}) - \ln E_i).$$

Substituting this into (49) we get

$$K_i \leq c \frac{E_i}{n_i} \leq c \frac{E_i \mathcal{T}_{E_i}}{T} \leq c_1 \frac{E_i(\ln(1 + \sqrt{1 + E_i}) - \ln E_i)}{T}.$$

Finally, we substitute this estimate into (45):

$$|\partial_T \dot{X}_i(0; x_i, x'_i, T)| \leq c \frac{E_i(\ln(1 + \sqrt{1 + E_i}) - \ln E_i)}{T \sqrt{E_i}} \leq \frac{c}{T}$$

Together with (46) this proves (44). The proof of the lemma is thus complete.

Proof of the identities (43) and (45). The energy of the solution $X(t; x_i, x'_i, T)$ is a smooth function of Let x_i, x'_i, T ; we denote this energy by $E(x_i, x'_i, T)$, so that

$$\dot{X}(0; x_i, x'_i, T) = \sqrt{2(E(x_i, x'_i, T) - V(x_i))}.$$

Differentiating by T we get

$$\frac{\partial}{\partial T} \dot{X}(0; x_i, x'_i, T) = \frac{\partial E(x_i, x'_i, T)/\partial T}{\sqrt{2(E(x_i, x'_i, T) - V(x_i))}} \quad (50)$$

To estimate the numerator, we differentiate the identity

$$T = \int_{x_i}^{x'_i} \frac{dx}{\sqrt{2(E(x_i, x'_i, T) - V(x))}} \quad (51)$$

with respect to T and solve for $\partial E/\partial T$, obtaining

$$\partial E(x_i, x'_i, T)/\partial T = - \left(\int_{x_i}^{x'_i} \frac{dx}{(2(E(x_i, x'_i, T) - V(x)))^{3/2}} \right)^{-1} \stackrel{def}{=} -K_i^{-1}. \quad (52)$$

Substituting this into (50) proves (45). To prove the remaining identity (43), we recall that $T(x, x')$ is the time which gives energy one to the solution:

$$\sum_{k=1}^4 E(x_k, x'_k, T(x_k, x'_k)) = 1. \quad (53)$$

Differentiating this by x_i gives

$$\left. \frac{\partial E(x_i, x'_i, T)}{\partial x_i} \right|_{T=T(x, x')} + \frac{\partial T(x, x')}{\partial x_i} \sum_{k=1}^4 \frac{\partial E(x_k, x'_k, T)}{\partial T} = 0. \quad (54)$$

The above sum, according to (52), can be replaced by $-\sum_{k=1}^4 K_k \stackrel{def}{=} -K$; solving for $\partial T/\partial x_i$ gives

$$\frac{\partial T(x, x')}{\partial x_i} = K^{-1} \left. \frac{\partial E(x_i, x'_i, T)}{\partial x_i} \right|_{T=T(x, x')}. \quad (55)$$

To estimate the last derivative, we differentiate the identity¹⁰ (51) by x_i :

$$0 = -\frac{1}{\sqrt{2(E_i - V(x_i))}} - \underbrace{\int_{x_i}^{x'_i} \frac{dx}{(2(E_i - V(x)))^{3/2}}}_{K_i^{-1}} \frac{\partial E(x_i, x'_i, T)}{\partial x_i},$$

or

$$\frac{\partial E(x_i, x'_i, T)}{\partial x_i} = -\frac{K_i}{\sqrt{2(E_i - V(x_i))}}.$$

Substituting this into (55) results in the proof of (43):

$$\frac{\partial T(x, x')}{\partial x_i} = -K^{-1} \frac{K_i}{\sqrt{2(E_i - V(x_i))}} \stackrel{(45)}{=} K^{-1} \partial_T \dot{X}_i(0; x_i, x'_i, T).$$

The proof of the two identities is now complete.

5 The connection Lemma.

The following lemma is the building block in the construction of shadowing geodesics.

Lemma 3 (Existence of geodesic segments). ¹¹ *There exists $\varepsilon_0 > 0$ such that for all $0 < \varepsilon < \varepsilon_0$ the following holds. Consider any two sections, which we denote by Σ_0 and Σ_1 , in the itinerary (7), such that the vector $2\pi\vec{n}$ connecting the centers of Σ_0 , Σ_1 satisfies $|\vec{n}| > \frac{1}{\varepsilon}$. This vector is of the form $2\pi(m, n, 1, 0)$ or $2\pi(\frac{1}{2}, s, 1, \frac{1}{2})$ (with integer m, n or s), modulo possible translation in the index. Then for all $p_0 \in \Sigma_0$, $p_1 \in \Sigma_1$ there exists a geodesic $\gamma(p_0, p_1)$ in the Jacobi metric (12) connecting p_0 with p_1 , and depending smoothly on p_0 and p_1 .*

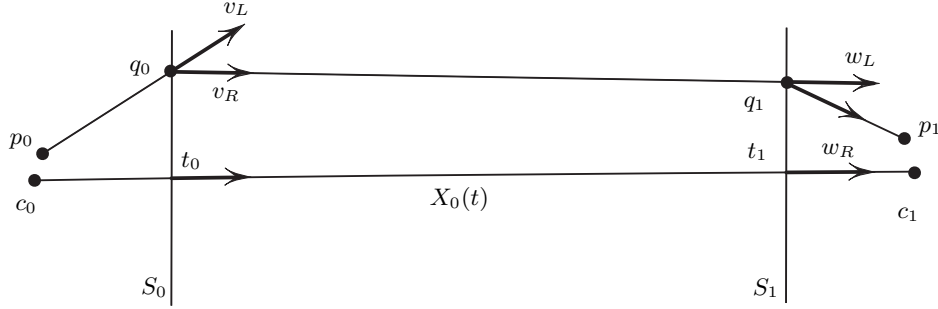

Figure 8: Towards proof of Lemma 3.

Proof.

1. We first define a section S_0 shown in Figure 8, as follows. By Lemma 1 there exists a (unique) solution $X_0(t)$ of (31) of energy one, connecting $c_0 = \text{Center}(\Sigma_0)$ with $c_1 = \text{Center}(\Sigma_1)$. We now define the section S_0 as the codimension one disk in \mathbb{R}^4 at the distance $\varepsilon^{\frac{1}{3}}$ from c_0 and perpendicular to the initial direction $e_0 = \dot{X}_0(0)/|\dot{X}_0(0)|$:

$$S_0 = \{q : (q - c_0) \cdot e_0 = \varepsilon^{\frac{1}{3}}, \quad |q - (c_0 + \varepsilon^{\frac{1}{3}}e_0)| < \varepsilon^{\frac{1}{3}}\},$$

where \cdot denotes the usual dot product. Analogously, we define the section S_1 near c_1 , except for reversing the sign of e_1 .

2. For any pair of points $q_0 \in S_0$, $q_1 \in S_1$ we consider three geodesic segments (in the metric (12)): $\gamma(p_0, q_0)$, $\gamma(q_0, q_1)$ and $\gamma(q_1, p_1)$, along with the velocities of the associated solutions of (1) v_L , v_R , w_L , w_R as shown in Figure 8¹². The lemma will be proven once we show that there exists a pair q_0 , q_1 , smoothly dependent on p_0 , p_1 , for which

$$v_L = v_R \quad \text{and} \quad w_L = w_R. \quad (56)$$

To that end we first list the properties of each of the three geodesic segments.

3. Since radius of Σ_0 is $\varepsilon^{1/2}$, we have $|q_0 - p_0| = O(\varepsilon^{\frac{1}{3}})$, which is small compared to the injectivity radius of the metric (12). By standard arguments from differential geometry (using the smoothness of solutions of the ODEs and the implicit function theorem) we conclude that

$$v_L = v_0 \frac{q_0 - p_0}{|q_0 - p_0|} + r_{0L}(p_0, q_0, \varepsilon), \quad |r_{0L}|_{C^1} = O(\varepsilon^{\frac{1}{3}}); \quad (57)$$

here $v_0 = 3\sqrt{2}$ is the speed at c_0 (by the energy restriction (35 and the fact that the center of the lens corresponds to three pendula at the bottom, and

¹⁰Here and below $E_i = E(x_i, x'_i, T)$.

¹¹Since we chose to concentrate on $n = 4$ pendula, we formulate the lemma for this case, although the proof carries over verbatim for an arbitrary n .

¹²It should be noted that v_L , v_R , w_L , w_R all depend on q_0 , q_1 .

one at the top.). A similar estimate holds for the right end:

$$w_R = v_0 \frac{p_1 - q_1}{|p_1 - q_1|} + r_{1R}(q_1, p_1, \varepsilon), \quad |r_{1R}|_{C^1} = O(\varepsilon^{\frac{1}{3}}). \quad (58)$$

4. The intermediate segment $\gamma(q_0, q_1)$ avoids the lenses, and thus Lemma 2 applies; in particular, the C^1 -bound (39) holds, implying that

$$v_R = \dot{X}_0(t_0) + r_{0R}(q_0, q_1, \varepsilon), \quad |r_{0R}|_{C^1} < C\varepsilon^{\frac{1}{3}}. \quad (59)$$

and

$$w_L = \dot{X}_0(t_1) + r_{1L}(q_1, p_1, \varepsilon), \quad |r_{1L}|_{C^1} < C\varepsilon^{\frac{1}{3}}. \quad (60)$$

Here t_i ($i = 0, 1$) is the time when $X_0(t)$ intersects the section S_i .

5. We will prove the existence of the pair q_0, q_1 satisfying (56) by applying the implicit function theorem. To that end let \widehat{v} denote the orthogonal projection of $v \in \mathbb{R}^4$ onto $\mathbb{R}^3 \supset S$; we will also treat $q_0 \in \mathbb{R}^4$ as an element of $S \subset \mathbb{R}^3$, denoting it by $\widehat{q}_0 \in \mathbb{R}^3$. To prove (56) it suffices to prove that the projected equations

$$\widehat{v}_L = \widehat{v}_R \quad \text{and} \quad \widehat{w}_L = \widehat{w}_R \quad (61)$$

hold, since if (61) hold, then the remaining components orthogonal to S must match as well by the conservation of energy. Substituting the estimates (57), (58), (59) and (60) into (56) we obtain, after projecting onto $\mathbb{R}^3 \supset S$:

$$v_0 \frac{\widehat{q_0 - p_0}}{|\widehat{q_L - p_0}|} = \widehat{r}_0(p_0, \widehat{q}_0, \widehat{q}_1, \varepsilon), \quad v_0 \frac{\widehat{p_1 - q_1}}{|p_1 - q_1|} = \widehat{r}_1(\widehat{q}_0, \widehat{q}_1, p_1, \varepsilon) \quad (62)$$

as the equivalent matching conditions, with the C^1 -small remainders:

$$|\widehat{r}_i|_{C^1} < C\varepsilon^{\frac{1}{3}}.$$

In arriving at (62), we made use of the fact that $\widehat{\dot{X}_0(t_0)} = O(\varepsilon^{\frac{1}{3}})$, as follows from the choice of S_0 to be orthogonal to $\dot{X}_0(0)$ (so that $\widehat{\dot{X}_0(0)} = 0$) and the the fact that $t_0 = O(\varepsilon^{\frac{1}{3}})$.

6. To apply the implicit function theorem, instead of the variables \widehat{q}_i we introduce

$$Q_0 = v_0 \frac{\widehat{q_0 - p_0}}{|\widehat{q_L - p_0}|}, \quad Q_1 = v_0 \frac{\widehat{p_0 - q_1}}{|p_1 - q_1|},$$

$Q_i \in \mathbb{R}^3$. Expressing

$$\widehat{q}_0 = \widehat{p}_0 + v_0 |q_0 - p_0| Q_0, \quad \widehat{q}_1 = \widehat{p}_1 - v_0 |p_1 - q_1| Q_1$$

and substituting into (61), we obtain

$$Q_0 = R_0(p_0, Q_0, Q_1, \varepsilon), \quad Q_1 = R_1(Q_0, Q_1, p_1, \varepsilon).$$

Introducing $Q = (Q_0, Q_1) \in \mathbb{R}^6$ and $R = (R_0, R_1)$ we rewrite the matching condition (56) in the final form

$$Q = R(Q, p_0, p_1, \varepsilon),$$

where $|R|_{C^1} < C\varepsilon^{\frac{1}{3}}$. It is important to observe that R is defined (at least) on the entire ball $|Q| \leq \frac{1}{2}$, independent of ε . Thus for all sufficiently small ε there exists a unique solution Q depending differentiably on the parameters p_0, p_1 .

This completes the proof of Lemma 3.

References

- [A] Arnold, V. Instabilities in dynamical systems with several degrees of freedom, *Sov Math Dokl* 5: 581–585, 1964.
- [Ba] D. M. Basko, Weak chaos in the disordered nonlinear Schrödinger chain: destruction of Anderson localization by Arnold diffusion, arXiv:1005.5033v2
- [BB] M. Berti and Ph. Bolle, A functional analysis approach to Arnold diffusion. *Ann. Inst. H. Poincaré* 19, 4 (2002) 395–450.
- [Bs] Bessi, U. An approach to Arnold’s diffusion through the calculus of variations, *Nonlinear Anal.* **26 (6)** (1996), 1115–1135.
- [BWE] R. Boesch, C.R. Willis, and M. El-Batatouny, Spontaneous emission of radiation from a discrete sine-Gordon kink. *Phys. Rev. B* 40, 4 (1989), 2284–2296.
- [BT] Bolotin, S. Treschev, D. Unbounded growth of energy in non-autonomous Hamiltonian systems, *Nonlinearity* 12 (1999), no. 2, 365–388;
- [Bu] Bounemoura, A. Nekhoroshev estimates for finitely differentiable quasi-convex Hamiltonians, (2010), to appear in *Journal of Differential Equations*.
- [Bo] Bourgain, J. Problems in Hamiltonian PDE’s, *Gafa*, Special volume, (2000), 32–56.
- [DLS] Delshams, A. de la Llave, R. Seara, T. A geometric approach to the existence of orbits with unbounded energy in generic periodic perturbations by a potential of generic geodesic flows of T2. *Comm. Math. Phys.* 209 (2000), no. 2, 353–392.
- [FPU] Fermi E, Pasta J and Ulam S 1995 Studies of non linear problems Los Alamos Rpt. LA-1940
 Fermi E, Pasta J and Ulam S 1965 *Collected Papers of Enrico Fermi vol II* (Chicago: University of Chicago Press) 978–88
 Fermi E, Pasta J and Ulam S 2000 *Theory, Methods and Applications* 2nd edn (New York: Dekker)
- [FSW] Fröhlich, J. Spencer, T. Wayne, C. E. Localization in disordered, nonlinear dynamical systems. *J. Statist. Phys.* 42 (1986), no. 3-4, 247–274.

- [GT] Gelfreich, V. Turaev, D. Unbounded Energy Growth in Hamiltonian Systems with a Slowly Varying Parameter, *Commun. Math. Phys.* 283, 769794, 2008.
- [HK] Henrici, A. and Kappeler, T. 2008 Results on normal forms for FPU chains, *Commun. Math. Phys.* 278, 145–77.
- [I] Colliander, J.; Keel, M.; Staffilani, G.; Takaoka, H.; Tao, T. Transfer of energy to high frequencies in the cubic defocusing nonlinear Schrödinger equation. *Invent. Math.* 181 (2010), no. 1, 39–113.
- [KL1] Kaloshin, V., Levi, M. Geometry of Arnold diffusion, *SIAM Rev.* 50 (2008), no. 4, 702–720.
- [KL2] Kaloshin, V., Levi, M. An example of Arnold diffusion for near-integrable Hamiltonians, *Bull. Amer. Math. Soc. (N.S.)* 45 (2008), no. 3, 409–427.
- [Ka] Kaloshin, V. Geometric proofs of Mather’s connecting and accelerating theorems. *Topics in dynamics and ergodic theory*, 81 –106, London Math. Soc. Lecture Note Ser., 310, Cambridge Univ. Press, Cambridge, 2003.
- [KP] Kruskal M., Peyrard M. Kink dynamics in the highly discrete sine-Gordon system, *Physica* 14D (1984) 88-102;
- [LTW] Lagendijk, A. van Tiggelen, B. Wiersma, D. A. Fifty years of Anderson localization, *Phys. Today* 62, 2009, 24.
- [L] Levi, M., Shadowing property of geodesics in Hedlund’s metric. *Ergod. Th. & Dynam. Sys.* (1997), **17** , 187-203.
- [Ma] Mather, J. Variational construction of trajectories for time periodic Lagrangian systems on the two torus, preprint, 1996, unpublished;
- [WES] Willis, C. and El-Batanouny, M. and Stancioff, P. Sine-Gordon kinks on a discrete lattice. I. Hamiltonian formalism, *Phys. Rev. B*, 33, 3,1904–1911,1986. sine-Gordon reference