

# On cluster theory and quantum dilogarithm identities

Bernhard Keller

**Abstract.** These are expanded notes from three survey lectures given at the 14th International Conference on Representations of Algebras (ICRA XIV) held in Tokyo in August 2010. We first study identities between products of quantum dilogarithm series associated with Dynkin quivers following Reineke. We then examine similar identities for quivers with potential and link them to Fomin-Zelevinsky's theory of cluster algebras. Here we mainly follow ideas due to Bridgeland, Fock-Goncharov, Kontsevich-Soibelman and Nagao.

**2010 Mathematics Subject Classification.** Primary 16G20; Secondary 18E30, 17B37, 14N35.

**Keywords.** Quantum dilogarithm, cluster algebra, Hall algebra, triangulated category, Calabi-Yau category, Donaldson-Thomas invariant.

## Introduction

The links between the theory of cluster algebras [19, 20, 6, 22] and functional identities for the Rogers dilogarithm first became apparent through Fomin-Zelevinsky's proof [21] of Zamolodchikov's periodicity conjecture for  $Y$ -systems [65] (we refer to [53] and the references given there for the latest developments in periodicity in cluster theory and its applications to  $T$ -systems,  $Y$ -systems and dilogarithm identities). This link was exploited by Fock-Goncharov [18, 17], who emphasize the central rôle of the (quantum) dilogarithm both for commutative and for quantum cluster algebras and varieties. The quantum dilogarithm is also a key ingredient in Kontsevich-Soibelman's interpretation [51] of cluster transformations in the framework of Donaldson-Thomas theory. Indeed, Kontsevich-Soibelman show that, under suitable technical hypotheses, if two quivers with potential are related by a mutation [13], then their non commutative DT-invariants (*cf.* section 4.7) are linked by the composition of a monomial transformation with the adjoint action of a quantum dilogarithm. This composition coincides with Fock-Goncharov's cluster transformation for quantum  $Y$ -variables [17]. Therefore, Kontsevich-Soibelman's categorical setup for DT-theory contains a 'categorification' of the quantum  $Y$ -seed mutations and thus, modulo passage to the 'double torus' [17] or to 'principal coefficients' [22], of the quantum  $X$ -seed mutations. By extending this idea to compositions of mutations Nagao [52] has succeeded in deducing the main theorems on the (additive) categorification of cluster algebras [14] (*cf.* also [54]) from Joyce's [34, 36] and Joyce-Song's [37] results in DT-theory (*cf.* also [8]).

Our aim in the present survey is to give an introduction to this circle of ideas using quantum dilogarithm identities as a leitmotif. We start with the classical pentagon identity (section 1.1). Following Reineke [56] [57] and Kontsevich-Soibelman [51] [48] we link it to the study of stability functions for a Dynkin quiver of type  $A_2$  and present Reineke's generalization to arbitrary Dynkin quivers (Theorem 1.6). We sketch Reineke's beautiful and instructive proof in section 2. The result can be interpreted as stating that the refined DT-invariant of a Dynkin (and even an acyclic) quiver is well-defined. In this form, it is conjectured to generalize to an arbitrary quiver with a potential with complex coefficients (section 3.1). Evidence for this is given in Kontsevich-Soibelman's deep work [51, 50]. In section 4, we study the behaviour of the refined DT-invariant under mutations following section 8.4 of [51]. We begin by recalling the categorical setup: The category of finite-dimensional representations of the Jacobi-algebra of the given quiver with potential is embedded as the heart of the canonical t-structure in the 3-Calabi-Yau category  $\mathcal{D}_{fd}\Gamma$ , the full subcategory formed by the homologically finite-dimensional dg modules over the Ginzburg [29] dg algebra  $\Gamma$  associated with the given quiver with potential. In  $\mathcal{D}_{fd}\Gamma$ , the simple representations form a spherical collection (section 4.2) in the sense of [51]. Mutation is modeled by 'tilting' the heart (section 4.3), an idea going back to Bridgeland [10], cf. also [9] [11].

The comparison formula for the refined DT-invariants then becomes a simple consequence of the freedom in the choice of a stability function (section 4.4). The refined DT-invariant is defined to be rational (section 4.5) if its adjoint action is given by a rational transformation. This is the case in large classes of examples coming from representation theory, Lie theory and higher Teichmüller theory. In this case, the adjoint action is the 'non commutative DT-invariant' [63], whose behaviour under mutations is governed by Fock-Goncharov's mutation rule for quantum  $Y$ -variables (section 4.7). It is remarkable that this rule is involutive (section 4.8). In section 5, we study compositions of Fock-Goncharov mutations via functors

$$\text{FG} : \text{Ccl}^{op} \rightarrow \text{Sf} \quad \text{and} \quad \text{FG} : \text{Cl}t^{op} \rightarrow \text{Sf}$$

where  $\text{Sf}$  is the groupoid of skew fields,  $\text{Ccl}$  the groupoid of cluster collections in the ambient 3-Calabi-Yau category  $\mathcal{D}_{fd}\Gamma$  and  $\text{Cl}t$  the groupoid of cluster-tilting sequences in the cluster category  $\mathcal{C}_\Gamma$ . The main results of (quantum) cluster theory may be reformulated by saying that the image of a morphism  $\alpha : S \rightarrow S'$  of the groupoid of cluster collections, where  $S$  is the initial collection, only depends on the target  $S'$  (Theorem 5.2). We define an autoequivalence of  $\mathcal{D}_{fd}\Gamma$  respectively  $\mathcal{C}_\Gamma$  to be reachable if its effect on the initial cluster collection (respectively cluster tilting sequence) is given by a composition of mutations. We obtain a homomorphism  $F \mapsto \zeta(F)$  from the group of reachable autoequivalences of the ambient triangulated category to the group of automorphisms of the functor  $\text{FG}$  (sections 5.3 and 5.7). If the loop functor  $\Omega = \Sigma^{-1}$  of the ambient category is reachable, then the non commutative DT-invariant equals  $\zeta(\Sigma^{-1})$  (under the assumptions which ensure that it is well-defined). For example, in the context of the quivers with potential associated with pairs of Dynkin diagrams [39], the loop functor is reachable and of finite order, which shows that the non commutative DT-invariant is of

finite order in this case. This fact is of interest in string theory, *cf.* section 8 in [12], which builds on [26, 25, 24]. Following an idea of Nagao [52] we introduce the groupoid of nearby cluster collections in section 5.8 and show how it can be used to prove Theorem 5.2 (section 5.13) and to reconstruct the refined DT-invariant (Theorem 5.12). We conclude by presenting a purely combinatorial realization of the groupoid of nearby cluster collections: the tropical groupoid. In many cases, it allows for a purely combinatorial construction of the refined DT-invariant (section 5.14).

## Acknowledgment

I thank Sarah Scherotzke for providing me with her notes of the lectures and Tom Bridgeland, Changjian Fu, Christof Geiß, Pierre-Guy Plamondon and especially Mike Gorsky for their remarks on a preliminary version of this article. I am grateful to Kentaro Nagao, So Okada and Cumrun Vafa for stimulating (email) conversations and to Maxim Kontsevich for many inspiring lectures on the subject.

## 1. Quantum dilogarithm identities from Dynkin quivers, after Reineke

**1.1. The pentagon identity.** Let  $q^{1/2}$  be an indeterminate. We denote its square by  $q$ . The *quantum dilogarithm* is the (logarithm of the) series

$$\mathbb{E}(y) = 1 + \frac{q^{1/2}}{q-1} \cdot y + \cdots + \frac{q^{n^2/2} y^n}{(q^n - 1)(q^n - q) \cdots (q^n - q^{n-1})} + \cdots \quad (1.1)$$

considered as an element of the power series algebra  $\mathbb{Q}(q^{1/2})[[y]]$ . Notice that the denominator of its general coefficient is the polynomial which computes the order of the general linear group over a finite field with  $q$  elements. Let us define the *quantum exponential* by

$$\exp_q(y) = \sum_{n=0}^{\infty} \frac{y^n}{[n]!},$$

where  $[n]!$  is the polynomial which computes the number of complete flags in an  $n$ -dimensional vector space over a field with  $q$  elements. Then we have

$$\mathbb{E}(y) = \exp_q\left(\frac{q^{1/2}}{q-1} \cdot y\right), \quad (1.2)$$

which explains the choice of the notation  $\mathbb{E}$  (for the mysterious scaling factor, *cf.* Remark 3.3). The quantum dilogarithm has many remarkable properties (*cf. e.g.* [64] and the references given there), among which we single out the following.

**Theorem 1.2** (Schützenberger [61], Faddeev-Volkov [15], Faddeev-Kashaev [16]).  
 For two indeterminates  $y_1$  and  $y_2$  which  $q$ -commute in the sense that

$$y_1 y_2 = q y_2 y_1 ,$$

we have the equality

$$\mathbb{E}(y_1)\mathbb{E}(y_2) = \mathbb{E}(y_2)\mathbb{E}(q^{-1/2}y_1 y_2)\mathbb{E}(y_1). \quad (1.3)$$

As shown in [16], this equality implies the classical ‘pentagon identity’ for Rogers’ dilogarithm.

**1.3. Reineke’s identities.** Our aim in this section is to associate, following Reineke [57], an identity analogous to (1.3) with each simply laced Dynkin diagram so that the above identity corresponds to the diagram  $A_2$ .

So let  $\Delta$  be a simply laced Dynkin diagram and let  $Q$  be a quiver (=oriented graph) with underlying graph  $\Delta$ . We will associate a whole family of quantum dilogarithm products with  $Q$ . All these products will be equal and among the resulting equalities, we will obtain the required generalization of the pentagon identity (1.3). The quantum dilogarithm products will be constructed from ‘stability functions’ on the category of representations of  $Q$ .

We first need to introduce some notation: Let  $k$  be a field. Let  $\mathcal{A}$  be the category of representations of the opposite quiver  $Q^{op}$  with values in the category of finite-dimensional  $k$ -vector spaces (we refer to [59] [23] [4] [3] for quiver representations). Let  $I = \{1, \dots, n\}$  be the set of vertices of  $Q$ . For each vertex  $i$ , let  $S_i$  be the simple representation whose value at  $i$  is  $k$  and whose value at all other vertices is zero. Let  $K_0(\mathcal{A})$  be the Grothendieck group of  $\mathcal{A}$ . It is a finitely generated free abelian group and admits the classes of the representations  $S_i$ ,  $i \in I$ , as a basis.

A *stability function* on  $\mathcal{A}$  is a group homomorphism

$$Z : K_0(\mathcal{A}) \rightarrow \mathbb{C}$$

to the underlying abelian group of the field of complex numbers such that for each non zero object  $X$  of  $\mathcal{A}$ , the number  $Z(X)$  is non zero and its argument, called the *phase of  $X$* , lies in the interval  $[0, \pi[$ , cf. figure 1. A non zero object  $X$  of  $\mathcal{A}$  is *semi-stable* (respectively *stable*) if for each non zero proper subobject  $Y$  of  $X$ , the phase of  $Y$  is less than or equal to the phase of  $X$  (respectively strictly less than the phase of  $X$ ). Sometimes, the homomorphism  $Z$  is called a *central charge*. Since it is a group homomorphism, it is determined by the complex numbers  $Z(S_i)$ ,  $i \in I$ . Notice that each simple object of  $\mathcal{A}$  is stable (since it has no non zero proper subobjects).

**Proposition 1.4** (King [47]). *Let  $Z : K_0(\mathcal{A}) \rightarrow \mathbb{C}$  be a stability function. For each real number  $\mu$ , let  $\mathcal{A}_\mu$  be the full subcategory of  $\mathcal{A}$  whose objects are the zero object and the semistable objects of phase  $\mu$ .*

- a) *The subcategory  $\mathcal{A}_\mu$  of  $\mathcal{A}$  is stable under forming extensions, kernels and cokernels in  $\mathcal{A}$ . In particular, it is abelian and its inclusion into  $\mathcal{A}$  is exact. Its simple objects are precisely the stable objects of phase  $\mu$ .*

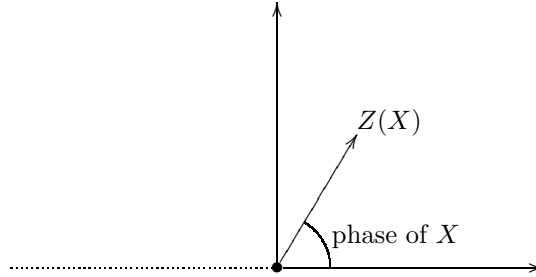

Figure 1. Image of a non zero object under the central charge

b) *Each object  $X$  admits a unique filtration*

$$0 = X_0 \subset X_1 \subset \dots \subset X_s = X$$

*whose subquotients are semistable with strictly decreasing phases. It is called the Harder-Narasimhan filtration (or HN-filtration) of  $X$ . Its subquotients are the HN-subquotients of  $X$ .*

Notice that by part a), all stable objects are indecomposable and their endomorphism algebras are (skew) fields.

Under the assumptions of the proposition, let  $\mathcal{A}_{\geq \mu}$  be the full subcategory of  $\mathcal{A}$  formed by the objects  $X$  all of whose HN-subquotients have phase greater than or equal to  $\mu$ . Define the full subcategory  $\mathcal{A}_{< \mu}$  analogously. Then the pair  $(\mathcal{T}, \mathcal{F}) = (\mathcal{A}_{\geq \mu}, \mathcal{A}_{< \mu})$  is a *torsion pair* in  $\mathcal{A}$ , i.e. for  $X$  in  $\mathcal{T}$  and  $Y$  in  $\mathcal{F}$ , we have  $\text{Hom}(X, Y) = 0$  and for each object  $Z$ , there is an exact sequence

$$0 \longrightarrow X \longrightarrow Z \longrightarrow Y \longrightarrow 0 ,$$

where  $X$  belongs to  $\mathcal{T}$  and  $Y$  to  $\mathcal{F}$ . Thus, each stability function  $Z$  determines a decreasing chain (indexed by the real numbers) of torsion subcategories  $\mathcal{A}_{\geq \mu}$ . Below, instead of working with stability functions, we could work more generally with decreasing chains of torsion subcategories (but stability functions are more pleasant to use).

As a first example, let us consider the case where  $Q$  is the quiver

$$1 \longrightarrow 2$$

of type  $A_2$ . Its Auslander-Reiten quiver is

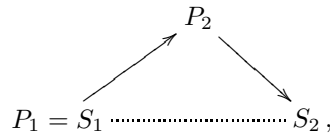

where  $S_1$  and  $S_2$  are the simple representations associated with the vertices and  $P_2$  the projective cover of  $S_2$  given by the identity map  $k \leftarrow k$  (we consider representations of  $Q^{op}$ ). In particular, the representation  $P_2$  is the only non simple

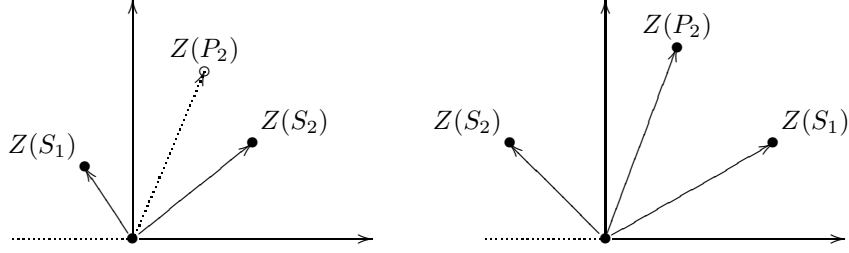
Figure 2. Two different generic stability functions for  $A_2$ 

indecomposable object and it has  $S_1$  as its unique non zero proper subobject. If we only consider *generic* stability functions (i.e. the central charge  $Z$  maps two non zero classes into the same straight line of  $\mathbb{C}$  only if they are  $\mathbb{Q}$ -proportional), there are essentially two possibilities: Either the phase of  $S_1$  is greater than that of  $S_2$  or the phase of  $S_1$  is smaller than that of  $S_2$ , cf. figure 2. Now the object  $P_2$ , whose class in  $K_0(\mathcal{A})$  is the sum of those of  $S_1$  and  $S_2$ , has the proper subobject  $S_1$ . In the first case,  $S_1$  is of greater phase than  $P_2$  and so  $P_2$  is unstable. In the second case,  $P_2$  is stable, since its only non zero proper subobject  $S_1$  has smaller phase. Thus, in the first case, we find *two* stable objects and in the second case *three*. Notice that these numbers agree with the numbers of factors in the two products appearing in the pentagon identity (1.3). In both cases, each semistable object of given phase  $\mu$  is a direct sum of copies of the unique stable object of phase  $\mu$ . Thus, these stability functions are discrete in the sense of the following definition.

**Definition 1.5.** A stability function  $K_0(\mathcal{A}) \rightarrow \mathbb{C}$  is discrete if, for each real number  $\mu$ , the subcategory of semistable objects  $\mathcal{A}_\mu$  is zero or semisimple with a unique simple object.

We will associate a product of quantum dilogarithms with each discrete stability function. We first need to define the algebra in which these products will be computed: Let  $n \geq 1$  be an integer and  $Q$  a finite quiver whose vertex set is the set of integers from 1 to  $n$ . For a  $kQ$ -module  $M$ , let the dimension vector  $\underline{\dim} M \in \mathbb{Z}^n$  have the components  $\dim(Me_i)$ . The map  $\underline{\dim}$  induces an isomorphism from  $K_0(\mathcal{A})$  onto  $\mathbb{Z}^n$ . Define the Euler form  $\langle \cdot, \cdot \rangle : \mathbb{Z}^n \times \mathbb{Z}^n \rightarrow \mathbb{Z}$  by

$$\langle \underline{\dim} L, \underline{\dim} M \rangle = \dim \operatorname{Hom}(L, M) - \dim \operatorname{Ext}^1(L, M).$$

Define  $\lambda : \mathbb{Z}^n \times \mathbb{Z}^n \rightarrow \mathbb{Z}$  to be opposite to the antisymmetrization of the Euler form so that we have

$$\lambda(\alpha, \beta) = \langle \beta, \alpha \rangle - \langle \alpha, \beta \rangle.$$

for all  $\alpha, \beta$  in  $\mathbb{Z}^n$ . Notice that  $\lambda(e_i, e_j)$  is the difference of the number of arrows from  $i$  to  $j$  minus the number of arrows from  $j$  to  $i$ . The *quantum affine space*

$\mathbb{A}_Q$  is the  $\mathbb{Q}(q^{1/2})$ -algebra generated by the variables  $y^\alpha$ ,  $\alpha \in \mathbb{N}^n$ , subject to the relations

$$y^\alpha y^\beta = q^{1/2 \lambda(\alpha, \beta)} y^{\alpha + \beta}$$

for all  $\alpha$  and  $\beta$  in  $\mathbb{N}^n$ . It is also generated by the variables  $y_i = y^{e_i}$ ,  $1 \leq i \leq n$ , subject to the relations

$$y_i y_j = q^{\lambda(e_i, e_j)} y_j y_i$$

and admits the monomials  $y^\alpha$ ,  $\alpha \in \mathbb{N}^n$ , as a basis over  $\mathbb{Q}(q^{1/2})$ . The *formal quantum affine space*  $\widehat{\mathbb{A}}_Q$  is the completion of  $\mathbb{A}_Q$  with respect to the ideal generated by the  $y_i$ ,  $i \in I$ .

**Theorem 1.6** (Reineke [57]). *Let  $k$  be a field,  $Q$  a Dynkin quiver and*

$$Z : K_0(\text{mod } kQ) \rightarrow \mathbb{C}$$

*a discrete stability function. Then the product computed in  $\widehat{\mathbb{A}}_Q$*

$$\mathbb{E}_{Q,Z} = \prod_{M \text{ stable}}^{\widehat{\phantom{x}}} \mathbb{E}(y^{\dim M}), \quad (1.4)$$

*where the factors are in the order of decreasing phase, is independent of the choice of  $Z$ .*

Recall that if  $Q$  is a quiver without oriented cycles, a *source* of  $Q$  is a vertex without incoming arrows; a *source sequence* for  $Q$  is an enumeration  $i_1, \dots, i_n$  of the vertices of  $Q$  such that each  $i_j$  is a source in the quiver obtained from  $Q$  by removing the vertices  $i_1, \dots, i_{j-1}$  and all arrows incident with one of these vertices. If  $Q$  is a Dynkin quiver, by Gabriel's theorem, each positive root  $\alpha$  of the corresponding root system is the dimension vector of an indecomposable representation  $V(\alpha)$ , unique up to isomorphism. We endow the set of positive roots with the smallest order relation such that  $\text{Hom}(V(\alpha), V(\beta)) \neq 0$  implies  $\alpha \leq \beta$ .

**Corollary 1.7.** *If  $Q$  is a Dynkin quiver, we have*

$$\mathbb{E}(y_{i_1}) \dots \mathbb{E}(y_{i_n}) = \mathbb{E}(y^{\alpha_1}) \dots \mathbb{E}(y^{\alpha_N}),$$

*where  $i_1, \dots, i_n$  is a source sequence for  $Q$  and  $\alpha_1, \dots, \alpha_N$  are the dimension vectors of the indecomposable representations enumerated in decreasing order with respect to the above defined order relation*

Clearly, for the quiver  $Q : 1 \rightarrow 2$ , the corollary specializes to Schützenberger-Faddeev-Kashaev's theorem. In this case, we deduce it from the theorem by comparing  $\mathbb{E}_{Q,Z}$  for the two generic stability functions considered above. To deduce the corollary from the theorem in the general case, we need to construct stability functions  $Z_1$  and  $Z_2$  such that

- for  $Z_1$ , the only stable objects are the simples and  $S_{i_1}, \dots, S_{i_n}$  have strictly decreasing phases;

- for  $Z_2$ , the stable objects are precisely the indecomposable representations and their phases increase from left to right in the Auslander-Reiten quiver.

The existence of  $Z_1$  is not hard to check. The existence of  $Z_2$  was a conjecture by Reineke [57] first proved by Hille-Juteau (unpublished) which can be shown using the methods of section 2.6 of [31]. In [57], the corollary is proved using only the HN-filtrations associated with  $Z_2$ , which are easy to construct directly without assuming the existence of  $Z_2$  itself.

**1.8. The Kronecker quiver.** Let us emphasize that the main thrust of Reineke's work in [57] and Kontsevich–Soibelman's work in [51] and [50] bears on the general case of not necessarily discrete stability functions. As an example, consider the Kronecker quiver

$$1 \begin{array}{c} \xrightarrow{\quad} \\ \xrightarrow{\quad} \end{array} 2 .$$

For a stability function such that the phase of  $S_1$  is strictly greater than the one of  $S_2$ , the simples are the only stable objects, which leads to the product

$$\mathbb{E}(y_1)\mathbb{E}(y_2) \tag{1.5}$$

For a stability function such that the phase of  $S_1$  is strictly smaller than the one of  $S_2$ , the stable representations are precisely the postprojective indecomposables, the preinjective indecomposables and the representations in the  $\mathbb{P}^1$ -family

$$\mathbb{C} \begin{array}{c} \xleftarrow{x_1} \\ \xleftarrow{x_0} \end{array} \mathbb{C} , (x_0 : x_1) \in \mathbb{P}^1(\mathbb{C}).$$

In this case, Reineke and Kontsevich–Soibelman obtain the product (*cf.* equation (2.24) of [26])

$$(\mathbb{E}(0, 1)\mathbb{E}(1, 2)\mathbb{E}(2, 3) \dots) \mathbb{E}(1, 1)^4 \mathbb{E}(2, 2)^{-2} (\dots \mathbb{E}(3, 2)\mathbb{E}(2, 1)\mathbb{E}(1, 0)) , \tag{1.6}$$

where we write  $\mathbb{E}(a, b)$  instead of  $\mathbb{E}(y^{ae_1+be_2})$ . An elementary proof of the identity between the expressions (1.5) and (1.6) can be found in Appendix A of [26].

## 2. Sketch of proof of Reineke's theorem

Let us fix a discrete stability condition  $Z : K_0(\text{mod } kQ) \rightarrow \mathbb{C}$ . Since  $Q$  is a Dynkin quiver, its representation theory is 'independent of  $k$ '. In particular, the stability function  $Z$  is discrete for any choice of  $k$  and the dimension vectors of the stable objects do not depend on  $k$ . So the product (1.4) is independent of  $k$ .

Now notice that the coefficients of the series  $\mathbb{E}_{Q,Z}$  in (1.4) lie in the subring  $R$  of  $\mathbb{Q}(q^{1/2})$  obtained from the polynomial ring  $\mathbb{Q}[q^{1/2}]$  by inverting  $q^{1/2}$  and all the polynomials  $q^l - 1$ ,  $l \geq 1$ . Thus, in order to prove that  $\mathbb{E}_{Q,Z}$  is independent of  $Z$ , it suffices to show that its image under specializing  $q$  to any prime power  $p^m$  is independent of  $Z$ .



So let us assume now that  $q$  is a prime power  $p^m$  and that  $k$  is a finite field with  $q$  elements. Let  $\mathcal{A}$  be the category of finite-dimensional  $kQ$ -modules. We consider the completed (non twisted, opposite) Ringel-Hall algebra  $\widehat{\mathcal{H}}(\mathcal{A})$ : its elements are formal series with rational coefficients

$$\sum_{[M] \in [\mathcal{A}]} a_M [M],$$

where the sum is taken over the set  $[\mathcal{A}]$  of isomorphism classes  $[M]$  of  $k$ -finite-dimensional right  $kQ$ -modules  $M$ . The product of  $\widehat{\mathcal{H}}(\mathcal{A})$  is the continuous bilinear map determined by

$$[L][M] = \sum c_{LM}^N [N],$$

where  $c_{LM}^N$  is the number of submodules  $L'$  of  $N$  which are isomorphic to  $L$  and such that  $N/L'$  is isomorphic to  $M$ .

By King's Proposition 1.4, each  $kQ$ -module  $M$  admits a unique HN-filtration with semistable subquotients of strictly decreasing phase. In the Ringel-Hall algebra, this translates into the identity

$$\sum_{[M] \in [\mathcal{A}]} [M] = \prod_{\mu \text{ decreasing } [\mathcal{A}_\mu]} \sum [L], \quad (2.1)$$

where the sum on the left is taken over all isomorphism classes, the product on the right over the possible (rational) phases in decreasing order and each factor is the sum over the isomorphism classes of semi-stable modules  $L$  with phase  $\mu$ . This identity shows that the product on the right hand side is in fact independent of the choice of  $Z$ . It remains to 'transport' this identity from the Hall algebra to our algebra of non commutative power series. For this, we define  $\widehat{\mathbb{A}}_{Q, \text{spec}}$  to be the algebra obtained by specializing  $q = p^m$  in the subring of  $\widehat{\mathbb{A}}_Q$  formed by the series with coefficients in the ring  $R$  defined above and we define the *integration map*

$$\int : \widehat{\mathcal{H}}(\mathcal{A}) \rightarrow \widehat{\mathbb{A}}_{Q, \text{spec}}$$

to be the continuous  $\mathbb{Q}$ -linear map which takes the class  $[M]$  of a module to

$$q^{1/2 \langle \underline{\dim} M, \underline{\dim} M \rangle} \frac{y^{\underline{\dim} M}}{|\text{Aut}(M)|},$$

where  $|\text{Aut}(M)|$  is the order of the automorphism group of  $M$ , the notation  $\underline{\dim} M$  denotes the class of  $M$  in  $K_0(\mathcal{A})$  and the form  $\langle, \rangle$  is the *Euler form* defined by

$$\langle \underline{\dim} L, \underline{\dim} M \rangle = \dim \text{Hom}(L, M) - \dim \text{Ext}^1(L, M).$$

**Lemma 2.1.** *The integration map is an algebra homomorphism.*

For a proof, see for example Lemma 1.7 of [60] or Lemma 6.1 of [56]. One easily computes that if  $M$  is a module with  $\text{End}(M) = k$ , then we have

$$\int \sum [M^n] = \mathbb{E}(y^{\dim M}).$$

Hence if we apply the integration map to the identity (2.1) and use the fact that all objects of  $\mathcal{A}_\mu$  are sums of a unique stable object, we find the equality

$$\int \sum_{[\mathcal{A}]} [L] = \prod_{M \text{ stable}} \mathbb{E}(y^{\dim M}),$$

where the factors on the right appear in the order of decreasing phase. This equality clearly shows that the right hand side does not depend on the choice of  $Z$ .

### 3. Quantum dilogarithm identities from quivers with potential, after Kontsevich-Soibelman

**3.1. DT-invariants for quivers with potential.** Let  $Q$  be a finite quiver and  $k$  a field. Let  $kQ$  be the path algebra of  $Q$  and  $\widehat{kQ}$  its completion with respect to path length. Thus, the paths in  $Q$  form a topological basis of  $\widehat{kQ}$ . The continuous zeroth Hochschild homology of the completed path algebra

$$HH_0(\widehat{kQ})$$

is the completion of the quotient of the topological linear space  $\widehat{kQ}$  by the subspace  $[\widehat{kQ}, \widehat{kQ}]$  of all commutators. It has a topological basis formed by the classes (modulo cyclic permutation) of cyclic paths of  $Q$ . For each arrow  $\alpha$  of  $Q$ , we have the *cyclic derivative*

$$\partial_\alpha : HH_0(\widehat{kQ}) \rightarrow \widehat{kQ}$$

which is the continuous linear map taking the equivalence class of a path  $p$  to the sum

$$\sum vu$$

taken over all decompositions  $p = u\alpha v$ . A *potential on  $Q$*  is an element  $W$  of  $HH_0(\widehat{kQ})$  which does not involve cycles of length  $\leq 2$ . A potential is *polynomial* if it is linear combination of finitely many cycles. The *Jacobian algebra*  $\mathcal{P}(Q, W)$  is the quotient of  $\widehat{kQ}$  by the twosided ideal generated by the cyclic derivatives  $\partial_\alpha W$ , where  $\alpha$  runs through the arrows of  $Q$ . We define

$$\text{nil}(\mathcal{P}(Q, W))$$

to be the category of finite-dimensional right  $\mathcal{P}(Q, W)$ -modules (such a module is automatically nilpotent, *i.e.* each element is annihilated by all long enough paths).

Clearly, this is an abelian category where each object has finite length and whose simples are the modules  $S_i$  associated with the vertices  $i$  of  $Q$ . The author thanks M. Kontsevich for informing him [49] that the following statement is still conjectural.

**Conjecture 3.2.** *Suppose that  $k = \mathbb{C}$  and that  $W$  is a polynomial potential. Suppose that we have a discrete stability function*

$$Z : K_0(\text{nil}(\mathcal{P}(Q, W))) \rightarrow \mathbb{C}.$$

Then the product

$$\mathbb{E}_{Q,W,Z} = \prod_{M \text{ stable}}^{\sim} \mathbb{E}(y^{\dim M}),$$

where the factors appear in the order of decreasing phase, is independent of the choice of  $Z$ .

Evidence for the conjecture comes from Kontsevich–Soibelman’s deep work in [51] [50]. With a (much) better definition of  $\mathbb{E}_{Q,W,Z}$ , it generalizes to arbitrary stability functions  $Z$  and is in fact expected to hold for not necessarily polynomial potentials. The strategy one would like to adopt for the proof is similar to Reineke’s but

- we have to work over the complex numbers and have to replace the Hall algebra by the ‘motivic Hall algebra’, cf. [33, 34, 35, 37] as well as [51] [8],
- the existence of the integration map remains conjectural (it is stated as a theorem in section 6.3 of [51] and an important ingredient for its still incomplete proof is the integral identity studied in section 7.8 of [50]).

For the quivers with potential  $(Q, W)$  satisfying the claim of the conjecture, the *refined DT-invariant* is defined as

$$\mathbb{E}_{Q,W} = \mathbb{E}_{Q,W,Z}, \quad (3.1)$$

where  $Z$  is any discrete stability function.

**3.3. Remark on the scaling factor.** In fact, Kontsevich–Soibelman consider the motivic Hall algebra not of the abelian category  $\text{nil } \mathcal{P}(Q, W)$  but of the triangulated 3-Calabi-Yau category  $\mathcal{D}_{fd}\Gamma(Q, W)$  defined in section 4.2 below. This category contains  $\text{nil } \mathcal{P}(Q, W)$  as the heart of the natural  $t$ -structure. The structure of this larger Hall algebra is unknown except in the case where the quiver  $Q$  has one vertex (labeled 1) and no arrows. In this case, the Hall algebra  $\mathcal{H}$  of the corresponding category defined over a finite field is described explicitly in [46]. The description shows that the largest commutative quotient of  $\mathcal{H}$  is the algebra

$$\mathbb{Q}(q^{1/2})[z_i \mid i \in \mathbb{Z}] / (z_{i+1}z_i = \frac{q}{(q-1)^2}), \quad (3.2)$$

where the generator  $z_i$  is the image of the shifted simple module  $\Sigma^{-i}S_1$ , *cf.* Theorem 5.1 and Lemma 6.1 of [loc. cit.]. Now notice that for the quiver  $Q$  (which does not have arrows), the algebra  $\mathbb{A}_Q$  is commutative. Let us denote by  $\Sigma$  its automorphism mapping the generator  $y_1$  to  $y_1^{-1}$ . Using (3.2) we see that there is a unique  $\mathbb{Q}(q^{1/2})$ -algebra homomorphism

$$\int : \mathcal{H} \rightarrow \mathbb{A}_Q$$

such that we have  $\int \circ \Sigma = \Sigma \circ \int$  and that the image of  $z_0$  is a scalar multiple of  $y_1$ . We clearly have

$$\int z_0 = \frac{q^{1/2}}{q-1} y_1.$$

This explains the choice of the scaling factor in the definition of  $\mathbb{E}(y)$  in equation (1.2).

## 4. DT-invariants and mutations

**4.1. The comparison problem.** Let  $(Q, W)$  be a quiver with a polynomial potential as in section 3 and assume that conjecture 3.2 holds for  $(Q, W)$  so that the refined DT-invariant  $\mathbb{E}_{Q, W}$  is well-defined. Let  $k$  be a vertex of  $Q$  not lying on a loop or a 2-cycle. Then the mutated quiver with potential  $(Q', W') = \mu_k(Q, W)$  is well-defined, *cf.* [13]. Let us assume that  $W'$  is again polynomial and that conjecture 3.2 holds for  $(Q', W')$  as well. Then, according to section 3, we have well-defined refined DT-invariants

$$\mathbb{E}_{Q, W} \in \widehat{\mathbb{A}}_Q \text{ and } \mathbb{E}_{Q', W'} \in \widehat{\mathbb{A}}_{Q'}.$$

We wish to compare them. For this, we need to recall the links between the abelian categories  $\mathcal{A}$  and  $\mathcal{A}'$  of nilpotent modules over  $\mathcal{P}(Q, W)$  respectively  $\mathcal{P}(Q', W')$ . We do this without supposing that  $W$  or  $W'$  are polynomial. We mainly follow section 8 of [51] and [52].

**4.2. The setup.** Let  $Q$  be a finite quiver and  $W$  a potential on  $Q$  (*cf.* section 3.1). Let  $\Gamma$  be the Ginzburg [29] dg algebra of  $(Q, W)$ . It is constructed as follows: Let  $\widetilde{Q}$  be the graded quiver with the same vertices as  $Q$  and whose arrows are

- the arrows of  $Q$  (they all have degree 0),
- an arrow  $a^* : j \rightarrow i$  of degree  $-1$  for each arrow  $a : i \rightarrow j$  of  $Q$ ,
- a loop  $t_i : i \rightarrow i$  of degree  $-2$  for each vertex  $i$  of  $Q$ .

The underlying graded algebra of  $\Gamma(Q, W)$  is the completion of the graded path algebra  $k\widetilde{Q}$  in the category of graded vector spaces with respect to the ideal generated by the arrows of  $\widetilde{Q}$ . Thus, the  $n$ -th component of  $\Gamma(Q, W)$  consists of elements

of the form  $\sum_p \lambda_p p$ , where  $p$  runs over all paths of degree  $n$ . The differential of  $\Gamma(Q, W)$  is the unique continuous linear endomorphism homogeneous of degree 1 which satisfies the Leibniz rule

$$d(uv) = (du)v + (-1)^p u dv ,$$

for all homogeneous  $u$  of degree  $p$  and all  $v$ , and takes the following values on the arrows of  $\tilde{Q}$ :

- $da = 0$  for each arrow  $a$  of  $Q$ ,
- $d(a^*) = \partial_a W$  for each arrow  $a$  of  $Q$ ,
- $d(t_i) = e_i(\sum_a [a, a^*])e_i$  for each vertex  $i$  of  $Q$ , where  $e_i$  is the lazy path at  $i$  and the sum runs over the set of arrows of  $Q$ .

The Ginzburg algebra should be viewed as a refined version of the Jacobian algebra  $\mathcal{P}(Q, W)$ . It is concentrated in (cohomological) degrees  $\leq 0$  and  $H^0(\Gamma)$  is isomorphic to  $\mathcal{P}(Q, W)$ . We refer to [45] for more details on the setup which we now describe. Let  $\mathcal{D}(\Gamma)$  be the derived category of  $\Gamma$ ,  $\text{per}(\Gamma)$  the perfect derived category and  $\mathcal{D}_{fd}\Gamma$  the full subcategory of  $\mathcal{D}(\Gamma)$  formed by the dg modules whose homology is of finite total dimension. The category  $\mathcal{D}_{fd}\Gamma$  is in fact contained in  $\text{per}(\Gamma)$ . It is triangulated, has finite-dimensional morphism spaces (even its graded morphism spaces are of finite total dimension) and is 3-Calabi-Yau, by which we mean that we have bifunctorial isomorphisms

$$D\text{Hom}(X, Y) \xrightarrow{\sim} \text{Hom}(Y, \Sigma^3 X) ,$$

where  $D$  is the duality functor  $\text{Hom}_k(?, k)$  and  $\Sigma$  the shift functor. The simple  $\mathcal{P}(Q, W)$ -modules  $S_i$  can be viewed as  $\Gamma$ -modules via the canonical morphism  $\Gamma \rightarrow H^0(\Gamma)$ . They then become 3-spherical objects in  $\mathcal{D}_{fd}\Gamma$ . They yield the Seidel-Thomas [62] twist functors  $\text{tw}_{S_i}$ . These are autoequivalences of  $\mathcal{D}\Gamma$  such that each object  $X$  fits into a triangle

$$\text{RHom}(S_i, X) \otimes_k S_i \rightarrow X \rightarrow \text{tw}_{S_i}(X) \rightarrow \Sigma \text{RHom}(S_i, X) \otimes_k S_i .$$

By [62], the twist functors give rise to a (weak) action on  $\mathcal{D}(\Gamma)$  of the braid group associated with  $Q$ , i.e. the group with generators  $\sigma_i$ ,  $i \in Q_0$ , and relations  $\sigma_i \sigma_j = \sigma_j \sigma_i$  if  $i$  and  $j$  are not linked by an arrow and

$$\sigma_i \sigma_j \sigma_i = \sigma_j \sigma_i \sigma_j$$

if there is exactly one arrow between  $i$  and  $j$  (no relation if there are two or more arrows).

The category  $\mathcal{D}(\Gamma)$  admits a natural  $t$ -structure whose truncation functors are those of the natural  $t$ -structure on the category of complexes of vector spaces (because  $\Gamma$  is concentrated in degrees  $\leq 0$ ). Thus, we have an induced natural  $t$ -structure on  $\mathcal{D}_{fd}\Gamma$ . Its heart  $\mathcal{A}$  is canonically equivalent to the category

$\text{nil}(\mathcal{P}(Q, W))$ . In particular, the inclusion of  $\mathcal{A}$  into  $\mathcal{D}_{fd}\Gamma$  induces an isomorphism in the Grothendieck groups

$$K_0(\mathcal{A}) \xrightarrow{\sim} K_0(\mathcal{D}_{fd}\Gamma).$$

Notice that the lattice  $K_0(\mathcal{D}_{fd}\Gamma)$  carries the canonical form defined by

$$\lambda(X, Y) = \sum_{p \in \mathbb{Z}} (-1)^p \dim \text{Hom}(X, \Sigma^p Y).$$

It is skew-symmetric thanks to the 3-Calabi-Yau property. It also follows from the Calabi-Yau property and from the fact that  $\text{Ext}_{\mathcal{A}}^i(L, M) = \text{Ext}^i(L, M)$  for  $i = 0$  and  $i = 1$  (but not  $i > 1$  in general!) that for two objects  $L$  and  $M$  of  $\mathcal{A}$ , we have

$$\lambda(L, M) = \dim \text{Hom}(L, M) - \dim \text{Ext}^1(L, M) + \dim \text{Ext}^1(M, L) - \dim \text{Hom}(M, L).$$

Since the dimension of  $\text{Ext}^1(S_i, S_j)$  equals the number of arrows in  $Q$  from  $j$  to  $i$ , we obtain that the matrix of  $\lambda$  in the basis of the simples of  $\mathcal{A}$  has its  $(i, j)$ -coefficient equal to the number of arrows from  $i$  to  $j$  minus the number of arrows from  $j$  to  $i$  in  $Q$ .

Suppose that  $\Lambda$  is a lattice endowed with a skew-symmetric bilinear form  $\lambda : \Lambda \times \Lambda \rightarrow \mathbb{Z}$ . Let  $C \subset \Lambda$  be a cone (a subset containing 0 and stable under forming sums). Then we define the  $\mathbb{Q}(q^{1/2})$ -algebra  $\mathbb{A}_C$  to be generated by the symbols  $y^\alpha$ ,  $\alpha \in C$ , subject to the relations

$$y^\alpha y^\beta = q^{1/2 \cdot \lambda(\alpha, \beta)} y^{\alpha + \beta}.$$

If  $C$  does not contain  $-\alpha$  for any non zero  $\alpha$  in  $C$ , we define  $\widehat{\mathbb{A}}_C$  to be the completion of  $\mathbb{A}_C$  with respect to the ideal generated by the  $y^\alpha$ ,  $\alpha \neq 0$ .

Via the identification  $y_i = y^{|S_i|}$ , we can now interpret the algebra  $\widehat{\mathbb{A}}_Q$  of section 1 intrinsically as the algebra  $\widehat{\mathbb{A}}_{K_0^+(\mathcal{A})}$  associated with the cone  $K_0^+(\mathcal{A})$  of positive elements in the Grothendieck group  $K_0(\mathcal{A})$ , which we endow with the form induced from that of  $K_0(\mathcal{D}_{fd}\Gamma)$  via the canonical isomorphism  $K_0(\mathcal{A}) \xrightarrow{\sim} K_0(\mathcal{D}_{fd}\Gamma)$ .

**4.3. Comparison of categories.** Keep the notations from the preceding section. In addition, let  $k$  be a vertex of  $Q$  not lying on a 2-cycle and let  $(Q', W')$  be the mutation of  $(Q, W)$  at  $k$  in the sense of [13]. Let  $\Gamma'$  be the Ginzburg algebra associated with  $(Q', W')$ . Let  $\mathcal{A}'$  be the canonical heart  $\mathcal{A}'$  in  $\mathcal{D}_{fd}\Gamma'$ . There are two canonical equivalences [45]

$$\mathcal{D}\Gamma' \rightarrow \mathcal{D}\Gamma$$

given by functors  $\Phi_\pm$  related by

$$\text{tw}_{S_k} \circ \Phi_- \xrightarrow{\sim} \Phi_+.$$

If we put  $P_i = e_i \Gamma$ ,  $i \in Q_0$ , and similarly for  $\Gamma'$ , then both  $\Phi_+$  and  $\Phi_-$  send  $P'_i$  to  $P_i$  for  $i \neq k$ ; the images of  $P'_k$  under the two functors fit into triangles

$$P_k \longrightarrow \bigoplus_{k \rightarrow i} P_i \longrightarrow \Phi_-(P'_k) \longrightarrow \Sigma P_k$$

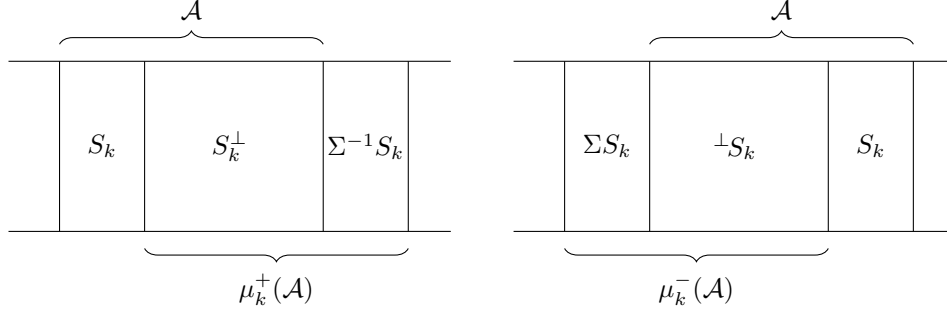

Figure 3. Right and left mutation of a heart

and

$$\Sigma^{-1}P_k \longrightarrow \Phi_+(P'_k) \longrightarrow \bigoplus_{j \rightarrow k} P_j \longrightarrow P_k .$$

The functors  $\Phi_\pm$  send  $\mathcal{A}'$  onto the hearts  $\mu_k^\pm(\mathcal{A})$  of two new t-structures. These can be described in terms of  $\mathcal{A}$  and the subcategory  $\text{add } S_k$  as follows (cf. figure 3): Let  $S_k^\perp$  be the right orthogonal subcategory of  $S_k$  in  $\mathcal{A}$ , whose objects are the  $M$  with  $\text{Hom}(S_k, M) = 0$ . Then  $\mu_k^+(\mathcal{A})$  is formed by the objects  $X$  of  $\mathcal{D}_{fd}\Gamma$  such that the object  $H^0(X)$  belongs to  $S_k^\perp$ , the object  $H^1(X)$  belongs to  $\text{add } S_k$  and  $H^p(X)$  vanishes for all  $p \neq 0, 1$ . Similarly, the subcategory  $\mu_k^-(\mathcal{A})$  is formed by the objects  $X$  such that the object  $H^0(X)$  belongs to the left orthogonal subcategory  ${}^\perp S_k$ , the object  $H^{-1}(X)$  belongs to  $\text{add}(S_k)$  and  $H^p(X)$  vanishes for all  $p \neq -1, 0$ . The subcategory  $\mu_k^+(\mathcal{A})$  is the *right mutation* of  $\mathcal{A}$  and  $\mu_k^-(\mathcal{A})$  is its *left mutation*.

The construction of these subcategories is very similar to that of the tilts of [30] but notice that in contrast to the setting of [30], we usually do not have an equivalence between the bounded derived category  $\mathcal{D}^b(\mathcal{A})$  and the ambient Calabi-Yau category  $\mathcal{D}_{fd}\Gamma$ . By construction, we have

$$\text{tw}_{S_k}(\mu_k^-(\mathcal{A})) = \mu_k^+(\mathcal{A}).$$

Since the categories  $\mathcal{A}$  and  $\mu^\pm(\mathcal{A})$  are hearts of bounded, non degenerate t-structures on  $\mathcal{D}_{fd}\Gamma$ , their Grothendieck groups identify canonically with that of  $\mathcal{D}_{fd}\Gamma$ . They are endowed with canonical bases given by the simples. Those of  $\mathcal{A}$  identify with the simples  $S_i$ ,  $i \in Q_0$ , of  $\text{nil}(\mathcal{P}(Q, W))$ . The simples of  $\mu_k^+(\mathcal{A})$  are  $\Sigma^{-1}S_k$ , the simples  $S_i$  of  $\mathcal{A}$  such that  $\text{Ext}^1(S_k, S_i)$  vanishes and the objects  $\text{tw}_{S_k}(S_i)$  where  $\text{Ext}^1(S_k, S_i)$  is of dimension  $\geq 1$ . By applying  $\text{tw}_{S_k}^{-1}$  to these objects we obtain the simples of  $\mu_k^-(\mathcal{A})$ .

**4.4. Comparison of the invariants.** Let us keep the notations of the preceding sections. Let us assume moreover that the refined DT-invariants  $\mathbb{E}_{Q,W}$  and  $\mathbb{E}_{Q',W'}$  are well-defined.

The two realizations  $\mu_k^\pm(\mathcal{A})$  of  $\mathcal{A}'$  as a subcategory of  $\mathcal{D}_{fd}\Gamma$  yield two ways of comparing  $\mathbb{E}_{Q,W}$  with  $\mathbb{E}_{Q',W'}$ . Let us consider the category  $\mu_k^+(\mathcal{A})$ , which is

equivalent via  $\Phi_+$  to  $\mathcal{A}'$ . We have the algebras

$$\widehat{\mathbb{A}}_Q = \widehat{\mathbb{A}}_{K_0^+(\mathcal{A})} \quad \text{and} \quad \widehat{\mathbb{A}}_{K_0^+(\mu_k^+(\mathcal{A}))}.$$

associated with the positive cones of the Grothendieck groups of  $\mathcal{A}$  and  $\mu_k^+(\mathcal{A})$ . They have a common subalgebra  $\widehat{\mathbb{A}}_{[S_k^\perp]}$  associated with the cone  $[S_k^\perp]$  formed by the classes of the objects in the right orthogonal subcategory of  $S_k$ .

We choose a stability function  $Z$  on  $K_0(\mathcal{A})$  such that  $S_k$  has the strictly largest phase among all semi-stable objects. Then we obtain a factorization

$$\mathbb{E}_{Q,W} = \mathbb{E}_{S_k} \mathbb{E}_{S_k^\perp}, \quad (4.1)$$

where the second factor is associated with the right orthogonal category  $S_k^\perp$  (if  $Z$  is discrete, this factor is the product of the dilogarithms corresponding to the stable objects in  $S_k^\perp$ ). Now via the canonical identifications

$$K_0(\mathcal{A}) = K_0(\mathcal{D}_{fd}\Gamma) = K_0(\mu_k^+(\mathcal{A})),$$

we can use the same stability function  $Z$  for  $\mu_k^+(\mathcal{A})$  and then the object  $\Sigma^{-1}S_k$  has the strictly smallest phase among all semi-stable objects, cf. figure 4. Moreover, one checks that an object  $X$  of  $S_k^\perp$  is  $Z$ -stable (resp.  $Z$ -semi-stable) in  $\mathcal{A}$  iff it is  $Z$ -stable (resp.  $Z$ -semi-stable) in  $\mu_k^+(\mathcal{A})$ . Therefore, we obtain a factorization

$$\varphi_+(\mathbb{E}_{Q',W'}) = \mathbb{E}_{S_k^\perp} \mathbb{E}_{\Sigma^{-1}S_k}, \quad (4.2)$$

where  $\varphi_+ : \widehat{\mathbb{A}}_{Q'} \rightarrow \widehat{\mathbb{A}}_{K_0^+(\mu_k^+(\mathcal{A}))}$  is induced by the isomorphism  $K_0(\mathcal{A}') \rightarrow K_0(\mu_k^+(\mathcal{A}))$  provided by the equivalence  $\Phi_+$ . Thus, we have

$$\varphi_+(y_i) = \begin{cases} y_k^{-1} & \text{if } i = k \\ y_i & \text{if there is no arrow } i \rightarrow k \text{ in } Q \\ q^{-m^2/2} y_i y_k^m & \text{if there are } m \geq 1 \text{ arrows } i \rightarrow k \text{ in } Q \end{cases} \quad (4.3)$$

By combining equations (4.1) and (4.2) we obtain the equality

$$\mathbb{E}_{S_k}^{-1} \mathbb{E}_{Q,W} = \mathbb{E}_{S_k^\perp} = \varphi_+(\mathbb{E}_{Q',W'}) \mathbb{E}_{\Sigma^{-1}S_k}^{-1} \quad (4.4)$$

in  $\widehat{\mathbb{A}}_{[S_k^\perp]}$ . Similarly, one obtains the equality

$$\mathbb{E}_{Q,W} \mathbb{E}_{S_k}^{-1} = \mathbb{E}_{\perp S_k} = \mathbb{E}_{\Sigma S_k}^{-1} \varphi_-(\mathbb{E}_{Q',W'}) \quad (4.5)$$

in the algebra  $\widehat{\mathbb{A}}_{[\perp S_k]}$ .

**4.5. The rational case.** Let us keep the notations of section 4.4. Notice that the series  $\mathbb{E}_{Q,W}$  is invertible in the algebra  $\widehat{\mathbb{A}}_Q$  and so the conjugation with this series, *i.e.* the automorphism

$$\text{Ad}(\mathbb{E}_{Q,W}) : u \mapsto \mathbb{E}_{Q,W} u \mathbb{E}_{Q,W}^{-1},$$



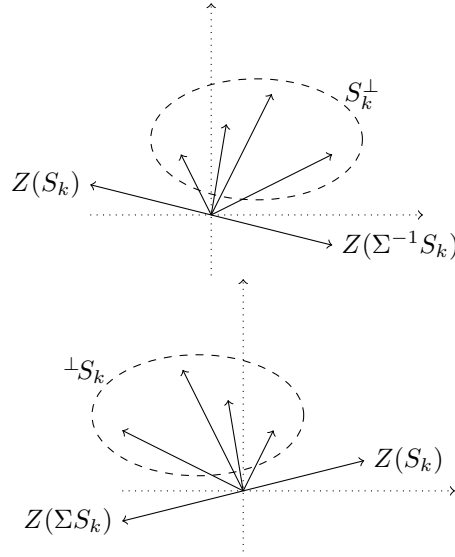

Figure 4. Stable objects in a heart and its right and left mutations

is well defined. An element  $u$  of  $\widehat{\mathbb{A}}_Q$  is *rational* if there is a non zero element  $s$  of the (non completed) algebra  $\mathbb{A}_Q$  such that  $su$  belongs to  $\mathbb{A}_Q$ . The rational elements of  $\widehat{\mathbb{A}}_Q$  form a subalgebra since the non zero elements of  $\mathbb{A}_Q$  satisfy the Ore conditions (by the appendix to [7]). The invariant  $\mathbb{E}_{Q,W}$  is *rational* if the automorphism  $\text{Ad}(\mathbb{E}_{Q,W})$  preserves the subalgebra of rational elements of  $\widehat{\mathbb{A}}_Q$ . Clearly, this holds iff  $\text{Ad}(\mathbb{E}_{Q,W})(y_i)$  is rational for each  $i \in Q_0$ . In this case, the automorphism  $\text{Ad}(\mathbb{E}_{Q,W})$  extends to an automorphism of the (non commutative) *fraction field*  $\text{Frac}(\mathbb{A}_Q)$  of the (non completed) algebra  $\mathbb{A}_Q$ , which is obtained from  $\mathbb{A}_Q$  by localizing at the set of all non zero elements.

**Lemma 4.6.** *If  $\mathcal{A}$  admits a discrete stability function with finitely many stables, then  $\mathbb{E}_{Q,W}$  is rational.*

*Proof.* Under the hypothesis, the automorphism  $\text{Ad}(\mathbb{E}_{Q,W})$  is a composition of finitely many automorphisms of the form  $\text{Ad}(\mathbb{E}(y^\alpha))$  and so it is enough to check that such an automorphism preserves  $\text{Frac}(\mathbb{A}_Q)$ . Indeed, one checks from the definition that

$$\mathbb{E}(y)(1 + q^{1/2}y) = \mathbb{E}(qy).$$

Therefore, for each  $m \geq 0$ , we have

$$\mathbb{E}(q^m y)\mathbb{E}(y)^{-1} = \prod_{j=1}^m (1 + q^{-1/2+j}y) \tag{4.6}$$

and

$$\mathbb{E}(q^{-m}y)\mathbb{E}(y)^{-1} = \prod_{j=1}^m (1 + q^{-m-1/2+j}y)^{-1}. \quad (4.7)$$

Now suppose that we have  $\alpha, \beta$  such that  $m = \lambda(\alpha, \beta)$  and therefore  $y^\alpha y^\beta = q^m y^\beta y^\alpha$  and

$$y^{-\beta} y^\alpha y^\beta = q^m y^\alpha.$$

Then we find

$$\begin{aligned} \mathbb{E}(y^\alpha) y^\beta \mathbb{E}(y^\alpha)^{-1} &= y^\beta y^{-\beta} \mathbb{E}(y^\alpha) y^\beta \mathbb{E}(y^\alpha)^{-1} \\ &= y^\beta \mathbb{E}(q^m y^\alpha) \mathbb{E}(y^\alpha)^{-1} \end{aligned}$$

By the above formulas (4.6) and (4.7), this expression does belong to  $\text{Frac}(\mathbb{A}_Q)$ .  $\square$

For example, if  $Q$  is a Dynkin quiver (and so  $W = 0$ ), then  $\mathbb{E}_{Q,W}$  is rational since we can find a discrete stability function whose stables are the simples. More generally, the same argument shows that  $\mathbb{E}_{Q,W}$  is rational for any acyclic quiver  $Q$ . Other examples of rational  $\mathbb{E}_{Q,W}$  arise from (*cf.* [40] for details):

- the quivers in Kontsevich-Soibelman's class  $\mathcal{P}$ , *cf.* section 8.4 of [51],
- the quivers with potential  $(Q, W)$  associated in Proposition 5.12 of [39] with pairs of acyclic quivers,
- the quivers with potential appearing in the work of Buan-Iyama-Reiten-Scott [5] respectively Geiss-Leclerc-Schröer [28], *cf.* [2].

On the other hand, the quiver

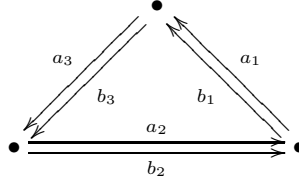

with the potential  $W = a_1 a_2 a_3 + b_1 b_2 b_3$  does not yield a rational invariant  $\mathbb{E}_{Q,W}$ , *cf.* section 8.4 of [51].

**4.7. The interwiners.** Let us keep the hypotheses of section 4.4 and suppose moreover that  $\mathbb{E}_{Q,W}$  is rational. Let  $\Sigma : \text{Frac}(\mathbb{A}_Q) \rightarrow \text{Frac}(\mathbb{A}_Q)$  be the automorphism mapping each  $y^\alpha$  to  $y^{-\alpha}$ . Define the *non commutative DT-invariant* to be the automorphism

$$DT_{Q,W} = \text{Ad}(\mathbb{E}_{Q,W}) \circ \Sigma$$

of  $\text{Frac}(\mathbb{A}_Q)$ . This invariant is preserved under left and right mutations up to conjugacy. Indeed, if we consider right mutation in the setting of section 4.4, the equality

$$\mathbb{E}_{S_k}^{-1} \mathbb{E}_{Q,W} = \mathbb{E}_{S_k^\perp} = \varphi_+(\mathbb{E}_{Q',W'}) \mathbb{E}_{\Sigma^{-1}S_k}^{-1} \quad (4.8)$$

yields

$$\mathrm{Ad}(\mathbb{E}(y_k))^{-1} \mathrm{Ad}(\mathbb{E}_{Q,W}) = \varphi_+ \mathrm{Ad}(\mathbb{E}_{Q',W'}) \varphi_+^{-1} \mathrm{Ad}(\mathbb{E}(y_k^{-1}))^{-1}$$

and if we pre-compose with  $\Sigma$  and post-compose with  $\mathrm{Ad}(\mathbb{E}(y_k))$ , we obtain

$$\mathrm{Ad}(\mathbb{E}_{Q,W}) \circ \Sigma = \mathrm{Ad}(\mathbb{E}(y_k)) \varphi_+ \mathrm{Ad}(\mathbb{E}_{Q',W'}) \Sigma \varphi_+^{-1} \mathrm{Ad}(\mathbb{E}(y_k))^{-1}$$

so that conjugation by the ‘right intertwiner’

$$\mathrm{Ad}(\mathbb{E}(y_k)) \circ \varphi_+ = \varphi_+ \circ \mathrm{Ad}(\mathbb{E}(y_k'^{-1})) : \mathrm{Frac}(\mathbb{A}_{Q'}) \rightarrow \mathrm{Frac}(\mathbb{A}_Q) \quad (4.9)$$

transforms  $DT_{Q',W'}$  into  $DT_{Q,W}$ . This is exactly the quantum mutation operator defined by Fock and Goncharov in section 3.1 of [17] (they write  $q$  for the indeterminate we denote by  $q^{1/2}$ ). If we consider left mutation, then the equation 4.5 yields the ‘left intertwiner’

$$\varphi_- \circ \mathrm{Ad}(\mathbb{E}(y_k))^{-1}. \quad (4.10)$$

Remarkably, as we will see in lemma 4.9 below, the right and left intertwiners (4.9) and (4.10) are *equal*. Explicitly, if  $r \geq 0$  is the number of arrows  $k \rightarrow i$  and  $s \geq 0$  the number of arrows  $i \rightarrow k$  in  $Q$ , they are both given by

$$\mathrm{Ad}(\mathbb{E}(y_k)) \circ \varphi_+(y_i') = \begin{cases} y_i \prod_{j=1}^r (1 + q^{-1/2+j} y_k) & \text{if } r > 0 \\ y_i & \text{if } r = s = 0 \\ y_i y_k^s q^{-s^2/2} \prod_{j=1}^s (1 + q^{1/2-j} y_k)^{-1} & \text{if } s > 0 \end{cases} \quad (4.11)$$

When  $q^{1/2}$  is specialized to 1 and  $Q$  replaced with  $Q^{op}$ , these formulas yield the transformation rule for  $Y$ -seeds in the sense of Fomin-Zelevinsky, *cf.* [22]. Notice that in deducing formula (4.9), we chose to pre-compose with  $\Sigma$ . If we post-compose with  $\Sigma$ , we obtain a variant of the intertwiner which fortunately has the same good properties and which, upon specialization of  $q^{1/2}$  to 1, yields Fomin-Zelevinsky’s transformation rule for  $Y$ -seeds (without replacing  $Q$  by  $Q^{op}$ ).

**4.8. Mutation is an involution.** In the setting of section 4.3, one checks easily that

$$\mu_k^+(\mu_k^-(\mathcal{A})) = \mathcal{A}.$$

We also know that  $\mu_k^+(\mathcal{A}) = \mathrm{tw}_{S_k}(\mu_k^-(\mathcal{A}))$ . Thus, we obtain

$$\mu_k^+(\mu_k^+(\mathcal{B})) = \mathrm{tw}_{S_k}(\mathcal{B})$$

for  $\mathcal{B} = \mu_k^-(\mathcal{A})$ . Thus, mutation of hearts is an involution only up to the braid group action. Remarkably, the mutation intertwiner (4.9) ‘squares’ to the identity (as do its variants) by the following lemma (*cf.* Lemma 3.7 of [18]), where we only write ‘unprimed’ variables to avoid clutter in the notation.

**Lemma 4.9.** a) *We have*

$$\mathrm{Ad}(\mathbb{E}(y_k)) \circ \mathrm{Ad}(\mathbb{E}(y_k^{-1})) = t_k^{-1}$$

where  $t_k : K_0(\mathcal{A}) \rightarrow K_0(\mathcal{A})$  is induced by the twist functor  $\mathrm{tw}_{S_k}$ .

b) *The composition*

$$\mathrm{Frac}(\mathbb{A}_{\mu_k^2(Q)}) \xrightarrow{\varphi_+ \circ \mathrm{Ad}(\mathbb{E}(y_k))} \mathrm{Frac}(\mathbb{A}_{Q'}) \xrightarrow{\varphi_+ \circ \mathrm{Ad}(\mathbb{E}(y_k))} \mathrm{Frac}(\mathbb{A}_Q)$$

is the identity.

c) *The right and left intertwiners  $\mathrm{Ad}(\mathbb{E}(y_k)) \circ \varphi_+$  and  $\varphi_- \circ \mathrm{Ad}(\mathbb{E}(y_k))^{-1}$  are equal.*

*Proof.* a) If  $y_k y_i = q^m y_i y_k$ , one computes, as in Lemma 4.6, that

$$\begin{aligned} \mathrm{Ad}(\mathbb{E}(y_k)) \mathrm{Ad}(\mathbb{E}(y_k^{-1})(y_i)) &= y_i \mathbb{E}(q^m y_k) \mathbb{E}(y_k)^{-1} \mathbb{E}(q^{-m} y_k^{-1}) \mathbb{E}(y_k^{-1})^{-1} \\ &= y^{e_i + m e_k} = t_k^{-1}(y_i). \end{aligned}$$

b) and c) are an easy consequences.  $\square$

## 5. Compositions of mutations

**5.1. The groupoid of cluster collections.** To state identities between longer compositions of intertwiners (4.9), we now introduce a suitable groupoid (a category where all morphisms are invertible). We fix a quiver with potential  $(Q, W)$  and work in the setup of section 4.2. A *cluster collection* [51] is a sequence of objects  $S'_1, \dots, S'_n$  of  $\mathcal{D}_{fd}\Gamma$  such that

- a) the  $S'_i$  are spherical;
- b) for  $i \neq j$ , either  $\mathrm{Ext}^1(S'_i, S'_j)$  or  $\mathrm{Ext}^1(S'_j, S'_i)$  vanishes;
- c) the  $S'_i$  generate the triangulated category  $\mathcal{D}_{fd}\Gamma$ .

One can show [58] [44] that in this case, the closure  $\mathcal{A}'$  of the  $S'_i$  under iterated extensions is the heart of a non degenerate bounded  $t$ -structure on  $\mathcal{D}_{fd}\Gamma$  and that the simples of  $\mathcal{A}'$  are the  $S'_i$  (up to isomorphism). On the other hand, if  $\mathcal{A}'$  is the heart of a non degenerate bounded  $t$ -structure on  $\mathcal{D}_{fd}\Gamma$ , then the simples  $(S'_1, \dots, S'_n)$  will satisfy c) but not necessarily a) and b). If they do, we call  $\mathcal{A}'$  a *cluster heart*. In this way, we obtain a bijection between cluster hearts and permutation classes of cluster collections, cf. [44].

The *groupoid of cluster collections*  $\mathrm{Ccl} = \mathrm{Ccl}_Q$  has as objects the cluster collections  $S'$  reachable from the sequence  $S = (S_1, \dots, S_n)$  of the simples of the initial cluster heart  $\mathcal{A}$  by a sequence

$$S = S^{(0)} \longrightarrow S^{(1)} \longrightarrow \dots \longrightarrow S^{(N)} = S'$$

of (positive and negative) mutations and permutations, where all the intermediate sequences  $S^{(i)}$  are cluster collections. The morphisms of  $\mathrm{Ccl}$  are the formal

compositions of mutations and permutations subject to the relations valid in the symmetric group and the relations

$$\sigma \circ \mu_k^\varepsilon = \mu_{\sigma(k)}^\varepsilon \circ \sigma$$

for all permutations  $\sigma$  and mutations  $\mu_k^\varepsilon$ . For example, for the quiver  $Q : 1 \rightarrow 2$ , with the notations of section 1.3, it is easy to check that we have the following two morphisms from  $(S_1, S_2)$  to  $(\Sigma^{-1}S_2, \Sigma^{-1}S_1)$  in  $\text{Ccl}$ :

$$(S_1, S_2) \xrightarrow{\mu_1^+} (\Sigma^{-1}S_1, S_2) \xrightarrow{\mu_2^+} (\Sigma^{-1}S_1, \Sigma^{-1}S_2) \xrightarrow{\tau} (\Sigma^{-1}S_2, \Sigma^{-1}S_1) \quad (5.1)$$

$$(S_1, S_2) \xrightarrow{\mu_2^+} (P_2, \Sigma^{-1}S_2) \xrightarrow{\mu_1^+} (\Sigma^{-1}P_2, S_1) \xrightarrow{\mu_2^+} (\Sigma^{-1}S_2, \Sigma^{-1}S_1) \quad (5.2)$$

Given a cluster collection  $S' = (S'_1, \dots, S'_n)$  its quiver  $Q_{S'}$  has the vertex set  $\{1, \dots, n\}$  and the number of arrows from  $i$  to  $j$  equals the dimension of  $\text{Ext}^1(S'_j, S'_i)$ . Using the intertwiners (4.9) and the natural action of the permutation groups, we clearly obtain a functor

$$\text{FG} : \text{Ccl}^{op} \rightarrow \text{Sf},$$

to the groupoid  $\text{Sf}$  of skew fields which takes a cluster collection  $S'$  to  $\text{Frac}(\mathbb{A}_{Q_{S'}})$ . The following theorem is a corollary of the theory of cluster algebras and their (additive) categorification as developed by Fomin-Zelevinsky, Berenstein-Fomin-Zelevinsky, Fock-Goncharov, Derksen-Weyman-Zelevinsky . . . .

**Theorem 5.2.** *The image of a morphism  $\alpha : S \rightarrow S'$  of the groupoid of cluster collections under the functor  $\text{FG}$  only depends on the orbit of  $S'$  under the braid group  $\text{Braid}(Q)$ .*

We will sketch a proof in section 5.13 below. Notice that already the statement that the image of  $\alpha$  only depends on  $S'$  is very strong. By the easy Lemma 4.9, it implies the statement of the theorem. As an example, consider the two morphisms (5.1) and (5.2). By the theorem, they yield the equality

$$\text{Ad}(\mathbb{E}(y_1))\varphi_1 \text{Ad}(\mathbb{E}(y_2))\varphi_2 \tau = \text{Ad}(\mathbb{E}(y_2))\varphi_2 \text{Ad}(\mathbb{E}(y_1))\varphi_1 \text{Ad}(\mathbb{E}(y_2))\varphi_2 \quad (5.3)$$

in the groupoid  $\text{Sf}$ . Notice that the symbols  $\varphi_1$  and  $\varphi_2$  denote different maps depending on the source and target fields. They are given, in the order of occurrence above, by the matrices

$$\begin{bmatrix} -1 & 0 \\ 0 & 1 \end{bmatrix}, \begin{bmatrix} 1 & 0 \\ 0 & -1 \end{bmatrix}, \begin{bmatrix} 1 & 0 \\ 1 & -1 \end{bmatrix}, \begin{bmatrix} -1 & 1 \\ 0 & 1 \end{bmatrix}, \begin{bmatrix} 1 & 0 \\ 1 & -1 \end{bmatrix}.$$

Thus, we have

$$\text{Ad}(\mathbb{E}(y_1))\varphi_1 \text{Ad}(\mathbb{E}(y_2))\varphi_2 \tau = \text{Ad}(\mathbb{E}(y_1)\mathbb{E}(y_2))\varphi_1 \varphi_2 \tau \quad (5.4)$$

$$\text{Ad}(\mathbb{E}(y_2))\varphi_2 \text{Ad}(\mathbb{E}(y_1))\varphi_1 \text{Ad}(\mathbb{E}(y_2))\varphi_2 = \text{Ad}(\mathbb{E}(y_1)\mathbb{E}(q^{-1/2}y_1y_2)\mathbb{E}(y_1))\varphi_2 \varphi_1 \varphi_2. \quad (5.5)$$

Since we have  $\varphi_1 \varphi_2 \tau = \varphi_2 \varphi_1 \varphi_2$ , the equality (5.3) is in fact a consequence of the pentagon identity (1.3)

$$\mathbb{E}(y_1)\mathbb{E}(y_2) = \mathbb{E}(y_2)\mathbb{E}(q^{-1/2}y_1y_2)\mathbb{E}(y_1).$$

**5.3. Action of autoequivalences of the derived category.** Let  $F : \mathcal{D}_{fd}\Gamma \rightarrow \mathcal{D}_{fd}\Gamma$  be a triangle equivalence such that  $F$  is *reachable*, i.e. there is a sequence of (per-)mutations linking the initial cluster collection  $S = (S_1, \dots, S_n)$  to  $FS$ . Thus, the collection  $FS$  still belongs to  $\text{Ccl}$  and of course, so does  $FS'$  for any other cluster collection  $S'$  in  $\text{Ccl}$ . With  $F$ , we will associate a canonical automorphism  $\zeta(F)$  of the functor

$$\text{FG} : \text{Ccl}^{op} \rightarrow \text{Sf}.$$

Indeed, for any cluster collection  $S'$ , we have an isomorphism of quivers  $Q_{FS'} = Q_{S'}$  given by the bijection  $FS'_i \mapsto S'_i$  on the set of vertices. Thus, we have a canonical isomorphism of skew fields

$$\text{FG}(FS') \xrightarrow{\sim} \text{FG}(S').$$

We define  $\zeta(F)(S') : \text{FG}(S') \rightarrow \text{FG}(S')$  to be the composition of this isomorphism with  $\text{FG}(\alpha)$  for any morphism  $\alpha : S' \rightarrow FS'$ . It is immediate from Theorem 5.2, that  $\zeta(F)$  is indeed an automorphism of  $\text{FG}(S')$ , and that  $\zeta$  defines a homomorphism from the group of (isomorphism classes of) reachable autoequivalences of  $\mathcal{D}_{fd}\Gamma$  to the group of automorphisms of the functor  $\text{FG}$ . The following theorem is based on Nagao's ideas [52].

**Theorem 5.4.** *Suppose that the inverse suspension functor  $\Sigma^{-1} : \mathcal{D}_{fd}\Gamma \rightarrow \mathcal{D}_{fd}\Gamma$  is reachable. Then  $(Q, W)$  is Jacobi-finite. If moreover conjecture 3.2 holds for  $(Q, W)$  so that the refined DT-invariant  $\mathbb{E}_{Q, W}$  is well-defined, then it is rational and  $\text{DT}_{Q, W}$  equals  $\zeta(\Sigma^{-1})$ .*

For example, consider the quiver  $Q : 1 \rightarrow 2$ . Then the morphism  $\alpha = \mu_2^+ \mu_1^+$  of (5.1) shows that  $\Sigma^{-1}$  is reachable. Now we use the equality (5.4) and the fact that the composition  $\varphi_1 \varphi_2$  of  $\varphi_1$  with  $\varphi_2$  in (5.4) equals  $\Sigma$  to deduce that, in accordance with the theorem, we have

$$\text{DT}_{Q, W} = \text{Ad}(\mathbb{E}(y_1)\mathbb{E}(y_2)) \circ \Sigma = \text{FG}(\alpha) = \zeta(\Sigma^{-1}).$$

**5.5. The groupoid of cluster tilting sequences.** In view of Theorem 5.2, it is natural to try and ‘factor out’ the braid group action on the category  $\mathcal{D}_{fd}\Gamma$ . This is, in a certain sense, what is achieved by the passage to the cluster category. For simplicity, let us assume that  $(Q, W)$  is Jacobi-finite (the general case can be treated using Plamondon's results [55] [54]). The cluster category  $\mathcal{C}_{Q, W}$  is defined [1] as the triangle quotient  $\text{per}(\Gamma)/\mathcal{D}_{fd}(\Gamma)$ . It is a triangulated category with finite-dimensional morphism spaces which is 2-Calabi-Yau and admits the image  $T$  of  $\Gamma$  as a *cluster-tilting object*, i.e. we have  $\text{Ext}^1(T, T) = 0$  and any object  $X$  such that  $\text{Ext}^1(T, X) = 0$  belongs to the category  $\text{add}(T)$  of direct summands of finite direct sums of copies of  $T$ . For a cluster tilting object  $T'$  the quiver  $Q_{T'}$  is the quiver of the endomorphism algebra of  $T'$ . A *cluster tilting sequence* is a sequence  $(T'_1, \dots, T'_n)$  of pairwise non isomorphic indecomposables of  $\mathcal{C}_{Q, W}$  whose direct sum is a cluster tilting object  $T'$  whose associated quiver  $Q_{T'}$  does not have loops or 2-cycles. There is a canonical mutation operation on all cluster tilting objects, cf. [32]. It yields a partially defined mutation operation on the

cluster-tilting sequences. The *groupoid of cluster-tilting sequences*  $\text{Cl}t = \text{Cl}t_Q$  has as objects the cluster-tilting sequences of  $\mathcal{C}_{Q,W}$  which are reachable from the image  $T = (T_1, \dots, T_n)$  of the sequence of the dg modules  $e_i\Gamma$ ,  $i \in Q_0$ . Its morphisms are defined as formal compositions of mutations and permutations as for the groupoid of cluster collections. The following theorem proved in [43] yields a link between the groupoids  $\text{Cl}t$  and  $\text{Ccl}$ .

**Theorem 5.6** (Keller-Nicolás [43]). *There is a canonical bijection from the set of  $\text{Braid}(Q)$ -orbits of cluster collections in  $\mathcal{D}_{fd}\Gamma$  to the set of cluster tilting sequences in  $\mathcal{C}_{Q,W}$ . It is compatible with mutations and permutations and preserves the quivers.*

The bijection is based on the exact sequence of triangulated categories

$$0 \longrightarrow \mathcal{D}_{fd}\Gamma \longrightarrow \text{per}(\Gamma) \longrightarrow \mathcal{C}_{Q,W} \longrightarrow 0$$

Namely, we define a *silting sequence* to be a sequence  $(P'_1, \dots, P'_n)$  of objects in  $\text{per}(\Gamma)$  such that

- a)  $\text{Hom}(P'_i, \Sigma^p P'_j)$  vanishes for all  $p > 0$ ,
- b) the  $P'_i$  generate  $\text{per}(\Gamma)$  as a triangulated category and
- c) the quiver of the subcategory whose objects are the  $P'_i$  does not have loops nor 2-cycles.

For such a sequence, the subcategory  $\mathcal{A}'$  of  $\mathcal{D}_{fd}\Gamma$  formed by the objects  $X$  such that  $\text{Hom}(P'_i, \Sigma^p X) = 0$  for all  $i$  and all  $p \neq 0$  is the heart  $\mathcal{A}'$  of a non degenerate bounded t-structure whose simples form a cluster collection. The map from silting sequences to cluster collections thus defined is a bijection. We obtain the bijection of the theorem by composing its inverse with the map taking a silting sequence to its image in the cluster category, which one shows to be a cluster tilting sequence using Theorem 2.1 of [1].

Thanks to the theorem, we can define a functor

$$\text{FG} : \text{Cl}t^{op} \rightarrow \text{Sf}$$

by sending a cluster-tilting sequence  $T'$  to the image under  $\text{FG} : \text{Ccl}^{op} \rightarrow \text{Sf}$  of the corresponding cluster collection  $S'$ .

**5.7. Action of autoequivalences of the cluster category.** In analogy with section 5.3, if  $(Q, W)$  is Jacobi-finite, one obtains a homomorphism, still denoted by  $\zeta$ , from the group of reachable autoequivalences of the cluster category  $\mathcal{C}_{Q,W}$  to the automorphism group of the induced functor

$$\text{FG} : \text{Cl}t_Q \rightarrow \text{Sf}.$$

Again, if the suspension functor  $\Sigma^{-1}$  of the cluster category is reachable, we find that  $\zeta(\Sigma^{-1})$  equals  $DT_{Q,W}$ . In particular, if  $\Sigma$  is of finite order  $N$  as an autoequivalence of the cluster category, then the automorphism  $DT_{Q,W}$  of  $\text{Frac}(\mathbb{A}_Q)$  is of

finite order dividing  $N$ . Applications of these ideas include the (quantum version of the) periodicity theorem for the  $Y$ -systems (and  $T$ -systems) associated with pairs of simply laced Dynkin diagrams [38] [42] [39]. Indeed, let  $\vec{\Delta}$  and  $\vec{\Delta}'$  be alternating orientations of simply laced Dynkin diagrams,  $Q$  the triangle product  $\vec{\Delta} \boxtimes \vec{\Delta}'$  and  $W$  the canonical potential on  $Q$  defined in Proposition 5.12 of [39]. Then the cluster category  $\mathcal{C}_{Q,W}$  is equivalent to the cluster category  $\mathcal{C}_{A \otimes_k A'}$  associated [1] with the tensor product of the path algebras  $A = k\vec{\Delta}$  and  $A' = k\vec{\Delta}'$ , by Proposition 5.12 of [loc. cit.]. Let  $\mu_{\boxtimes}$  be the sequence of mutations of  $Q$  defined in (3.6.1) of [loc. cit.]. Then by section 7.4 of [loc. cit.], the Zamolodchikov autoequivalence

$$\mathbf{Za} = \tau^{-1} \otimes \mathbf{1} : \mathcal{C}_{A \otimes_k A'} \rightarrow \mathcal{C}_{A \otimes_k A'} \quad (5.6)$$

is reachable and its image under  $\zeta$  is  $\mu_{\boxtimes}$ . Moreover, if  $h$  and  $h'$  are the Coxeter numbers of  $\Delta$  and  $\Delta'$ , then we have

$$\mathbf{Za}^h = \tau^{-h} \otimes \mathbf{1} = \Sigma^2 \otimes \mathbf{1} = \Sigma^2. \quad (5.7)$$

Since we also have (*cf.* the proof of Theorem 8.4 in [loc. cit.])

$$\mathbf{Za} = \mathbf{1} \otimes \tau, \quad (5.8)$$

we find that

$$\mathbf{Za}^{h'} = \mathbf{1} \otimes \tau^{h'} = \mathbf{1} \otimes \Sigma^{-2} = \Sigma^{-2}. \quad (5.9)$$

Notice that this implies in particular that  $\Sigma^{-2}$  is reachable and yields a sequence of mutations whose composition is the square of the non commutative DT-invariant  $DT_{Q,W}$ . Equation (5.9) confirms equation (8.19) of [12]. In fact, it is not hard to show that  $\Sigma^{-1}$  is also reachable. By combining equations (5.7) and (5.9) we obtain  $\mathbf{Za}^{h+h'} = \mathbf{1}$  and thus  $\mu_{\boxtimes}^{h+h'} = \mathbf{1}$ . By applying the functor  $\text{FG}$  to this last equation, we obtain a statement equivalent to the quantum version of the periodicity for the  $Y$ -system associated with  $(\Delta, \Delta')$ . Notice that in the course of this reasoning, we have also found that

$$\Sigma^{-2} = \mathbf{Za}^{h'} = \mathbf{Za}^{-h}.$$

This implies that the non commutative DT-invariant  $DT_{Q,W}$  is of order dividing

$$2 \frac{h+h'}{\gcd(h, h')},$$

a fact already present in section 8.3.2 of [12].

**5.8. Nearby cluster collections.** Let  $S'$  be a cluster collection and  $\mathcal{A}'$  the associated heart. We define  $\mathcal{A}'$  to be a *nearby heart* and  $S'$  to be a *nearby cluster collection* if there is a torsion pair  $(\mathcal{U}, \mathcal{V})$  in  $\mathcal{A}$  (*cf.* section 1.3) such that  $\mathcal{A}'$  is the full subcategory formed by the objects  $X$  of  $\mathcal{D}_{fd}\Gamma$  such that the object  $H^0(X)$  lies in  $\mathcal{V}$ , the object  $H^1(X)$  in  $\mathcal{U}$  and  $H^p(X)$  vanishes for all  $p \neq 0, 1$ .

**Theorem 5.9** (Nagao [52]). a) *Let  $\mathcal{A}$  be the initial heart and  $\mathcal{A}'$  a nearby heart. Then each simple  $S'_k$  of  $\mathcal{A}'$  either lies in  $\mathcal{A}$  or in  $\Sigma^{-1}\mathcal{A}$ .*



- b) *Each nearby cluster collection  $S'$  is determined by the classes  $[S'_i]$  of its objects in  $K_0(\mathcal{D}_{fd}\Gamma)$ .*

Part a) of the theorem is equivalent to the ‘sign-coherence’ of the classes  $[P'_i] \in K_0(\text{per } \Gamma)$ , where the  $P'_i$  form the silting sequence associated with  $S'$ . The ‘sign-coherence’ is also proved in [55] and, in another language, in [14]. Part b) is an easy consequence.

The following theorem goes back to the insight of Nagao [52]. In this form, it follows [40] from the proof of Theorem 2.18 in [55] and the generalization of theorem 5.6 to quivers with potential which are not necessarily Jacobi-finite, cf. [43].

**Theorem 5.10.** a) *Each cluster collection  $S'$  belongs to the  $\text{Braid}(Q)$ -orbit of a unique nearby cluster collection  $\rho(S')$ .*

- b) *If  $S'$  and  $S''$  are cluster collections related by a mutation, then  $\rho(S')$  and  $\rho(S'')$  are related by a mutation. More precisely, if  $S'' = \mu_k^\pm(S')$  for some sign  $\pm$  and some  $1 \leq k \leq n$ , then  $\rho(S'') = \mu_k^\varepsilon(\rho(S'))$ , where  $\varepsilon = +1$  if the object  $S'_k$  of  $S'$  lies in  $\mathcal{A}$  and  $\varepsilon = -1$  if  $S'_k$  lies in  $\Sigma^{-1}\mathcal{A}$ .*

Clearly, a cluster collection is reachable iff each cluster collection in its  $\text{Braid}(Q)$ -orbit is reachable. Thus, the reachable nearby cluster collections form a system of representatives for the  $\text{Braid}(Q)$ -orbits in  $\text{Ccl}$ . Let  $\text{Ncc}$  denote the full subgroupoid of  $\text{Ccl}$  formed by the reachable nearby cluster collections. Then the projection restricts to a functor

$$\text{Ncc} \longrightarrow \text{Ccl} / \text{Braid}(Q)$$

which is full and yields a bijection between the sets of objects. The map  $S' \mapsto \rho(S')$  yields a (non functorial!) section. We have the following diagram of groupoids and functors

$$\begin{array}{ccc} \text{Ncc} & \xrightarrow{\quad} & \text{Ccl} \\ & \searrow & \downarrow \\ & & \text{Ccl} / \text{Braid}(Q) \longrightarrow \text{Sf}^{op}. \end{array}$$

The resulting functor  $\text{Ncc}^{op} \rightarrow \text{Sf}$  can be refined so as to yield *identities between products of series in  $\widehat{\mathbb{A}}_Q$*  (rather than just in the automorphism group of  $\text{Frac}(\mathbb{A}_Q)$ ): Let  $\mathcal{U} \subset \mathcal{A}$  be a torsion subcategory associated with a reachable nearby cluster heart  $\mathcal{A}'$  (so that an object  $X$  of  $\mathcal{D}_{fd}\Gamma$  belongs to  $\mathcal{A}'$  iff the object  $H^1(X)$  belongs to  $\mathcal{U}$ , the object  $H^0(X)$  belongs to  $\mathcal{U}^\perp$  and  $H^p(X)$  vanishes for all  $p \neq 0$ ). Let  $\alpha : S \rightarrow S'$  be a morphism of  $\text{Ncc}$ , where  $S$  is the initial cluster collection and  $S'$  a cluster collection whose associated heart is  $\mathcal{A}'$ . After permuting the elements of  $S'$  we may assume that no permutations occur in  $\alpha$  so that  $\alpha$  is a composition of mutations of nearby cluster collections

$$S = S^{(0)} \xrightarrow{\mu_{k_1}} S^{(1)} \xrightarrow{\mu_{k_2}} \dots \xrightarrow{\mu_{k_N}} S^{(N)}.$$

For  $1 \leq i \leq N$ , let  $\beta_i$  be the class  $k_i$ -th object of  $S^{(i)}$  in  $K_0(\mathcal{D}_{fd}\Gamma)$ . By theorem 5.9, either  $\beta_i$  belongs to the positive cone determined by  $\mathcal{A}$  or to its opposite. We put  $\varepsilon_i = +1$  in the first case and  $\varepsilon_i = -1$  in the second. Then  $\varepsilon_i\beta_i$  is a positive integer linear combination of the classes  $[S_j]$ . We write  $\mathbb{E}(\varepsilon_i\beta_i)$  for  $\mathbb{E}(y^v)$ , where  $v \in \mathbb{N}^n$  is the vector of the coefficients of the decomposition of  $\varepsilon_i\beta_i$  in the basis given by the  $[S_j]$ . Define the invertible element  $E_{\mathcal{U},\alpha}$  of  $\mathbb{A}_Q$  by

$$\mathbb{E}_{\mathcal{U},\alpha} = \mathbb{E}(\varepsilon_1\beta_1)^{\varepsilon_1} \mathbb{E}(\varepsilon_2\beta_2)^{\varepsilon_2} \cdots \mathbb{E}(\varepsilon_N\beta_N)^{\varepsilon_N}.$$

**Theorem 5.11** ([40]). *The element  $\mathbb{E}_{\mathcal{U},\alpha}$  does not depend on the choice of  $\alpha$ .*

The proof of the theorem is independent of conjecture 3.2. It is based on the work of Nagao [52], Plamondon [55] [54], Derksen-Weyman-Zelevinsky [13] [14], Berenstein-Zelevinsky [7], . . . . We put  $\mathbb{E}_{\mathcal{U}} = \mathbb{E}_{\mathcal{U},\alpha}$  for any  $\alpha$ . Notice that if the cluster heart  $\Sigma^{-1}\mathcal{A}$  is reachable, the corresponding torsion subcategory is  $\mathcal{U} = \mathcal{A}$ .

**Theorem 5.12** ([40]). *Suppose that the ground field equals  $\mathbb{C}$  and that conjecture 3.2 holds for  $(Q, W)$  so that the refined DT-invariant  $\mathbb{E}_{Q,W}$  of (3.1) is well-defined. If the cluster heart  $\Sigma^{-1}\mathcal{A}$  is reachable, then  $\mathbb{E}_{\mathcal{A}}$  equals  $\mathbb{E}_{Q,W}$ .*

**5.13. On the proof of the main theorem.** To prove theorem 5.2, by lemma 4.9, it suffices to show that if  $\alpha : S \rightarrow S'$  is a morphism of Ccl to a reachable nearby cluster collection, then  $\text{FG}(\alpha)$  only depends on  $S'$ . The proof [40] of this fact uses

- 1) the technique of the ‘double torus’ (cf. e.g. [17]) to reduce the statement to a statement about seeds in quantum cluster algebras;
- 2) Berenstein-Zelevinsky’s theorem which states that the exchange graph of the quantum cluster algebra of a quiver is canonically isomorphic to the exchange graph of its cluster algebra (Theorem 6.18 of [7]);
- 3) the expression of the (classical) cluster variables in terms of quiver Grassmannians first obtained in this generality by Derksen-Weyman-Zelevinsky [14], cf. also [52] [55].

Among these three ingredients, the third one is perhaps the deepest. Let us make it explicit: Let  $S'$  be a reachable nearby cluster collection. After permuting its objects, we may assume that there is a sequence of mutations transforming the initial cluster collection  $S$  to the given cluster collection  $S'$ . This sequence determines a vertex  $t$  in the  $n$ -regular tree and thus a cluster  $(X_i(t), 1 \leq i \leq n)$  in the cluster algebra associated with  $Q$ , cf. [22]. Following [52] and [54], we can express the cluster variables  $X_j(t)$  in terms of the cluster collection  $S'$  as follows: Let  $(T'_1, \dots, T'_n)$  be the silting sequence associated with  $S'$  and  $(T_1, \dots, T_n)$  the initial silting sequence. Define the integers  $g_{ij}$ ,  $1 \leq i, j \leq n$ , by the equality

$$[T'_j] = \sum_{i=1}^n g_{ij}[T_i]$$

in  $K_0(\text{per } \Gamma)$ . Then we have

$$X_j(t) = \prod_{i=1}^n x_i^{g_{ij}} \sum_e \chi(\text{Gr}_e(H^1(T'_j))) \prod_{i=1}^n x_i^{\langle S_i, e \rangle},$$

where  $\text{Gr}_e$  is the Grassmannian of submodules of dimension vector  $e$  and  $\chi$  the Euler characteristic (for singular cohomology with rational coefficients of the underlying topological space).

**5.14. The tropical groupoid.** We will exhibit a groupoid defined in purely combinatorial terms which, if the potential  $W$  is generic, is isomorphic to the groupoid of nearby cluster collections (and thus admits a full surjective functor to the groupoid of reachable cluster collections modulo the braid group action and to the groupoid of tilting sequences in the cluster category). Let  $\tilde{Q}$  be the quiver obtained from  $Q$  by adding a new vertex  $i'$  and a new arrow  $i \rightarrow i'$  for each vertex  $i$  of  $Q$ . The new vertices  $i'$  are called *frozen* because we never mutate at them. The *tropical groupoid*  $\text{Trp} = \text{Trp}_Q$  has as objects all the quivers obtained from  $\tilde{Q}$  by mutating at the non frozen vertices  $1, \dots, n$ . Its morphisms are formal compositions of mutations at the non frozen vertices and permutations of these vertices as in the definition of the groupoid of cluster tilting sequences in section 5.7.

We construct a morphism of groupoids  $\text{Ncc} \rightarrow \text{Trp}$  as follows: For a reachable nearby cluster collection  $S'$ , define the quiver  $q(S')$  to have the same vertices as  $\tilde{Q}$ , such that the full subquiver on  $1, \dots, n$  is the Ext-quiver of  $S'$ , there are no arrows between frozen vertices, and for each old vertex  $i$ , the number of arrows from  $i$  to a frozen vertex  $j'$  is the integer  $b_{ij}$  defined by the equality

$$[S'_i] = \sum_{j=1}^n b_{ij} [S_j]$$

in  $K_0(\mathcal{D}_{fd}\Gamma)$ . Here, if  $b_{ij}$  is negative, we draw  $-b_{ij}$  arrows from  $j'$  to  $i$ . From theorem 5.9, we deduce the following corollary.

**Corollary 5.15.** a) *The quiver  $q(S')$  uniquely determines  $S'$ .*

b) *The map  $S' \mapsto q(S')$  underlies a unique isomorphism of groupoids  $\text{Ncc} \xrightarrow{\sim} \text{Trp}$ .*

Now we can give a purely combinatorial version of theorem 5.11: Let  $\mathbf{k} = (k_1, \dots, k_N)$  be a sequence of vertices of  $Q$  (no frozen vertices are allowed to occur). Let  $\mu_{\mathbf{k}}(\tilde{Q})$  be the quiver

$$\mu_{k_N} \mu_{k_{N-1}} \cdots \mu_{k_1}(\tilde{Q}),$$

and, more generally, for each  $1 \leq s \leq N$ , let  $\tilde{Q}(\mathbf{k}, s)$  be the quiver

$$\mu_{k_{s-1}} \mu_{k_{s-2}} \cdots \mu_{k_1}(\tilde{Q}).$$

Let  $B^{\tilde{Q}(\mathbf{k}, s)}$  be the antisymmetric matrix associated with this quiver and let  $\beta_s$  be the vector

$$\beta_s = \sum_{j=1}^n b_{k_s, j'}^{\tilde{Q}(\mathbf{k}, s)} e_j$$

in  $\mathbb{Z}^n$ . We know from theorem 5.9 that either all components of  $\beta_s$  are non negative or all are non positive. We put  $\varepsilon_s = +1$  in the first case and  $\varepsilon_s = -1$  in the second. Now we define

$$\mathbb{E}(\mathbf{k}) = \mathbb{E}(\varepsilon_1 \beta_1)^{\varepsilon_1} \mathbb{E}(\varepsilon_2 \beta_2)^{\varepsilon_2} \cdots \mathbb{E}(\varepsilon_N \beta_N)^{\varepsilon_N}.$$

Let  $\mathbf{k}'$  be another sequence of vertices of  $Q$ .

**Theorem 5.16.** *If there is an isomorphism of quivers*

$$\mu_{\mathbf{k}}(\tilde{Q}) \xrightarrow{\sim} \mu_{\mathbf{k}'}(\tilde{Q})$$

*which is the identity on the frozen vertices  $j'$ ,  $1 \leq j \leq n$ , then we have*

$$\mathbb{E}(\mathbf{k}) = \mathbb{E}(\mathbf{k}')$$

*in  $\hat{\mathbb{A}}_Q$ .*

For example, if we apply the theorem to  $Q : 1 \rightarrow 2$  and the sequences  $\mathbf{k} = (1, 2)$  and  $\mathbf{k}' = (2, 1, 2)$ , cf. figure 5, then all the  $\beta_s$  are positive and we find the pentagon identity (1.3). If we use  $\mathbf{k} = (1, 2, 1)$  and  $\mathbf{k}' = (2, 1)$  instead, then for  $\mathbf{k}$ , the vector  $\beta_3$  is negative and we find the identity

$$\mathbb{E}(y_1)\mathbb{E}(y_2)\mathbb{E}(y_1)^{-1} = \mathbb{E}(y_2)\mathbb{E}(q^{-1/2}y_1y_2),$$

which is of course equivalent to (1.3).

Let  $\tilde{Q}'$  be a quiver of the tropical groupoid  $\text{Trp}_Q$ . Define a non frozen vertex  $i$  of  $\tilde{Q}'$  to be *green* if there are no arrows from frozen vertices to  $i$  and *red* otherwise. Define a sequence  $\mathbf{k}$  of green vertices of  $\tilde{Q}'$  to be *maximal* if all non frozen vertices of  $\mu_{\mathbf{k}}(\tilde{Q}')$  are red. In many cases, the following proposition allows one to construct the refined DT-invariant combinatorially (cf. also section 5.2, page 49 of [24]).

**Proposition 5.17.** *Suppose the  $\tilde{Q}$  admits a maximal green sequence  $\mathbf{k}$ . Then the cluster heart  $\Sigma^{-1}\mathcal{A}$  is reachable and, if the refined DT-invariant  $\mathbb{E}_{Q,W}$  is well-defined, it equals  $\mathbb{E}(\mathbf{k})$ .*

In figure 5, the two maximal green sequences for the quiver  $\vec{A}_2$  are given (green vertices are encircled). Examples of classes of quivers  $Q$  to which the proposition applies include those enumerated in section 4.5. The quiver mutation applet [41] makes it easy to search for maximal green sequences. They exist for acyclic quivers, for square products of acyclic quivers and also for the quivers associated in [5] with each pair consisting of an acyclic quiver and a reduced expression of an element in the Coxeter group associated with its underlying graph. For this case, a maximal green sequence is constructed in section 12 of [27].

## References

- [1] Claire Amiot, *Cluster categories for algebras of global dimension 2 and quivers with potential*, Annales de l'institut Fourier **59** (2009), no. 6, 2525–2590.

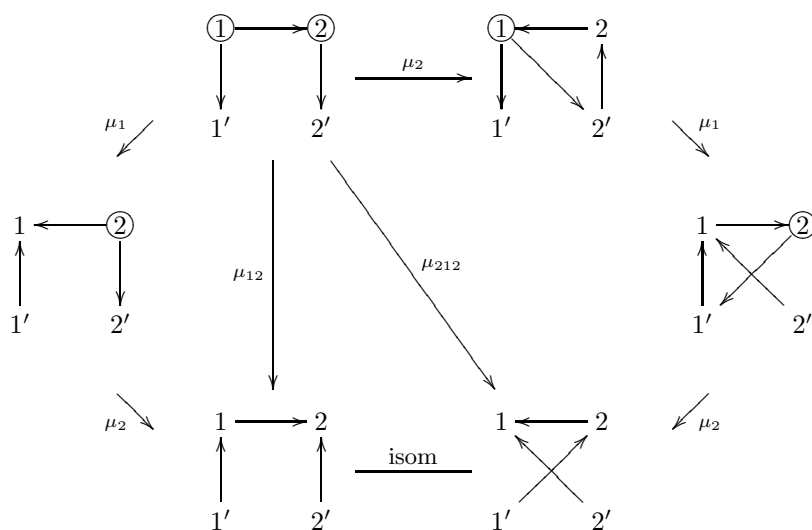

Figure 5. The two maximal green sequences for  $A_2$

- [2] Claire Amiot, Idun Reiten, and Gordana Todorov, *The ubiquity of generalized cluster categories*, *Advances in Mathematics* **226** (2011), no. 4, 3813 – 3849.
- [3] Ibrahim Assem, Daniel Simson, and Andrzej Skowroński, *Elements of the representation theory of associative algebras. Vol. 1*, London Mathematical Society Student Texts, vol. 65, Cambridge University Press, Cambridge, 2006, Techniques of representation theory.
- [4] M. Auslander, I. Reiten, and S. Smalø, *Representation theory of Artin algebras*, Cambridge Studies in Advanced Mathematics, vol. 36, Cambridge University Press, 1995 (English).
- [5] Aslak Bakke Buan, Osamu Iyama, Idun Reiten, and Jeanne Scott, *Cluster structures for 2-Calabi-Yau categories and unipotent groups*, *Compos. Math.* **145** (2009), no. 4, 1035–1079.
- [6] Arkady Berenstein, Sergey Fomin, and Andrei Zelevinsky, *Cluster algebras. III. Upper bounds and double Bruhat cells*, *Duke Math. J.* **126** (2005), no. 1, 1–52.
- [7] Arkady Berenstein and Andrei Zelevinsky, *Quantum cluster algebras*, *Adv. Math.* **195** (2005), no. 2, 405–455.
- [8] Tom Bridgeland, *An introduction to motivic Hall algebras*, arXiv:1002.4372 [math.AG].
- [9] ———, *Stability conditions and Hall algebras*, Talk at the meeting ‘Recent developments in Hall algebras’, Luminy, November 2006.
- [10] ———, *t-structures on some local Calabi-Yau varieties*, *J. Algebra* **289** (2005), no. 2, 453–483.

- [11] Tom Bridgeland and David Stern, *Helices on del Pezzo surfaces and tilting Calabi-Yau algebras*, Adv. Math. **224** (2010), no. 4, 1672–1716.
- [12] Sergio Cecotti, Andrew Neitzke, and Cumrun Vafa, *R-twisting and 4d/2d-Correspondences*, arXiv:10063435 [physics.hep-th].
- [13] Harm Derksen, Jerzy Weyman, and Andrei Zelevinsky, *Quivers with potentials and their representations I: Mutations*, Selecta Mathematica **14** (2008), 59–119.
- [14] ———, *Quivers with potentials and their representations II: Applications to cluster algebras*, J. Amer. Math. Soc. **23** (2010), 749–790.
- [15] L. Faddeev and A. Yu. Volkov, *Abelian current algebra and the Virasoro algebra on the lattice*, Phys. Lett. B **315** (1993), no. 3-4, 311–318.
- [16] L. D. Faddeev and R. M. Kashaev, *Quantum dilogarithm*, Modern Phys. Lett. A **9** (1994), no. 5, 427–434.
- [17] V. V. Fock and A. B. Goncharov, *The quantum dilogarithm and representations of quantum cluster varieties*, Invent. Math. **175** (2009), no. 2, 223–286.
- [18] Vladimir V. Fock and Alexander B. Goncharov, *Cluster ensembles, quantization and the dilogarithm*, Annales scientifiques de l'ENS **42** (2009), no. 6, 865–930.
- [19] Sergey Fomin and Andrei Zelevinsky, *Cluster algebras. I. Foundations*, J. Amer. Math. Soc. **15** (2002), no. 2, 497–529 (electronic).
- [20] ———, *Cluster algebras. II. Finite type classification*, Invent. Math. **154** (2003), no. 1, 63–121.
- [21] ———, *Y-systems and generalized associahedra*, Ann. of Math. (2) **158** (2003), no. 3, 977–1018.
- [22] ———, *Cluster algebras IV: Coefficients*, Compositio Mathematica **143** (2007), 112–164.
- [23] P. Gabriel and A.V. Roiter, *Representations of finite-dimensional algebras*, Encyclopaedia Math. Sci., vol. 73, Springer-Verlag, 1992.
- [24] Davide Gaiotto, Gregory W. Moore, and Andrew Neitzke, *Framed BPS States*, arXiv:1006.0146 [physics.hep-th].
- [25] ———, *Wall-crossing, Hitchin systems, and the WKB approximation*, arXiv:0907.3987 [physics.hep-th].
- [26] ———, *Four-dimensional wall-crossing via three-dimensional field theory*, Comm. Math. Phys. **299** (2010), no. 1, 163–224.
- [27] Christof Geiß, Bernard Leclerc, and Jan Schröer, *Kac-Moody groups and cluster algebras*, arXiv:1001.3545v1 [math.RT].
- [28] ———, *Preprojective algebras and cluster algebras*, Trends in representation theory of algebras and related topics, EMS Ser. Congr. Rep., Eur. Math. Soc., Zürich, 2008, pp. 253–283.
- [29] Victor Ginzburg, *Calabi-Yau algebras*, arXiv:math/0612139v3 [math.AG].
- [30] Dieter Happel, Idun Reiten, and Sverre O. Smalø, *Tilting in abelian categories and quasitilted algebras*, Mem. Amer. Math. Soc. **120** (1996), no. 575, viii+ 88.
- [31] Colin Ingalls and Hugh Thomas, *Noncrossing partitions and representations of quivers*, Compos. Math. **145** (2009), no. 6, 1533–1562.

- [32] Osamu Iyama and Yuji Yoshino, *Mutations in triangulated categories and rigid Cohen-Macaulay modules*, *Inv. Math.* **172** (2008), 117–168.
- [33] Dominic Joyce, *Configurations in abelian categories. I. Basic properties and moduli stacks*, *Adv. Math.* **203** (2006), no. 1, 194–255.
- [34] ———, *Configurations in abelian categories. II. Ringel-Hall algebras*, *Adv. Math.* **210** (2007), no. 2, 635–706.
- [35] ———, *Motivic invariants of Artin stacks and ‘stack functions’*, *Q. J. Math.* **58** (2007), no. 3, 345–392.
- [36] ———, *Configurations in abelian categories. IV. Invariants and changing stability conditions*, *Adv. Math.* **217** (2008), no. 1, 125–204.
- [37] Dominic Joyce and Yinan Song, *A theory of generalized Donaldson-Thomas invariants*, arXiv:0810.5645 [math.AG].
- [38] Bernhard Keller, *Cluster algebras, quiver representations and triangulated categories*, arXiv:0807.1960 [math.RT].
- [39] ———, *The periodicity conjecture for pairs of Dynkin diagrams*, arXiv:1001.1531.
- [40] ———, *Quantum dilogarithm identities from quiver mutations*, in preparation.
- [41] ———, *Quiver mutation in Java*, Java applet available at the author’s home page.
- [42] ———, *Cluster algebras, quiver representations and triangulated categories*, *Triangulated categories* (Thorsten Holm, Peter Jørgensen, and Raphaël Rouquier, eds.), London Mathematical Society Lecture Note Series, vol. 375, Cambridge University Press, 2010, pp. 76–160.
- [43] Bernhard Keller and Pedro Nicolás, *Cluster hearts and cluster tilting objects*, in preparation.
- [44] ———, *Simple dg modules for positive dg algebras*, arXiv:1009.5904 [math.RT].
- [45] Bernhard Keller and Dong Yang, *Derived equivalences from mutations of quivers with potential*, *Advances in Mathematics* **26** (2011), 2118–2168.
- [46] Bernhard Keller, Dong Yang, and Guodong Zhou, *The Hall algebra of a spherical object*, *J. Lond. Math. Soc. (2)* **80** (2009), no. 3, 771–784.
- [47] A. D. King, *Moduli of representations of finite-dimensional algebras*, *Quart. J. Math. Oxford Ser. (2)* **45** (1994), no. 180, 515–530.
- [48] Maxim Kontsevich, *Master class on wall-crossing*, lectures at the Centre for quantum geometry of moduli spaces, Aarhus University, August 2010, available at [qgm.au.dk/calendar/video-recordings](http://qgm.au.dk/calendar/video-recordings).
- [49] ———, *Private communication*, February 2, 2011.
- [50] Maxim Kontsevich and Yan Soibelman, *Cohomological Hall algebra, exponential Hodge structures and motivic Donaldson-Thomas invariants*, arXiv:1006.2706.
- [51] ———, *Stability structures, Donaldson-Thomas invariants and cluster transformations*, arXiv:0811.2435.
- [52] Kentaro Nagao, *Donaldson-Thomas theory and cluster algebras*, arXiv:1002.4884 [math.AG].
- [53] Tomoki Nakanishi, *Periodicities in cluster algebras and dilogarithm identities*, to appear in the Proceedings of the ICRA XIV, Tokyo 2010.

- [54] Pierre-Guy Plamondon, *Cluster algebras via cluster categories with infinite-dimensional morphism spaces*, arXiv:1004.0830 [math.RT], to appear in *Advances*.
- [55] ———, *Cluster characters for cluster categories with infinite-dimensional morphism spaces*, arXiv:1002.4956 [math.RT], to appear in *Compositio*.
- [56] Markus Reineke, *The Harder-Narasimhan system in quantum groups and cohomology of quiver moduli*, *Invent. Math.* **152** (2003), no. 2, 349–368.
- [57] ———, *Poisson automorphisms and quiver moduli*, *J. Inst. Math. Jussieu* **9** (2010), no. 3, 653–667.
- [58] Jeremy Rickard and Raphaël Rouquier, *Stable categories and reconstruction*, arXiv:1008.1976v1 [math.RT].
- [59] C.M. Ringel, *Tame algebras and integral quadratic forms*, *Lecture Notes in Mathematics*, vol. 1099, Springer Verlag, 1984.
- [60] Olivier Schiffmann, *Lectures on Hall algebras*, math.RT/0611617.
- [61] Marcel Paul Schützenberger, *Une interprétation de certaines solutions de l'équation fonctionnelle:  $F(x + y) = F(x)F(y)$* , *C. R. Acad. Sci. Paris* **236** (1953), 352–353.
- [62] Paul Seidel and Richard Thomas, *Braid group actions on derived categories of coherent sheaves*, *Duke Math. J.* **108** (2001), no. 1, 37–108.
- [63] Balázs Szendrői, *Non-commutative Donaldson-Thomas invariants and the conifold*, *Geom. Topol.* **12** (2008), no. 2, 1171–1202.
- [64] Don Zagier, *The dilogarithm function*, *Frontiers in number theory, physics, and geometry. II*, Springer, Berlin, 2007, pp. 3–65.
- [65] Al. B. Zamolodchikov, *On the thermodynamic Bethe ansatz equations for reflectionless ADE scattering theories*, *Phys. Lett. B* **253** (1991), no. 3-4, 391–394.

Bernhard Keller, Université Denis Diderot – Paris 7, Institut universitaire de France,  
 U.F.R. de mathématiques, Institut de mathématiques de Jussieu, U.M.R. 7586 du  
 CNRS, Case 7012, Bâtiment Chevaleret, 75205 Paris, France  
 E-mail: keller@math.jussieu.fr