

Sweeping the **cd**-Index and the Toric h -Vector

Carl W. Lee

Department of Mathematics
University of Kentucky

April 6, 2009, Revised November 1, 2010

Abstract: We derive formulas for the **cd**-index and the toric h -vector of a convex polytope P from a sweeping by a hyperplane. These arise from interpreting the corresponding S -shelling [14] of the dual of P . We describe a partition of the faces of the complete truncation of P to reflect explicitly the nonnegativity of its **cd**-index and what its components are counting. One corollary is a quick way to compute the toric h -vector directly from the **cd**-index that turns out to be an immediate consequence of formulas in [2]. We also propose an “extended toric” h -vector that fully captures the information in the flag h -vector.

1 Introduction

By sweeping a hyperplane across a simple convex d -polytope P , the h -vector, $h(P^*) = (h_0, \dots, h_d)$, of its dual can be computed—the edges in P are oriented in the direction of the sweep and h_i equals the number of vertices of outdegree i . Moreover, the nonempty faces of P can be partitioned to explicitly reflect the formula for the h -vector. For a general convex polytope, in place of the h -vector, one often considers the flag f -vector and flag h -vector as well their encoding into the **cd**-index, and also the toric h -vector (which does not contain the full information of the flag h -vector). In this paper we derive formulas for the **cd**-index and for the toric h -vector of a convex polytope P from a sweeping of P (Theorems 2, 3, 4 and 6). These arise from interpreting the corresponding S -shelling [14] of the dual of P . We describe a partition of the faces of the complete truncation of P to provide an interpretation of what the components of the **cd**-index are counting (Theorem 1 and Corollary 1). One corollary (Theorem 5) is a quick way to compute the toric h -vector directly from the **cd**-index that turns out to be an immediate consequence of formulas in [2]. We also propose an “extended toric” h -vector that fully captures the information in the flag h -vector (Section 4.3).

Refer to [4, 5, 6, 7, 10, 11, 15], for example, for background information on polytopes and their face numbers.

2 The h -Vector

We begin by reviewing some well-known facts about f -vectors of polytopes. For a convex d -dimensional polytope (d -polytope) P let $f_i = f_i(P)$ denote the number of i -faces (i -dimensional faces) of P , $i = -1, \dots, d$. (Note that $f_{-1} = 1$, counting the empty set, and $f_d = 1$, counting P itself.) The vector $f(P) = (f_0, \dots, f_{d-1})$ is the f -vector of P , and $f(P, x)$ is defined to be $\sum_{i=0}^d f_i x^i$. Faces of dimension 0, 1, and $d-1$ are called, respectively, *vertices*, *edges*, and *facets* of P . The set of vertices of P will be denoted $\text{vert}(P)$. A d -polytope is *simplicial* if every face is a simplex. A d -polytope is *simple* if every vertex is contained in exactly d edges. A dual to a simplicial polytope is simple, and vice versa.

Let $P \subset \mathbf{R}^d$ be a simple d -polytope. The h -vector of the dual P^* of P is (h_0, \dots, h_d) where $h(P, x) = f(P, x-1) = \sum_{i=0}^d h_i x^i$. Choose a direction $p \in \mathbf{R}^d$ such that the inner product $p \cdot x$ is different for each vertex v of P . Sweep the hyperplane $H = \{x \in \mathbf{R}^d : p \cdot x = q\}$ across P by letting the parameter q range from $-\infty$ to ∞ . (Recall that if P contains the origin in its interior, then ordering the vertices of P using a sweeping hyperplane corresponds to ordering the facets of the polar dual P^* using a line shelling induced by a line through the origin.) Orient each edge of P in the direction of increasing value of $p \cdot x$.

Each face of P will have a unique minimal vertex with respect to this orientation. To each vertex v associate the set B_v of nonempty faces having v as the minimal vertex, and (with a small abuse of notation) associate the monomial $h_v = x^i$, where i is the outdegree of v . Then $\mathcal{B} = \{B_v : v \in \text{vert}(P)\}$ is a partition of the nonempty faces of P . The faces in B_v contribute $(x+1)^i$ to $f(P, x)$ and so contribute h_v to $h(P, x)$. Therefore $h(P, x) = \sum_v h_v$ and each block B_v contributes a coefficient of 1 to a single monomial.

3 The \mathbf{cd} -Index

Two objects of study that each, in its own way, generalizes the simplicial h -vector, are the \mathbf{cd} -index and the toric h -vector. Stanley [14] introduced the notion of S -shellings to demonstrate the nonnegativity of the \mathbf{cd} -index.

We will consider a sweeping of a polytope P and, motivated by the calculations associated with the S -shelling of its dual, will construct a partition $\mathcal{B}(P)$ of the nonempty faces of the complete truncation of P , such that each block of $\mathcal{B}(P)$ contributes a coefficient of 1 to one word of the \mathbf{cd} -index of P .

3.1 Definitions

Let P be a convex d -polytope. Using the notation $[d-1] = \{0, \dots, d-1\}$, for every subset $S = \{s_1, \dots, s_k\} \subseteq [d-1]$ where $s_1 < \dots < s_k$, define an S -chain to be a chain of faces of P of the form $F_1 \subset \dots \subset F_k$ where F_i is face of P of dimension s_i , $i = 1, \dots, k$. Let $f_S(P)$ be the number of S -chains. The vector $\bar{f}(P) = (f_S(P))_{S \subseteq [d-1]}$ is the *flag f -vector* of P .

Now define

$$h_S = h_S(P) = \sum_{T \subseteq S} (-1)^{|S|-|T|} f_T(P), \quad S \subseteq [d-1]. \quad (1)$$

The vector $\bar{h}(P) = (h_S(P))_{S \subseteq [d-1]}$ is the *flag h -vector* or *extended h -vector* of P , introduced by Stanley [12].

Bayer and Billera showed that the affine span of the set $\{\bar{h}(P) : h \text{ is a convex } d\text{-polytope}\}$ has dimension $F_d - 1$, where F_d is the d th Fibonacci number. Bayer and Klapper [3] proved that the flag h -vector can be encoded into the **cd**-index, which precisely reflects this dimension. Associate with each subset $S \subseteq [d-1]$ the word $w_S = w_0 \cdots w_{d-1}$ in the noncommuting indeterminates **a** and **b**, where $w_i = \mathbf{a}$ if $i \notin S$ and $w_i = \mathbf{b}$ if $i \in S$. The **ab**-index of P is then the polynomial

$$\Psi(P) = \Psi(P, \mathbf{a}, \mathbf{b}) = \sum_{S \subseteq [d-1]} h_S(P) w_S.$$

The existence of the **cd**-index asserts that there is a polynomial in the noncommuting indeterminates **c** and **d**, $\Phi(P) = \Phi(P, \mathbf{c}, \mathbf{d})$, such that setting $\mathbf{c} = \mathbf{a} + \mathbf{b}$ and $\mathbf{d} = \mathbf{ab} + \mathbf{ba}$ we have $\Phi(P, \mathbf{c}, \mathbf{d}) = \Phi(P, \mathbf{a} + \mathbf{b}, \mathbf{ab} + \mathbf{ba}) = \Psi(P, \mathbf{a}, \mathbf{b})$. Note that **c** has degree one, **d** has degree two, and $\Phi(P)$ has degree d . There are F_d **cd**-words of degree d and one of them, \mathbf{c}^d , will always have coefficient 1. Therefore the remaining $F_d - 1$ terms of the **cd**-index capture the dimension of the affine span of the flag f -vectors of d -polytopes.

3.2 Partitioning the Complete Truncation

Given a d -polytope, we will first construct its complete truncation $T(P)$, the faces of which are in bijection with the chains of P . We will partition the faces of $T(P)$ into blocks, with a certain collection of blocks (and corresponding contribution toward $\Phi(P)$) associated with each vertex of P .

Truncate all of the faces of P by first truncating the vertices of P , translating a supporting hyperplane to each vertex a depth ϵ into P and giving each resulting $(d-1)$ -face the label 0. Then continue by truncating the original edges of P at a depth of ϵ^2 and giving each resulting $(d-1)$ -face the label 1, truncating the original 2-faces of P at a depth of ϵ^3 , etc., until finally truncating the original $(d-1)$ -faces of P at a depth of ϵ^d . Here, $\epsilon > 0$ is taken

to be sufficiently small for the sake of subsequent arguments. The resulting simple polytope, $T(P)$, called the *complete truncation* of P , is dual to the complete barycentric subdivision of the dual P^* of P , and its faces are in one-to-one correspondence with the chains of P . In fact, each nonempty face G of $T(P)$ corresponds to an S -chain of P , where $\sigma(G) = S$ is the set of labels of all of the facets of $T(P)$ containing G . The polytope $T(P)$ itself is labeled by the empty set. For the sweeping hyperplane, choose a vector $p \in \mathbf{R}^d$ such that the inner product $p \cdot x$ is different for all vertices occurring at all stages in the truncation process. See the first row of Figure 2 for an example of a pentagon and its truncation.

For each nonempty face G of $T(P)$ of positive dimension $\dim(G)$ let $j = \min\{i : i \notin \sigma(G)\}$ and w be the vertex of G with greatest value of $p \cdot x$. Define the *top face* of G to be the unique face $\tau(G)$ of G of dimension $\dim(G) - 1$ that contains w and has label set $\sigma(G) \cup \{j\}$. Similarly, let w' be the vertex of G with the smallest value of $p \cdot x$, and define the *bottom face* of G to be the unique face $\beta(G)$ of G of dimension $\dim(G) - 1$ that contains w' and has label set $\sigma(G) \cup \{j\}$. See the second row of Figure 2—each polygon depicts a certain face of $T(P)$, together with its top and bottom faces.

For vertex v of P , let Q_v be the $(d - 1)$ -face created when truncating v in P , and $T(Q_v)$ be the complete truncation of Q_v induced by $T(P)$. Define $H_v = \{x \in \mathbf{R}^d : p \cdot x = q_v\}$ to be the hyperplane in the sweeping family that contains v , H_v^+ to be the open halfspace $\{x \in \mathbf{R}^d : p \cdot x > q_v\}$, and H_v^- to be the open halfspace $\{x \in \mathbf{R}^d : p \cdot x < q_v\}$. Faces of $T(Q_v)$ will be called *upper*, *middle*, or *lower* faces according to whether they lie in H_v^+ , intersect H_v , or lie in H_v^- , respectively. Note that if v is the vertex of P minimizing $p \cdot x$ then $T(Q_v)$ has no middle or lower faces, and if v is the vertex of P maximizing $p \cdot x$ then $T(Q_v)$ has no middle or upper faces. Let R_v be the polytope $Q_v \cap H_v$, which has dimension $d - 2$ when it is nonempty. (R_v will be empty if and only if v minimizes or maximizes $p \cdot x$ over P .) Let $T(R_v)$ be the complete truncation of R_v induced by $T(P)$; namely, $T(R_v) = T(Q_v) \cap H_v$. Hence the faces of $T(R_v)$ are precisely the intersections of H_v with the middle faces of $T(Q_v)$. Observe that for a face G of $T(P)$, $0 \in \sigma(G)$ if and only if G is a face of some $T(Q_v)$.

Lemma 1 *For any face G of $T(P)$ such that $0 \notin \sigma(G)$, the top face $\tau(G)$ is a lower face of some $T(Q_v)$, and the bottom face $\beta(G)$ is an upper face of some (other) $T(Q_v)$. Further, for every v , every lower and upper face of $T(Q_v)$ is uniquely obtainable in this way.*

Proof. Suppose $0 \notin \sigma(G)$. Then $\sigma(\tau(G)) = \sigma(G) \cup \{0\}$. Let v be the vertex of P for which $T(Q_v)$ contributes the label $\{0\}$ to $\tau(G)$, and let w be the vertex of G that maximizes $p \cdot x$ over G . Then $p \cdot w < p \cdot v$, and so $\tau(G)$, which is a face of $T(Q_v)$, lies in H_v^- . The analogous argument shows that $\beta(G)$ is an upper face of some $T(Q_v)$. Now let G' be a lower face of some $T(Q_v)$. G' corresponds to an S -chain $F_1 \subset \cdots \subset F_k$ in P , $S = \{s_1, \dots, s_k\}$, where $0 = s_1 < s_2 < \cdots < s_k$ and $F_1 = \{v\}$. Each F_i contributes a facet F'_i to $T(P)$ and G' is the

intersection of these facets. Because G' lies in H_v^- , by convexity we conclude that there is some $F'_i \neq F'_1$ that also lies in H_v^- . Define G to be the unique face of $T(P)$ with label set $\sigma(G) = \sigma(G') \setminus \{0\}$ that contains G' . Then $G = F'_2 \cap \dots \cap F'_k$ lies in H_v^- . Hence the top vertex of G cannot lie above H_v or be associated with any $T_{v'}$ for any higher vertex v' of P , and so must be in G' , confirming that $G' = \tau(G)$. \square

Given the partitions for complete truncations of polytopes of dimension less than d , we will recursively define the partition $\mathcal{B}(P)$ of the faces of $T(P)$. Three properties to be maintained are:

- P1.** Every vertex v of P will contribute an associated (though possibly empty) collection $\mathcal{B}_v(P)$ of blocks to the partition.
- P2.** If $d > 0$ then every face G for which $0 \notin \sigma(G)$ will be placed in the same block as its top face $\tau(G)$.
- P3.** Suppose $d > 0$ and H is any hyperplane in the sweeping family not meeting any $T(Q_v)$. Then for any vertex v of P in H^+ , the faces in the blocks $\mathcal{B}_v(P)$ all lie in H^+ .

Construction of $\mathcal{B}(P)$:

Step 0: If P is a 0-polytope, $T(P)$ is a single vertex v and $\mathcal{B}_v(P)$ contains the single block $\{v\}$. So assume that P has positive dimension.

Step 1: For every face G of $T(P)$ such that $0 \notin \sigma(G)$ create the “pre-block” $\{G, \tau(G), \beta(G)\}$ consisting of G , its top face and its bottom face. At this point, by Lemma 1, every face of $T(P)$ except the middle faces of the various $T(Q_v)$ have been assigned to pre-blocks.

Step 2: For each vertex v and each middle face G of $T(Q_v)$, insert G in the pre-block containing its top face $\tau(G)$, which will be an upper face of $T(Q_v)$. At this point every face of $T(P)$ has been assigned to a pre-block, there is a one-to-one correspondence between upper faces and pre-blocks, and middle faces are in separate pre-blocks.

Step 3: For each vertex v , consider the recursively defined partition $\mathcal{B}(R_v)$ of the faces of $T(R_v)$ (empty if R_v is empty). Let B be a block in this partition. Each face in B corresponds to a certain middle face in $T(Q_v)$. Merge the pre-blocks containing these corresponding middle faces into a block B' . Place B' into $\mathcal{B}_v(P)$.

Step 4: For each vertex v , consider the recursively defined partition $\mathcal{B}(Q_v)$ of the faces of $T(Q_v)$. For each vertex w of Q_v in H_v^+ , let $\mathcal{B}_w(Q_v)$ be the blocks of $\mathcal{B}(Q_v)$ associated with w . Let B be a block in $\mathcal{B}_w(Q_v)$ (if any). By property (P3) the faces in B are

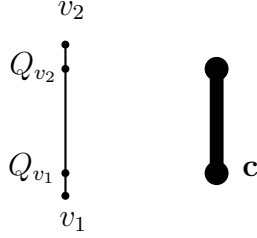

Figure 1: Partitioning the Truncation of a Line Segment

certain upper faces of $T(Q_v)$. Merge the pre-blocks containing these upper faces into a block B' , and place B' into $\mathcal{B}_v(P)$. Once this is carried out for every vertex v of P , all of the pre-blocks have been merged as necessary and $\mathcal{B}(P) = \bigcup_v \mathcal{B}_v(P)$.

To verify that there are no conflicts between the mergings in Step 3 and the mergings in Step 4, we need to make some observations. Let G be a middle face of $T(Q_v)$. Note that $0 \in \sigma(G)$ but $1 \notin \sigma(G)$, because H_v does not contain any vertices of Q_v and the truncations of the edges and other faces of P are made at sufficiently small depths. Now regard Q_v as a polytope in its own right. The label set $\sigma'(G)$ of G with respect to $T(Q_v)$ is obtained from that of $\sigma(G)$ by deleting 0 and reducing the remaining elements of $\sigma(G)$ by one. Thus $0 \notin \sigma'(G)$. By property (P2), within $\mathcal{B}(Q_v)$, G will be placed in the same block as $\tau(G)$. Thus the blocks in $\mathcal{B}(P)$, restricted to the faces in Q_v , will be blocks or subsets of blocks in the partition of the faces of $T(Q_v)$.

It is straightforward from the construction to verify that $\mathcal{B}(P)$ satisfies properties (P1)–(P3).

Theorem 1 $\mathcal{B}(P)$ is a partition of $T(P)$.

Examples

1. The line segment ($d = 1$). See Figure 1. If P is a line segment with two vertices swept in the order v_1, v_2 , then Q_{v_i} is a point and R_{v_i} is empty, $i = 1, 2$. There is only one pre-block, and this becomes the only block in the partition of $T(P)$.
2. The n -gon ($d = 2$). See Figures 2 and 6. If P is an n -gon with vertices swept in the order v_1, \dots, v_n , then Q_{v_i} is a line segment, $i = 1, \dots, n$; R_{v_1} and R_{v_n} are empty; and R_{v_i} is a point, $i = 2, \dots, n - 1$. $Q_{v_1} \subset H_{v_1}^+$, $Q_{v_n} \subset H_{v_n}^-$, and only the top vertex of Q_{v_i} is in $H_{v_i}^+$, $i = 2, \dots, n - 1$. In Figure 2, the first row shows a pentagon and its

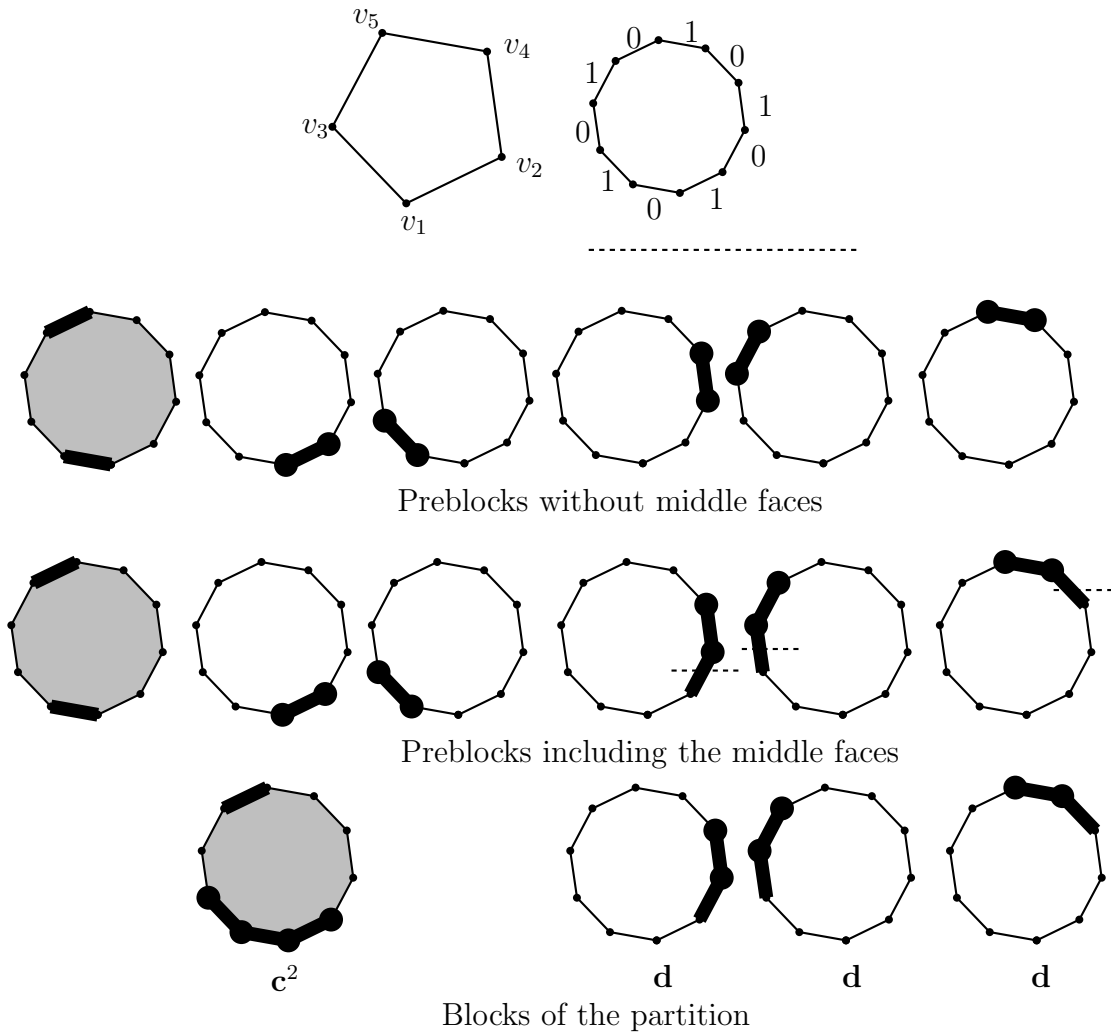

Figure 2: Partitioning a Truncated Pentagon

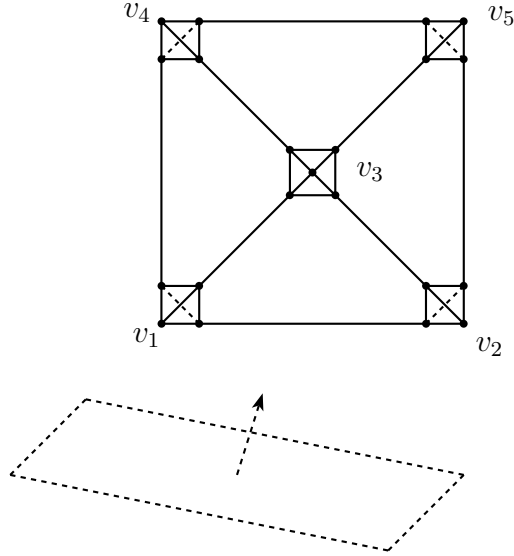

Figure 3: Sweeping a Pyramid (View from Above)

truncation, with the sweeping to occur from bottom to top. The second row shows the result of Step 1, in which the pre-blocks excluding the middle faces have been constructed. The third row shows the result of inserting the three middle faces (one for each of $T(Q_{v_2})$, $T(Q_{v_3})$, and $T(Q_{v_4})$) into the appropriate pre-blocks. The fourth row shows the final partition—the first three pre-blocks in row 3 are merged, because the partition of $T(Q_{v_1})$, a truncated line segment, has a single block consisting of one 1-face and two 0-faces. The other three blocks in row 3 remain unmerged—each is induced by the trivial partition of a single point R_{v_i} , $i = 2, 3, 4$.

3. The square-based pyramid ($d = 3$). Figure 3 shows the square-based pyramid P with truncated vertices. The view is from above, and the vertices are swept in order v_1, \dots, v_5 . Figure 4 is the complete truncation of the pyramid together with the facet labels (the base octagon has label 2). Figure 5 shows the blocks in the partition of $T(P)$.

Blocks (1) and (2) are associated with vertex v_1 of the original pyramid—note that block (1) also includes the truncated base of the pyramid (the outer octagon) as well as the truncated pyramid itself. Block (1) is the result of merging 9 pre-blocks, corre-

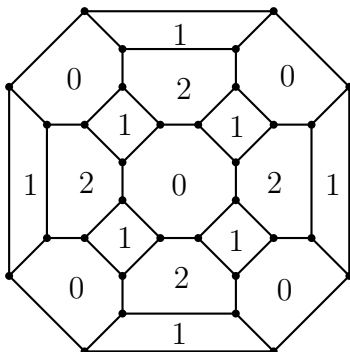

Figure 4: Truncated Pyramid

sponding to the 9 faces in a block of the partition of $T(Q_{v_1})$ (e.g., see the first block in the bottom row of Figure 2). Block (2) is the result of merging 4 pre-blocks, corresponding to the 4 faces in a block of the partition of $T(Q_{v_1})$ (e.g., see the second block in the bottom row of Figure 2). Neither of these pre-blocks include middle faces, because $T(Q_{v_1})$ has none. These two blocks are induced by the partition of the faces of $T(Q_{v_1})$ into two blocks. Blocks (3) and (4) are associated with vertex v_2 . Block (3) is induced by the single block of the partition of $T(Q_{v_2})$ associated with an upper vertex of Q_{v_2} . Block (4) is induced by the partition of the three faces of $T(R_{v_2})$ into a single block. In a similar manner, blocks (5) and (6) are associated with vertex v_3 . Block (7) is associated with vertex v_4 , and is induced by the partition of the three faces of $T(R_{v_4})$ into a single block.

3.3 Sweeping the cd-Index

The partition described in the previous section leads to a recursive method to compute the **cd**-index of P by sweeping. Each vertex of P will be assigned a certain portion $\Phi_v(P)$ of the **cd**-index of P , corresponding to the contribution by $\mathcal{B}_v(P)$. This formula is dual to the results of Stanley [14].

Theorem 2 *For any convex d -polytope P ,*

1. *If $d=0$ then P has one vertex v and $\Phi_v(P) = \Phi(P) = 1$.*

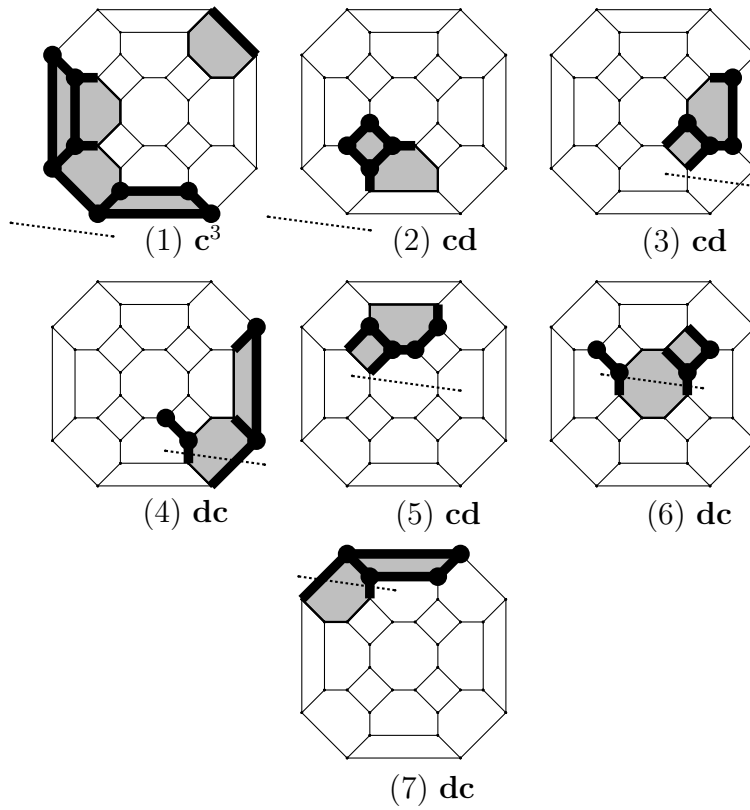

Figure 5: Partitioning a Truncated Pyramid (View from Above)

2. If $d > 0$ then

$$\Phi_v(P) = \mathbf{d}\Phi(R_v) + \sum_{w \in \text{vert}(Q_v) \cap H_v^+} \mathbf{c}\Phi_w(Q_v), \quad v \in \text{vert}(P),$$

and

$$\Phi(P) = \sum_{v \in \text{vert}(P)} \Phi_v(P).$$

Note in particular that the last vertex v to be swept contributes nothing to the \mathbf{cd} -index, since R_v is empty, and there are no vertices w in $\text{vert}(Q_v) \cap H_v^+$.

Proof. We prove by induction that each block in the partition of the faces $T(P)$ has a \mathbf{cd} -index consisting of a single \mathbf{cd} -word, and that the contribution of $\mathcal{B}_v(P)$ to $\Phi(P)$ is taken into account in the formula for $\Phi_v(P)$ stated in the theorem. This is easy to check for $d = 0$: if P is a 0-polytope with vertex v , then $\mathcal{B}(P) = \mathcal{B}_v(P) = \{\{v\}\}$, $\sigma(v) = \emptyset$, and $\Phi(P) = 1$. So assume $d > 0$.

Let G be a middle face as in Step 3 of the partition construction, and let $S = \sigma(G)$. Note as before that $0 \in \sigma(G)$ but $1 \notin \sigma(G)$. Let $S' = S \setminus \{0\}$. The four faces that will be in the same pre-block as G will be:

- G , with label set $\{0\} \cup S'$.
- $\tau(G)$, with label set $\{0, 1\} \cup S'$.
- The face G' for which $\tau(G)$ is the bottom face, with label set $\{1\} \cup S'$.
- $\tau(G')$, with label set $\{0, 1\} \cup S'$.

Observe that the label set \hat{S} of $G \cap H_v$ with respect to the truncation $T(R_v)$ regarded as a $(d-2)$ -polytope in its own right is obtained by subtracting 2 from each label in S' . Therefore the \hat{S} -chain in R_v contributes in P to one $(\{0\} \cup S')$ -chain, one $(\{1\} \cup S')$ -chain, and two $(\{0, 1\} \cup S')$ -chains. Equation (1) then implies that the contribution to $h_{\{0\} \cup S'}$ and $h_{\{1\} \cup S'}$ is each 1. Thus, in terms of \mathbf{ab} -words, if u is the \mathbf{ab} -word for \hat{S} , then this word contributes $\mathbf{bau} + \mathbf{abu} = \mathbf{du}$ to the \mathbf{ab} -index of P . Since such a contribution occurs for each face in a given block B of $\mathcal{B}(R_v)$, then the entire block contributes $\mathbf{d}\Phi(B)$. Therefore $\mathcal{B}(R_v)$ contributes $\mathbf{d}\Phi(R_v)$ to $\Phi(P)$.

Now let G be an upper face as in Step 4, and assume $S = \sigma(G)$. Observe that $0 \in \sigma(G)$, and define $S' = S \setminus \{0\}$. The three faces that will be in the same pre-block as G will be:

- G , with label set $\{0\} \cup S'$.

- The face G' for which G is the bottom face, with label set S' .
- $\tau(G')$, with label set $\{0\} \cup S'$.

Note that the label set \hat{S} of G with respect to the truncation $T(Q_v)$ regarded as a $(d-1)$ -polytope in its own right is obtained by subtracting 1 from each label in S' . Therefore the \hat{S} -chain in Q_v contributes in P to one S' -chain and two $(\{0\} \cup S')$ -chains. Equation (1) then implies that the contribution to $h_{S'}$ and $h_{\{0\} \cup S'}$ is each 1. Thus, in terms of **ab**-words, if u is the **ab**-word for \hat{S} , then this word contributes $\mathbf{au} + \mathbf{bu} = \mathbf{cu}$ to the **ab**-index of P . Since such a contribution occurs for each face in a given block B of $\mathcal{B}(Q_v)$, then the entire block contributes $\mathbf{c}\Phi(B)$. Therefore $\mathcal{B}_w(Q_v)$ contributes $\mathbf{c}\Phi_w(Q_v)$ to $\Phi(P)$. \square

Corollary 1 *Each block in the partition of the nonempty faces of $T(P)$ contributes precisely one **cd**-word to $\Phi(P)$.*

Corollary 2 (Stanley) *For a convex d -polytope P the coefficients of $\Phi(P)$ are nonnegative.*

Examples:

1. The line segment ($d = 1$). See Figure 1.

If P is a line segment with two vertices swept in the order v_1, v_2 , then Q_{v_i} is a point and R_{v_i} is empty, $i = 1, 2$. Q_{v_1} is in $H_{v_1}^+$, $\Phi_{v_1}(P) = \mathbf{c}\Phi(Q_{v_1}) + \mathbf{d}\Phi(R_{v_1}) = \mathbf{c}(1) + \mathbf{d}(0) = \mathbf{c}$; and Q_{v_2} is in $H_{v_2}^-$, $\Phi_{v_2}(P) = \mathbf{c}(0) + \mathbf{d}(0) = 0$. Thus $\Phi(P) = \mathbf{c}$.

2. The n -gon ($d = 2$). See Figure 6.

If P is an n -gon with vertices swept in the order v_1, \dots, v_n , then Q_{v_i} is a line segment, $i = 1, \dots, n$; R_{v_1} and R_{v_n} are empty; and R_{v_i} is a point, $i = 2, \dots, n-1$. $Q_{v_1} \subset H_{v_1}^+$, $Q_{v_n} \subset H_{v_n}^-$, and only the top vertex of Q_{v_i} is in $H_{v_i}^+$, $i = 2, \dots, n-1$. So $\Phi_{v_1}(P) = \mathbf{c}\Phi(Q_{v_1}) + \mathbf{d}\Phi(R_{v_1}) = \mathbf{c}(\mathbf{c}) + \mathbf{d}(0) = \mathbf{c}^2$, $\Phi_{v_n}(P) = \mathbf{c}(0) + \mathbf{d}\Phi(R_{v_n}) = \mathbf{c}(0) + \mathbf{d}(0) = 0$, and $\Phi_{v_i}(P) = \mathbf{c}(0) + \mathbf{d}\Phi(R_{v_i}) = \mathbf{c}(0) + \mathbf{d}(1) = \mathbf{d}$, $i = 2, \dots, n-1$. Thus $\Phi(P) = \mathbf{c}^2 + (n-2)\mathbf{d}$.

3. The octahedron.

If P is the octahedron with vertices swept in the order v_1, \dots, v_6 as indicated in Figure 7, then Q_{v_i} is a square, $i = 1, \dots, 6$; R_{v_1} and R_{v_6} are empty; and R_{v_i} is a line segment, $i = 2, \dots, 5$. All of the vertices of Q_{v_1} are in $H_{v_1}^+$; only the top three vertices of Q_{v_2} are in $H_{v_2}^+$; only the top two vertices of Q_{v_i} are in $H_{v_i}^+$, $i = 3, 4$; only the top vertex of Q_{v_5} is in $H_{v_5}^+$; and none of the vertices of Q_{v_6} are in $H_{v_6}^+$. So $\Phi_{v_1}(P) = \mathbf{c}(\mathbf{c}^2 + 2\mathbf{d}) + \mathbf{d}(0) = \mathbf{c}^3 + 2\mathbf{cd}$, $\Phi_{v_2}(P) = \mathbf{c}(2\mathbf{d}) + \mathbf{d}(\mathbf{c}) = 2\mathbf{cd} + \mathbf{dc}$, $\Phi_{v_3}(P) = \Phi_{v_4}(P) = \mathbf{c}(\mathbf{d}) + \mathbf{d}(\mathbf{c}) = \mathbf{cd} + \mathbf{dc}$, $\Phi_{v_5}(P) = \mathbf{c}(0) + \mathbf{d}(\mathbf{c}) = \mathbf{dc}$, and $\Phi_{v_6}(P) = \mathbf{c}(0) + \mathbf{d}(0) = 0$. Thus $\Phi(P) = \mathbf{c}^3 + 6\mathbf{cd} + 4\mathbf{dc}$ (and we can reverse the letters in each word of $\Phi(P)$ to get the **cd**-index of the cube, $\mathbf{c}^3 + 6\mathbf{dc} + 4\mathbf{cd}$).

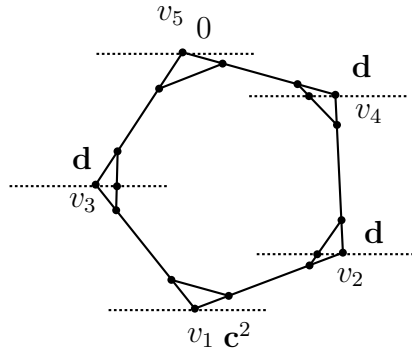

Figure 6: Sweeping the **cd**-Index of a Polygon

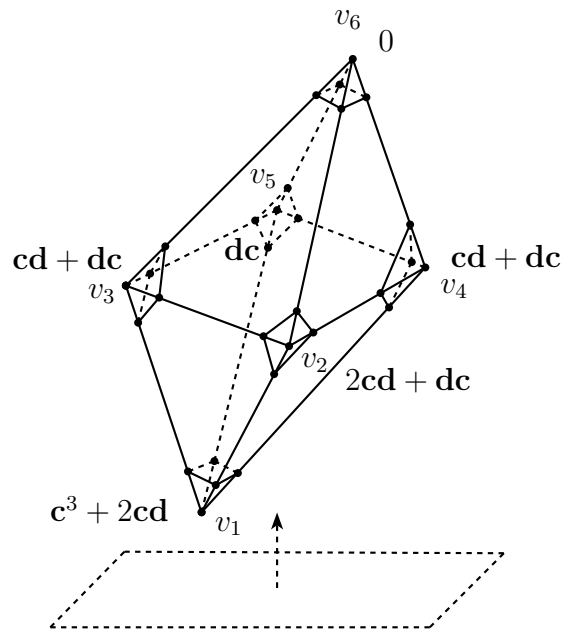

Figure 7: Sweeping the **cd**-Index of an Octahedron

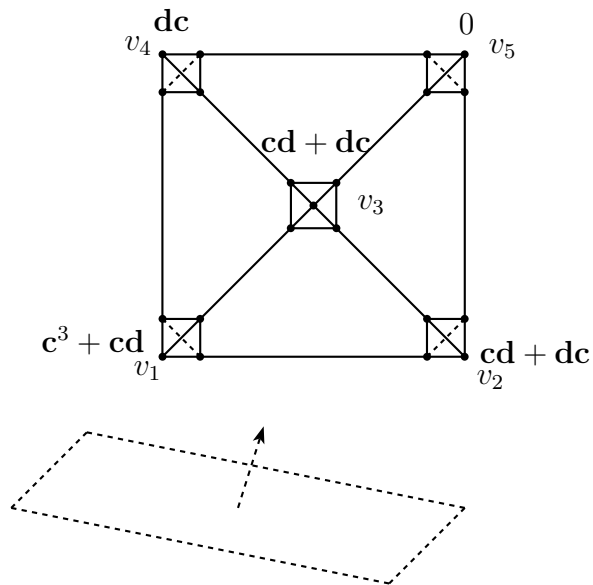

Figure 8: Sweeping the \mathbf{cd} -Index of a Pyramid (View from Above)

4. The square-based pyramid. See Figure 8.

If P is the square-based pyramid with vertices swept in the order v_1, \dots, v_5 as indicated in Figure 8, then Q_{v_i} is a triangle, $i = 1, 2, 4, 5$; Q_{v_3} is a square; R_{v_1} and R_{v_5} are empty; and R_{v_i} is a line segment, $i = 2, 3, 4$. All of the vertices of Q_{v_1} are in $H_{v_1}^+$; only the top two vertices of Q_{v_2} are in $H_{v_2}^+$; only the top two vertices of Q_{v_3} are in $H_{v_3}^+$; only the top vertex of Q_{v_4} is in $H_{v_4}^+$; and none of the vertices of Q_{v_5} are in $H_{v_5}^+$. So $\Phi_{v_1}(P) = \mathbf{c}(\mathbf{c}^2 + \mathbf{d}) + \mathbf{d}(0) = \mathbf{c}^3 + \mathbf{cd}$, $\Phi_{v_2}(P) = \mathbf{c}(\mathbf{d}) + \mathbf{d}(\mathbf{c}) = \mathbf{cd} + \mathbf{dc}$, $\Phi_{v_3}(P) = \mathbf{c}(\mathbf{d}) + \mathbf{d}(\mathbf{c}) = \mathbf{cd} + \mathbf{dc}$, $\Phi_{v_4}(P) = \mathbf{c}(0) + \mathbf{d}(\mathbf{c}) = \mathbf{dc}$, and $\Phi_{v_5}(P) = \mathbf{c}(0) + \mathbf{d}(0) = 0$. Thus $\Phi(P) = \mathbf{c}^3 + 3\mathbf{cd} + 3\mathbf{dc}$.

3.4 A Symmetric Formula

Since the \mathbf{cd} -index is independent of the sweeping used, we can symmetrize the formula in Theorem 2 by taking the average of the results from a sweep and its opposite. In the following theorem the contribution $\Phi_v(P)$ from the sweep is different from that in Theorem 2, even though we are using the same notation. Note in particular that $\Phi_v(P)$ now involves the entire \mathbf{cd} -indices of both Q_v and R_v .

Theorem 3 For any convex d -polytope P ,

1. If $d=0$ then P has one vertex v and $\Phi_v(P) = \Phi(P) = 1$.

2. If $d > 0$ then

$$\Phi_v(P) = \frac{1}{2}[\mathbf{c}\Phi(Q_v) + (2\mathbf{d} - \mathbf{c}^2)\Phi(R_v)], \quad v \in \text{vert}(P),$$

and

$$\Phi(P) = \sum_{v \in \text{vert}(P)} \Phi_v(P).$$

Proof. It is helpful first to extend the computation of the \mathbf{cd} -index to some “near” polytopes. Let R be a $(d-1)$ -polytope and consider the infinite cylinder $R \times \mathbf{R}$ with two points v^+ and v^- adjoined at infinity, one in each direction, each declared to be formally incident to each of the faces of the cylinder. Call this object \overline{R} . Now \overline{R} is not a d -polytope, but its complete truncation $T(\overline{R})$ is: first truncate each of its two vertices by capping the cylinder with a hyperplane at each end, resulting in a prism over R . Then continue by truncating the faces of R . In sweeping the \mathbf{cd} -index of R from v^- toward v^+ , the last vertex v^+ contributes nothing. Now R_{v^-} is empty and Q_{v^-} is combinatorially equivalent to the original R . Therefore by Theorem 2, $\Phi(\overline{R}) = \mathbf{c}\Phi(R)$.

Now let P be a d -polytope with vertices swept in the order v_1, \dots, v_ℓ . For each vertex v define $\vec{\Phi}_v(P)$ to be the contribution by v to $\Phi(P)$ in this sweeping order, and $\overleftarrow{\Phi}_v(P)$ to be the contribution by v to the \mathbf{cd} -index of P in the reverse sweeping direction. Hence

$$\Phi(P) = \sum_{i=1}^{\ell} \vec{\Phi}_{v_i}(P) = \sum_{i=1}^{\ell} \overleftarrow{\Phi}_{v_i}(P).$$

Let H be a hyperplane in the sweeping family positioned so that it separates v_k from v_{k+1} . Define P^+ to be the object obtained by taking $P \cap H^-$, applying a projective transformation that sends the facet $P \cap H$ to infinity, and adjoining a point v^+ at infinity, formally incident to each of the unbounded faces of P^+ . (This latter operation is dual to the “capping” operation arising in S -shellings.) Again P^+ is not a polytope, but its complete truncation $T(P^+)$ is: first truncate v^+ by capping the unbounded faces of P^+ with a single hyperplane. Then continue by truncating the other vertices, and then the other faces. In sweeping the \mathbf{cd} -index of P^+ in the same vertex order as P , the last vertex v^+ contributes nothing, and the remaining vertices contribute to the \mathbf{cd} -index of P^+ in the same way that they contributed to P . Thus

$$\Phi(P^+) = \sum_{i=1}^k \vec{\Phi}_{v_i}(P).$$

In a similar manner, define P^- by taking $P \cap H^+$, applying a projective transformation that sends the facet $P \cap H$ to infinity, and adjoining a point v^- at infinity, formally incident to each of the unbounded faces of P^- . Then

$$\Phi(P^-) = \sum_{i=k+1}^{\ell} \overleftarrow{\Phi}_{v_i}(P).$$

Let $R = P \cap H$. Now as complexes, P^+ and P^- together equal P with an extra copy of \overline{R} , so

$$\Phi(P^+) + \Phi(P^-) = \Phi(P) + \Phi(\overline{R}) = \Phi(P) + \mathbf{c}\Phi(R).$$

Thus

$$\begin{aligned} \sum_{i=k+1}^{\ell} \overrightarrow{\Phi}_{v_i}(P) + \sum_{i=1}^k \overleftarrow{\Phi}_{v_i}(P) &= 2\Phi(P) - \sum_{i=1}^k \overrightarrow{\Phi}_{v_i}(P) - \sum_{i=k+1}^{\ell} \overleftarrow{\Phi}_{v_i}(P) \\ &= 2\Phi(P) - (\Phi(P) + \mathbf{c}\Phi(R)) \\ &= \Phi(P) - \mathbf{c}\Phi(R). \end{aligned}$$

Applying the above formula to Q_v , Theorem 2 then implies

$$\begin{aligned} \Phi_v(P) &= \frac{1}{2}[\Phi_v(P) + \Phi_v(P)] \\ &= \frac{1}{2}[\mathbf{d}\Phi(R_v) + \sum_{w \in \text{vert}(Q_v) \cap H_v^+} \mathbf{c} \overrightarrow{\Phi}_w(Q_v) + \mathbf{d}\Phi(R_v) + \sum_{w \in \text{vert}(Q_v) \cap H_v^-} \mathbf{c} \overleftarrow{\Phi}_w(Q_v)] \\ &= \frac{1}{2}[2\mathbf{d}\Phi(R_v) + \mathbf{c}\Phi(Q_v) - \mathbf{c}^2\Phi(R_v)] \\ &= \frac{1}{2}[\mathbf{c}\Phi(Q_v) + (2\mathbf{d} - \mathbf{c}^2)\Phi(R_v)]. \quad \square \end{aligned}$$

Though it might not be obvious from the formula, note that $\Phi_v(P)$ in the theorem is necessarily nonnegative since it is the sum of two nonnegative quantities.

Examples:

1. The line segment. See Figure 1. $\Phi_{v_i}(P) = \frac{1}{2}[\mathbf{c}\Phi(Q_{v_i}) + (2\mathbf{d} - \mathbf{c}^2)\Phi(R_{v_i})] = \frac{1}{2}[\mathbf{c}(1) + (2\mathbf{d} - \mathbf{c}^2)(0)] = \frac{1}{2}\mathbf{c}$, $i = 1, 2$. Thus $\Phi(P) = \mathbf{c}$.
2. The n -gon. See Figure 6. For $i = 1$ or $i = n$, $\Phi_{v_i}(P) = \frac{1}{2}[\mathbf{c}\Phi(Q_{v_i}) + (2\mathbf{d} - \mathbf{c}^2)\Phi(R_{v_i})] = \frac{1}{2}[\mathbf{c}(\mathbf{c}) + (2\mathbf{d} - \mathbf{c}^2)(0)] = \frac{1}{2}\mathbf{c}^2$; and for $i = 2, \dots, n-1$, $\Phi_{v_i}(P) = \frac{1}{2}[\mathbf{c}\Phi(Q_{v_i}) + (2\mathbf{d} - \mathbf{c}^2)\Phi(R_{v_i})] = \frac{1}{2}[\mathbf{c}^2 + (2\mathbf{d} - \mathbf{c}^2)] = \mathbf{d}$, $i = 2, \dots, n-1$. Thus $\Phi(P) = \mathbf{c}^2 + (n-2)\mathbf{d}$.

3. The octahedron. See Figure 3. $\Phi_{v_i}(P) = \frac{1}{2}[\mathbf{c}(\mathbf{c}^2 + 2\mathbf{d}) + (2\mathbf{d} - \mathbf{c}^2)(0)] = \frac{1}{2}\mathbf{c}^3 + \mathbf{cd}$, $i = 1$ and $i = 6$; and $\Phi_{v_i}(P) = \frac{1}{2}[\mathbf{c}(\mathbf{c}^2 + 2\mathbf{d}) + (2\mathbf{d} - \mathbf{c}^2)(\mathbf{c})] = \mathbf{cd} + \mathbf{dc}$, $i = 2, \dots, 5$. Thus $\Phi(P) = \mathbf{c}^3 + 6\mathbf{cd} + 4\mathbf{dc}$.
4. The square-based pyramid. See Figure 3. $\Phi_{v_i}(P) = \frac{1}{2}[\mathbf{c}(\mathbf{c}^2 + \mathbf{d}) + (2\mathbf{d} - \mathbf{c}^2)(0)] = \frac{1}{2}\mathbf{c}^3 + \frac{1}{2}\mathbf{cd}$, $i = 1$ and $i = 5$; $\Phi_{v_i}(P) = \frac{1}{2}[\mathbf{c}(\mathbf{c}^2 + \mathbf{d}) + (2\mathbf{d} - \mathbf{c}^2)(\mathbf{c})] = \frac{1}{2}\mathbf{cd} + \mathbf{dc}$, $i = 2, 4$; and $\Phi_{v_3}(P) = \frac{1}{2}[\mathbf{c}(\mathbf{c}^2 + 2\mathbf{d}) + (2\mathbf{d} - \mathbf{c}^2)(\mathbf{c})] = \mathbf{cd} + \mathbf{dc}$, Thus $\Phi(P) = \mathbf{c}^3 + 3\mathbf{cd} + 3\mathbf{dc}$.

4 The Toric h -Vector

4.1 Definitions

The *toric h -vector* of (the boundary complex of) a convex d -polytope P , $h(\partial P) = (h_0, \dots, h_d)$, is a linear combination of the components of the flag h -vector that is a non-negative, symmetric, generalization of the h -vector of a simplicial polytope. The component $h_i = h_i(\partial P)$ is the rank of the $(2d - 2i)$ th middle perversity intersection homology group of the associated toric variety in the case that P is rational (has a realization with rational vertices). The g -Theorem [13] implies that the h -vector of a simplicial polytope is unimodal. Karu [8] proved that this is also the case for the toric h -vector of a general polytope P , even when P is not rational. For a summary of some other results on the toric h -vector see [4].

To define the toric h -vector recursively, let $h(\partial P, x) = \sum_{i=0}^d h_i x^{d-i}$ and $g(\partial P, x) = \sum_{i=0}^{\lfloor d/2 \rfloor} g_i x^i$ where $g_0 = g_0(\partial P) = h_0$ and $g_i = g_i(\partial P) = h_i - h_{i-1}$, $i = 1, \dots, \lfloor d/2 \rfloor$. Then

$$g(\emptyset, x) = h(\emptyset, x) = 1,$$

and

$$h(\partial P, x) = \sum_{G \text{ face of } \partial P} g(\partial G, x)(x-1)^{d-1-\dim G}.$$

In the case that P is simplicial the toric h -vector of ∂P agrees with the simplicial h -vector of P .

For example, the toric h -vectors of the boundary complexes of a point, line segment, n -gon, octahedron, and cube are, respectively, (1) , $(1, 1)$, $(1, n-2, 1)$, $(1, 3, 3, 1)$, and $(1, 5, 5, 1)$.

4.2 Sweeping the Toric h -Vector

In Section 2 we recalled that by sweeping any simple polytope P we can compute the h -vector of its dual P^* . Analogously, as we sweep any polytope P , we can compute the toric h -vector of its dual P^* .

Define operators $\mathbf{c} : \mathbf{R}^{d+1} \rightarrow \mathbf{R}^{d+2}$ and $\mathbf{d} : \mathbf{R}^{d+1} \rightarrow \mathbf{R}^{d+3}$ on symmetric vectors (h_0, \dots, h_d) by

$$(h_0, \dots, h_d)\mathbf{c} = \begin{cases} (g_0, g_1, \dots, g_{\lfloor d/2 \rfloor}, g_{\lfloor d/2 \rfloor}, \dots, g_1, g_0) & \text{if } d \text{ is even} \\ (g_0, g_1, \dots, g_{\lfloor d/2 \rfloor}, 0, g_{\lfloor d/2 \rfloor}, \dots, g_1, g_0) & \text{if } d \text{ is odd} \end{cases}$$

and

$$(h_0, \dots, h_d)\mathbf{d} = \begin{cases} (0, \dots, 0, g_{\lfloor d/2 \rfloor}, 0, \dots, 0) & \text{if } d \text{ is even} \\ (0, \dots, 0) & \text{if } d \text{ is odd} \end{cases}$$

where as before $g_0 = h_0$ and $g_i = h_i - h_{i-1}$, $i = 1, \dots, \lfloor d/2 \rfloor$.

Define (with a small abuse of notation) $h_v(\partial P^*)$ to be the contribution by v to the toric h -vector of P^* during the sweeping of P . We now have an analog to Theorem 2:

Theorem 4 *For any convex d -polytope P ,*

1. *If $d = 0$ then P has one vertex v and $h_v(\partial P^*) = h(\partial P^*) = (1)$.*
2. *If $d > 0$ then, regarding \mathbf{c} and \mathbf{d} as operators,*

$$h_v(\partial P^*) = h(\partial(R_v)^*)\mathbf{d} + \sum_{w \in \text{vert}(Q_v) \cap H_v^+} h_w(\partial(Q_v)^*)\mathbf{c}, \quad v \in \text{vert}(P),$$

and

$$h(\partial P^*) = \sum_{v \in \text{vert}(P)} h_v(\partial P^*).$$

Proof. Returning to the definitions of the operators \mathbf{c} and \mathbf{d} , write $h(x) = \sum_{i=0}^d h_i x^i$ and $g(x) = \sum_{i=0}^{\lfloor \frac{d}{2} \rfloor} g_i x^i$. For any polynomial $p(x) = \sum_{i=0}^d p_i x^i$ and nonnegative integer m define $U_{\leq m} p(x) = \sum_{i=0}^m p_i x^i$. Then it is easy to verify that the operators \mathbf{c} and \mathbf{d} can be expressed as

$$\begin{aligned} h(x)\mathbf{c} &= (x-1)h(x) + 2g(x), \\ h(x)\mathbf{d} &= (x-1)g(x) + U_{\leq m}[(1-x)g(x)], \end{aligned}$$

where $m = \lfloor \frac{d+1}{2} \rfloor$. Bayer and Ehrenborg [2] developed explicit formulas for computing the toric h -vector from the \mathbf{cd} -index (Theorem 4.2) in which the contribution for each \mathbf{cd} -word is determined. Their Lemma 7.9 and Proposition 7.10 relate the contribution toward the toric h -vector for \mathbf{cd} -words $u\mathbf{c}$ and $u\mathbf{d}$ with that of \mathbf{cd} -word u , and these correspond precisely to the formulas for the operators \mathbf{c} and \mathbf{d} defined above.

For any \mathbf{cd} -polynomial Φ write Φ^* for the polynomial resulting from reversing all of the words in Φ . Thus for any polytope P , $\Phi(P^*) = \Phi^*(P)$.

By Theorem 2,

$$\Phi(P^*) = \Phi^*(P) = \sum_{v \in \text{vert}(P)} \Phi_v^*(P),$$

and

$$\Phi_v^*(P) = \Phi^*(R_v)\mathbf{d} + \sum_{w \in \text{vert}(Q_v) \cap H_v^+} \Phi_w^*(Q_v)\mathbf{c}, \quad v \in \text{vert}(P).$$

Now use induction and compute the toric h -vectors of both sides. \square

Induction immediately yields a formula to obtain the toric h -vector directly from the \mathbf{cd} -index and to an analog of Theorem 3.

Theorem 5 *Let P be a convex d -polytope. Then, regarding \mathbf{c} and \mathbf{d} as operators, $h(\partial P) = (1)\Phi(P)$.*

Lemma 7.9 and Proposition 7.10 of [2] can be regarded as definitions of operators \mathbf{c} and \mathbf{d} acting upon toric h -vectors, and these results imply Theorem 5 directly.

In the following theorem the contribution $h_v(\partial P^*)$ from the sweep is different from that in Theorem 4, even though we are using the same notation. Note in particular that $h_v(\partial P^*)$ now involves the entire toric h -vectors of both $\partial(Q_v)^*$ and $\partial(R_v)^*$.

Theorem 6 *For any convex d -polytope P ,*

1. *If $d = 0$ then P has one vertex v and $h_v(\partial P^*) = h(\partial P^*) = (1)$.*
2. *If $d > 0$ then, regarding \mathbf{c} and \mathbf{d} as operators,*

$$h_v(\partial P^*) = \frac{1}{2}[h(\partial(Q_v)^*)\mathbf{c} + h(\partial(R_v)^*)(2\mathbf{d} - \mathbf{c}^2)], \quad v \in \text{vert}(P),$$

and

$$h(\partial P^*) = \sum_{v \in \text{vert}(P)} h_v(\partial P^*).$$

Examples

1. *If $d = 0$ and P is a point then $h(\partial P) = (1)\Phi(P) = (1)1 = (1)$.*
2. *If $d = 1$ and P is a line segment then $h(\partial P) = (1)\mathbf{c} = (1, 1)$.*

3. If $d = 2$ and P is an n -gon then

$$\begin{aligned}
h(P) &= (1)\Phi(P) \\
&= (1)(\mathbf{c}^2 + (n-2)\mathbf{d}) \\
&= (1, 1)\mathbf{c} + (n-2)(0, 1, 0) \\
&= (1, 0, 1) + (n-2)(0, 1, 0) \\
&= (1, n-2, 1).
\end{aligned}$$

We can also use Theorem 4; see Figure 6. Vertex v_1 contributes $(1, 1)\mathbf{c} = (1, 0, 1)$ and each remaining vertex except the last contributes $(1)\mathbf{d} = (0, 1, 0)$, yielding $(1, n-2, 1)$.

4. If $d = 3$ and P is the cube then

$$\begin{aligned}
h(\partial P^*) &= \Phi(P)(1) \\
&= (\mathbf{c}^3 + 6\mathbf{c}\mathbf{d} + 4\mathbf{d}\mathbf{c})(1) \\
&= \mathbf{c}^2(1, 1) + 6\mathbf{c}(0, 1, 0) + 4\mathbf{d}(1, 1) \\
&= \mathbf{c}(1, 0, 1) + 6(0, 1, 1, 0) + 4(0, 0, 0, 0) \\
&= (1, -1, -1, 1) + (0, 6, 6, 0) + (0, 0, 0, 0) \\
&= (1, 5, 5, 1).
\end{aligned}$$

We can use Theorem 4 to compute the toric h -vector of a cube P^* from a sweeping of the octahedron P (see Figure 3): $h_{v_1}(\partial P^*) = (1, 2, 1)\mathbf{c} + (0)\mathbf{d} = (1, 1, 1, 1)$, $h_{v_2}(\partial P^*) = (0, 2, 0)\mathbf{c} + (1, 1)\mathbf{d} = (0, 2, 2, 0) + (0, 0, 0, 0) = (0, 2, 2, 0)$, $\Phi_{v_3}(P) = \Phi_{v_4}(P) = (0, 1, 0)\mathbf{c} + (1, 1)\mathbf{d} = (0, 1, 1, 0) + (0, 0, 0, 0) = (0, 1, 1, 0)$, $\Phi_{v_5}(P) = (0)\mathbf{c} + (0, 1, 1, 0)\mathbf{d} = (0, 0, 0, 0)$, and $\Phi_{v_6}(P) = (0)\mathbf{c} + (0)\mathbf{d} = 0$. Thus $h(\partial P^*) = (1, 5, 5, 1)$.

We can also apply Theorem 6 to the octahedron to compute the h -vector of the cube: $h_{v_i}(\partial P^*) = \frac{1}{2}[(1, 2, 1)\mathbf{c} + (0, 0)(2\mathbf{d} - \mathbf{c}^2)] = \frac{1}{2}(1, 1, 1, 1)$, $i = 1$ and $i = 6$; and $h_{v_i}(P^*) = \frac{1}{2}[(1, 2, 1) + \mathbf{c}(1, 1)(2\mathbf{d} - \mathbf{c}^2)] = \frac{1}{2}[(1, 1, 1, 1) + 2(0, 0, 0, 0) - (1, -1, -1, 1)] = \frac{1}{2}(0, 2, 2, 0) = (0, 1, 1, 0)$, $i = 2, \dots, 5$. Thus $h(\partial P^*) = (1, 5, 5, 1)$.

4.3 An “Extended Toric” h -Vector

Even though for a d -polytope P the \mathbf{cd} -index $\Phi(P)$ contains $F_d - 1$ independent pieces of information, the toric h -vector $h(P)$ contains only $\lfloor (d+1)/2 \rfloor$ independent pieces of information. The source of the loss from $\Phi(P)$ to $h(P)$ is evident—the \mathbf{d} operator “erases” information. We can get around this by keeping track of some of the intermediate calculations (those vectors that are about to be acted upon by \mathbf{d}).

Let W be the set of all \mathbf{cd} -words w of degree at most d (including the word 1). Denote by $W^{\mathbf{d}}$ the set of all words in W having \mathbf{d} as the first letter, and include 1 in this set also.

For $w \in W$ let $\Phi^w(P)$ be that portion of $\Phi(P)$ with terms ending in w . Define $h^w(P) = (1)\Phi^w(P)$. Define the “*extended toric*” h -vector of P to be $\hat{h}(P) = (h^w(P) : w \in W^{\mathbf{d}})$.

For example, if P is the octahedron, then $\Phi(P) = \mathbf{c}^3 + 4\mathbf{dc} + 6\mathbf{cd}$. We have:

w	$\Phi^w(P)$	$h^w(P)$
1	$\mathbf{c}^3 + 4\mathbf{dc} + 6\mathbf{cd}$	(1, 3, 3, 1)
\mathbf{c}	$\mathbf{c}^2 + 4\mathbf{d}$	(1, 4, 1)
\mathbf{d}	$6\mathbf{c}$	(6, 6)
\mathbf{c}^2	\mathbf{c}	(1, 1)
\mathbf{dc}	4	(4)
\mathbf{cd}	6	(6)
\mathbf{c}^3	1	(1)

Then $W^{\mathbf{d}} = \{1, \mathbf{d}, \mathbf{dc}\}$ and the extended toric h -vector is $\hat{h}(P) = (h^1(P), h^{\mathbf{d}}(P), h^{\mathbf{dc}}(P)) = ((1, 3, 3, 1), (6, 6), (4))$.

Theorem 7 *For a d -polytope P each $h^w(P)$, $w \in W^{\mathbf{d}}$, is nonnegative, symmetric, and unimodal, and $\hat{h}(P)$ determines $\Phi(P)$.*

To prove this, recall that the toric h -vector of any polytope is nonnegative, symmetric, and unimodal, and by the recursive application of Proposition 2 the operator \mathbf{d} is always multiplied onto the \mathbf{cd} -index of some polytope. Hence each $h^w(P)$, $w \in W^{\mathbf{d}}$, being a sum of h -vectors of such polytopes, is nonnegative, symmetric, and unimodal. To show that $\hat{h}(P)$ determines $\Phi(P)$, observe that

1. Any symmetric vector h can be recovered from hc .
2. For any \mathbf{cd} -word w , $h^{\mathbf{c}w}(P)$ can be recovered from $h^w(P)$ and $h^{\mathbf{d}w}(P)$, since $h^w(P) = (h^{\mathbf{c}w}(P))\mathbf{c} + (h^{\mathbf{d}w}(P))\mathbf{d}$. Therefore, by reverse induction on the degree of w , we can recover all of the vectors $h^w(P)$ from $\hat{h}(P)$.
3. For any \mathbf{cd} -word w of degree d , the coefficient of w in $\Phi(P)$ is precisely the single entry of $h^w(P)$.

This concludes the proof. \square

At this point it remains to be seen whether or not one can get a better understanding of the collection of flag f -vectors of convex d -polytopes from their extended toric h -vectors, or indeed whether one is even justified in giving $\hat{h}(P)$ this name.

5 Comments

Karu [9] described the **cd**-index of a complete fan Δ by beginning with its first barycentric subdivision which, in the case of polytopes, is dual to the complete truncation. He defines operators C and D on functions $f : \Delta^{\leq m} \rightarrow \mathbf{Z}$ on the m -skeleta of the fan Δ . He proves (Proposition 1.2) that if u is a **cd**-word, then the result of applying the corresponding CD operator to the constant function 1 on Δ is the coefficient of u in the **cd**-index of Δ . He then demonstrates how C and D have counterparts in the category of sheaves, and uses this to prove nonnegativity of the **cd**-index of Δ . Karu asks what the coefficients of the **cd**-index count, and so we can now provide one answer of a sort in the case of complete fans associated with polytopes. It is natural to ask what the connection might be between the operators C and D and the toric h -vector.

References

- [1] M. M. BAYER AND L. J. BILLERA, Generalized Dehn-Sommerville relations for polytopes, spheres and Eulerian partially ordered sets, *Invent. Math.* **79** (1985) 143–157.
- [2] M. M. BAYER AND R. EHRENBORG, The toric h -vectors of partially ordered sets, *Trans. Amer. Math. Soc.* **352** (2000) 4515–4531 (electronic).
- [3] M. M. BAYER AND A. KLAPPER, A new index for polytopes, *Discrete Comput. Geom.* **6** (1991) 33–47.
- [4] M. M. BAYER AND C. W. LEE, Combinatorial aspects of convex polytopes, in *Handbook of Convex Geometry, Vol. A, B*, North-Holland, Amsterdam, 1993, pp. 485–534.
- [5] A. BRØNDSTED, *An Introduction to Convex Polytopes*, Springer-Verlag, New York, 1983.
- [6] B. GRÜNBAUM, *Convex Polytopes*, vol. 221 of *Graduate Texts in Mathematics*, Springer-Verlag, New York, Second ed., 2003.
- [7] T. HIBI, *Algebraic Combinatorics on Convex Polytopes*, Carlsaw, Glebe, 1992.
- [8] K. KARU, Hard Lefschetz theorem for nonrational polytopes, *Invent. Math.* **157** (2004) 419–447.
- [9] K. KARU, The cd -index of fans and posets, *Compos. Math.* **142** (2006) 701–718.

- [10] V. KLEE AND P. KLEINSCHMIDT, Convex polytopes and related complexes, in *Handbook of Combinatorics, Vol. 1, 2*, Elsevier, Amsterdam, 1995, pp. 875–917.
- [11] P. MCMULLEN AND G. C. SHEPHARD, *Convex Polytopes and the Upper Bound Conjecture*, Cambridge University Press, London, 1971.
- [12] R. P. STANLEY, Balanced Cohen-Macaulay complexes, *Trans. Amer. Math. Soc.* **249** (1979) 139–157.
- [13] R. P. STANLEY, The number of faces of a simplicial convex polytope, *Adv. in Math.* **35** (1980) 236–238.
- [14] R. P. STANLEY, Flag f -vectors and the cd -index, *Math. Z.* **216** (1994) 483–499.
- [15] G. M. ZIEGLER, *Lectures on Polytopes*, Springer-Verlag, New York, 2007.