

Commutativity of the adiabatic elimination limit of fast oscillatory components and the instantaneous feedback limit in quantum feedback networks

John E. Gough,^{1, a)} Hendra I. Nurdin,^{2, b)} and Sebastian Wildfeuer^{1, c)}

¹⁾*Institute of Mathematics and Physics,
Aberystwyth University,
Aberystwyth, Wales, SY23 3BZ, United Kingdom.*

²⁾*Department of Information Engineering,
Australian National University,
Canberra, ACT 0200, Australia.*

(Dated: 17 October 2018)

We show that, for arbitrary quantum feedback networks consisting of several quantum mechanical components connected by quantum fields, the limit of adiabatic elimination of fast oscillator modes in the components and the limit of instantaneous transmission along internal quantum field connections commute. The underlying technique is to show that both limits involve a Schur complement procedure. The result shows that the frequently used approximations, for instance to eliminate strongly coupled optical cavities, are mathematically consistent.

PACS numbers: 42.50.Ct, 03.65.-w, 02.30.Yy, 07.07.Tw

^{a)}Electronic mail: jug@aber.ac.uk

^{b)}Electronic mail: Hendra.Nurdin@anu.edu.au

^{c)}Electronic mail: sew08@aber.ac.uk

I. INTRODUCTION

Adiabatic elimination is a standard modeling procedure adopted when dealing with systems that have both slow and fast variables. Here one considers the limit in which the fast variables are effectively relaxed to instantaneous equilibrium values, which may in turn depend on external influences, and an effective dynamics may therefore be deduced for the slow variables. The problem becomes more involved when the system is driven by stochastic influences. In quantum optics, fast oscillators driven by quantum input processes may be eliminated from the dynamics using the limiting procedure that they are strongly coupled to the input field processes. The first rigorous account of this limit was given by Gough and van Handel¹¹ and the resulting reduced open dynamics for the slow degrees of freedom were obtained. Extensions of this result to general nonlinear models with a slow-fast time scale separation were given subsequently by Bouten, Silberfarb, and van Handel^{12,13}.

Adiabatic approximation is frequently used to simplify the description of a model. In this paper we aim to investigate the correctness of applying component-wise adiabatic elimination in quantum feedback networks with Markovian components. Here several quantum systems may be connected by passing the output noise from one component in as input to another. In the zero time delay limit we may model the network as a global Markovian system^{4,5}. For a certain class of quantum networks and under certain conditions, we show that the instantaneous feedback limit used to obtain a Markovian quantum feedback network is indeed compatible with the component-wise adiabatic elimination procedure. This is the ideal situation one would require for modeling purposes, however, the conclusion is not immediately obvious when treating individual cases, particularly when the architecture of the network becomes complex. We show that for both limits the form of the coefficients of the quantum stochastic differential equation (QSDE) describing the limit evolution can be formulated as a Schur complement of pre-limit coefficients. Commutativity of the Schur complementation procedure then ensures the commutativity of the adiabatic elimination and instantaneous feedback limits.

In section II we shall review the rigorous results that exist for adiabatic elimination of oscillator components and adapt the results to deal with multiple oscillator elimination (the proof is deferred to the Appendix). We show commutativity of the limits for a simple cascade of components and for components in a non-trivial feedback loop. In section III, we present

the main features of Schur complementation which we shall need, and show that both limits involve Schur complementation procedures. The proof of commutativity of the limits is then established in section IV.

Notation. In this paper we will use the following notation: i denotes $\sqrt{-1}$, $\ker X$ (or $\ker(X)$) denotes the kernel of an operator X , $\text{im } X$ (or $\text{im}(X)$) denotes the image of an operator X . Also, $*$ denotes the operator adjoint. For instance, if $X = (X_1, X_2, \dots, X_m)$ is a row vector of operators X_1, X_2, \dots, X_m on some common Hilbert space then X^* is column vector given by $X^* = (X_1^*, X_2^*, \dots, X_m^*)^T$. Also, $\text{Re } c$ (or $\text{Re}(c)$) and $\text{Im } c$ (or $\text{Im}(c)$) denote the real and imaginary parts of a complex number c , respectively.

II. MODELS IN QUANTUM OPTICS

A. Quantum Input Components

The standard motivation for quantum stochastic evolutions in physical models has been via traveling quantum fields interacting in a Markovian fashion with a given quantum mechanical system¹. The fields may be described by idealized annihilation and creation operators $b_j(t)$ and $b_j(t)^*$ respectively, for $j = 1, \dots, n$, assumed to satisfy singular commutation relations

$$[b_j(t), b_k(s)^*] = \delta_{jk} \delta(t - s).$$

These are sometimes referred to as quantum input processes. From these we may define regularized operators

$$B_j(t)^* = \int_0^t b_j(s)^* ds, \quad B_k(t) = \int_0^t b_k(s) ds, \quad \Lambda_{jk}(t) = \int_0^t b_j(s)^* b_k(s) ds.$$

The older, mathematically rigorous approach is that of Hudson and Parthasarathy which realizes the open Markov dynamics of a system with Hilbert space \mathfrak{h} through a dilation to a *unitary* evolution on a larger space $\mathfrak{h} \otimes \mathfrak{F}$. Specifically \mathfrak{F} is Bose Fock space over $\mathfrak{K} \otimes L^2[0, \infty)$ where $\mathfrak{K} = \mathbb{C}^n$ is the colour, or multiplicity, space of the quantum inputs. The processes $B_j(\cdot), B_k(\cdot)^*, \Lambda_{jk}(\cdot)$ are then realized as concrete creation, annihilation and second quantization operators on \mathfrak{F} .

We shall now work in the category of such models: each element of the category will be an open quantum system modeling a quantum device. A single component with intrinsic

Hilbert space \mathfrak{h} is modeled as an open quantum system with external driving space \mathfrak{F} - the Bose Fock space over a one-particle space $\mathfrak{K} \otimes L^2(\mathbb{R}_+)$. As above, \mathfrak{K} is the multiplicity space of the Bose noise field, and we shall restrict to finite multiplicity for each component ($\mathfrak{K} \equiv \mathbb{C}^n$ for some multiplicity n). Taking $\{e_j\}_{j=1}^n$ to be a fixed orthonormal basis in \mathfrak{K} , we realize $B_j(t)$ as the annihilation operator $B(e_j \otimes 1_{[0,t]})$ on \mathfrak{F} , with $B_j(t)^*$ the creator. The process $\Lambda_{jk}(t)$ is then the differential second quantization of the one-particle operator $|e_j\rangle \langle e_k| \otimes \tilde{1}_{[0,t]}$ on $\mathfrak{K} \otimes L^2(\mathbb{R}_+)$ where $\tilde{1}_{[0,t]}$ denotes the operation of multiplication by $1_{[0,t]}$. We remark that we have the continuous tensor product decomposition

$$\mathfrak{F} \cong \mathfrak{F}_{[t]} \otimes \mathfrak{F}_t$$

for each $t > 0$, where $\mathfrak{F}_{[t]}$ is the past noise space (Fock space over $\mathfrak{K} \otimes L^2[0, t]$) and \mathfrak{F}_t is the future noise space (Fock space over $\mathfrak{K} \otimes L^2[t, \infty)$). A process $X(\cdot)$ on $\mathfrak{h} \otimes \mathfrak{F}$ is then said to be adapted if for each $t > 0$, $X(t)$ acts trivially on the future factor \mathfrak{F}_t .

The Hudson-Parthasarathy theory of quantum stochastic processes^{2,3} gives a non-commutative generalization of Itô's stochastic integral calculus. With differentials $dB_j(t)$, $dB_k^*(t)$, $d\Lambda_{jk}(t)$ understood as being Itô increment^{2,3} (i.e., they are "forward looking", $dX(t) = X(t + dt) - X(t)$ where X can be any of B_j, B_k^*, Λ_{jk}), we obtain the following quantum Itô table^{2,3} for second-order products of the quantum Itô differentials (omitting the dependence on t for brevity)

\times	dB_j	$d\Lambda_{jk}$	dB_k^*	dt
dB_l	0	$\delta_{lj} dB_k$	$\delta_{lk} dt$	0
$d\Lambda_{lm}$	0	$\delta_{mj} d\Lambda_{lk}$	$\delta_{mk} dB_l^*$	0
dB_m^*	0	0	0	0
dt	0	0	0	0

The most general form of a unitary adapted process $U(\cdot)$ on $\mathfrak{h} \otimes \mathfrak{F}$, with time-independent coefficients, will occur as the solution of a quantum stochastic differential equation (QSDE) of the form (adopting a summation convention)

$$dU(t) = \{K \otimes dt - L_j^* S_{jk} \otimes dB_k(t) + L_j \otimes dB_j(t)^* + (S_{jk} - \delta_{jk}) \otimes d\Lambda_{jk}(t)\} U(t), \quad (1)$$

with $U(0) = I$, and where the damping term is

$$K = -\frac{1}{2} L_j^* L_j - iH. \quad (2)$$

We set

$$L = \begin{bmatrix} L_1 \\ \vdots \\ L_n \end{bmatrix}, \quad S = \begin{bmatrix} S_{11} & \cdots & S_{1n} \\ \vdots & \ddots & \vdots \\ S_{n1} & \cdots & S_{nn} \end{bmatrix}.$$

We are required to take $S = [S_{jk}] \in \mathcal{B}(\mathfrak{h} \otimes \mathfrak{K})$ to be unitary and H to be self-adjoint. The operators L_j and H are assumed to have a common dense domain in \mathfrak{h} , which holds in particular when these operators are bounded. In the case that they are unbounded, they will be of a particular form which will be given in (10).

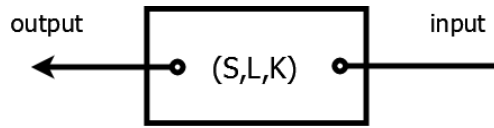

FIG. 1. Single component

From our point of view the category of all possible components is parameterized by \mathfrak{h}, n and the possible triples (S, L, K) as above. It is convenient to collect all the coefficients in the QSDE (1) into a single operator $\mathbf{G} \in \mathcal{B}(\mathfrak{H})$ where

$$\mathfrak{H} = \mathfrak{h} \otimes (\mathbb{C} \oplus \mathfrak{K}). \quad (3)$$

With respect to the decomposition $\mathbb{C} \oplus \mathfrak{K}$ we specifically define \mathbf{G} to be

$$\mathbf{G} = \begin{bmatrix} K & -L^*S \\ L & S - I \end{bmatrix}. \quad (4)$$

In this representation, \mathbf{G} appears as a $(1 + n)$ -dimensional square matrix with entries in $\mathcal{B}(\mathfrak{h})$.

In Fig. 1 we sketch the open system as an input-output device specified by the triple of operators (S, L, K) . The output fields is defined to be the canonical processes

$$B_j^{\text{out}}(t) = U(t)^*[I \otimes B_j(t)]U(t). \quad (5)$$

B. Systems in Series

Let us consider a pair of systems (S_j, L_j, K_j) , $j = 1, 2$, connected in series as shown in Fig. 2. (Note that we technically do not require the observables of the two systems to commute!).

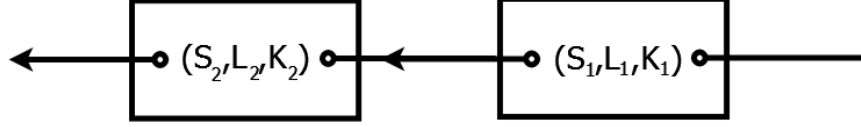

FIG. 2. Systems in series

In the instantaneous feedforward limit, the pair can be viewed as the single system shown in Fig. 3 with overall parameters⁵

$$(S_{\text{ser}}, L_{\text{ser}}, K_{\text{ser}}) = (S_2, L_2, K_2) \triangleleft (S_1, L_1, K_1) \quad (6)$$

where the series product \triangleleft is the associative (though non-commutative) product given by the explicit identification

$$S_{\text{ser}} = S_2 S_1, \quad (7)$$

$$L_{\text{ser}} = L_2 + S_2 L_1, \quad (8)$$

$$K_{\text{ser}} = K_1 + K_2 - L_2^* S_2 L_1. \quad (9)$$

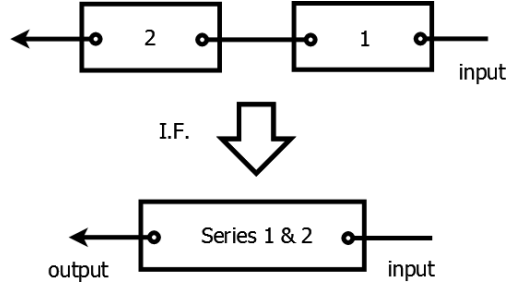

FIG. 3. Systems in series: the upper setup describes two systems connected in series with a time lag $\tau > 0$ in the interconnection from system 1 to 2. In the instantaneous feedforward (I.F.) limit we consider $\tau \rightarrow 0$ in which case we obtain an effective single component model again.

Note that if H_j ($j = 1, 2$) are the Hamiltonians of the separate systems then the damping operators are $K_j = -\frac{1}{2}L_j^*L_j - iH_j$ and the effective Hamiltonian in series is then given by

$$H_{\text{ser}} = H_1 + H_2 + \text{Im}(L_2^* S_2 L_1).$$

C. Adiabatic Elimination of Oscillators

We suppose that the system consists of local oscillators having Hilbert space $\mathfrak{h}_{\text{osc}}$ and that the remaining degrees of freedom live on an auxiliary space $\hat{\mathfrak{h}}$. The overall Hilbert

space of the system is then $\hat{\mathfrak{h}} \otimes \mathfrak{h}_{\text{osc}}$ and we consider an open model described by the triple of operators

$$\begin{aligned} S(k) &= S \otimes I, \\ L(k) &= k \sum_j C_j \otimes a_j + G \otimes I, \\ K(k) &= k^2 \sum_{jl} A_{jl} \otimes a_j^* a_l + k \sum_j Z_j \otimes a_j^* + k \sum_j X_j \otimes a_j + R \otimes I, \end{aligned} \quad (10)$$

where k is a positive scaling parameter and $S, C_j, G, A_{jl}, X_j, Z_j, R$ are bounded operators on $\hat{\mathfrak{h}}$ with $A = [A_{jl}]$ boundedly invertible. Here a_j is the annihilator corresponding to the j -th local oscillator, say with $j = 1, \dots, m$.

As $k \rightarrow \infty$ the oscillators become increasingly strongly coupled to the driving noise field and in this limit we would like to consider them as being permanently relaxed to their joint ground state. The oscillators are then the fast degrees of freedom of the system, with the auxiliary space $\hat{\mathfrak{h}}$ describing the slow degrees. In the adiabatic elimination $k \rightarrow \infty$ we desire a reduced description of an open system involving the operators of $\hat{\mathfrak{h}}$ only, with the fast oscillators being eliminated, as illustrated in Fig. 4. The ground state for the ensemble of m oscillators will be denoted by $|0\rangle_{\text{osc}}$.

Define X to be the *row* vector of operators $X = (X_1, X_2, \dots, X_m)$ and Z to be the *column* vector of operators $Z = (Z_1, Z_2, \dots, Z_m)^T$. Also, we say that a matrix $M = [M_{jl}]_{j,l=1,\dots,m}$, with M_{jl} bounded operators on $\hat{\mathfrak{h}}$, is *strictly Hurwitz stable* if $\text{Re}\langle \phi, M\phi \rangle < 0$ for all $0 \neq \phi \in \hat{\mathfrak{h}} \otimes \mathbb{C}^m$. Then we say that an open Markov quantum system with parameters of the form (10) is strictly Hurwitz stable if the matrix $[A_{jl}]$ is strictly Hurwitz stable. We first have the following result:

Theorem 1 *Let $U(\cdot, k)$ be the unitary adapted evolution associated with the triple $(S(k), L(k), K(k))$ appearing in (10), and define the slow space as $\mathfrak{h}_s = \hat{\mathfrak{h}} \otimes \{\mathbb{C}|0\rangle_{\text{osc}}\}$. If the operator $Y = \sum_{jl} A_{jl} \otimes a_j^* a_l$ has kernel space equal to the slow space, then we have the limit*

$$\lim_{k \rightarrow \infty} \sup_{0 \leq t \leq T} \left\| U(t, k)\Phi - \hat{U}(t)\Phi \right\| = 0,$$

for all $T > 0$ and $\Phi \in \mathfrak{h}_s \otimes \mathfrak{F}$, where $\hat{U}(\cdot)$ is the unitary evolution associated with the triple

$\hat{S} \otimes |0\rangle\langle 0|_{\text{osc}}, \hat{L} \otimes |0\rangle\langle 0|_{\text{osc}}, \hat{K} \otimes |0\rangle\langle 0|_{\text{osc}}$ and

$$\begin{aligned}\hat{S} &= (I + CA^{-1}C^*)S, \\ \hat{L} &= G - CA^{-1}Z, \\ \hat{K} &= R - XA^{-1}Z.\end{aligned}\tag{11}$$

Remark 2 For ease of notation, we will drop the factor “ $\otimes |0\rangle\langle 0|_{\text{osc}}$ ” as it is obvious that in the limit we are always relaxed into the fast oscillator ground states. Therefore we can simply think of the limit QSDE as having initial space $\hat{\mathfrak{h}}$ and coefficients $(\hat{S}, \hat{L}, \hat{K})$.

Remark 3 A sufficient, though not necessary, condition for the kernel space of Y to equal the slow space is that the matrix A be strictly Hurwitz, see Lemma 15.

The result is a generalization of what has been established for the single mode case¹¹ where the main result is stated for weak convergence of the unitaries, but this automatically extends to the strong convergence above. There the techniques were based on a quantum central limit theorem¹⁴ which have been shown to extend to the multimode situation¹⁵. We shall give a proof the theorem in the Appendix, exploiting the theory of singular perturbation of QSDEs developed by Bouten, van Handel, and Silberfarb¹³.

In the following, we shall drop the tensor product symbol for notational convenience. Furthermore we shall introduce the vectorial multi-mode notation

$$a = \begin{bmatrix} a_1 \\ \vdots \\ a_m \end{bmatrix}, a^* = [a_1^*, \dots, a_m^*].$$

We therefore write simply

$$S(k) = S, L(k) = kCa + G, K(k) = k^2a^*Aa + ka^*Z + kXa + R.$$

If we take the Hamiltonian to be

$$H(k) = k^2a^*\Omega a + ka^*\Gamma + k\Gamma^*a + \Theta$$

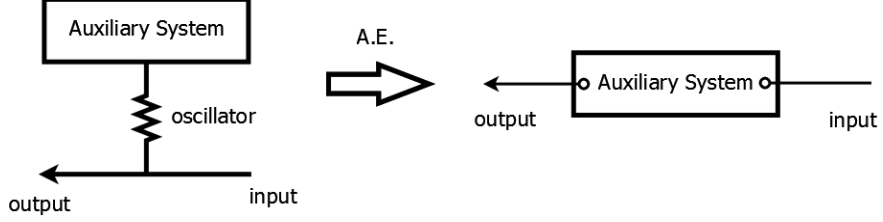

FIG. 4. The setup on the left shows a system of an oscillator and auxiliary component with the oscillator coupled to a quantum field input. In the limit where the coupling of the oscillator becomes infinitely strong, we may adiabatically eliminate the oscillator to obtain an input acting directly on the auxiliary component. This is sketched in the setup on the right.

then

$$\begin{aligned}
 A &= -\frac{1}{2}C^*C - i\Omega, \\
 Z &= -\frac{1}{2}C^*G - i\Gamma, \\
 X &= -\frac{1}{2}G^*C - i\Gamma^*, \\
 R &= -\frac{1}{2}G^*G - i\Theta.
 \end{aligned}$$

In particular we note the identities

$$\begin{aligned}
 A + A^* &= -C^*C, \\
 X + Z^* &= -G^*C, \\
 R + R^* &= -G^*G.
 \end{aligned} \tag{12}$$

We present a naïve derivation of the limit form appearing in Theorem 1, with the proof presented in the Appendix. In the interaction picture we have the quantum Langevin equation

$$\begin{aligned}
 \dot{a} &= \frac{1}{2}L(k)^*[a, L(k)] + \frac{1}{2}L(k)^*[a, L(k)] - i[a, H(k)] - [L(k)^*S, a]b_{\text{in}} \\
 &= -k^2\left(\frac{1}{2}C^*C + i\Omega\right)a + k\left(-\frac{1}{2}C^*G - i\Gamma\right) - kC^*Sb_{\text{in}},
 \end{aligned}$$

where b_{in} is an input quantum process satisfying $[b_{\text{in}}(t), b_{\text{in}}(s)^*] = \delta(t - s)$. Likewise the input-output relations are

$$b_{\text{out}} = Sb_{\text{in}} + L(k) = Sb_{\text{in}} + (kCa + G),$$

where b_{out} is the output quantum white noise field.

We note that we may rewrite the Langevin equation as $\frac{1}{k}\dot{a} = -kAa + Z - C^*Sb_{\text{in}}$ and one argues that as $k \rightarrow \infty$ the left hand side vanishes, so that the right hand side may be rearranged as

$$ka \approx A^{-1}(C^*Sb_{\text{in}} - Z).$$

The common interpretation of this is that the (scaled) oscillator mode becomes “slaved” to the input field: usually this argument is given with k fixed to unity and while clearly mathematically problematic nevertheless, rather miraculously, yields the correct answer. Making this substitution in the output relations, we reasonably expect that

$$\begin{aligned} b_{\text{out}} &= (I + CA^{-1}C^*)Sb_{\text{in}} + (G - CA^{-1}Z) \\ &\equiv \hat{S}b_{\text{in}} + \hat{L}. \end{aligned}$$

This justifies the form of \hat{S} and \hat{L} . The form of \hat{K} may be deduced by substituting $ka \approx A^{-1}(C^*Sb_{\text{in}} - Z)$, and the conjugate relation, into the Langevin equation for any operator acting nontrivially only on the space $\hat{\mathfrak{h}}$. (There is a potential operator ordering ambiguity here, and the appropriate choice is to substitute ka and ka^* in Wick ordered form!)

D. Adiabatic Elimination and Systems in Series

The aim of this section is to determine whether the limits of adiabatic elimination and instantaneous feedforward do in fact commute, as illustrated in Fig. 5. While this is often assumed in quantum optics models, it is certainly far from obvious. At this stage, however, we are able to reduce the question to a direct computation.

Let us represent the local oscillators a_1 and a_2 in a combined manner as

$$a = \begin{bmatrix} a_1 \\ a_2 \end{bmatrix}.$$

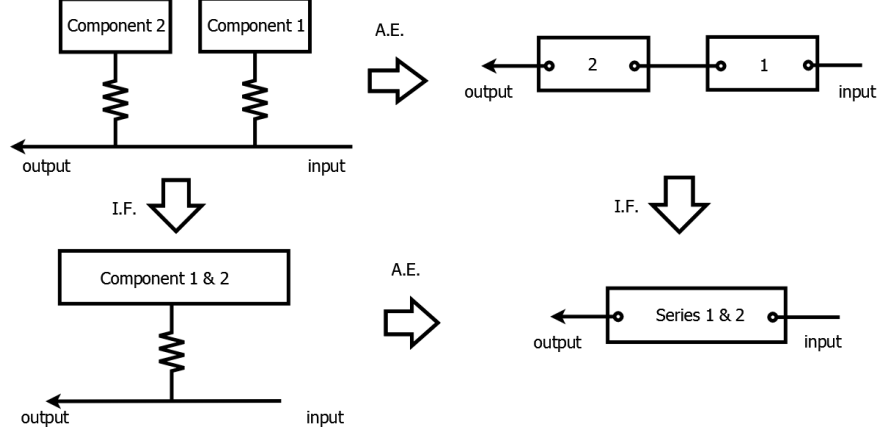

FIG. 5. The picture illustrates the main result that we which to prove here, namely that the adiabatic elimination (A.E.) and the instantaneous feedforward (I.F.) limits can be interchanged.

Then the first system is to be represented as $(S_1(k), L_1(k), K_1(k))$ where

$$\begin{aligned}
 S_1(k) &= S_1, \\
 L_1(k) &= kC_1a_1 + G_1 \equiv k[C_1, 0]a + G_1, \\
 K_1(k) &= k^2a_1^*A_1a_1 + ka_1^*Z_1 + kXa_1 + R_1 \\
 &\equiv k^2a^* \begin{bmatrix} A_1 & 0 \\ 0 & 0 \end{bmatrix} a + ka^* \begin{bmatrix} Z_1 \\ 0 \end{bmatrix} + k[X_1, 0]a + R_1.
 \end{aligned}$$

Likewise, the second system is then represented as

$$\begin{aligned}
 S_2(k) &= S_2, \\
 L_2(k) &\equiv k[0, C_2]a + G_2, \\
 K_2(k) &\equiv k^2a^* \begin{bmatrix} 0 & 0 \\ 0 & A_2 \end{bmatrix} a + ka^* \begin{bmatrix} 0 \\ Z_2 \end{bmatrix} + k[0, X_2]a + R_2.
 \end{aligned}$$

1. *Adiabatic Elimination followed by Instantaneous Feedforward*

If we perform the adiabatic elimination first then we arrive at the two systems ($j = 1, 2$)

$$\begin{aligned}
 \hat{S}_j &= (I + C_jA_j^{-1}C_j^*)S_j \\
 \hat{L}_j &= G_j - C_jA_j^{-1}Z_j, \\
 \hat{K}_j &= R_j - X_jA_j^{-1}Z_j.
 \end{aligned}$$

The instantaneous feedforward limit is then given by the series product

$$\begin{aligned}
S &= \hat{S}_2 \hat{S}_1, \\
L &= \hat{L}_2 + \hat{S}_2 \hat{L}_1 \\
K &= \hat{K}_1 + \hat{K}_2 - \hat{L}_2^* \hat{S}_2 \hat{L}_1.
\end{aligned} \tag{13}$$

2. Instantaneous Feedforward followed by Adiabatic Elimination

We perform the series product $(S_2(k), L_2(k), K_2(k)) \triangleleft (S_1(k), L_1(k), K_1(k))$ first to obtain $(S_{\text{ser}}(k), L_{\text{ser}}(k), K_{\text{ser}}(k))$ where

$$\begin{aligned}
S_{\text{ser}}(k) &= S_2 S_1, \\
L_{\text{ser}}(k) &= L_2(k) + S_2 L_1(k) \\
&\equiv k[S_2 C_1, C_2] a + G_1 + S_2 G_1, \\
K_{\text{ser}}(k) &= K_1(k) + K_2(k) - L_2(k)^* S_2(k) L_1(k) \\
&= k^2 a^* \begin{bmatrix} A_1 & 0 \\ -C_2^* S_2 C_1 & A_2 \end{bmatrix} a + k a^* \begin{bmatrix} Z_1 \\ Z_2 - C_2^* S_2 G_1 \end{bmatrix} \\
&\quad + k [X_1 - G_2^* S_2 C_1, X_2] a + R_1 + R_2 - G_2^* S_2 G_1.
\end{aligned}$$

Now, adiabatically eliminating the oscillators leads to the effective model $(\hat{S}_{\text{ser}}, \hat{L}_{\text{ser}}, \hat{K}_{\text{ser}})$.

Here we have

$$\begin{aligned}
\hat{S}_{\text{ser}} &= (I + [S_2 C_1, C_2] \begin{bmatrix} A_1 & 0 \\ -C_2^* S_2 C_1 & A_2 \end{bmatrix}^{-1} \begin{bmatrix} C_1^* S_2^* \\ C_2^* \end{bmatrix}) S_2 S_1, \\
\hat{L}_{\text{ser}} &= (G_1 + S_2 G_1) - [S_2 C_1, C_2] \begin{bmatrix} A_1 & 0 \\ -C_2^* S_2 C_1 & A_2 \end{bmatrix}^{-1} \begin{bmatrix} Z_1 \\ Z_2 - C_2^* S_2 G_1 \end{bmatrix} \\
\hat{K}_{\text{ser}} &= (R_1 + R_2 - G_2^* S_2 G_1) \\
&\quad - [X_1 - G_2^* S_2 C_1, X_2] \begin{bmatrix} A_1 & 0 \\ -C_2^* S_2 C_1 & A_2 \end{bmatrix}^{-1} \begin{bmatrix} Z_1 \\ Z_2 - C_2^* S_2 G_1 \end{bmatrix}.
\end{aligned} \tag{14}$$

E. Commutativity of the Limits: Systems in Series

The matrix inverse appearing in (14) is easily computed as a special case of the well-known formula for the inverse of block matrices (the earliest reference is credited to Banachiewicz⁸,

see subsection III A, however, like many matrix identities the origins may be considerably older)

$$\begin{bmatrix} A_1 & 0 \\ -C_2^* S_2 C_1 & A_2 \end{bmatrix}^{-1} = \begin{bmatrix} A_1^{-1} & 0 \\ A_2^{-1} C_2^* S_2 C_1 A_1^{-1} & A_2^{-1} \end{bmatrix}. \quad (15)$$

This yields the explicit form

$$\begin{aligned} \hat{S}_{\text{ser}} &= (I + S_2 C_1 A_1^{-1} C_1^* S_2^* + C_2 A_2^{-1} C_2^* S_2 C_1 A_1^{-1} C_1^* S_2^* + C_2 A_2^{-1} C_2^*) S_2 S_1 \\ &= (I + C_2 A_2^{-1} C_2^*) S_2 (I + C_1 A_1^{-1} C_1^*) S_1 \\ &\equiv \hat{S}_2 \hat{S}_1. \end{aligned}$$

The coupling operator is

$$\begin{aligned} \hat{L}_{\text{ser}} &= (G_1 + S_2 G_1) - S_2 C_1 A_1^{-1} Z_1 \\ &\quad - C_2 A_2^{-1} C_2^* S_2 C_1 A_1^{-1} Z_1 - C_2 A_2^{-1} Z_2 + C_2 A_2^{-1} C_2^* S_2 G_1 \\ &= (G_2 - C_2 A_2^{-1} Z_2) + (I + C_2 A_2^{-1} C_2^*) S_2 (G_1 - C_1 A_1^{-1} Z_1) \\ &\equiv \hat{L}_2 + \hat{S}_2 \hat{L}_1. \end{aligned}$$

Finally we see that

$$\begin{aligned} \hat{K}_{\text{ser}} &= R_1 + R_2 - G_2^* S_2 G_1 - X_1 A_1^{-1} Z_1 \\ &\quad + G_2^* S_2 C_1 A_1^{-1} Z_1 - X_2 A_2^{-1} Z_2 + X_2 A_2^{-1} C_2^* S_2 (G_1 - C_1 Z_1). \end{aligned}$$

We would like to show that this equals $\hat{K}_1 + \hat{K}_2 - \hat{L}_2^* \hat{S}_2 \hat{L}_1$, now we have

$$\begin{aligned} \hat{K}_1 + \hat{K}_2 - \hat{L}_2^* \hat{S}_2 \hat{L}_1 &= R_1 - X_1 A_1^{-1} Z_1 + R_2 - X_2 A_2^{-1} Z_2 \\ &\quad - (G_2^* - Z_2^* A_2^{-1*} C_2^*) (I + C_2 A_2^{-1} C_2^*) S_2 (G_1 - C_1 A_1^{-1} Z_1), \end{aligned}$$

and to compute this we note that $A_2 = -\frac{1}{2} C_2^* C_2 - i\Omega_2$ so that

$$\begin{aligned} A_2^{-1*} C_2^* (I + C_2 A_2^{-1} C_2^*) &= A_2^{-1*} (I + C_2^* C_2 A_2^{-1}) C_2^* \\ &= A_2^{-1*} (A_2 + C_2^* C_2) A_2^{-1} C_2^* \\ &= A_2^{-1*} (-A_2^*) A_2^{-1} C_2^* \\ &= -A_2^{-1} C_2^*, \end{aligned} \quad (16)$$

this yields

$$\begin{aligned} \hat{K}_1 + \hat{K}_2 - \hat{L}_2^* \hat{S}_2 \hat{L}_1 &= R_1 - X_1 A_1^{-1} Z_1 + R_2 - X_2 A_2^{-1} Z_2 \\ &\quad - G_2^* (I + C_2 A_2^{-1} C_2^*) S_2 (G_1 - C_1 A_1^{-1} Z_1) \\ &\quad - Z_2^* A_2^{-1} C_2^* S_2 (G_1 - C_1 A_1^{-1} Z_1). \end{aligned}$$

We therefore find that

$$\hat{K}_{\text{ser}} - (\hat{K}_1 + \hat{K}_2 - \hat{L}_2^* \hat{S}_2 \hat{L}_1) = \{X_2 + G_2^* C_2 + Z_2^*\} A_2^{-1} C_2^* S_2 (G_1 - C_1 Z_1)$$

however this vanishes identically by the second of identities (12).

We therefore conclude that the model parameters in (13) are identical with those in (14), therefore the adiabatic elimination and instantaneous feedforward limit commute.

F. Adiabatic Elimination: In-Loop Device

Next we want to extend our investigation to situations where we have a non-trivial feedback arrangement as illustrated in Fig. 6. The question again is whether the two limits commute.

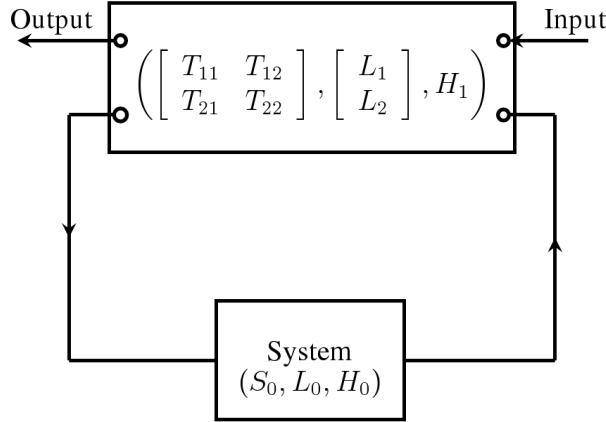

FIG. 6. General feedback arrangement: The four port device interacts with one external input, producing one external output and interacts with an in-loop device by one internal in- and output field respectively.

We start off with a simple model in-loop, taking the 4-port device to be a beam splitter, modeled by a unitary matrix $T = [T_{j\ell}]$ with complex entries and where coupling operators

and the systems Hamiltonian are zero, $L_1 = L_2 = H_1 = 0$. We parameterize the in-loop device as

$$\begin{aligned} S_0(k) &= S_0 \\ L_0(k) &= k\sqrt{\gamma}a_0 \\ K_0(k) &= -\frac{1}{2}k^2a_0^*\gamma a_0. \end{aligned} \tag{17}$$

and fix the beam splitter (scattering) matrix as (with α real)

$$T = \begin{bmatrix} \alpha & \sqrt{1-\alpha^2} \\ \sqrt{1-\alpha^2} & -\alpha \end{bmatrix}. \tag{18}$$

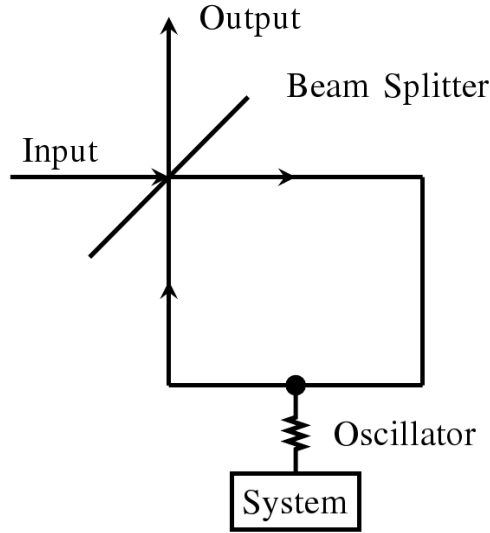

FIG. 7. Oscillator in-loop

Thus, the in-loop system consists only of a single oscillator coupled to the in-loop field and no additional modes coupled to the oscillator. In terms of operator parameters $S_0, C_0, G_0, A_0, Z_0, X_0, R_0$, see equation (10),

$$\begin{aligned} S_0(k) &= S_0 \otimes I \\ L_0(k) &= kC_0 \otimes a + G_0 \otimes I \\ K_0(k) &= k^2A_0 \otimes a^*a + kZ_0 \otimes a^* + kX_0 \otimes a + R_0 \otimes I \end{aligned}$$

acting on the space $\mathfrak{h}_{\text{sys}} \otimes \mathfrak{h}_{\text{osc}}$, we see that

$$\begin{aligned} S_0 &= S_0 \\ A_0 &= -\frac{1}{2}\gamma \\ C_0 &= \sqrt{\gamma} \\ Z_0 &= X_0 = R_0 = G_0 = 0. \end{aligned}$$

The coefficients for the single input single output device after taking the instantaneous feedback limit of the arrangement of Fig. 6 were derived by Gough and James⁴ and are given by

$$\begin{aligned} S_{\text{red}} &= T_{11} + T_{12}S_0(I - T_{22}S_0)^{-1}T_{21} \\ L_{\text{red}} &= T_{12}(I - T_{22}S_0)^{-1}L_0 \\ H_{\text{red}} &= K_0 - L_0^*S_0(I - T_{22}S_0)^{-1}L_0. \end{aligned} \tag{19}$$

For the model (17), the limit coefficients after taking the adiabatic elimination limit (see Theorem 1) are given by

$$\begin{aligned} \hat{S}_0 &= (I + C_0A_0^{-1}C_0^*)S_0 = -S_0, \\ \hat{L}_0 &= G_0 - C_0A_0^{-1}Z_0 = 0, \\ \hat{K}_0 &= R_0 - X_0A_0^{-1}Z_0 = 0. \end{aligned} \tag{20}$$

Substituting into (19) we find that the reduced coefficients after the instantaneous feedback limit for the model (20) are

$$\begin{aligned} \hat{S} &= \alpha + \sqrt{1 - \alpha^2}(-S_0) \frac{1}{1 - (-\alpha)(-S_0)} \sqrt{1 - \alpha^2} = \frac{\alpha - S_0}{1 - \alpha S_0} \\ \hat{L} &= 0 \\ \hat{K} &= 0. \end{aligned} \tag{21}$$

We now exchange the order in which we perform the limits. The instantaneous feedback limit of the model before taking the adiabatic elimination limit yields:

$$\begin{aligned} \tilde{S}(k) &= T_{11} + T_{12}S_0(I - T_{22}S_0)^{-1}T_{21} = \alpha + (1 - \alpha^2)S_0 \frac{1}{1 + \alpha S_0} \\ \tilde{L}(k) &= k\sqrt{1 - \alpha^2} \frac{1}{1 + \alpha S_0} \sqrt{\gamma}a_0 \\ \tilde{K}(k) &= K_0(k) - L_0(k)^* \frac{S_0 T_{22}}{1 - S_0 T_{22}} L_0(k) = k^2 a_0^* \left(-\frac{1}{2}\gamma + \gamma \frac{\alpha S_0}{1 + \alpha S_0} \right) a_0. \end{aligned}$$

where the operator parameters are

$$\begin{aligned}
A &= -\frac{\gamma}{2} \frac{1 - \alpha S_0}{1 + \alpha S_0} \\
C &= \frac{\sqrt{1 - \alpha^2} \sqrt{\gamma}}{1 + \alpha S_0} \\
S &= \alpha + \frac{(1 - \alpha^2) S_0}{1 + \alpha S_0} \\
G &= X = Z = R = 0
\end{aligned}$$

The A.E. of the I.F. limit model then results in (here $|1 + \alpha S_0|^2 = (1 + \alpha S_0^*)(1 + \alpha S_0)$)

$$\begin{aligned}
\hat{S} &= \left(1 - \frac{(1 - \alpha^2)\gamma}{|1 + \alpha S_0|^2} \frac{2}{\gamma} \frac{1 + \alpha S_0}{1 - \alpha S_0} \right) \left(\alpha + \frac{(1 - \alpha^2) S_0}{1 + \alpha S_0} \right) \\
&= \frac{(\alpha S_0^* - 1)(1 + \alpha S_0)}{(1 + \alpha S_0^*)(1 - \alpha S_0)} \left(\frac{\alpha + S_0}{1 + \alpha S_0} \right) \\
&= \frac{\alpha - S_0}{1 - \alpha S_0}.
\end{aligned} \tag{22}$$

We see that the limits do in fact commute since we obtain the same operator \hat{S} in (21) and (22), likewise for the operators \hat{L} and \hat{K} . The apparently miraculous agreement comes as a general feature that will be observed in more complex networks. Our approach will be to encode both these limits as instances of a Schur complement operation: the miraculous agreements that one encounters in a case-by-case study are in fact just by-product of these operations.

If $S_0 = 1$ then in quantum optics the system $(S_0(k), L_0(k), K_0(k))$ represents a one-sided optical cavity in which the coupling coefficient $k\sqrt{\gamma}$ of the partially transmitting cavity mirror is large (for large k). The calculations of this section show that for large k the network in Fig. 7 can be consistently approximated by an *effective* device that shifts the phase of the output field with respect to the input field by an amount determined by the parameters of the cavity and beam splitter. Alternatively, one can also think of the network of Fig. 7 as approximately implementing a phase shifting device.

III. ADIABATIC ELIMINATION WITHIN GENERAL NETWORKS

The situation of two systems in cascade, as depicted in Fig. 2, is the simplest form of a nontrivial quantum feedback network. We remark that at no stage of the calculations did we assume that the operators describing the first system commuted with those of the second

system. Indeed, the series product is valid even if we do not assume that we are dealing with separate cascaded systems and is applicable to the problem of feedback into the same system.

In Fig. 8 we describe a somewhat more engorged quantum feedback network featuring feedback and feedforward interconnections. For each component of the network, we will have the same multiplicity for the input fields as the output fields, though we split up the inputs and outputs geometrically to indicate different physical connections for the fields. The unitary S for a given component now additionally implies that we can use the component to mix the input fields, with a beam-splitter being the very special case where the entries of S are just complex constants. This feature introduces the possibility of topologically non-trivial feedback loops that were not present in the simple situations of direct feedforward or feedback occurring for systems in series.

We now aim to investigate the procedure of adiabatic elimination of fast degrees of freedom from components in a general quantum feedback network and, in particular, answer the question of whether this commutes with the Markov limit in which we take vanishing time lags for the various internal fields in the network. The adiabatic elimination of oscillators for components in series will then be a very specific case of this general theory.

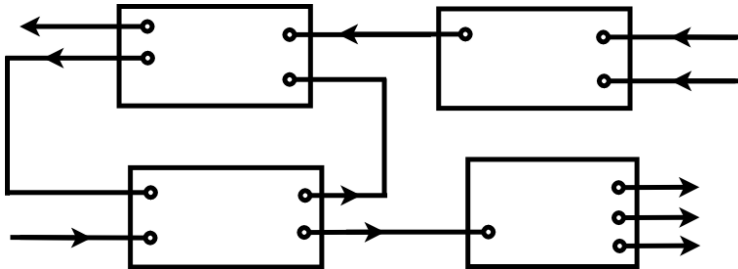

FIG. 8. Quantum feedback network

The essentially mathematical element in the investigation will be that both the adiabatic elimination limit and the instantaneous feedback limit for a general quantum feedback network are actually instances of a Schur complement of the Itô matrix \mathbf{G} .

A. The Schur Complement

We begin by recalling some of the basic definitions and notations relevant for Schur complements. For general reviews, see the survey article by Oullette⁶ or the book chapter

by Horn and Zhang⁷. We shall elaborate on several of the well-known results presented in the reviews, largely to take account of the fact that we are dealing with block-partitioned matrices with operator entries. In particular we give some minor technical extensions where we are explicit about the domains, kernel spaces and image spaces on which the operators act.

The Schur complement of an $(n + m)$ square matrix $M = \begin{bmatrix} A & B \\ C & D \end{bmatrix}$ relative to the $m \times m$ sub-block A is defined to be

$$M/A = D - CA^{-1}B$$

under the assumption that A is invertible. We note the following elementary formula, due to Banachiewicz⁸, for invertible M

$$\begin{bmatrix} A & B \\ C & D \end{bmatrix}^{-1} = \begin{bmatrix} A^{-1} + A^{-1}B(M/A)^{-1}CA^{-1} & -A^{-1}B(M/A)^{-1} \\ -(M/A)^{-1}CA^{-1} & (M/A)^{-1} \end{bmatrix}.$$

Definition 4 A matrix M^- is a generalized inverse for a square matrix M if we have $MM^-M = M$. The generalized Schur complement of $M = \begin{bmatrix} A & B \\ C & D \end{bmatrix}$ is then defined to be

$$M/A = D - CA^-B. \tag{23}$$

Lemma 5 The generalized Schur complement M/A is well-defined and independent of the choice of the generalized inverse A^- so long as we have the following inclusions of image spaces $\text{im } B \subseteq \text{im } A$ and kernel spaces $\ker A \subseteq \ker C$.

Note that $\text{im } B \subseteq \text{im } A$ occurs if and only if $\ker A^* \subseteq \ker B^*$. (Recall that the image, or column space, of a matrix is the span of its columns, or more generally $\text{im } (M) = \ker (M^*)^\perp$.)

Lemma 6 For two matrices M and N and some generalized inverse M^- of M we have that

$$MM^-N = N \text{ if } \text{im } N \subset \text{im } M$$

and

$$NM^-M = N \text{ if } \ker M \subset \ker N.$$

For the proofs of these lemmata, see Horn and Zhang⁷; they are a straightforward consequence of the definition of a generalized inverse and the postulated image/kernel inclusions.

The Schur complement and Lemmata 5 and 6 above may be generalized to matrices with operator entries. Let M be a bounded invertible operator on a Hilbert space \mathfrak{H} and let us fix a decomposition $\mathfrak{H} = \bigoplus_{j \in \mathfrak{J}} \mathfrak{H}_j$ for some finite index set \mathfrak{J} . We denote by x_j the component of a vector $x \in \mathfrak{H}$ in \mathfrak{H}_j , and M_{jl} the block component of M mapping from \mathfrak{H}_j to \mathfrak{H}_l . For $A = \{a_1, \dots, a_n\}$ and $B = \{b_1, \dots, b_m\}$ non-empty subsets of \mathfrak{J} we write

$$x_A = \begin{bmatrix} x_{a_1} \\ \vdots \\ x_{a_m} \end{bmatrix}, M_{A,B} = \begin{bmatrix} M_{a_1 b_1} & \cdots & M_{a_1 b_m} \\ \vdots & \ddots & \vdots \\ M_{a_n b_1} & \cdots & M_{a_n b_m} \end{bmatrix}.$$

The single equation $Mx = u$ then corresponds to the coarsest block form $M_{\mathfrak{J},\mathfrak{J}}x_{\mathfrak{J}} = u_{\mathfrak{J}}$. In contrast, the full system of equations $\sum_{l \in \mathfrak{J}} M_{jl}x_l = u_j$ gives the finest block form. More generally, we may examine intermediate partitions. Let A and B be non-trivial (i.e., non-empty, proper) subsets of \mathfrak{J} then the equation $Mx = u$ may be written as

$$\begin{bmatrix} M_{A,B} & M_{A,B'} \\ M_{A',B} & M_{A',B'} \end{bmatrix} \begin{bmatrix} x_B \\ x_{B'} \end{bmatrix} = \begin{bmatrix} u_A \\ u_{A'} \end{bmatrix}, \quad (24)$$

where A' denotes the complement of set A in \mathfrak{J} , and the inverse relation is

$$\begin{bmatrix} x_B \\ x_{B'} \end{bmatrix} = \begin{bmatrix} (M^{-1})_{B,A} & (M^{-1})_{B,A'} \\ (M^{-1})_{B',A} & (M^{-1})_{B',A'} \end{bmatrix} \begin{bmatrix} u_A \\ u_{A'} \end{bmatrix}. \quad (25)$$

We now recall the definition of the generalized Schur complement, sometimes also known as the shorted operator, in the case where M need not be invertible.

Definition 7 *Let A and B be non-trivial subsets of the index \mathfrak{J} , and let C be a non-trivial subset of A , and D be a nontrivial subset of B . Furthermore take $|A| = |B|$ and $|C| = |D|$. Suppose that the sub-block $M_{C,D}$ possesses a generalized inverse denoted by $(M_{C,D})^-$, then the Schur complement of $M_{A,B}$ relative to $M_{C,D}$ is defined to be*

$$M_{A,B}/M_{C,D} = M_{A/C,B/D} - M_{A/C,D}(M_{C,D})^-M_{C,B/D}.$$

In the special case where $A = B = \mathfrak{J}$, we shall simply write $M/M_{C,D}$ for $M_{\mathfrak{J},\mathfrak{J}}/M_{C,D}$.

The generalized Schur complement is well-defined and independent of the choice of generalized inverse so long as the column space $\text{im}(M_{C,B/D})$ is contained in $\text{im}(M_{C,D})$, and $\ker(M_{C,D})$ is contained in $\ker(M_{A/C,D})$. In particular, if the conditions of the Lemma 5 are met then we may fix a particular generalized inverse such as the Moore-Penrose inverse. We also remark that we may readily extend the above notation to the case where different direct-sum decompositions of \mathfrak{H} are used for the columns and rows of M .

We shall also require the extension of the Banachiewicz formula to generalized inverses. The proof for finite rank matrix operators is due to Marsaglia and Styan⁹, and may be found as Theorem 4.6 in the article of Ouellette⁶. In the next lemma, we strengthen this to deal with general Hilbert space operators.

Lemma 8 *Let M be partitioned according to $M = \begin{bmatrix} A & B \\ C & D \end{bmatrix}$. We suppose that $\text{im } B \subseteq \text{im } A$, $\ker A \subseteq \ker C$, and therefore the generalized Schur complement $X = M/A = D - CA^{-1}B$ is well-defined and independent of the choice of generalized inverse A^{-1} to A . Then the generalized inverse of M is given by*

$$M^{-1} = \begin{bmatrix} A^{-1} + A^{-1}BX^{-1}CA^{-1} & -A^{-1}BX^{-1} \\ -X^{-1}CA^{-1} & X^{-1} \end{bmatrix}.$$

Proof. We multiply out $MM^{-1}M$ in block form. The top left block will be

$$\begin{aligned} (MM^{-1}M)_{11} &= AA^{-1}A + AA^{-1}BX^{-1}CA^{-1}A - BX^{-1}CA^{-1}A \\ &\quad - AA^{-1}BX^{-1}C + BX^{-1}C \\ &= AA^{-1}A + AA^{-1}BX^{-1}C(A^{-1}A - 1) - BX^{-1}C(A^{-1}A - 1) \\ &= AA^{-1}A + (AA^{-1} - 1)BX^{-1}C(A^{-1}A - 1) \\ &= A, \end{aligned}$$

where the last step follows because $AA^{-1}A = A$ and $(AA^{-1} - 1)B = 0$ under the assumptions that $\text{im } B \subseteq \text{im } A$. Similarly

$$\begin{aligned} (MM^{-1}M)_{12} &= B + (AA^{-1} - 1)B + \\ &\quad (AA^{-1} - 1)BX^{-1}CA^{-1}B(AA^{-1} - 1)BX^{-1}D \\ &= B, \end{aligned}$$

since under the assumption $\text{im}B \subseteq \text{im}A$ we have that $AA^{-1}B = B$ and so $(AA^{-1} - 1)B = 0$;

$$\begin{aligned} (MM^{-1}M)_{21} &= C + C(A^{-1}A - 1) + (CA^{-1}B - D)X^{-1}C(A^{-1}A - 1) \\ &= C, \end{aligned}$$

because of the assumption $\ker A \subseteq \ker C$ we have $CA^{-1}A = C$ and $C(A^{-1}A - 1) = 0$; and

$$\begin{aligned} (MM^{-1}M)_{22} &= D - (D - CA^{-1}B) - (D - CA^{-1}B)X^{-1}(D - CA^{-1}B) \\ &= D - X + XX^{-1}X \\ &= D, \end{aligned}$$

since $X = M/A = D - CA^{-1}B$ and $XX^{-1}X = X$. Collecting these results we have that $MM^{-1}M = M$, as required. ■

Now, as a corollary to Lemma 8 we obtain the generalized Banachiewicz formula:

$$\begin{aligned} M_{B,A}^{-1} &= M_{A,B}^{-1} + M_{A,B}^{-1}M_{A,B'}(M/M_{A,B})^{-1}M_{A',B}M_{A,B}^{-1}, \\ M_{B,A'}^{-1} &= -M_{A,B}^{-1}M_{A,B'}(M/M_{A,B})^{-1}, \\ M_{B',A}^{-1} &= -(M/M_{A,B})^{-1}M_{A',B}M_{A,B}^{-1}, \\ M_{B',A'}^{-1} &= (M/M_{A,B})^{-1}. \end{aligned}$$

We now wish to establish the property of commutativity of successive Schur complementation as this shall be the main technical result required in this paper.

Lemma 9 (Successive complementation rule) *Suppose that A, B, C is a partition of the index set \mathfrak{J} (that is, A, B, C are disjoint non-empty subsets whose union is \mathfrak{J}) then, whenever the generalized Schur complements are well-defined, we have the rule*

$$\begin{aligned} M/M_{B \cup C, B \cup C} &= (M/M_{C,C})/(M/M_{C,C})_{B,B} \\ &= (M/M_{B,B})/((M/M_{B,B}))_{C,C}. \end{aligned} \tag{26}$$

For the case of matrices over a field where the inverses exist, the first equality in (26) is an instance of the Crabtree-Haynsworth quotient formula⁶. The extension of the quotient formula to generalized inverses for matrices over a field was given by Carson, Haynsworth and Markham¹⁰ under some rank conditions, see Theorem 4.8 in the review by Ouellete⁶. However, since here we are dealing with matrices with Hilbert space operator entries rather than just matrices over a field, we need to extend this result accordingly. To this end, below

we independently prove a generalization of the algebraic content of the theorem to matrices with Hilbert space operator entries, modulo the conditions for these Schur complements to be well-defined which we defer to Lemma 17 in the Appendix.

Proof. Assume that the conditions of Lemma 17 are in place. Let us first compute $(M/M_{C,C})/(M/M_{C,C})_{B,B}$:

$$\begin{aligned} M/M_{C,C} &= \begin{bmatrix} M_{A,A} & M_{A,B} & M_{A,C} \\ M_{B,A} & M_{B,B} & M_{B,C} \\ M_{C,A} & M_{C,B} & M_{C,C} \end{bmatrix} / M_{C,C} \\ &= \begin{bmatrix} M_{A,A} & M_{A,B} \\ M_{B,A} & M_{B,B} \end{bmatrix} - \begin{bmatrix} M_{A,C} \\ M_{B,C} \end{bmatrix} (M_{C,C})^{-1} [M_{C,A} \ M_{C,B}] \\ &= [M_{L,R} - M_{L,C}(M_{C,C})^{-1}M_{C,R}]_{R,L \in \{A,B\}} \end{aligned}$$

so a second Schur complementation leads to

$$\begin{aligned} (M/M_{C,C})/(M/M_{C,C})_{B,B} &= M_{A,A} - M_{A,C}(M_{C,C})^{-1}M_{C,A} \\ &\quad - (M_{A,B} - M_{A,C}(M_{C,C})^{-1}M_{C,B})\Xi(M_{B,A} - M_{B,C}(M_{C,C})^{-1}M_{C,A}), \end{aligned}$$

where we write $\Xi = (M_{B,B} - M_{B,C}(M_{C,C})^{-1}M_{C,B})^{-1}$ for shorthand. We then compute $M/M_{B \cup C, B \cup C}$

$$\begin{aligned} M/M_{B \cup C, B \cup C} &= \begin{bmatrix} M_{A,A} & M_{A,B} & M_{A,C} \\ M_{B,A} & M_{B,B} & M_{B,C} \\ M_{C,A} & M_{C,B} & M_{C,C} \end{bmatrix} / \begin{bmatrix} M_{B,B} & M_{B,C} \\ M_{C,B} & M_{C,C} \end{bmatrix} \\ &= M_{AA} - \begin{bmatrix} M_{A,B} & M_{A,C} \end{bmatrix} \begin{bmatrix} M_{B,B} & M_{B,C} \\ M_{C,B} & M_{C,C} \end{bmatrix}^{-1} \begin{bmatrix} M_{B,A} \\ M_{C,A} \end{bmatrix}, \end{aligned}$$

however, the inverse can be computed explicitly using the Banachiewicz formula as

$$\begin{bmatrix} \Xi & -\Xi M_{B,C}(M_{C,C})^{-1} \\ -(M_{C,C})^{-1}M_{C,B}\Xi & (M_{C,C})^{-1} + (M_{C,C})^{-1}M_{C,B}\Xi M_{B,C}(M_{C,C})^{-1} \end{bmatrix}.$$

Multiplying out the block matrix readily leads to the same expression already obtained for $(M/M_{C,C})/(M/M_{C,C})_{B,B}$. The second equality in (26) follows from Lemma 17 and by interchanging B and C . ■

B. Instantaneous Feedback Limit as Schur Complement

Suppose that we are given a collection of components which have separate descriptions (S_j, L_j, K_j) for $j = 1, 2, \dots, c$. We may collect them into a single model (S, L, K) given by

$$S = \begin{bmatrix} S_1 & 0 & \cdots & 0 \\ 0 & S_2 & \cdots & 0 \\ \vdots & \vdots & \ddots & 0 \\ 0 & 0 & 0 & S_c \end{bmatrix}, \quad L = \begin{bmatrix} L_1 \\ L_2 \\ \vdots \\ L_c \end{bmatrix}, \quad K = \sum_{j=1}^c K_j.$$

This just describes the open-loop system where no connections have been made and all input and output fields are therefore external.

To obtain the closed loop description we have to give a list of which outputs are to be fed back in as inputs. Algebraically, this comes down to assembling a total multiplicity space $\mathfrak{K} = \bigoplus_{j=1}^c \mathfrak{K}_j$ and a joint system space $\mathfrak{h} = \bigotimes_{j=1}^c \mathfrak{h}_j$. In this way we obtain a network matrix \mathbf{G} on $\mathfrak{h} \otimes (\mathbb{C} \oplus \mathfrak{K})$ from the component matrices \mathbf{G}_j on $\mathfrak{h}_j \otimes (\mathbb{C} \oplus \mathfrak{K}_j)$.

Once the connections have been specified, we arrive at a decomposition

$$\mathfrak{K} = \mathfrak{K}_e \oplus \mathfrak{K}_i$$

where \mathfrak{K}_e lists all the external fields and \mathfrak{K}_i lists all the internal fields. This decomposition induces a decomposition of \mathfrak{H} as

$$\mathfrak{h} \otimes (\mathbb{C} \oplus \mathfrak{K}) = [\mathfrak{h} \otimes (\mathbb{C} \oplus \mathfrak{K}_e)] \oplus [\mathfrak{h} \otimes \mathfrak{K}_i]$$

and with respect to this decomposition, the Itô matrix may be partitioned based on internal ('i') and external ('e') components as (see Gough and James⁴ for details)

$$\mathbf{G} = \begin{bmatrix} G_{ee} & G_{ei} \\ G_{ie} & G_{ii} \end{bmatrix}, \quad (27)$$

In Fig. 9 we sketch the picture that emerges when we subsume all the external fields together and all the internal fields together as single channels.

In the instantaneous feedback limit we find that the reduced model is described by the Itô matrix $\mathcal{F}\mathbf{G} \in \mathcal{B}(\mathfrak{h} \otimes (\mathbb{C} \oplus \mathfrak{K}_e))$ given by the Schur complement

$$\mathcal{F}\mathbf{G} = G_{ee} - G_{ei}(G_{ii})^{-1}G_{ie}, \quad (28)$$

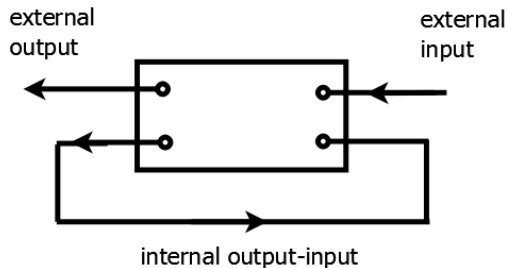

FIG. 9. Feedback situation

provided that G_{ii} exists. We remark that the original version of this formula⁴ involved the related *model matrix* $\mathbf{U} = \begin{bmatrix} K & -L^*S \\ L & S \end{bmatrix}$ rather than \mathbf{G} and the corresponding feedback reduction map was the fractional linear transformation $\mathcal{F}\mathbf{U} = U_{ee} + U_{ei}(1 - U_{ii})^{-1}U_{ie}$. In both cases, the condition that $G_{ii} = S_{ii} - I$ be invertible is necessary for the feedback network to be well-posed.

Remark 10 *We note that models studied here all satisfy a Hurwitz stability condition, though not necessarily in the strict sense. In general, the feedback reduction need not preserve the strictly Hurwitz property, and we may obtain conditionally stable modes through interconnection.*

C. Adiabatic Elimination as Schur Complement

We now re-examine the adiabatic elimination of oscillators. For finite k we consider the $\text{It}\bar{o}$ matrix

$$\mathbf{G}(k) = \begin{bmatrix} K(k) & -L(k)^*S \\ L(k) & S - I \end{bmatrix}$$

where we write the scaled operators (10) as

$$\begin{aligned} K(k) &= [I, ka^*] \begin{bmatrix} R & X \\ Z & A \end{bmatrix} \begin{bmatrix} I \\ ka \end{bmatrix}, \\ L(k) &= [I, ka^*] \begin{bmatrix} G & C \\ 0 & 0 \end{bmatrix} \begin{bmatrix} I \\ ka \end{bmatrix}, \\ S &= [I, ka^*] \begin{bmatrix} S & 0 \\ 0 & 0 \end{bmatrix} \begin{bmatrix} I \\ ka \end{bmatrix}. \end{aligned}$$

Recalling Remark 2 , it is now convenient to use the decomposition $\mathfrak{h} = \hat{\mathfrak{h}} \oplus \mathfrak{h}_f$ (here \mathfrak{h}_f denotes the subspace of the fast oscillator modes) to write

$$\mathfrak{h} \otimes (\mathbb{C} \oplus \mathfrak{K}) = \left[\hat{\mathfrak{h}} \otimes (\mathbb{C} \oplus \mathfrak{K}) \right] \oplus [\mathfrak{h}_f \otimes (\mathbb{C} \oplus \mathfrak{K})]$$

and with respect to this decomposition we may now write

$$\begin{aligned} \mathbf{G}(k) &= k^2 a^* g_{ffa} + ka^* g_{fs} + kg_{sfa} + g_{ss} \\ &\triangleq [I, ka^*] \begin{bmatrix} g_{ss} & g_{sf} \\ g_{fs} & g_{ff} \end{bmatrix} \begin{bmatrix} I \\ ka \end{bmatrix} \end{aligned} \quad (29)$$

and we set

$$g = \begin{bmatrix} g_{ss} & g_{sf} \\ g_{fs} & g_{ff} \end{bmatrix}. \quad (30)$$

It is easy to see that g is given by

$$\begin{aligned} g_{ss} &= \begin{bmatrix} R & -G^*S \\ G & S - I \end{bmatrix}, \quad g_{sf} = \begin{bmatrix} X & 0 \\ C & 0 \end{bmatrix}, \\ g_{fs} &= \begin{bmatrix} Z & -C^*S \\ 0 & 0 \end{bmatrix}, \quad g_{ff} = \begin{bmatrix} A & 0 \\ 0 & 0 \end{bmatrix}. \end{aligned}$$

The Itô matrix corresponding to the limit operators $(\hat{S}, \hat{L}, \hat{K})$ in (11) is then

$$\hat{\mathbf{G}} = \begin{bmatrix} \hat{K} & -\hat{L}^* \hat{S} \\ \hat{L} & \hat{S} \end{bmatrix} = \begin{bmatrix} R - XA^{-1}Z & -G^*S + XA^{-1}C^*S \\ G - CA^{-1}Z & S + CA^{-1}C^*S \end{bmatrix}$$

where we use the identity $-\hat{L}^* \hat{S} = -G^*S + XA^{-1}C^*S$ in the upper right corner which relies on the trick (16) along with the identities (12). We then observe that

$$\hat{\mathbf{G}} \equiv g_{ss} - g_{sf} (g_{ff})^{-} g_{fs} = g/g_{ff}$$

which is the generalized Schur complement based on the Moore-Penrose inverse

$$\begin{bmatrix} A & 0 \\ 0 & 0 \end{bmatrix}^{-} = \begin{bmatrix} A^{-1} & 0 \\ 0 & 0 \end{bmatrix}.$$

Indeed, given the specific form here we see from the remarks after the Definition 7 that any generalized inverse may be used here. We may then define the adiabatic elimination operator as $\mathcal{A} : \mathbf{G}(k) \mapsto \hat{\mathbf{G}} = g/g_{ff}$.

IV. COMMUTATIVITY OF THE LIMITS IN GENERAL NETWORKS

Our first step is to see how the instantaneous feedback limit sits with the adiabatic limit starting from a general model with fast oscillators and internal connections which we wish to eliminate.

We have seen from (29) that the Itô matrix $\mathbf{G}(k)$ may be written as $\mathbf{G}(k) = [I, ka^*]g \begin{bmatrix} I \\ ka \end{bmatrix}$ with g given by (30). Suppose that the input fields can be partitioned into internal and external fields that corresponds to a partitioning of S as

$$S = \begin{bmatrix} S_{ee} & S_{ei} \\ S_{ie} & S_{ii} \end{bmatrix},$$

where S_{ii} is a square matrix pertaining to the scattering of the internal fields to themselves, S_{ee} is a square matrix pertaining to the scattering of the external fields to themselves, while S_{ei} and S_{ie} pertains to a scattering of internal fields to external fields, and vice-versa, respectively. We also partition C and G accordingly as

$$C = \begin{bmatrix} C_e \\ C_i \end{bmatrix}; G = \begin{bmatrix} G_e \\ G_i \end{bmatrix}.$$

If we wish to decompose this with respect to the external and internal field labels, then we obtain

$$\mathbf{G}(k) \equiv \begin{bmatrix} G_{ee}(k) & G_{ei}(k) \\ G_{ie}(k) & G_{ii}(k) \end{bmatrix}$$

similar to (27). We note that these blocks will necessarily have the following structure

$$\begin{aligned} G_{ee}(k) &\equiv [I, ka^*]g_{ee} \begin{bmatrix} I \\ ka \end{bmatrix}, \\ G_{ei}(k) &\equiv [I, ka^*]g_{ei}, \\ G_{ie}(k) &\equiv g_{ie} \begin{bmatrix} I \\ ka \end{bmatrix}, \\ G_{ii}(k) &= g_{ii}, \end{aligned}$$

with

$$g_{ee} = \begin{bmatrix} R_1 & M_1 \\ G_1 & S_{ii} - I \end{bmatrix}; g_{ei} = \begin{bmatrix} X_1 & 0 \\ C_i & 0 \end{bmatrix};$$

$$g_{ie} = \begin{bmatrix} Z_1 & -C^* S_i \\ 0 & 0 \end{bmatrix}; g_{ii} = \begin{bmatrix} A & 0 \\ 0 & 0 \end{bmatrix},$$

and

$$S_e = \begin{bmatrix} S_{ee} \\ S_{ie} \end{bmatrix}, S_i = \begin{bmatrix} S_{ei} \\ S_{ii} \end{bmatrix}, R_1 = \begin{bmatrix} R & -G^* S_e \\ G_e & S_{ee} - I \end{bmatrix}, M_1 = \begin{bmatrix} -G^* S_i \\ S_{ei} \end{bmatrix},$$

$$G_1 = \begin{bmatrix} G_i & S_{ie} \end{bmatrix}, Z_1 = \begin{bmatrix} Z & -C^* S_e \end{bmatrix}, X_1 = \begin{bmatrix} X \\ C_e \end{bmatrix}.$$

We therefore obtain the feedback reduction

$$\mathcal{F}\mathbf{G}(k) = G_{ee}(k) \equiv [I, ka^*] (g/g_{ii}) \begin{bmatrix} I \\ ka \end{bmatrix}.$$

Conversely, the adiabatic elimination corresponds to

$$\mathcal{A}\mathbf{G}(k) = g/g_{ff}.$$

In this way we see that the essential action is a Schur complementation of the object g either with respect to labels of the fast oscillators of the system, or the labels of the internal fields. To this end, we can now establish the main technical result of this paper.

Theorem 11 *Let $\mathbf{G}(k)$ and $\mathcal{F}\mathbf{G}(k)$ correspond to strictly Hurwitz stable open quantum systems (i.e., the A matrix of each system is strictly Hurwitz stable), and suppose that $S_{ii} + C_i A^{-1} C^* S_i - I$ and $S_{ii} - I$ are invertible. Then in the notation established above we have*

$$\mathcal{A}\mathcal{F}\mathbf{G}(k) = \mathcal{F}\mathcal{A}\mathbf{G}(k).$$

The proof of the above theorem is given in the Appendix. Thus we establish that that if $\mathbf{G}(k)$ and $\mathcal{F}\mathbf{G}(k)$ are strictly Hurwitz stable systems, and $S_{ii} + C_i A^{-1} C^* S_i - I$ and $S_{ii} - I$ are invertible, the operation of adiabatic elimination of the oscillators in the network indeed commutes with the operation of taking the instantaneous feedback limit. For the systems in series example of section IID it can be seen that the strictly Hurwitz stable property holds

when A_1 and A_2 are strictly Hurwitz stable, while for the beam splitter with an in-loop device of section II F it holds when $|\alpha| < 1$.

The requirement that $\mathbf{G}(k)$ and $\mathcal{F}\mathbf{G}(k)$ be strictly Hurwitz is due to Remark 10. Note that the strict Hurwitz condition is not however necessary and that the limits may more generally commute whenever the kernel property of Y in Theorem 1 holds.

V. CONCLUSION

In this paper we have studied the question of commutativity of adiabatic elimination of oscillatory components and the operation of taking the instantaneous feedback limit in a quantum network with Markovian components. Provided some mild conditions are satisfied, we answer the question in the affirmative by showing that adiabatic elimination can be viewed as a Schur complementation operation, thus putting it on the same footing as the instantaneous feedback limit, and subsequently proving the commutativity of successive Schur complementation. This result is important from a practical point of view because in practice it is much easier to obtain a simplified description of a quantum network by first obtaining simplified component models and then using them to obtain a description of the network rather than the converse operation of first forming the (possibly large) network and applying adiabatic elimination at the network level. Since we have shown that the order in which adiabatic elimination and the instantaneous feedback limit is taken is inconsequential, this justifies employing the former order of operations which is free of any concerns regarding the uniqueness of the resulting simplified network model in which the fast oscillatory components have been eliminated.

VI. APPENDIX

A. Proof of Theorem 1

Let us set

$$M_N = \hat{\mathfrak{h}} \otimes \text{span} \left\{ |\mathbf{n}\rangle : \sum n_j = N \right\},$$

for $N = 0, 1, 2, \dots$. In particular, we have the direct sum of orthogonal subspaces $\hat{\mathfrak{h}} \otimes \mathfrak{h}_{\text{osc}} = \bigoplus_{N \geq 0} M_N$. Let P_s be orthogonal projection onto the ‘‘slow subspace’’ $M_0 = \mathfrak{h}_s = \hat{\mathfrak{h}} \otimes \mathbb{C}|0\rangle_{\text{osc}}$

and let $P_f = I - P_s$. Recall the hypothesis that $\ker(Y) = \mathfrak{h}_s$. We first have the following:

Lemma 12 *Under the hypothesis $\ker(Y) = \mathfrak{h}_s$, the subspaces M_N are stable under $Y_N = Y|_{M_N}$, and we have*

$$(P_f Y P_f)^{-1} = \bigoplus_{N \geq 1} Y_N^{-1}.$$

Moreover, let $|\delta_j\rangle$ be the state where the j -th mode is in the first excited state and all others are in the vacuum, then $(Y_1)^{-1} \sum_j \phi_j \otimes |\delta_j\rangle = \sum_{jl} (A^{-1})_{jl} \phi_l \otimes |\delta_j\rangle$.

Proof. Stability and invertibility of Y_N on M_N follows directly from the specific form of Y_N and the fact that Y has kernel space M_0 . The relation $(P_f Y P_f)^{-1} = \bigoplus_{N \geq 1} Y_N^{-1}$ follows from the direct sum decomposition.

The remaining identity is easily checked from $Y \sum_j \phi_j \otimes |\delta_j\rangle = \sum_{jl} A_{jl} \phi_l \otimes |\delta_j\rangle$ and setting this equal to $\sum_j \tilde{\phi}_j \otimes |\delta_j\rangle$ we deduce that $\phi_l = (A^{-1})_{lj} \tilde{\phi}_j$. ■

Corollary 13 $\ker(Y^*) = M_0$.

Proof. By the preceding lemma we have that $\mathfrak{h}_f = P_f \hat{\mathfrak{h}} \otimes \mathfrak{h}_{\text{osc}}$ is stable under Y . Therefore, for any $\phi \in M_0$ and $\psi \in \hat{\mathfrak{h}} \otimes \mathfrak{h}_{\text{osc}}$ we have that $\langle \phi, Y \psi \rangle = \langle \phi, Y P_f \psi \rangle = 0$. It follows that $\langle Y^* \phi, \psi \rangle = \langle \phi, Y \psi \rangle = 0$ for all $\psi \in \hat{\mathfrak{h}} \otimes \mathfrak{h}_{\text{osc}}$, thus $Y^* \phi = 0$ for any $\phi \in M_0$ and we conclude that $M_0 \subseteq \ker(Y^*)$. We now need to show the converse that $\ker(Y^*) \subseteq M_0$ and we will do this by contradiction. To do this end, suppose that $\exists \varphi \in P_f \hat{\mathfrak{h}} \otimes \mathfrak{h}_{\text{osc}}$ with $\varphi \neq 0$ such that $\langle Y^* \varphi, \psi \rangle = 0$ for all $\psi \in \hat{\mathfrak{h}} \otimes \mathfrak{h}_{\text{osc}}$. It follows that $\langle \varphi, Y \psi \rangle = 0$ and therefore $\langle \varphi, Y P_f \psi \rangle = 0$ for all $\psi \in \hat{\mathfrak{h}} \otimes \mathfrak{h}_{\text{osc}}$. But since \mathfrak{h}_f is stable under Y and $Y|_{\mathfrak{h}_f}$ is invertible, it follows that $\varphi \in \mathfrak{h}_s$. But this contradicts the hypothesis that φ is a non-zero element of \mathfrak{h}_f and therefore we conclude that $\ker(Y^*) \subseteq M_0$. This concludes the proof. ■

We now state a sufficient condition for $\ker(Y) = M_0 = \ker(Y^*)$. Let us first recall the following definition

Definition 14 *A bounded Hilbert space operator A is strictly Hurwitz stable if*

$$\text{Re}\langle \psi | A \psi \rangle < 0, \text{ for all } \psi \neq 0.$$

Lemma 15 *Let $A_{jl} \in \mathcal{B}(\hat{\mathfrak{h}})$ such that $A = [A_{jl}] \in \mathcal{B}(\hat{\mathfrak{h}} \otimes \mathbb{C}^m)$ is strictly Hurwitz stable. Then the operator*

$$Y = \sum_{jl} A_{jl} \otimes a_j^* a_l \tag{31}$$

on $\hat{\mathfrak{h}} \otimes \mathfrak{h}_{\text{osc}}$ has kernel consisting of vectors of the form $\phi \otimes |0\rangle_{\text{osc}}$, where $\phi \in \hat{\mathfrak{h}}$.

Proof. We see that for $\psi \in \hat{\mathfrak{h}} \otimes \mathfrak{h}_{\text{osc}}$

$$\langle \psi | Y \psi \rangle = \sum_{jl} \langle \psi | (I \otimes a_j)^* (A_{jl} \otimes I) (I \otimes a_l) \psi \rangle = \sum_{jl} \langle \psi_j | A_{jl} \otimes I \psi_l \rangle$$

where $\psi_j = (I \otimes b_j) \psi$. We may decompose $\psi_j \equiv \sum_{\mathbf{n}} \psi_j(\mathbf{n}) \otimes |\mathbf{n}\rangle$, where $|\mathbf{n}\rangle$ is the orthonormal basis of number states for the oscillators and $\psi_j(\mathbf{n}) \in \hat{\mathfrak{h}}$. Then

$$\langle \psi | Y \psi \rangle = \sum_{\mathbf{n}} \sum_{jl} \langle \psi_j(\mathbf{n}) | A_{jl} \psi_l(\mathbf{n}) \rangle$$

and, for each fixed \mathbf{n} , we have $\sum_{jl} \langle \psi_j(\mathbf{n}) | A_{jl} \psi_l(\mathbf{n}) \rangle \leq 0$ with equality if and only if the $\psi_j(\mathbf{n}) = 0$ since $[A_{jl}]$ is assumed to be strictly Hurwitz. In particular, if we assume that ψ is in the kernel of Y then we deduce that $\psi_j(\mathbf{n}) = 0$ for each \mathbf{n} and $j = 1, \dots, m$. It follows that $\psi_j = (I \otimes b_j) \psi = 0$ for each $j = 1, \dots, m$, and this implies that $\psi \equiv \phi \otimes |0\rangle_{\text{osc}}$ for some $\phi \in \hat{\mathfrak{h}}$ as required. ■

Note, however, that as we shall see below, for Theorem 1 to hold it is enough that $\ker(Y) = M_0$.

Lemma 16 *The operator \hat{S} is unitary and $\hat{K} + \hat{K}^* + \hat{L}^* \hat{L} = 0$.*

Proof. We first show that $I + CA^{-1}C^*$ is invertible. Suppose that $u \in \ker(I + CA^{-1}C^*)$

$$\begin{aligned} u = -CA^{-1}C^*u &\Rightarrow C^*u = -C^*CA^{-1}C^*u \Rightarrow (I + C^*CA^{-1})C^*u = 0 \\ &\Rightarrow (A + C^*C)A^{-1}C^*u = 0 \Rightarrow -A^*A^{-1}C^*u = 0 \Rightarrow C^*u = 0 \end{aligned}$$

so substituting $C^*u = 0$ into $u = -CA^{-1}C^*u$ we see that $u = 0$, therefore $\ker \hat{S} = 0$. As S is unitary, we have

$$\begin{aligned} \hat{S}\hat{S}^* &= (I + C^*A^{-1}C) (I + CA^{*-1}C^*) \\ &= I + CA^{-1}(A + A^* + C^*C)A^{*-1}C^* = I \end{aligned}$$

using the first of identities (12). Similarly $\hat{S}^*\hat{S} = I$.

Likewise we use (12) to show that

$$\begin{aligned} \hat{K} + \hat{K}^* + \hat{L}^* \hat{L} &= R - XA^{-1}Z + R^* - Z^*A^{*-1}X^* \\ &\quad + (G^* - Z^*A^{*-1}C^*) (G - CA^{-1}Z) \\ &= -(X - G^*C)A^{-1}Z - Z^*A^{*-1}(X^* - C^*G - C^*CA^{-1}Z) \\ &= Z^*A^{-1}Z + Z^*A^{*-1}(Z + C^*CA^{-1}Z) \\ &= Z^*A^{*-1}(A + A^* + C^*C)A^{-1}Z \\ &= 0. \end{aligned}$$

■

Using the above results, we can now proceed to complete the proof of Theorem 1. Let us first recall the main results from Bouten, van Handel, and Silberfarb¹³. Let $V(t, k) = U(t, k)^*$, then V satisfies the left QSDE (using a summation convention)

$$dV(t, k) = V(t, k) \{ \alpha(k) \otimes dt + \beta_l(k) \otimes dB_l(t) + \gamma_j \otimes dB_j(t)^* + (\varepsilon_{jl} - \delta_{jl}) \otimes d\Lambda_{jl}(t) \},$$

where $\alpha(k) = k^2\alpha_2 + k\alpha_1 + \alpha_0 = K(k)^*$, $\beta_j(k) = k\beta_{1,j} + \beta_{0,j} = L_j(k)^*$, $\gamma_j(k) = -S_{lj}^*L_l$ and $\varepsilon_{jl} = S_{lj}^*$. Their results are stated for the left QSDE for the reason that it is easier to formulate the conditions for unbounded coefficients this way, however, the treatment is of course equivalent.

We note that α_2 is then Y^* , with kernel space M_0 , and we denote its Moore-Penrose inverse by $\tilde{\alpha}_2$ (note that this Moore-Penrose inverse exists since Y^* has the same form and properties as Y). The pre-limit coefficients satisfy Assumption 1 in the paper of Bouten, van Handel, and Silberfarb¹³ by construction. Assumption 2 of that work correspond to the identities $\alpha_2\tilde{\alpha}_2 = \tilde{\alpha}_2\alpha_2 = P_f$, $\alpha_2P_s = 0$, $\beta_{1,i}^*P_s = 0$ and $P_s\alpha_1P_s = 0$: the last three are automatic since P_s projects onto the ground state of the oscillator and in each case we encounter $a_j|0\rangle_{\text{osc}} = 0$. The limit coefficients in Assumption 3 of¹³ are then

$$\begin{aligned} \hat{\alpha} &= P_s(\alpha_0 - \alpha_1\tilde{\alpha}_2\alpha_1)P_s = (R^* - Z^*A^{*-1}X^*) \otimes |0\rangle\langle 0|_{\text{osc}} \equiv \hat{K}^* \otimes |0\rangle\langle 0|_{\text{osc}}, \\ \hat{\beta} &= P_s(\beta_0 - \alpha_1\tilde{\alpha}_2\beta_1)P_s = (G^* - Z^*A^{*-1}C^*) \otimes |0\rangle\langle 0|_{\text{osc}} \equiv \hat{L}^* \otimes |0\rangle\langle 0|_{\text{osc}}, \\ \hat{\varepsilon} &= P_s\varepsilon(I + \beta_1^*\tilde{\alpha}_2\beta_1)P_s = S^*(I + C^*A^{*-1}C^*) \otimes |0\rangle\langle 0|_{\text{osc}} \equiv \hat{S}^* \otimes |0\rangle\langle 0|_{\text{osc}}, \\ \hat{\gamma} &\equiv -\hat{\varepsilon}\hat{\beta}^* \equiv -\hat{S}^*\hat{L} \otimes |0\rangle\langle 0|_{\text{osc}}, \end{aligned}$$

with $(\hat{S}, \hat{L}, \hat{K})$ as given in the statement of Theorem 1. These coefficients evidently satisfy the requirements of Assumption 3, namely to generate a unitary adapted Hudson-Parthasarathy equation on a common invariant domain in M_0 , as was established in Lemma 16. ■

B. Conditions for the Schur complements in Lemma 9 to be well-defined

Lemma 17 *If*

$$\ker \begin{bmatrix} M_{B,B} & M_{B,C} \\ M_{C,B} & M_{C,C} \end{bmatrix} \subseteq \ker [M_{A,B} \ M_{A,C}] \quad (32)$$

$$\operatorname{im} \begin{bmatrix} M_{B,A} \\ M_{C,A} \end{bmatrix} \subseteq \operatorname{im} \begin{bmatrix} M_{B,B} & M_{B,C} \\ M_{C,B} & M_{C,C} \end{bmatrix} \quad (33)$$

$$\ker M_{C,C} \subseteq \ker M_{B,C} \quad (34)$$

$$\operatorname{im} M_{C,B} \subseteq \operatorname{im} M_{C,C} \quad (35)$$

$$\ker M_{B,B} \subseteq \ker M_{C,B} \quad (36)$$

$$\operatorname{im} M_{B,C} \subseteq \operatorname{im} M_{B,B}, \quad (37)$$

then the Schur complements $(M/M_{C,C})/(M/M_{C,C})_{B,B}$ and $(M/M_{B,B})/((M/M_{B,B}))_{C,C}$ are all well-defined.

Proof. Collecting the Schur complements used in the proof of Lemma 9 (successive complementation rule), we see that we have to show that

$$\begin{aligned} &M/M_{C,C}, \ M/M_{B,B}, \ (M/M_{C,C})/(M/M_{C,C})_{B,B} \\ &M_{AUC,AUC}/M_{C,C}, \ M_{AUC,BUC}/M_{C,C}, \ M_{BUC,AUC}/M_{C,C} \end{aligned}$$

exist. To proceed, first note that, by Lemma 5, (32)-(37) imply that

$$M/M_{BUC,BUC}, \ M_{BUC,BUC}/M_{B,B}, \ M_{BUC,BUC}/M_{C,C}$$

are well-defined. From $\ker M_{B,B} \subseteq \ker M_{C,B}$, we see that $M_{B,B}x = 0 \Rightarrow M_{C,B}x = 0$. This

combined with condition (32) shows that $M_{B,B}x = 0 \Rightarrow \begin{bmatrix} M_{B,B} \\ M_{C,B} \end{bmatrix} x = 0 \Rightarrow M_{A,B}x = 0$.

Thus (39), given below, holds. Now, (33) implies that $\forall x \exists y, z$ such that

$$\begin{bmatrix} M_{B,A} \\ M_{C,A} \end{bmatrix} x = \begin{bmatrix} M_{B,B}y + M_{B,C}z \\ M_{C,B}y + M_{C,C}z \end{bmatrix}. \quad (38)$$

But conditions (35) and (37) imply that $\exists w, v$ such that $M_{C,B}y = M_{C,C}v$ and $M_{B,C}z = M_{B,B}w$. This together with (38) shows that $\operatorname{im} M_{B,A} \subseteq \operatorname{im} M_{B,B}$ and $\operatorname{im} M_{C,A} \subseteq \operatorname{im} M_{C,C}$.

Combining this with (37) gives us (40), given below. By analogous arguments we can also establish (41) and (42).

$$\ker M_{B,B} \subseteq \ker \begin{bmatrix} M_{A,B} \\ M_{C,B} \end{bmatrix} \quad (39)$$

$$\text{im} [M_{B,A} \ M_{B,C}] \subseteq \text{im} M_{B,B} \quad (40)$$

$$\ker M_{C,C} \subseteq \ker \begin{bmatrix} M_{A,C} \\ M_{B,C} \end{bmatrix} \quad (41)$$

$$\text{im} [M_{C,A} \ M_{C,B}] \subseteq \text{im} M_{C,C} \quad (42)$$

From (39) to (42) it follows directly that $M/M_{B,B}$ and $M/M_{C,C}$ exist. Existence of $M_{AUC,AUC}/M_{C,C}$, $M_{AUC,BUC}/M_{C,C}$ and $M_{BUC,AUC}/M_{C,C}$ follows immediately from (41) and (42).

Now we show that $(M/M_{C,C})/(M/M_{C,C})_{B,B}$ exists. We require

$$\ker(M_{B,B} - M_{B,C}M_{C,C}^-M_{C,B}) \subseteq \ker(M_{A,B} - M_{A,C}M_{C,C}^-M_{C,B})$$

$$\text{im}(M_{B,A} - M_{B,C}M_{C,C}^-M_{C,A}) \subseteq \text{im}(M_{B,B} - M_{B,C}M_{C,C}^-M_{C,B})$$

Let $v \in \text{im}(M_{B,A} - M_{B,C}M_{C,C}^-M_{C,A})$ be

$$\begin{aligned} v &= (M_{B,A} - M_{B,C}M_{C,C}^-M_{C,A})x \\ &= [1 \ -M_{B,C}M_{C,C}^-] \begin{bmatrix} M_{B,A}x \\ M_{C,A}x \end{bmatrix}, \end{aligned}$$

for some vector x . Using (33) and noting that $M_{B,C}M_{C,C}^-M_{C,C} = M_{B,C}$ (due to (34) and Lemma 6) leads to

$$\begin{aligned} v &= [1 \ -M_{B,C}M_{C,C}^-] \begin{bmatrix} M_{B,B}y + M_{B,C}z \\ M_{C,B}y + M_{C,C}z \end{bmatrix} \\ &= (M_{B,B} - M_{B,C}M_{C,C}^-M_{C,B})x \end{aligned}$$

which shows the required image space inclusion.

To show that $\ker(M_{B,B} - M_{B,C}M_{C,C}^-M_{C,B}) \subseteq \ker(M_{A,B} - M_{A,C}M_{C,C}^-M_{C,B})$ holds we choose some $x \in \ker(M_{B,B} - M_{B,C}M_{C,C}^-M_{C,B})$ and see that

$$M_{B,B}x - M_{B,C}M_{C,C}^-M_{C,B}x = [M_{B,B} \ M_{B,C}] \begin{bmatrix} x \\ -M_{C,C}^-M_{C,B}x \end{bmatrix} = 0$$

which implies that $\begin{bmatrix} x \\ -M_{C,C}^- M_{C,B} x \end{bmatrix} \in \ker [M_{B,B} \ M_{B,C}]$. However, $M_{C,B} x - M_{C,C} M_{C,C}^- M_{C,B} x = 0$ since $M_{C,C} M_{C,C}^- M_{C,B} = M_{C,B}$ (by (42) and Lemma 6). It then follows that

$$\begin{bmatrix} x \\ -M_{C,C}^- M_{C,B} x \end{bmatrix} \in \ker \begin{bmatrix} M_{B,B} & M_{B,C} \\ M_{C,B} & M_{C,C} \end{bmatrix}$$

which by (32) implies $\begin{bmatrix} x \\ -M_{C,C}^- M_{C,B} x \end{bmatrix} \in \ker [M_{A,B} \ M_{A,C}]$, and therefore we deduce $(M_{A,B} - M_{A,C} M_{C,C}^- M_{C,B})x = 0$ which proves the required kernel space inclusion. ■

We remark that the conditions (32)-(37) are not necessary, as is clear from Horn and Zhang⁷, page 42.

C. Proof of Theorem 11

The model may initially be described by the set of coefficients g over the space

$$\mathfrak{H} = (\hat{\mathfrak{h}} \oplus \hat{\mathfrak{h}}) \otimes (\mathbb{C} \oplus \mathfrak{K}_e \oplus \mathfrak{K}_i)$$

and we decompose this as

$$\mathfrak{H} = \mathfrak{H}_1 \oplus \mathfrak{H}_2 \oplus \mathfrak{H}_3 \oplus \mathfrak{H}_4$$

where

$$\begin{aligned} \mathfrak{H}_1 &= \hat{\mathfrak{h}} \otimes (\mathbb{C} \oplus \mathfrak{K}_e), && \text{Slow External} \\ \mathfrak{H}_2 &= \hat{\mathfrak{h}} \otimes \mathfrak{K}_i, && \text{Slow Internal} \\ \mathfrak{H}_3 &= \hat{\mathfrak{h}} \otimes (\mathbb{C} \oplus \mathfrak{K}_e), && \text{Fast External} \\ \mathfrak{H}_4 &= \hat{\mathfrak{h}} \otimes \mathfrak{K}_i, && \text{Fast Internal} \end{aligned}$$

With respect to this decomposition, we decompose g into sub-blocks as

$$g = \begin{bmatrix} g_{11} & g_{12} & g_{13} & g_{14} \\ g_{21} & g_{22} & g_{23} & g_{24} \\ g_{31} & g_{32} & g_{33} & g_{34} \\ g_{41} & g_{42} & g_{43} & g_{44} \end{bmatrix} \equiv \begin{bmatrix} R_1 & M_1 & X_1 & 0 \\ G_1 & S_{ii} - I & C_i & 0 \\ Z_1 & -C^* S_i & A & 0 \\ 0 & 0 & 0 & 0 \end{bmatrix}, \quad (43)$$

The set of labels $\mathcal{J} = \{1, 2, 3, 4\}$ can be split up into the slow labels $\{1, 2\}$ and the fast labels $F = \{3, 4\} = S'$ as well as the external labels $E = \{1, 3\}$ and the internal labels $I = \{2, 4\} = E'$.

To proceed, we must first establish that the generalized Schur complement is well-defined. Here we are ultimately retaining the “slow external” degrees of freedom (index 1) and eliminating the index sets $\{2, 3, 4\}$. To this end, We need to check that conditions (32)-(37) are all satisfied. We begin with (32).

Let $(x, y, z)^T$ be an element of $\ker \begin{bmatrix} S_{ii} - I & C_i & 0 \\ -C^*S_i & A & 0 \\ 0 & 0 & 0 \end{bmatrix}$. Then x, y satisfies $(S_{ii} - I)x + C_i y = 0$ and $-C^*S_i x + Ay = 0$, while z is arbitrary. Therefore, we have $y = A^{-1}C^*S_i x$ and $(S_{ii} + C_i A^{-1}C^*S_i - I)x = 0$. Since $S_{ii} + C_i A^{-1}C^*S_i - I$ is invertible by hypothesis, we find

that $x = 0$. It then follows that also $y = 0$, and we conclude that $\ker \begin{bmatrix} S_{ii} - I & C_i & 0 \\ -C^*S_i & A & 0 \\ 0 & 0 & 0 \end{bmatrix}$ consists of vectors of the form $(0, 0, z)^T$. Clearly such vectors lie in the kernel of $[M_1 \ X_1 \ 0]$

and we conclude that $\ker \begin{bmatrix} S_{ii} - I & C_i & 0 \\ -C^*S_i & A & 0 \\ 0 & 0 & 0 \end{bmatrix} \subseteq \ker [M_1 \ X_1 \ 0]$.

Next, we check if for every given vector x there exist vectors y and z such that we have the equality

$$\begin{bmatrix} G_1 x \\ Z_1 x \end{bmatrix} = \begin{bmatrix} S_{ii} - I & C_i \\ -C^*S_i & A \end{bmatrix} \begin{bmatrix} y \\ z \end{bmatrix}. \quad (44)$$

In particular, this will be satisfied if the matrix $\begin{bmatrix} S_{ii} - I & C_i \\ -C^*S_i & A \end{bmatrix}$ is invertible. However, since $S_{ii} - I + C_i A^{-1}C^*S_i$ and A are invertible we see that this simply follows from the Banachiewicz formula. Therefore, for any vector x there indeed exist vectors y and z such that (44) holds

and we conclude that $\text{im} \begin{bmatrix} G_1 \\ Z_1 \\ 0 \end{bmatrix} \subseteq \text{im} \begin{bmatrix} S_{ii} & C_i & 0 \\ -C^*S_i & A & 0 \\ 0 & 0 & 0 \end{bmatrix}$. Moreover, from the fact that A is

invertible we also get

$$\begin{aligned} \ker \begin{bmatrix} A & 0 \\ 0 & 0 \end{bmatrix} &\subseteq \ker [C_i \ 0], \\ \text{im} \begin{bmatrix} -C^*S_i \\ 0 \end{bmatrix} &\subseteq \text{im} \begin{bmatrix} A & 0 \\ 0 & 0 \end{bmatrix}, \end{aligned}$$

while from the invertibility of $S_{ii} - I$ we automatically have

$$\ker(S_{ii} - I) \subseteq \ker \begin{bmatrix} -C^* S_i \\ 0 \end{bmatrix},$$

$$\text{im} [C_i \ 0] \subseteq \text{im}(S_{ii} - I).$$

Therefore conditions (32)-(37) are satisfied, and the theorem now follows from Lemmata 17 and 9.

Acknowledgement J. Gough and H. Nurdin acknowledge the support of EPSRC research grant EP/H016708/1 “Quantum Control: Feedback Mediated by Channels in Non-classical States”. H. Nurdin also acknowledges the support of the Australian Research Council. The authors thank an anonymous reviewer for bringing their attention to survey paper of Ouellette⁶.

REFERENCES

- ¹C. Gardiner and P. Zoller, *Quantum Noise: A Handbook of Markovian and Non-Markovian Quantum Stochastic Methods with Applications to Quantum Optics*, 2nd ed., ser. Springer Series in Synergetics. Springer, (2000).
- ²R. L. Hudson and K. R. Parthasarathy, *Quantum Ito’s formula and stochastic evolutions*, Commun. Math. Phys. **93**, 301-323 (1984)
- ³K. Parthasarathy, *An Introduction to Quantum Stochastic Calculus*. Berlin: Birkhauser, (1992)
- ⁴J. Gough, M. R. James, *Quantum Feedback Networks: Hamiltonian Formulation*, Commun. Math. Phys., Volume **287**, 1109-1132, Number 3 / May, (2009)
- ⁵J. Gough, M. R. James, *The Series Product and Its Application to Quantum Feedforward and Feedback Networks*, IEEE Trans. Automatic Control, **54**(11):2530-2544, (2009)
- ⁶D.V. Ouellette, *Schur Complement and Statistics*, Linear Algebra and its applications, 36:187-295 (1981)
- ⁷R. Horn and F. Zhang, *Basic Properties of the Schur Complement*, in *The Schur Complement and Its Applications* (Ed. F. Zhang), Numerical Methods and Algorithms, Vol. **4**, Springer, (2005)
- ⁸T. Banachiewicz, *Zur Berechnung der Determination, Wie auch der Inversen, und der*

- darauf basierten Auflösung der Systeme linearer Gleichungen*, Acta Astronomica, Sèrie C, 3, 4167, (1937)
- ⁹G. Marsaglia, G.P.H. Styan, *Rank conditions for generalized inverses of partitioned matrices*, Sankhyā Ser. A 36: 437-442 (1974)
- ¹⁰D. Carlson, E. Haynsworth, and T. Markham, *A generalization of the Schur complement by means of the Moore-Penrose inverse*, SIAM J. Appl. Math. 26: 169-175 (1974)
- ¹¹J. E. Gough, R. van Handel, *Singular perturbation of quantum stochastic differential equations with coupling through an oscillator mode*, J. Stat. Phys. **127**, 575-607 (2007)
- ¹²L. Bouten, A. Silberfarb, *Adiabatic elimination in quantum stochastic models*, Commun. Math. Phys. **283**, 491-505 (2008)
- ¹³L. Bouten, R. van Handel, A. Silberfarb, *Approximation and limit theorems for quantum stochastic models with unbounded coefficients*, J. Funct. Analysis. **254**, 3123-3147 (2008)
- ¹⁴J. E. Gough, *Quantum Flows as Markovian Limit of Emission, Absorption and Scattering Interactions*, Commun. Math. Phys. Vol. 254, no.2, 489-512, March (2005)
- ¹⁵J. E. Gough, *Quantum Stratonovich Stochastic Calculus and the Quantum Wong-Zakai Theorem*, J. Math. Phys. 47, 113509, (2006)