

Constructing group actions on quasi-trees and applications to mapping class groups

Mladen Bestvina, Ken Bromberg and Koji Fujiwara*

September 1, 2014

Abstract

A quasi-tree is a geodesic metric space quasi-isometric to a tree. We give a general construction of many actions of groups on quasi-trees. The groups we can handle include non-elementary (relatively) hyperbolic groups, $CAT(0)$ groups with rank 1 elements, mapping class groups and $Out(F_n)$. As an application, we show that mapping class groups act on finite products of δ -hyperbolic spaces so that orbit maps are quasi-isometric embeddings. We prove that mapping class groups have finite asymptotic dimension.

Contents

1	Introduction	2
2	Applications of the construction	6
2.1	Mapping class groups	6
2.2	Hyperbolic-like groups	10
2.3	Bounded cohomology	14
2.4	$Out(F_n)$	14
2.5	The tree example	15
2.6	Plan of the paper	17

*The first two authors gratefully acknowledge the support by the National Science Foundation. The third author is supported in part by Grant-in-Aid for Scientific Research (No. 19340013)

3	The projection complex	18
3.1	Projection complex axioms	19
3.2	Monotonicity	19
3.3	The projection complex	25
3.4	Guards	26
3.5	Barriers	29
3.6	$\mathcal{P}_K(\mathbf{Y})$ is a quasi-tree	30
3.7	Group action on the projection complex	34
4	A quasi-tree of metric spaces	41
4.1	Axioms and construction	41
4.2	Distance estimate in $\mathcal{C}(\mathbf{Y})$	43
4.3	Hyperbolicity of $\mathcal{C}(\mathbf{Y})$	49
4.4	Group action and WWPD	53
4.5	Asymptotic dimension	55
4.6	$\mathcal{C}(\mathbf{Y})$ has finite asymptotic dimension	56
5	Mapping class group	58
5.1	Curve complexes	58
5.2	Partitioning subsurfaces into finitely many collections	61
5.3	Embedding MCG into a finite product of $\mathcal{C}(\mathbf{Y})$'s	64

1 Introduction

In this paper we define a new combinatorial complex which we call the *projection complex*, and a closely related complex called the *quasi-tree of metric spaces*. To motivate the construction consider a discrete group G of isometries of hyperbolic n -space \mathbb{H}^n and let $\gamma \in G$ be an element with an axis $\ell \subset \mathbb{H}^n$. Denote by \mathbf{Y} the set of all G -translates of ℓ , i.e. the set of axes of conjugates of γ . When $A, B \in \mathbf{Y}$, $A \neq B$, denote by $\pi_A(B) \subset A$ the image of B under the nearest point projection $\pi_A : \mathbb{H}^n \rightarrow A$. We call this set the *projection* of B to A and we observe:

(P0) The diameter $\text{diam } \pi_A(B)$ is uniformly bounded by $\theta \geq 0$, independently of $A, B \in \mathbf{Y}$.

This is because a line in \mathbb{H}^n will have a big projection to another line only if the two lines have long segments with small Hausdorff distance between them, since G is discrete (an easy exercise).

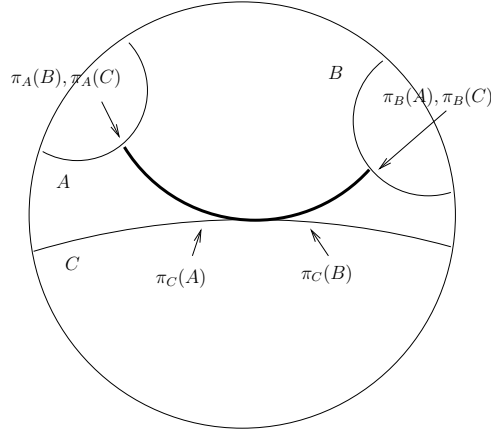

Figure 1: Axiom (P1). The bold line is the shortest segment between A and B . Note that C and this segment stay close for a long time, therefore $d_C^\pi(A, B)$ is large, while $d_A^\pi(B, C)$ and $d_B^\pi(A, C)$ are small.

When $B \neq A \neq C$ we define a pseudo-distance function (and abusing the terminology, we frequently drop “pseudo”)

$$d_A^\pi(B, C) = \text{diam}(\pi_A(B) \cup \pi_A(C))$$

which is symmetric and satisfies the triangle inequality, but in general we have $d_A^\pi(B, B) > 0$. We observe further, again since G is discrete, for a perhaps larger constant θ :

(P1) For any triple $A, B, C \in \mathbf{Y}$ of distinct elements at most one of the three numbers

$$d_A^\pi(B, C), d_B^\pi(A, C), d_C^\pi(A, B)$$

is greater than θ .

(P2) For any $A, B \in \mathbf{Y}$ the set

$$\{C \in \mathbf{Y} \mid d_C^\pi(A, B) > \theta\}$$

is finite.

For an even more basic example where (P0)-(P2) hold with $\theta = 0$ consider the Cayley tree of the free group $F_2 = \langle a, b \rangle$ and for \mathbf{Y} take the F_2 -orbit of the axis of a . We will discuss this example in more detail in Section 2.5.

The main construction in this paper reverses this procedure. We start with a collection of metric spaces \mathbf{Y} and a collection of subsets $\pi_A(B) \subset A$

for $A \neq B$ satisfying (P0)-(P2) and we “reconstruct” the ambient space. Note that in general the image of the nearest point projection to A of each point in B may contain more than one point (such functions are called *coarse maps*).

Theorem A. *Suppose \mathbf{Y} is a collection of geodesic metric spaces and for every $A, B \in \mathbf{Y}$ with $A \neq B$ we are given a subset $\pi_A(B) \subset A$ such that (P0)-(P2) hold. Then there is a geodesic metric space $\mathcal{C}(\mathbf{Y})$ that contains isometrically embedded, totally geodesic, pairwise disjoint copies of each $A \in \mathbf{Y}$ such that for all $A \neq B$ the nearest point projection of B to A in $\mathcal{C}(\mathbf{Y})$ is a uniformly bounded set uniformly close to $\pi_A(B)$.*

The space $\mathcal{C}(\mathbf{Y})$ will be called a *quasi-tree of metric spaces*, for reasons explained below. Its construction will depend on the choice of a sufficiently large parameter K , and it would be more precise to denote the space by $\mathcal{C}_K(\mathbf{Y})$. If $K < K'$ there is a natural Lipschitz map

$$\mathcal{C}_K(\mathbf{Y}) \rightarrow \mathcal{C}_{K'}(\mathbf{Y})$$

which is in general not a quasi-isometry, and in fact unbounded sets may map to bounded sets (see Section 2.5 for an example).

In addition, many properties that hold uniformly for the spaces in \mathbf{Y} carry over to $\mathcal{C}(\mathbf{Y})$. To state these results we first recall some definitions.

A *quasi-tree* is a geodesic metric space quasi-isometric to a tree. There is a characterization of quasi-trees due to Manning [Man05]. A geodesic metric space X satisfies the *bottleneck criterion* if there exists $\Delta \geq 0$ such that for any two points $x, y \in X$ the midpoint z of a geodesic between x and y satisfies the property such that any path from x to y intersects the Δ -ball centered at z . Manning showed that this is equivalent to X being a quasi-tree. The constant Δ is called the *bottleneck constant*.

The notion of *asymptotic dimension* was introduced by Gromov [Gro93] as a large-scale analog of the covering dimension. A metric space X has asymptotic dimension $\text{asdim}(X) \leq n$ if for every $R > 0$ there is a covering of X by uniformly bounded sets such that every metric R -ball intersects at most $n + 1$ of the sets in the cover. More generally, a collection of metric spaces has asdim at most n *uniformly* if for every R there are covers of each space as above whose elements are uniformly bounded over the whole collection.

Theorem B. Let $\mathcal{C}(\mathbf{Y})$ be the quasi-tree of metric spaces \mathbf{Y} constructed in Theorem A.

- (i) *The construction is equivariant with respect to any group, G , that acts isometrically on the disjoint union of the spaces in \mathbf{Y} preserving projections, i.e., $d_{g(A)}^\pi(g(B), g(C)) = d_A^\pi(B, C)$ for any $A, B, C \in \mathbf{Y}$ and $g \in G$.*
- (ii) *If each $X \in \mathbf{Y}$ is isometric to \mathbb{R} then $\mathcal{C}(\mathbf{Y})$ is a quasi-tree; more generally, if all $X \in \mathbf{Y}$ are quasi-trees with a uniform bottleneck constant then $\mathcal{C}(\mathbf{Y})$ is a quasi-tree.*
- (iii) *If each $X \in \mathbf{Y}$ is δ -hyperbolic with the same δ , then $\mathcal{C}(\mathbf{Y})$ is hyperbolic.*
- (iv) *If the collection \mathbf{Y} has $\text{asdim} \leq n$ uniformly, then $\text{asdim}(\mathcal{C}(\mathbf{Y})) \leq n+1$.*
- (v) *The quotient $\mathcal{C}(\mathbf{Y})/\mathbf{Y}$ obtained by collapsing the embedded copies of each $X \in \mathbf{Y}$ to a point is a quasi-tree.*

Note that (ii) in particular says that the space $\mathcal{C}(\mathbf{Y})$ obtained from an orbit of axes in \mathbb{H}^n as in the beginning of the introduction is a quasi-tree and not (quasi-isometric to) \mathbb{H}^n . The space $\mathcal{C}(\mathbf{Y})/\mathbf{Y}$ is the *projection complex* $\mathcal{P}(\mathbf{Y}) = \mathcal{P}_K(\mathbf{Y})$, which depends on K . The main technical theorem in this paper is the fact that $\mathcal{P}(\mathbf{Y})$ is a quasi-tree. We think of the quasi-tree of metric spaces $\mathcal{C}(\mathbf{Y})$ as being obtained from $\mathcal{P}(\mathbf{Y})$ by blowing up vertices to metric spaces, and thus the terminology.

Theorem A and Theorem B are collections of theorems proved mostly in Section 4.

Guide to the reader: Background, motivating examples, the main results and applications are contained in Sections 1 and 2. In particular the tree example in Section 2.5 will help the reader follow the axiomatic approach in Sections 3 and 4. These latter two sections are more technical. However, they start from a few simple axioms and do not require any hyperbolic geometry or facts about mapping class groups. In fact, Sections 3, 4.1 and 4.2 are entirely self-contained with the exception of the use of Manning's bottleneck property. The remaining subsections of Section 4 use some basic facts about δ -hyperbolic spaces and asymptotic dimension. The theorems about the mapping class group are proved in Section 5. If one prefers to skip Sections 3 and 4 one can read Section 5 using the results of the earlier sections as a black box.

Acknowledgments. The authors thank Martin Bridson, Pierre-Emmanuel Caprace, Kasra Rafi, John H. Hubbard and Johanna Mangahas for helpful discussions. We especially thank the referees for many useful comments and for suggestions how to significantly improve the exposition.

2 Applications of the construction

In this section we present applications of our construction. The main one we had in mind when we started this work is presented first. Some of the other applications were worked out by others after the first version of this paper was circulated.

Recall that a function $f : \mathcal{X} \rightarrow \mathcal{Y}$ between metric spaces is a *coarse embedding* if there are constants A, B and a function $\Phi : [0, \infty) \rightarrow [0, \infty)$ with $\Phi(t) \rightarrow \infty$ as $t \rightarrow \infty$ such that

$$\Phi(d_{\mathcal{X}}(x, x')) \leq d_{\mathcal{Y}}(f(x), f(x')) \leq A d_{\mathcal{X}}(x, x') + B$$

If we can take $\Phi(t) = A^{-1}t - B$, f is a *quasi-isometric embedding*, in other words, f gives a quasi-isometry between \mathcal{X} and its image by f in \mathcal{Y} .

2.1 Mapping class groups

Our main application in this paper is to the study of mapping class groups. To apply our methods here we will use the notion of subsurface projections of Masur-Minsky [MM00] which has been a driving force behind much of the recent development in the geometry of mapping class groups.

Let Σ be a closed orientable surface, possibly with finitely many punctures. The *mapping class group* $MCG(\Sigma)$ of Σ is the group of components of the orientation preserving diffeomorphism group preserving the punctures. For simplicity we will additionally assume that Σ has a complete hyperbolic structure of finite area in which the punctures correspond to cusps. The standard reference in the subject is [FM12].

To every isotopy class of π_1 -injective non-peripheral subsurfaces $Y \subset \Sigma$ we assign the *curve complex* $\mathcal{C}(Y)$. To two such subsurfaces Y, Z with $\partial Y \cap \partial Z \neq \emptyset$ (this means that the intersection is nonempty even after any isotopy) there is the Masur-Minsky *subsurface projection* $\pi_Y(Z) \subset \mathcal{C}(Y)$. We refer the reader to Section 5.1, where these notions are reviewed. More generally, when β is a simple closed curve that cannot be isotoped to be disjoint from Y , we have a projection $\pi_Y(\beta) \subset \mathcal{C}(Y)$. The mapping class group $MCG(\Sigma)$ acts on the product $\prod_Y \mathcal{C}(Y)$ and we have an orbit map

$$\Psi : MCG(\Sigma) \rightarrow \prod_Y \mathcal{C}(Y)$$

which is, as a *coarse map* (i.e. a point is mapped to a bounded set), more explicitly given by

$$\Psi(g) = (\pi_Y(g(\alpha)))_Y$$

where α is a finite *binding* collection of simple closed curves (see Section 5.4).

The remarkable Masur-Minsky distance formula (Theorem 6.12 in [MM00]) says that the word norm $|g|$ of $g \in MCG(\Sigma)$ is *coarsely equal* (i.e., up to a multiplicative and additive error) to

$$\sum_Y \{\{d_{\mathcal{C}(Y)}(\pi_Y(\alpha), \pi_Y(g(\alpha)))\}\}_M$$

where M is sufficiently large, and $\{\{x\}\}_M$ is defined as x if $x > M$ and as 0 if $x \leq M$. In [MM00] the distance formula is stated for the “marking graph”, which is quasi-isometric to the mapping class group, see [MM00, Section 7].

Morally, this formula says that Ψ is a quasi-isometric embedding. However, the product space is not a metric space (the “cut-off” distance is not a metric). More problematic, although we now have much information about the individual curve complexes, this embedding is in an infinite product which is difficult to work with.

In this paper, we use Theorem A to embed the mapping class group in a *finite* product of *quasi-trees of curve complexes*. To do so we show that essential subsurfaces can be grouped in finitely many subcollections $\mathbf{Y}^1, \mathbf{Y}^2, \dots, \mathbf{Y}^k$ so that the curve complexes of subsurfaces in each \mathbf{Y}^i satisfy (P0)-(P2) with respect to subsurface projections, thus yielding the quasi-tree of curve complexes $\mathcal{C}(\mathbf{Y}^i)$. Everything can be done equivariantly, so that we have an orbit map

$$MCG(\Sigma) \rightarrow \mathcal{C}(\mathbf{Y}^1) \times \mathcal{C}(\mathbf{Y}^2) \times \dots \times \mathcal{C}(\mathbf{Y}^k).$$

In each $\mathcal{C}(\mathbf{Y}^i)$ the distance is approximated by the Masur-Minsky formula restricted to the summands in $\mathcal{C}(\mathbf{Y}^i)$. Then the Masur-Minsky formula can be interpreted as saying that the map of $MCG(\Sigma)$ into the product of quasi-trees of curve complexes is a quasi-isometric embedding. The choice of an orbit for the map is not important. As each factor is hyperbolic we have the following theorem in Section 5:

Theorem C. *$MCG(\Sigma)$ equivariantly quasi-isometrically embeds in a finite product of hyperbolic spaces.*

The following result follows easily from the definition of *asymptotic cones* (see [BDS11b, BDS11a]).

Theorem. [Behrstock-Drutu-Sapir] *Every asymptotic cone of $MCG(\Sigma)$ embeds by a bi-Lipschitz map in a finite product of \mathbb{R} -trees.*

In fact they prove more including some information on the geometry of the image of the embedding, but their theorem does not imply Theorem C. They use the notion of *tree-graded space* introduced in [DrS].

We now make a few comments on verifying the axioms (P0)-(P2) in this setting, as this is the situation that crystallized the correct axiomatic approach. Axiom (P0) was established by Masur-Minsky as part of the subsurface projection setup and it follows easily from definitions. Axiom (P1) was established by Behrstock [Beh06] and we refer to it, and to Axiom (P1) in general, as *Behrstock's inequality*. Axiom (P2) is a consequence of the Theorem 4.6 and Lemma 4.2 in [MM00].

A central idea in [MM00] is the notion of a *hierarchy* and this is used in the verification of the axioms by Masur-Minsky and Behrstock. This is a powerful tool but it is complicated to define and difficult to use. Leininger gave a very simple, hierarchy free proof of (P1) (see [Mang10, Mang13]) and here we will show that (P2) also has a direct, hierarchy free proof (see Lemma 5.3). Using this we can show that our map of the mapping class group into the product of quasi-trees of curve complexes is a *coarse embedding* without any of the results of [MM00]. In particular, we obtain a hierarchy free proof of the lower bound in the Masur-Minsky formula. In fact, the proof of Theorem D below does not depend on the results [MM00] although the ideas of that paper are certainly central to our proof.

In [EMR] Eskin-Masur-Rafi give a unified approach, using Theorem C, to studying the large scale geometry of Teichmüller space with either the Teichmüller metric or the Weil-Petersson metric, or of the mapping class group with the word metric.

It is a theorem of Bell-Fujiwara [BelF08] that each curve complex has finite asymptotic dimension. More recently, Richard Webb [Web] found explicit bounds on the asymptotic dimension of curve complexes. His bound was improved to a linear bound by Bestvina-Bromberg [BB] by a different method. Thus from Theorems B and C we obtain the following theorem, which motivated this work (see Section 5):

Theorem D. *Let Σ be a closed orientable surface, possibly with punctures. Then $\text{asdim}(MCG(\Sigma)) < \infty$.*

As a consequence of the bounds on the asymptotic dimension of curve complexes mentioned above, it follows that $\text{asdim}(MCG(\Sigma))$ is bounded by

an exponential function in the complexity of the surface.

The *Coarse Baum-Connes conjecture* (for torsion free subgroups of finite index) and therefore the *Novikov conjecture* follows [Yu98], cf. [Roe03]. Various other statements that imply the Novikov conjecture were known earlier (see [Kid08, Ham09, BM08]). We note that Hume [Hum] improved this result and showed that $MCG(\Sigma)$ has finite *Assouad-Nagata dimension* (meaning that in the definition of asymptotic dimension the diameter of each set in the cover is bounded by a linear function of R) and quasi-isometrically embeds in a finite product of trees.

Theorem E. [Theorem 5.13, Theorem 5.14] *The Teichmüller space of Σ , with either the Teichmüller metric or the Weil-Petersson metric, has finite asymptotic dimension.*

Recall that the *translation length* $\tau(g)$ of an isometry $g : X \rightarrow X$ is

$$\tau(g) := \lim_{k \rightarrow \infty} \frac{d_X(x, g^k(x))}{k}$$

The limit exists and is independent of $x \in X$. We say the isometry is *hyperbolic* if $\tau(g) > 0$. When X is a quasi-tree an isometry with unbounded orbits necessarily has positive translation length, [Man06]. The following theorem uses the observation that the $MCG(\Sigma)$ -orbit of a curve in a surface of even genus that separates into subsurfaces of equal genus consists of pairwise intersecting curves.

Theorem F. *The mapping class groups in even genus can act on quasi-trees with a Dehn twist having unbounded orbits.*

See Theorem 5.9. In the case of odd genus one has to pass to a subgroup of finite index. It follows that each Dehn twist has linear growth in the word length in $MCG(\Sigma)$ (known by [FLM01]). Theorem F provides a sharp contrast to a result of Bridson [Bri10], who showed that in semi-simple actions of mapping class groups (of genus > 2) on complete CAT(0) spaces Dehn twists are always elliptic. A group action is *semi-simple* if each element has either a bounded orbit or positive translation length. In the CAT(0) case one gets a homomorphism from the centralizer of a Dehn twist to \mathbb{R} by looking at the action on the purported axis (identifying all *parallel* axes to one); in our quasi-tree setting a similar construction produces only a quasi-morphism on the centralizer. We say that two (quasi-)geodesics are *parallel* if their Hausdorff distance is finite. In genus > 2 the centralizer of a Dehn twist has no nontrivial homomorphisms to \mathbb{R} , but does admit many quasi-morphisms.

By a *thickening* of a metric space X we mean a quasi-isometric embedding $X \rightarrow Y$. When X is a graph with edges of length 1 and $d \geq 1$, there is a particular thickening $X \rightarrow P_d(X)$ called the *Rips complex* of X . The space $P_d(X)$ is a simplicial complex with the same vertex set as X and with simplices consisting of finite collections of vertices with pairwise distance at most d .

Theorem G. [Corollary 5.10] *There is an isometric action of a group on a graph X which is a quasi-tree such that no equivariant thickening admits an equivariant $CAT(0)$ metric. In particular, for no $d \geq 1$ does the Rips complex $P_d(X)$ admit an equivariant $CAT(0)$ metric.*

It is a long-standing open question whether every δ -hyperbolic group acts cocompactly and properly by isometries on a $CAT(0)$ space. One approach is to consider the Rips complex $P_d(X)$ for the Cayley graph X of the group and large d . Theorem G is not a counterexample to this approach since our X is not locally finite, but it does point out difficulties. Note that in light of [MSW03] the quasi-trees that arise in our construction are necessarily locally infinite, since otherwise we would be able to promote our group actions on quasi-trees to group actions on simplicial trees without fixed points, which is not possible for certain groups.

2.2 Hyperbolic-like groups

At the beginning of the introduction we indicated how a discrete group of isometries of \mathbb{H}^n that contains an element with an axis gives rise to data satisfying our axioms, and thus the same group acts on the quasi-tree of lines, which itself is a quasi-tree by Theorem B (ii).

The essential feature of this example is that the axis ℓ is *B-contracting* for some $B \geq 0$. This means that the nearest point projection to ℓ of any metric ball disjoint from ℓ has diameter bounded by B . See [BF09]. More generally, one can define the notion of *B-contracting* for any subset of a metric space using the nearest point projection to the subset.

To state the theorem, assume that a group G acts by isometries on a geodesic metric space X , that $\gamma \in G$ acts *hyperbolically* (i.e. any orbit map is a quasi-isometric embedding, or equivalently the translation length of γ is positive) and that γ is a WPD element [BF02], that is, for all $D > 0$ and $x \in X$ there exists $M > 0$ such that

$$\{g \in G \mid d(x, g(x)) \leq D, d(f^M(x), gf^M(x)) \leq D\}$$

is finite. We also say that two orbits are *parallel* if their Hausdorff distance is finite.

Theorem H. *Let G act on a geodesic metric space X such that $\gamma \in G$ is a hyperbolic WPD element with a B -contracting orbit. Then the collection of parallel classes of G -translates of a fixed γ -orbit (of a point) with nearest point projections satisfies (P0)-(P2) and thus G acts on a quasi-tree. In addition, in this action γ is a hyperbolic WPD element.*

In this form the theorem is proved in [BBFb]. We do not assume that X is hyperbolic nor CAT(0). The main part of the proof consists of verifying (P0)-(P2) and applying Theorem A in this situation. The rest is included as Proposition 4.20. Dahmani-Guirardel-Osin [DGO, Section 4.5] prove a variation of Theorem H where X is assumed to be hyperbolic and use it to construct many examples of *hyperbolically embedded subgroups* (see [DGO] for the definition).

Examples 2.1. The following examples all satisfy Theorem H. One considers the translates of an axis, or more generally the orbit of a point, of a hyperbolic WPD element.

- (1) G is a discrete group of isometries of \mathbb{H}^n that contains an element γ with an axis. γ is WPD since the action of G is properly discontinuous, and the axis is B -contracting since \mathbb{H}^n is δ -hyperbolic.
- (2) G is a group of isometries of a connected δ -hyperbolic graph X that contains a hyperbolic, therefore its (quasi-)axis is B -contracting, WPD element. In particular, this construction applies to the curve complex and the mapping class group of a compact surface, where pseudo-Anosov elements are hyperbolic and WPD [BF02]. This class of groups contains many groups with Kazhdan's property (T) and therefore every isometric action on a simplicial tree has a fixed point (cf. [dlHV89]).
- (3) G is a discrete group of isometries (i.e. the group action is metrically properly discontinuous) of a CAT(0)-space that contains a *rank 1 element* γ in the sense of Ballmann. That is, γ has an axis which is B -contracting for some $B \geq 0$. For example, pseudo-Anosov mapping classes are rank 1 elements in the action on the Weil-Petersson completion of Teichmüller space. In the cocompact setting this is equivalent to the more familiar condition that the axis does not bound a half-flat. Those elements are WPD although the action of the mapping class group is not properly discontinuous. See [BF09]. There are classifications of rank 1 elements in Coxeter groups [CF10], right angled Artin groups [BC12] and cube complexes [CS11].

- (4) G is the mapping class group, acting on Teichmüller space with Teichmüller metric, and γ is a pseudo-Anosov mapping class. By [Min96b] the axis of γ is B -contracting. It is WPD since the action is properly discontinuous.
- (5) $G = \text{Out}(F_n)$ acting on Culler-Vogtmann’s Outer space CV [CV86], equipped with the Lipschitz metric (which fails to be symmetric, see [AKB12]). The action is properly discontinuous. See [Vog02], [BV06], [Vog06] for more information on $\text{Out}(F_n)$ and Outer space. An element f of $\text{Out}(F_n)$ is *fully irreducible* if there are no conjugacy classes of proper free factors of F_n which are f -periodic. Such elements have axes in CV , see [Bes11]. In [AK11] Yael Algom-Kfir shows that there is $\nu > 0$ such that the projection of any translate $\gamma(X_i)$ to any nonparallel X_j is bounded by ν , and she also shows that the axes are B -contracting for some B . Even though the metric is not symmetric, axioms hold. Axioms (P0)-(P1) are explicitly verified in [AK11] and Axiom (P2) follows quickly from the arguments in [AK11], for details see [BBFb].

Remark 2.2. Suppose a group G acts on a geodesic space X with a hyperbolic element $g \in G$ with a g -orbit α . The *elementary closure*, $EC(g)$, of g is the subgroup of elements $h \in G$ such that $h(\alpha)$ is parallel to α . When X is δ -hyperbolic, $g \in G$ is a WPD element if and only if $EC(g)$ is virtually cyclic and for some (any) $x \in X$ there is $B > 0$ such that any $\phi \in G - EC(g)$ maps the orbit $\langle g \rangle x$ to a set whose projection to $\langle g \rangle x$ has diameter $\leq B$. In this setting the orbit is a quasi-geodesic and the projection is the nearest point projection, coarsely defined (see the comment before Corollary 4.10). Thus WPD is equivalent to saying that the set of translates of a g -orbit is “discrete” in the sense that any two are either parallel or have bounded “overlap”, with parallel orbits coming from translating by elements in $EC(g)$.

The work of Epstein-Fujiwara [EF97] implies that non-elementary (i.e. not virtually cyclic) hyperbolic groups have many unbounded actions on quasi-lines, i.e., geodesic spaces quasi-isometric to a line. Manning [Man05] gave a construction of an action of a group G on a quasi-tree starting with a quasi-morphism $G \rightarrow \mathbb{R}$ (equivalently, an action of G on a quasi-line) but it is not clear when such actions are non-elementary (i.e. have unbounded orbits and do not fix an end nor a pair of ends). A map $f : G \rightarrow \mathbb{R}$ is a *quasi-morphism* if there exists a constant C such that for all $g, h \in G$

$$|f(gh) - f(g) - f(h)| \leq C.$$

Recently, it has been verified that the actions by Manning are not elementary for certain cases using our work [MP12]. We will also verify that the non elementary groups in Example 2.1 have non elementary actions on quasi-trees (Corollary 3.25).

Recall that an isometric group action is *acylindrical* if for every $D > 0$ there exist $R, N > 0$ such that $d(x, y) \geq R$ implies that the set

$$\{g \in G \mid d(x, g(x)) \leq D, d(y, g(y)) \leq D\}$$

has cardinality at most N . Osin develops a theory of *acylindrically hyperbolic groups*: these are groups that admit a non-elementary acylindrical isometric action on a hyperbolic space.

Theorem I. (*Osin [Osi]*) *Let a group G , which is not virtually cyclic, act on a δ -hyperbolic metric space X such that $\gamma \in G$ is a hyperbolic WPD element. Then G is an acylindrically hyperbolic group. Thus all groups in Examples 2.1 are acylindrically hyperbolic.*

From the point of view of this paper, Osin considers a slightly different projection distance $d_Y(x, z)$ (within uniformly bounded distance of ours) which is better behaved, so that the action on the resulting quasi-tree of metric spaces $\mathcal{C}(\mathbf{Y})$ constructed in exactly the same way, but with each copy $Y \in \mathbf{Y}$ *electrified* (i.e., any two points in Y is joined by an edge of length 1), is acylindrical.

Caprace and Delzant pointed out the following curious corollary. Recall that Burger-Mozes [BuM00] constructed an example of a simple group, which acts freely and cocompactly on the product of two trees. Thus the quotient is a finite non-positively curved square complex with finitely-presented, infinite simple fundamental group.

Corollary 2.3 (Caprace-Delzant). *Suppose Z is a finite non-positively curved square complex with no free edges whose fundamental group is simple. Then the universal cover \tilde{Z} is isometric to the product of two trees.*

Proof. By the Ballmann-Brin Rank Rigidity Theorem [BaBr, Th C] (see also [CS11]) the universal cover \tilde{Z} is either the product of two trees or the deck group contains a rank 1 element (there is a third possibility in general that \tilde{Z} is a Euclidean building, which we can exclude since Z is a square complex). In the latter case, using Theorem H, we see that $\pi_1(Z)$ acts on a quasi-tree and contains a hyperbolic WPD element γ . $\pi_1(Z)$ is non elementary since it is simple and torsion-free. Then by the work of Dahmani-Guirardel-Osin [DGO] the normal closure of γ^m is a free group when $m > 0$ is sufficiently

large, so $\pi_1(Z)$ is not simple. (The result of [DGO, Section 5 and 6] applies to a hyperbolic WPD element γ that acts on a hyperbolic space.) \square

2.3 Bounded cohomology

As we said Manning [Man05] used bounded cohomology/quasi-morphisms to show that many groups acted on quasi-trees. Conversely, the existence of actions of a group on a quasi-tree (with a hyperbolic WPD element) has a consequence that the second bounded cohomology (even with coefficients in certain representations) is “big”. One can use such actions to give unified constructions of quasi-morphisms on various groups G , and even quasi-cocycles with coefficients in unitary representations in uniformly convex Banach spaces. The case of the regular representation on $\ell^2(G)$ is of particular importance (see [Mon06]). We investigate this in [BBFa].

In fact, Theorem H can be regarded as a completion of Manning’s program [Man05] showing that all (known) groups with big second bounded cohomology admit (many) interesting actions on quasi-trees.

By contrast, there are many groups that do not admit nontrivial (namely, orbits are unbounded) actions on a quasi-tree. Recall [Man06] that a group G satisfies QFA if every action on a quasi-tree has bounded orbits. Equivalently (see e.g. [Man05]) every quasi-action on a tree has bounded orbits. If G is an irreducible lattice in a higher rank semi-simple Lie group with finite center, it is expected that G has QFA. For $SL_n(\mathbb{Z})$, $n \geq 3$, this is a result of Manning [Man06].

Developing Theorem E further and using Theorem H, in [BBFc] we construct bounded cohomology classes that are unbounded on powers of a Dehn twist. In fact, expanding on this idea we give a precise characterization of mapping classes that have nonzero stable commutator length.

2.4 $Out(F_n)$

There is a program to prove Theorem D and a version of Theorem C for the outer automorphism group $Out(F_n)$ of a free group F_n of rank n . There are (at least) two analogs of the curve complex, namely the complex of free factors and the complex of free splittings. Both have recently been shown to be hyperbolic, the former in [BFe14a] and the latter in [HM13]. The analog of subsurface projections was defined in [BFe14b] and the end result is

Theorem J. *[BFe14b] $Out(F_n)$ acts isometrically on a finite product of hyperbolic spaces so that every element of exponential growth acts with positive translation length.*

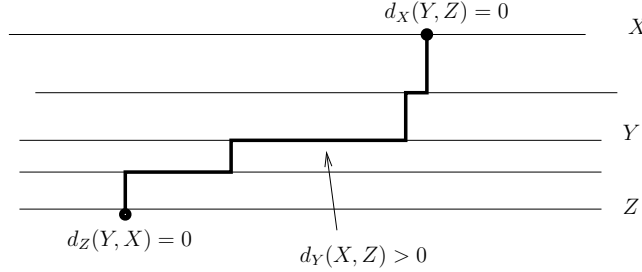

Figure 2: Axiom (P1) for the set of horizontal lines in the Cayley tree. The bold line is the shortest segment between X and Z

See [MS13], [FPS], [Sis], [Del] for further applications of the projection complex techniques.

2.5 The tree example

Let $F_2 = \langle a, b \rangle$ be the free group on two generators. Embed its Cayley graph (tree) in \mathbb{R}^2 such that the a edges are horizontal and the b edges are vertical. The horizontal lines are the axes of a and its conjugates and we let \mathbf{Y} be the set of horizontal lines. Note that if X and Y are in \mathbf{Y} then $\pi_Y(X)$, the nearest point projection of X to Y , is a single point, and we have (P0). Then $d_Y^\pi(X, Z)$ is the diameter of the union of $\pi_Y(X)$ and $\pi_Y(Z)$ which is of course just the distance between the two points.

In this example it is quite easy to check that the axioms hold. We first note that to calculate $d_Y^\pi(X, Z)$ we take the unique shortest segment in the Cayley tree from X to Z . If this segment intersects Y then the intersection will be a closed segment one endpoint of which is $\pi_Y(X)$ and the other is $\pi_Y(Z)$. Then $d_Y^\pi(X, Z)$ will be the length of the intersection. If the segment from X to Z doesn't intersect Y then we will have $\pi_Y(X) = \pi_Y(Z)$ and $d_Y^\pi(X, Z) = 0$. Therefore if $d_Y^\pi(X, Z) > 0$ then $d_X^\pi(Y, Z) = d_Z^\pi(Y, Z) = 0$ which is exactly (P1) where $\theta = 0$. For (P2) we note that the elements of \mathbf{Y} are all disjoint in the Cayley graph and therefore if the segment from X to Z has length D then there are at most D/K elements $Y \in \mathbf{Y}$ with $d_Y(X, Z) > K$ for any $K > 0$. (Notice that in the Cayley tree, $d_Y(X, Z) \geq 1$ if $d_Y(X, Z) > 0$.)

We now define the projection complex $\mathcal{P}_K(\mathbf{Y})$ in this special case. Fix a constant $K > 0$. The vertex set is \mathbf{Y} . Two distinct vertices X, Y are joined by an edge if and only if for every $Z \in \mathbf{Y}$ with $X \neq Z \neq Y$ we have $d_Z^\pi(X, Y) \leq K$.

the segment. With this ordering it is easy to check that this set is a path, γ , from X to Y in $\mathcal{P}_K(\mathbf{Y})$. Proposition 3.14 we just discussed implies that any path $\{X_0 = X, X_1, \dots, X_k = Y\}$ must go within distance one of every vertex $Z \in \mathbf{Y}_K(X, Z)$ for if not $\pi_Y(X) = \pi_Y(Z)$ and $d_Z(X, Y) = 0 \not\geq K$, a contradiction. Hence, Manning's bottleneck criterion holds for the path γ with the constant 2 and $\mathcal{P}_K(\mathbf{Y})$ is a quasi-tree.

Notice that the element $a^n b^n$ is hyperbolic in $\mathcal{P}_K(\mathbf{Y})$ when $K < n$ (cf. Lemma 3.22) and it has bounded orbits when $K \geq n$. Thus for $K < K'$ the natural map $\mathcal{P}_K(\mathbf{Y}) \rightarrow \mathcal{P}_{K'}(\mathbf{Y})$ is Lipschitz but in general it is not a quasi-isometry.

Also note that $\mathcal{P}_K(\mathbf{Y})$ is not locally finite; the infinite set of horizontal lines that intersect a fixed vertical line are all connected to each other in pairs.

2.6 Plan of the paper

We now briefly indicate the highlights of each section of the paper.

Section 3. We define the projection complex starting from the axioms. An important technicality is that we have to perturb the initial pseudo-distance function d^π by a bounded amount to a new function d in order to achieve a certain Monotonicity Property. The main properties of this perturbed distance are listed in Theorem 3.3. Perhaps the most important property is that the finite set in axiom (P2) has a natural total order; this is motivated by the Masur-Minsky hierarchy machinery.

Next, we focus on proving that the projection complex is a quasi-tree (Theorem 3.16). Roughly speaking, the proof follows the argument for the tree example in section 2.5. There is a significant technical point here. When the constant θ is positive, there is no reason that the projections of the X_i to Z are all the same point, but instead they might be slowly making progress along Z . In order to rule this possibility out we introduce the notion of a *guard* and a closely related notion of a *barrier*. In order for the sequence X_i to make progress in Z , it first has to do so in a suitable guard. When it looks like the given guard has been cleared, another one appears that also must be cleared before any progress in Z is made, etc. See Lemma 3.12 and Proposition 3.14. In the Cayley tree example, W is a barrier. We also record an upper and a lower bound on the distance in the projection complex in the spirit of the Masur-Minsky distance formula. See Proposition 3.7 and Lemma 3.18. We end the section with the study of the basic properties of the group action on the projection complex, including WPD (see Remark 3.28).

Section 4. We define the quasi-tree of metric spaces $\mathcal{C}(\mathbf{Y})$, which depends on a constant $K > 0$, essentially by blowing up each vertex of the projection complex to the associated metric space. In the Cayley tree example, we replace (blow up) the vertex for each horizontal line by the horizontal line itself. To say it differently, we take the disjoint union of the given collection of metric spaces and we attach edges from every point of $\pi_Y(Z)$ to every point of $\pi_Z(Y)$ provided that the projection distance $d_W(Y, Z)$ does not exceed some threshold K for all $W \neq Y, Z$. We then develop the basic geometry of $\mathcal{C}(\mathbf{Y})$. We prove the distance formula, analogous to Masur-Minsky's, in Theorem 4.13. We also show that the nearest point projection of Z to Y in $\mathcal{C}(\mathbf{Y})$ coarsely agrees (i.e. in bounded Hausdorff distance) with the given set $\pi_Y(Z)$. This will prove Theorem A. Technically, the proofs consist of lifting the notions of guards and barriers from the projection complex to $\mathcal{C}(\mathbf{Y})$.

We then proceed by to prove that various properties that hold for each $Y \in \mathbf{Y}$ uniformly continue to hold for $\mathcal{C}(\mathbf{Y})$ in Section 4.3. This includes hyperbolicity, being a quasi-tree, having bounded asymptotic dimension, and quasi-convexity. In particular, this will prove Theorem B. For example, in the Cayley tree example, $\mathcal{C}(\mathbf{Y})$ is a quasi-tree. Lastly in Section 4.4, for the purposes of [BBFc] we also discuss a certain property of the group action, called WWPD, which is weaker than WPD.

Section 5. This section is focused on the mapping class group and here we prove all the other theorems stated in the introduction. Subsurface projections are defined only for subsurfaces whose boundaries intersect. The main technical issue we have to address is how to divide the collection of all subsurfaces into finitely many families so that within each family subsurface projections are well defined. This problem is quickly reduced to showing that the curve graph (i.e. the 1-skeleton of the curve complex) has finite coloring. We in fact show that there exist such a coloring so that the mapping class group acts by permuting the colors. The finite index subgroup that preserves all colors has the property that for each of its elements g and every curve a , either $g(a) = a$ or $g(a)$ and a intersect. See Lemmas 5.6 and 5.7.

3 The projection complex

We start by introducing the projection complex. To define it we don't really need the projections $\pi_A(B)$ as in axioms (P0)-(P2); we only need the pseudo-distance $d_{\mathcal{C}}^{\pi}(A, B)$. Accordingly the axioms are weakened.

3.1 Projection complex axioms

Let \mathbf{Y} be a set, $\theta \geq 0$ a constant and assume that for each $Y \in \mathbf{Y}$ we have a function

$$d_Y^\pi : (\mathbf{Y} \setminus \{Y\}) \times (\mathbf{Y} \setminus \{Y\}) \longrightarrow [0, \infty).$$

The *projection complex axioms* are the following:

(PC 1) $d_Y^\pi(X, Z) = d_Y^\pi(Z, X)$;

(PC 2) $d_Y^\pi(X, Z) + d_Y^\pi(Z, W) \geq d_Y^\pi(X, W)$ (triangle inequality);

(PC 3) $\min\{d_Y^\pi(X, Z), d_Z^\pi(X, Y)\} \leq \theta$;

(PC 4) for all $X, Z \in \mathbf{Y}$, $\#\{Y \mid d_Y^\pi(X, Z) > \theta\}$ is finite.

As an analog of uniform boundedness of the projections $\pi_Y(Z)$ we could require that $d_Y^\pi(Z, Z) \leq \theta$, but this will not be used in the sequel.

3.2 Monotonicity

Given distance functions that satisfy the above axioms it is useful to modify them by a bounded amount in order to achieve the Monotonicity property (F) of Theorem 3.3. See Remark 3.4 for an example where (F) fails. The price we will have to pay is that triangle inequality will hold only up to a bounded error.

The following definition is motivated by the Masur-Minsky hierarchy theory.

Definition 3.1. For $X, Z \in \mathbf{Y}$ with $X \neq Z$ let $\mathcal{H}(X, Z)$ to be the set of pairs $(X', Z') \in \mathbf{Y} \times \mathbf{Y}$ with $X' \neq Z'$ such that one of the following four holds:

- both $d_X^\pi(X', Z'), d_Z^\pi(X', Z') > 2\theta$;
- $X = X'$ and $d_Z^\pi(X, Z') > 2\theta$;
- $Z = Z'$ and $d_X^\pi(X', Z) > 2\theta$;
- $(X', Z') = (X, Z)$.

We can now define the modified distance functions

$$d_Y : (\mathbf{Y} \setminus \{Y\}) \times (\mathbf{Y} \setminus \{Y\}) \rightarrow [0, \infty)$$

by

$$d_Y(X, Z) = 0$$

if Y is contained in a pair in $\mathcal{H}(X, Z)$ and

$$d_Y(X, Z) = \inf_{(X', Z') \in \mathcal{H}(X, Z)} d_Y^\pi(X', Z')$$

otherwise. For example, if $d_Y^\pi(W, Z) > 2\theta$, then $(W, Z) \in \mathcal{H}(Y, Z)$ and $d_W(Y, Z) = 0$.

Note that it is clear from the definition that $d_Y(X, Z) \leq d_Y^\pi(X, Z)$ and therefore (PC 3) still holds for d_Y with the same constant. However we need to modify (PC 2) to a coarse triangle inequality.

Proposition 3.2. *If $(X', Z') \in \mathcal{H}(X, Z)$ then for every $Y \in \mathbf{Y}$, $Y \notin \{X, Z, X', Z'\}$ we have*

$$d_Y^\pi(X, Z) - d_Y^\pi(X', Z') \leq 2\theta.$$

Proof. If $d_Y^\pi(X, Z) \leq 2\theta$ we are done since the distances are always nonnegative. We note that if Y is contained in a pair in $\mathcal{H}(X, Z)$ then $d_Y^\pi(X, Z) \leq 2\theta$ by an application of (PC 2) and (PC 3). For the rest of the proof we now assume that $d_Y^\pi(X, Z) > 2\theta$ and in particular that Y is not contained in a pair in $\mathcal{H}(X, Z)$.

We first assume that X and Z are distinct from X' and Z' . By the triangle inequality

$$d_X^\pi(X', Y) + d_X^\pi(Y, Z') \geq d_X^\pi(X', Z') > 2\theta$$

and therefore

$$\max\{d_X^\pi(X', Y), d_X^\pi(Y, Z')\} > \theta.$$

Without loss of generality we assume that $d_X^\pi(X', Y) > \theta$.

By (PC 3) we have $d_Y^\pi(X, X') \leq \theta$ and again applying the triangle inequality we have

$$d_Y^\pi(X, X') + d_Y^\pi(X', Z) \geq d_Y^\pi(X, Z) > 2\theta$$

and therefore

$$d_Y^\pi(X', Z) > 2\theta - \theta = \theta.$$

Another application of (PC 3) gives us that $d_Z^\pi(X', Y) \leq \theta$.

We now apply the triangle inequality exactly as we did at the start of the proof but replacing X with Z . Again we get that

$$\max\{d_Z^\pi(X', Y), d_Z^\pi(Z', Y)\} > \theta$$

and since we have just seen that $d_Z^\pi(X', Y) \leq \theta$ we must have $d_Z^\pi(Z', Y) > \theta$. Then by (PC 3), $d_Y^\pi(Z, Z') \leq \theta$.

To finish the proof in this case we make one final application of the triangle inequality to see that

$$d_Y^\pi(X, X') + d_Y^\pi(X', Z') + d_Y^\pi(Z', Z) \geq d_Y^\pi(X, Z)$$

and therefore

$$d_Y^\pi(X, Z) - d_Y^\pi(X', Z') \leq 2\theta.$$

For pairs of the form (X', Z) with $X' \neq X$ the proof is easier. As before we have the inequality

$$d_X^\pi(X', Y) + d_X^\pi(Y, Z) \geq d_X^\pi(X', Z) > 2\theta.$$

Since $d_Y^\pi(X, Z) > 2\theta$ we must have $d_X^\pi(Y, Z) \leq \theta$ and therefore $d_X^\pi(X', Y) > \theta$ and $d_Y^\pi(X, X') \leq \theta$. We once again apply the triangle inequality to see that

$$d_Y^\pi(X, X') + d_Y^\pi(X', Z) \geq d_Y^\pi(X, Z)$$

and therefore

$$d_Y(X, Z) - d_Y(X', Z) \leq \theta \leq 2\theta.$$

The statement is trivial if $(X', Z') = (X, Z)$ so the proof is finished. \square

This result has number of important consequences. Before stating them we set notation that helps prevent a proliferation of constants. Given a constant $\theta \geq 0$, we say that $x \succ y$ or $y \prec x$ if $y - x$ is bounded above by a constant depending only on θ . We also define $x \sim y$ if $x \succ y$ and $y \succ x$. For example (PC 3) implies

$$\min\{d_Y(X, Z), d_Z(X, Y)\} \sim 0.$$

Thus, for the purposes of this notation, we regard θ as a variable that depends on the particular setting. Note that transitivity holds, i.e. if $x \succ y$ and $y \succ z$ then $x \succ z$, but the constant bounding $z - x$ is worse. Thus it is important to ensure that transitivity is applied only to chains of bounded length.

Next for a constant $K > 0$ we define $\mathbf{Y}_K(X, Z)$ to be the set of $Y \in \mathbf{Y}$ such that $d_Y(X, Z) > K$.

Here are the properties of the functions d_Y , gathered together in one theorem. One can think of them as axioms.

Theorem 3.3. *There exists a $\Theta > 0$, depending only on θ , such that the following properties hold:*

(A) **Symmetry**

$$d_Y(X, Z) = d_Y(Z, X)$$

(B) **Coarse equality** *For all distinct X, Y and Z*

$$d_Y^\pi(X, Z) \prec d_Y(X, Z) \leq d_Y^\pi(X, Z).$$

(C) **Coarse triangle inequality**

$$d_Y(X, Z) + d_Y(Z, W) \succ d_Y(X, W).$$

(D) **Inequality on triples**

$$\min\{d_Y(X, Z), d_Z(X, Y)\} \sim 0$$

(E) **Finiteness** $\#\{Y \mid d_Y(X, Z) \geq \Theta\}$ *is finite for all $X, Z \in \mathbf{Y}$.*

(F) **Monotonicity** *If $d_Y(X, Z) \geq \Theta$ then both $d_W(X, Y), d_W(Z, Y) \leq d_W(X, Z)$.*

(G) **Order** *The set $\mathbf{Y}_\Theta(X, Z) \cup \{X, Z\}$ is totally ordered with least element X and greatest element Z such that given $Y_0, Y_1, Y_2 \in \mathbf{Y}_\Theta(X, Z) \cup \{X, Z\}$, if $Y_0 < Y_1 < Y_2$ then*

$$d_{Y_1}(X, Z) \prec d_{Y_1}(Y_0, Y_2) \leq d_{Y_1}(X, Z),$$

and

$$d_{Y_0}(Y_1, Y_2) \sim 0 \text{ and } d_{Y_2}(Y_0, Y_1) \sim 0.$$

(H) **Barrier property** *If $Y \in \mathbf{Y}_\Theta(X_0, Z)$ and $Y \in \mathbf{Y}_\Theta(X_1, Z)$ then*

$$d_Z(X_0, X_1) < \Theta.$$

Proof. For each property we will see that there is some constant Θ so that the property holds for any larger choice of constant. Therefore, in the proof of each property, we will use the properties we have already showed. Throughout the proof one should think of θ as being fixed but Θ as a variable that won't be fixed until the end of the proof.

(A) - (E). The symmetry property follows from the symmetry property for d_Y^π and the definition of d_Y . The coarse equality property is just a restatement of Proposition 3.2 with our new notation. The coarse triangle inequality, the inequality on triples and the finiteness property all follow from the corresponding properties for d_Y^π plus coarse equality. Note that the inequality on triples and the finiteness property hold for any $\Theta \geq \theta$. This will be important in the proof of the order property.

(F). The monotonicity property requires a bit of work. We show that for any $\Theta > 4\theta$ if $Y \in \mathbf{Y}_\Theta(X, Z)$ then

$$\mathcal{H}(X, Z) \subseteq \mathcal{H}(X, Y) \cap \mathcal{H}(Z, Y).$$

If $(X', Z') \in \mathcal{H}(X, Z)$ then by Proposition 3.2 we have

$$d_Y^\pi(X, Z) - d_Y^\pi(X', Z') \leq 2\theta$$

and since $d_Y^\pi(X, Z) \geq d_Y(X, Z) \geq \Theta > 4\theta$ we have $d_Y^\pi(X', Z') > 2\theta$. In particular (X', Z') is in both $\mathcal{H}(X, Y)$ and $\mathcal{H}(Z, Y)$ and the inequalities follow. We have showed that the monotonicity holds for any constant $> 4\theta$.

(G). The proof of the order property is more involved. Let $W, Y \in \mathbf{Y}_\Theta(X, Z)$. Using the inequality on triples we choose θ' with $4\theta < \theta' \sim 0$ such that (for any X, Y, Z) $\min\{d_Y(X, Z), d_Z(X, Y)\} \leq \theta'$.

To define the order we first establish that if Θ is sufficiently large then the following are equivalent.

- (a) $d_W(X, Y) > \theta'$;
- (b) $d_Y(X, W) \leq \theta'$;
- (c) $d_Y(W, Z) > \theta'$;
- (d) $d_W(Y, Z) \leq \theta'$.

Both (a) \Rightarrow (b) and (c) \Rightarrow (d) follow from the inequality on triples. For (b) \Rightarrow (c) we apply the coarse triangle inequality to see that

$$d_Y(X, W) + d_Y(W, Z) \succ d_Y(X, Z) > \Theta,$$

so if $d_Y(X, W) \leq \theta'$ then $d_Y(W, Z) \succ \Theta$. In particular if Θ is sufficiently large then $d_Y(W, Z) > \theta' > 4\theta$. By swapping W and Y this also shows that (d) \Rightarrow (a).

We now define $W < Y$ if any, and hence all, of (a) - (d) hold. Since either $d_W(X, Y) > \theta'$ or $d_W(X, Y) \leq \theta'$ (but not both) we must have either

$W < Y$ or $Y < W$ (but not both). To finish the definition of the order we define X to be the least element and Z the greatest element. We have just shown that any two elements can be compared and that if $Y < W$ then $W \not< Y$.

To argue transitivity, assume that $Y_0 < Y_1 < Y_2$. We assume $Y_0 \neq X$ and $Y_2 \neq Z$ since if either is held then the rest of the proof is easier and we omit it. As noted at the end of its proof, the monotonicity holds for any constant $> 4\theta$, instead of Θ , in particular for θ' . Since $Y_1 < Y_2$ we have $d_{Y_1}(X, Y_2) > \theta' > 4\theta$ and therefore monotonicity (with respect to θ') implies that

$$\theta' < d_{Y_0}(X, Y_1) \leq d_{Y_0}(X, Y_2),$$

so $Y_0 < Y_2$ and transitivity holds.

We now prove the two inequalities (\prec and \leq). Since $Y_0 < Y_2$ and therefore $d_{Y_0}(X, Y_2) > 4\theta$ monotonicity (for θ') also implies that

$$d_{Y_1}(Y_0, Y_2) \leq d_{Y_1}(X, Y_2).$$

Since $Y_2 \in \mathbf{Y}_\Theta(X, Z)$ we also have that $d_{Y_2}(X, Z) > 4\theta$ (if $\Theta \geq 4\theta$). Therefore, again, monotonicity implies that

$$d_{Y_1}(X, Y_2) \leq d_{Y_1}(X, Z)$$

and together these two inequalities give

$$d_{Y_1}(Y_0, Y_2) \leq d_{Y_1}(X, Z).$$

By the coarse triangle inequality we have

$$d_{Y_1}(X, Y_0) + d_{Y_1}(Y_0, Y_2) + d_{Y_1}(Y_2, Z) \succ d_{Y_1}(X, Z).$$

Since $Y_0 < Y_1$ and $Y_1 < Y_2$, we have $d_{Y_1}(X, Y_0) \leq \theta'$ and $d_{Y_1}(Y_2, Z) \leq \theta'$. It follows that

$$d_{Y_1}(Y_0, Y_2) \succ d_{Y_1}(X, Z).$$

Finally, to see the two claims with \sim , we note that if Θ is sufficiently large than the last coarse inequality implies that $d_{Y_1}(Y_0, Y_2) > \theta$ so the inequality on triples implies that

$$d_{Y_0}(Y_1, Y_2) \leq \theta \text{ and } d_{Y_2}(Y_0, Y_1) \leq \theta$$

which implies both are ~ 0 .

(H). Finally we prove the barrier property. If the conclusion fails, i.e. if $d_Z(X_0, X_1) \geq \Theta$ then $Z \in \mathbf{Y}_\Theta(X_0, X_1)$ and also, by monotonicity, $Y \in \mathbf{Y}_\Theta(X_0, X_1)$. If $Y < Z$ in $\mathbf{Y}_\Theta(X_0, X_1)$ then $d_Y(X_1, Z) \leq \theta$ and if $Z < Y$ then $d_Y(X_0, Z) \leq \theta$. Either way, we have a contradiction. \square

Remark 3.4. The monotonicity property fails for the original distance d^π . Below is an example in the setting of geodesics in \mathbb{H}^2 (see Example 2.1(1)).

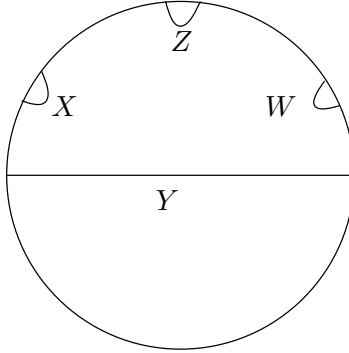

In the figure, $d_Y^\pi(X, Z)$ can be made arbitrarily large, while $d_W^\pi(Y, Z)$ is slightly larger than $d_W^\pi(X, Z)$. But if $d_Y^\pi(X, Z) > 2\theta$, then $(X, Z) \in \mathcal{H}(Y, Z)$, therefore $d_W(Y, Z) \leq d_W^\pi(X, Z)$.

One could define in the same way an order on $\mathbf{Y}_K(X, Z) \cup \{X, Z\}$ for any $K \geq \Theta$, but this order coincides with the induced order from the larger set $\mathbf{Y}_\Theta(X, Z) \cup \{X, Z\}$. The order on $\mathbf{Y}_K(Z, X) \cup \{Z, X\}$ is the reverse of the order on (the same set) $\mathbf{Y}_K(X, Z) \cup \{X, Z\}$.

The following lemma is a consequence of the monotonicity property.

Lemma 3.5. *There exists a $K > 0$ with $K \prec \Theta$ such that the following holds. Let $\{Y_0, \dots, Y_n\}$ be vertices in \mathbf{Y} such that $d_{Y_i}(Y_{i-1}, Y_{i+1}) > K$ for $i = 1, \dots, n-1$. Then for each i , $d_{Y_i}(Y_{i-1}, Y_{i+1}) \leq d_{Y_i}(Y_0, Y_n)$.*

Proof. We will show that $d_{Y_i}(Y_{i-1}, Y_{i+1}) \leq d_{Y_i}(Y_{i-1}, Y_{i+2})$. The lemma will then follow via an inductive argument. By the inequality on triples $d_{Y_{i+1}}(Y_{i-1}, Y_i) \sim 0$. The coarse triangle inequality implies $d_{Y_{i+1}}(Y_{i-1}, Y_{i+2}) \succ K$ so if K is sufficiently large we have that $d_{Y_{i+1}}(Y_{i-1}, Y_{i+2}) > \Theta$. The monotonicity implies that $d_{Y_i}(Y_{i-1}, Y_{i+1}) \leq d_{Y_i}(Y_{i-1}, Y_{i+2})$. \square

3.3 The projection complex

Unless otherwise said Θ is the constant from Theorem 3.3. For $K \geq \Theta$ we now define the projection complex $\mathcal{P}_K(\mathbf{Y})$. We always assume $K \geq \Theta$.

Definition 3.6. The *projection complex* $\mathcal{P}_K(\mathbf{Y})$ is the following graph. The vertex set of $\mathcal{P}_K(\mathbf{Y})$ is \mathbf{Y} . Two distinct vertices X and Z are connected with an edge if $\mathbf{Y}_K(X, Z)$ is empty. Denote the distance function for this graph by $d(\cdot, \cdot)$.

In particular $d(X, Z) = 1$ if $\mathbf{Y}_K(X, Z) = \emptyset$. Note that for different values of K the spaces $\mathcal{P}_K(\mathbf{Y})$ are not necessarily quasi-isometric to each other (the vertex sets are the same, but for larger K there are more edges, see Section 2.5 for an explicit example). Our goal is to show that $\mathcal{P}_K(\mathbf{Y})$ is quasi-isometric to a tree. We begin by showing that $\mathcal{P}_K(\mathbf{Y})$ is connected and obtain an upper bound on the distance function.

Proposition 3.7. *If X and Z are vertices in \mathbf{Y} then $d(X, Z) \leq |\mathbf{Y}_K(X, Z)| + 1$. In particular, $\mathcal{P}_K(\mathbf{Y})$ is connected.*

Proof. Label the elements of $\mathbf{Y}_K(X, Z) \cup \{X, Z\}$ by Y_0, Y_1, \dots, Y_{k+1} where the indices respect the order and $k = |\mathbf{Y}_K(X, Z)|$. We claim that $X = Y_0, Y_1, \dots, Y_{k+1} = Z$ is a path from X to Z . To see this we note that the monotonicity property implies that if $Y \in \mathbf{Y}_K(Y_i, Y_{i+1})$ then $Y \in \mathbf{Y}_K(X, Z)$ and $Y = Y_j$. However, since Y_j cannot be between Y_i and Y_{i+1} we have $d_{Y_j}(Y_i, Y_{i+1}) < \Theta$, a contradiction. Therefore $\mathbf{Y}_K(Y_i, Y_{i+1}) = \emptyset$, $d(Y_i, Y_{i+1}) = 1$ and we have our path from X to Z . \square

3.4 Guards

By contrast to Proposition 3.7, the cardinality of $\mathbf{Y}_K(X, Z)$ gives no lower bound on $d(X, Z)$. For example, it is possible that $\mathbf{Y}_K(Y_1, Z) = \emptyset$ and therefore the distance from X to Z is two (even though k is large). This highlights a key difficulty in the paper. From the viewpoint of X , there appear to be many projections larger than the K -threshold between Y_1 and Z . However, from the viewpoint of Y_1 there are no large projections between Y_1 and Z .

A key concept in the paper is the notion of a *guard* and this notion is defined to deal with this problem. The notion depends on the constant K . Roughly speaking, W is a guard for Y if from every viewpoint there are no large projections between W and Y .

Definition 3.8. $W \in \mathbf{Y}$ is a *guard* for Y if for every vertex $X \in \mathbf{Y}$ with $W \in \mathbf{Y}_\Theta(X, Y)$ and every $Z \in \mathbf{Y}_K(X, Y) \subset \mathbf{Y}_\Theta(X, Y)$ then $Z \leq W$.

Note that if W is a guard for Y then $d(W, Y) = 1$.

Lemma 3.9. *For K sufficiently large and vertices X, Y, Z and W , if $W \in \mathbf{Y}_\Theta(X, Y)$, $Z \in \mathbf{Y}_K(X, Y)$ and $W < Z$ in $\mathbf{Y}_\Theta(X, Y)$, then $Z \in \mathbf{Y}_{K/2}(W, Y)$.*

In particular, if $\mathbf{Y}_{K/2}(W, Y) = \emptyset$ then W is a guard for Y .

Proof. Given X, Y, Z and W as above, by the order property we have

$$d_Z(W, Y) \succ d_Z(X, Y) > K$$

and therefore if K is sufficiently large then

$$d_Z(W, Y) > K/2.$$

□

Note that it follows from this lemma and the order property that the least element of $\mathbf{Y}_{K/2}(X, Z)$ (if nonempty) is a guard for X and the greatest element is a guard for Z .

By definition, if X_0, X_1 are vertices adjacent in $\mathcal{P}_K(\mathbf{Y})$ then the projection, $d_W(X_0, X_1)$, to another vertex W will be bounded above by K . However, if W is distance two or more from one of X_0, X_1 , we get a stronger bound.

Lemma 3.10. *Let X_0 and X_1 be adjacent vertices in $\mathcal{P}_K(\mathbf{Y})$ and assume W is a vertex in \mathbf{Y} with $d(X_0, W) \geq 2$. Then*

$$d_W(X_0, X_1) \sim 0$$

and

$$d_W(X_0, Z) \sim d_W(X_1, Z)$$

for all $Z \in \mathbf{Y}$.

By our convention, the constants for the notation “ \sim ” in the statement do not depend on X_0, X_1, W, Z , but only on θ (and Θ).

Proof. Since $d(X_0, W) \geq 2$ there exists $Y \in \mathbf{Y}_K(X_0, W)$. If $d_W(X_0, X_1) > \Theta$ then by monotonicity we have

$$d_Y(X_0, X_1) \geq d_Y(X_0, W) > K$$

which contradicts $d(X_0, X_1) = 1$ and therefore $d_W(X_0, X_1) \leq \Theta$.

Applying the coarse triangle inequality we have

$$d_W(Z, X_0) + d_W(X_0, X_1) \succ d_W(Z, X_1)$$

which implies half of the second inequality. The other half is proved by swapping X_0 and X_1 . □

Remark 3.11. The estimate $d_W(X_0, X_1) \sim 0$ in Lemma 3.10 is the key place where we use monotonicity. In particular $d_W(X_0, X_1)$ is bounded by a constant that doesn't depend on K . Without monotonicity we would only have $d_W(X_0, X_1) \leq K$ which is by definition true for any adjacent vertices

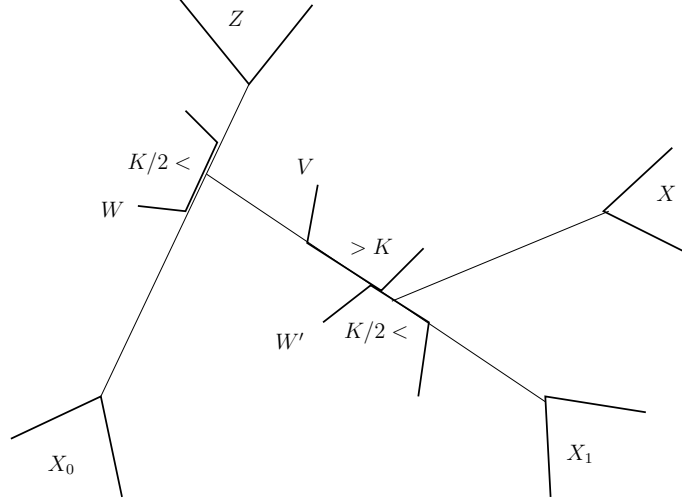

Figure 4: Lemma 3.12

X_0 and X_1 in $\mathcal{P}_K(\mathbf{Y})$. The other places where monotonicity is used, it is only for convenience to simplify the argument. The estimate in Lemma 3.10 is essential for what follows. Remark 3.17 gives an example of what can go wrong.

Lemma 3.12. *If K is sufficiently large the following holds. Let X_0 and X_1 be adjacent vertices with $d(X_i, Z) \geq 3$. Let W be a guard for Z such that $W \in \mathbf{Y}_{K/2}(X_0, Z)$. If $W \notin \mathbf{Y}_{K/2}(X_1, Z)$ then there exists a guard W' for Z such that $W' \in \mathbf{Y}_{K/2}(X_1, Z)$ and $W \in \mathbf{Y}_\Theta(W', Z)$.*

Proof. We assume that $W \notin \mathbf{Y}_{K/2}(X_1, Z)$. Note that $d(W, Z) = 1$ and since $d(X_0, Z) \geq 3$ we have $d(X_0, W) \geq 2$ and we can apply Lemma 3.10. From Lemma 3.10 we see that

$$d_W(X_1, Z) \succ d_W(X_0, Z) > K/2$$

and if K is sufficiently large $W \in \mathbf{Y}_\Theta(X_1, Z)$.

Since $d(X_1, Z) \geq 3$ we also have $d(X_1, W) \geq 2$ so there must be elements in $\mathbf{Y}_{K/2}(X_1, Z)$ that are less than W in $\mathbf{Y}_\Theta(X_1, Z)$. We let W' be the greatest such element. By the order property

$$d_W(W', Z) \succ d_W(X_1, Z) \succ K/2$$

and again, if K is sufficient large then $W \in \mathbf{Y}_\Theta(W', Z)$.

We now show that W' is a guard for Z . Note that for any X with $d_{W'}(X, Z) > \Theta$ we also have $d_W(X, Z) > \Theta$ by monotonicity. If $V \in \mathbf{Y}_K(X, Z)$ then $V \leq W$ in $\mathbf{Y}_\Theta(X, Z)$ since W is a guard. If $W' < V$ then $V \in \mathbf{Y}_{K/2}(W', Z) \subseteq \mathbf{Y}_{K/2}(X_1, Z)$ by Lemma 3.9 and monotonicity and therefore $V \neq W$ since $W \notin \mathbf{Y}_{K/2}(X_1, Z)$. However, this contradicts our choice of W' as the greatest element of $\mathbf{Y}_{K/2}(X_1, Z)$ that is less than W . So, $V \leq W'$. \square

3.5 Barriers

Definition 3.13. A *barrier* between a path $\{X_0, \dots, X_k\}$ and a vertex Z is a vertex Y such that $Y \in \mathbf{Y}_\Theta(X_i, Z)$ for all $i = 0, \dots, k$.

By Theorem 3.3 if there is a barrier between $\{X_0, \dots, X_k\}$ and Z then $d_Z(X_i, X_j) < \Theta$ for all i, j .

Proposition 3.14. *If K is sufficiently large the following holds. Assume that $\{X_0, X_1, \dots, X_k\}$ is a path in $\mathcal{P}_K(\mathbf{Y})$ and Z a vertex of $\mathcal{P}_K(\mathbf{Y})$ such that $d(Z, X_i) \geq 3$ for all i . Then there is a barrier W between the path and Z . In particular, $d_Z(X_0, X_i) \sim 0$ for all i .*

Proof. We will inductively choose a family of guards W_i for Z such that $W_i \in \mathbf{Y}_{K/2}(X_i, Z)$ and if $i > j$ then either $W_i = W_j$ or $W_j \in \mathbf{Y}_\Theta(W_i, Z)$.

We choose W_0 to be the greatest element of $\mathbf{Y}_{K/2}(X_0, Z)$, so in particular $\mathbf{Y}_{K/2}(W_0, Z) = \emptyset$ by the order and monotonicity properties. By Lemma 3.9, W_0 is a guard for Z . Now assume that W_0 through W_i have been chosen. If $W_i \in \mathbf{Y}_{K/2}(X_{i+1}, Z)$ then we let $W_{i+1} = W_i$. If not, by Lemma 3.12, there exists a guard W_{i+1} in $\mathbf{Y}_{K/2}(X_{i+1}, Z)$ with $W_i \in \mathbf{Y}_\Theta(W_{i+1}, Z)$. For any $j < i$, by the induction hypothesis, we have that $W_j \in \mathbf{Y}_\Theta(W_i, Z)$ and by monotonicity therefore $W_j \in \mathbf{Y}_\Theta(W_{i+1}, Z)$.

Let $W = W_0$. Again applying monotonicity we have that $\mathbf{Y}_\Theta(X_i, Z) \supseteq \mathbf{Y}_\Theta(W_i, Z)$, therefore $W \in \mathbf{Y}_\Theta(X_i, Z)$, so that W is a barrier between the path and Z and that $d_Z(X_0, X_i) < \Theta$. \square

For geodesic paths we have the following corollary, analogous to Masur-Minsky's Bounded Geodesic Image Theorem.

Corollary 3.15. *If K is sufficiently large the following holds. Assume that $\{X_0, X_1, \dots, X_k, Z\}$ is a geodesic path in $\mathcal{P}_K(\mathbf{Y})$. Then $d_Z(X_0, X_i) \sim 0$ for all i .*

Proof. If $i \leq k - 2$ then this follows directly from Proposition 3.14. By Lemma 3.10, $d_Z(X_{k-2}, X_{k-1}) \sim 0$ and $d_Z(X_{k-1}, X_k) \sim 0$ so the general statement then follows from the coarse triangle inequality. \square

3.6 $\mathcal{P}_K(\mathbf{Y})$ is a quasi-tree

Recall [Man05] that a geodesic metric space \mathcal{X} satisfies the *bottleneck property* if there is a constant $\Delta \geq 0$ such that for any two points $x, z \in \mathcal{X}$ there is a midpoint y (i.e. $d(x, y) = d(y, z) = \frac{1}{2}d(x, z)$) such that any path from x to z intersects the Δ -neighborhood of y . Manning proved in [Man05] that \mathcal{X} is quasi-isometric to a simplicial tree (i.e. it is a *quasi-tree*) if and only if it satisfies the bottleneck property.

There is a slight reformulation of the bottleneck property that is easier to deal with: \mathcal{X} has the bottleneck property if and only if there is a constant Δ' such that for any two points $x, y \in \mathcal{X}$ there is a path p from x to y such that the Δ' -neighborhood of any other path from x to y contains p .

We prove this property implies the original property. Let g be a geodesic from x to y , and m be the mid point. We claim that there is a point m' in p which is in the $(2\Delta' + 1)$ -neighborhood of m . To see this, let $p(i)$ be points on p from x to y with $d(p(i), p(i+1)) \leq 1$. By the property, for each i , there is a point $g(j_i)$ on g with $d(p(i), g(j_i)) \leq \Delta'$. By triangle inequality, $d(g(j_i), g(j_{i+1})) \leq 2\Delta' + 1$. Since g is a geodesic, there must be i such that $d(m, g(j_i)) \leq 2\Delta' + 1$. Set $m' = p(i)$. Then, $d(m, m') \leq 3\Delta' + 1$.

Now for any path q from x to y , there must be a point m'' in q such that $d(m', m'')$ is at most Δ' . So, $d(m, m'')$ is at most $4\Delta' + 1$.

If the space is a graph, we only need to consider vertices rather than all points in the conditions and arguments.

We can now prove:

Theorem 3.16. *For K sufficiently large $\mathcal{P}_K(\mathbf{Y})$ is a quasi-tree. Moreover, the quasi-isometry constant to a tree is uniform.*

Proof. We will verify the modified bottleneck property with $\Delta' = 2$. This also implies a uniform bound on the quasi-isometry constant [Man05, Section 4]. Let X, Z be two vertices of $\mathcal{P}_K(\mathbf{Y})$. The ordered set $\mathbf{Y}_K(X, Z)$ is a path from X to Z (see the proof of Proposition 3.7). We now check that any path $X = X_0, X_1, \dots, X_k = Z$ from X to Z passes within 2 of any vertex Y in $\mathbf{Y}_K(X, Z)$. If not, then by Proposition 3.14 we have $d_Y(X, Z) < \Theta$ contradicting the fact that $Y \in \mathbf{Y}_K(X, Z)$. \square

We could also use the original distance d^π to define a projection complex $\mathcal{P}_K^\pi(\mathbf{Y})$. However it is not a quasi-tree in general. We sketch the construction below.

Example 3.17. (1) For any large integer $K > 0$, $\mathcal{P}_K^\pi(\mathbf{Y})$ can be an arbitrarily large loop and is hence not a quasi-tree with a quasi-isometry constant bounded or even a δ -hyperbolic space with δ bounded.

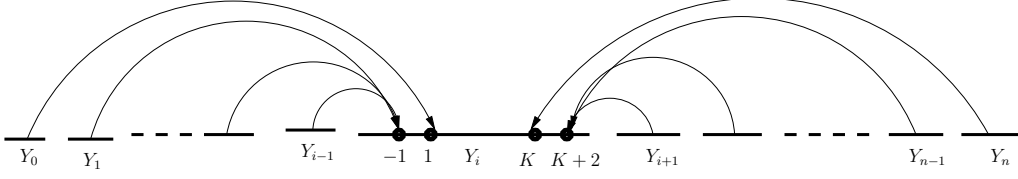

Figure 5: Arrows indicate projections $\pi_{Y_i}(Y_j)$

Suppose $\mathbf{Y} = \{Y_0, \dots, Y_n\}$ is finite and each Y_i is a copy of \mathbb{R} . Fix $K > 10$. For $0 < i < j < n$ we define $\pi_{Y_j}(Y_i) = \{-1\}$ and $\pi_{Y_i}(Y_j) = \{K+2\}$. For $i > 0$ we define $\pi_{Y_i}(Y_0) = \{1\}$ and $\pi_{Y_0}(Y_i) = \{K\}$. For $i < n$ we define $\pi_{Y_i}(Y_n) = \{K\}$ and $\pi_{Y_n}(Y_i) = \{1\}$. See Figure 5. We then define $d_{Y_j}^\pi(Y_i, Y_k)$ in the usual way. It is then straightforward to check that the axioms hold with $\theta = 3$. Furthermore, $d_{Y_j}(Y_i, Y_{i+1}) \leq 2 < K$ for all j and we also have $d_{Y_j}(Y_0, Y_n) = K - 1 < K$ for all j . Therefore, there are edges between Y_i and Y_{i+1} and between Y_0 and Y_n in $\mathcal{P}_K^\pi(\mathbf{Y})$.

On the other hand, if $i < j < k$ and $i \neq 0$ or $k \neq n$ then $d_{Y_j}^\pi(Y_i, Y_k) \geq K + 1$ so there can be no other edges and $\mathcal{P}_K^\pi(\mathbf{Y})$ is a loop of length $n + 1$. We leave it as an exercise to show that $\mathcal{P}_K(\mathbf{Y})$ is a complete graph on $n + 1$ vertices ($(Y_0, Y_n) \in \mathcal{H}(Y_i, Y_j)$ if $0 < i < j < n$, so $d_{Y_k}(Y_i, Y_j) \leq d_{Y_k}^\pi(Y_0, Y_n) = K - 1$ if $0 < i < k < j < n$, hence there is an edge between Y_i, Y_j in $\mathcal{P}_K(\mathbf{Y})$).

(2) Now we want to produce for a given $K > 10$ an example with $\theta = 3$ such that $\mathcal{P}_K^\pi(\mathbf{Y})$ contains arbitrarily large isometrically embedded loops, so it is not a quasi-tree or even a hyperbolic space. For simplicity, we only give an example such that $\mathcal{P}_K^\pi(\mathbf{Y})$ contains a loop of length n and a loop of length m . The idea is to use the examples from (1) for n and m and arrange the projections such that $\mathcal{P}_K^\pi(\mathbf{Y})$ is a bouquet of loops of length n and m .

Suppose $\mathbf{Y} = \{Y_0, \dots, Y_n, \dots, Y_{n+m}\}$ and each Y_i is \mathbb{R} . Define

- For $i < j$ such that $\{i, j\} \cap \{0, n, n + m\} = \emptyset$ let $\pi_{Y_i}(Y_j) = \{K + 2\}, \pi_{Y_j}(Y_i) = \{-1\}$.
- $\pi_{Y_0}(Y_i) = \{K\}$ and $\pi_{Y_i}(Y_0) = \{1\}$ for all $0 < i$.
- $\pi_{Y_n}(Y_i) = \{1\}$ for all $i < n$ and $\pi_{Y_n}(Y_i) = \{K\}$ for all $n < i$.
- $\pi_{Y_i}(Y_n) = \{K\}$ for all $i < n$ and $\pi_{Y_n}(Y_i) = \{1\}$ for all $n < i$.
- $\pi_{Y_{n+m}}(Y_i) = \{1\}$ and $\pi_{Y_i}(Y_{n+m}) = \{K\}$ for all $0 < i$.

Again, the axioms holds for $\theta = 3$. As in (1), the vertices Y_0, \dots, Y_n form a loop of length n and the vertices Y_n, \dots, Y_{n+m} form a loop of length m

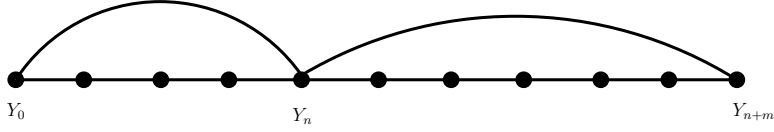

Figure 6: $\mathcal{P}_K^\pi(\mathbf{Y})$ has two loops. $\mathcal{P}_K(\mathbf{Y})$ is a complete graph with the same vertex set. $\mathcal{P}_L(\mathbf{Y})$ and $\mathcal{P}_L^\pi(\mathbf{Y})$ are the lines of length $n+m$ without the two upper edges if $L < K - 1$.

in $\mathcal{P}_K^\pi(\mathbf{Y})$, which consists of the two loops. On the other hand, $\mathcal{P}_K(\mathbf{Y})$ is a complete graph. Note that $\mathcal{P}_L(\mathbf{Y})$ is a line of length $n+m$ if $10 < L < K - 1$. See Figure 6.

Similarly, we can produce an example such that $\mathcal{P}_K^\pi(\mathbf{Y})$ contains an isometrically embedded loop of length n for all $n > 0$, which is not a quasi-tree, while $\mathcal{P}_K(\mathbf{Y})$ is a complete graph. Moreover, $\mathcal{P}_L(\mathbf{Y})$ is an infinite line if $10 < L < K - 1$.

(3) Building on the examples in (2), we can produce an example such that $\mathcal{P}_K^\pi(\mathbf{Y})$ is not a quasi-tree for any K . The idea is that for each large positive integer K we first produce \mathbf{Y}^K and projections as we did in (2) such that $\mathcal{P}_K^\pi(\mathbf{Y}^K)$ contains arbitrarily long loops. Next we put \mathbf{Y}^K together for all K and obtain \mathbf{Y} , then define projections between elements in \mathbf{Y}^K with different K 's as we did for n and m in (2). Then for each large positive integer L , the resulting graph $\mathcal{P}_L^\pi(\mathbf{Y})$ contains the graph $\mathcal{P}_L^\pi(\mathbf{Y}^L)$ as a subgraph, therefore has arbitrarily large embedded loops. On the other hand the quasi-tree $\mathcal{P}_L(\mathbf{Y})$ is unbounded since it contains $\mathcal{P}_L(\mathbf{Y}^K)$ for all K but each of them is a geodesic line for $L < K - 1$. We leave the details to the reader.

Lemma 3.18. *There exists a $K' > 0$ such that if $Y \in \mathbf{Y}_{K'}(X, Z)$ then every geodesic from X to Z in $\mathcal{P}_K(\mathbf{Y})$ contains Y . In particular*

$$d(X, Z) \geq |\mathbf{Y}_{K'}(X, Z)| + 1.$$

Proof. Let $X = X_0, X_1, \dots, X_k = Z$ be a geodesic from X to Z that doesn't contain Y . We will show that $d_Y(X, Z) < 5K$.

If $d(X_i, Y) \geq 3$ for all i then by Proposition 3.14 we have $d_Y(X, Z) \sim 0$. Now assume that $d(X_i, Y) < 3$ for some i . Let i^- be the first time that $d(X_{i^-}, Y) < 3$ and i^+ the last time that $d(X_{i^+}, Y) < 3$. Then $i^+ - i^- \leq 4$ since $d(X_{i^-}, X_{i^+}) \leq 4$. For convenience we will assume $i^- > 0$ and $i^+ < k$; an obvious modification of the argument works when this is not the case. Again applying Proposition 3.14 we have that $d_Y(X, X_{i^-}) \sim 0$ and $d_Y(X_{i^+}, Z) \sim 0$.

Since the path doesn't contain Y then for all X_i we have $d_Y(X_i, X_{i+1}) \leq K$. Using this estimate and the coarse triangle inequality six times we have

$$d_Y(X_{i-1}, X_{i+1}) \prec 5K.$$

Combining with our bounds on $d_Y(X, X_{i-1})$ and $d_Y(X, X_{i+1})$ and applying the coarse triangle inequality two more times we have $d_Y(X, Z) \prec 5K$. Therefore there exists a K' with $K' \sim 5K$ such that if $Y \in \mathbf{Y}_{K'}(X, Z)$ then every geodesic from X to Z contains Y . This implies the lemma. \square

The next corollary is in preparation for studying axes of isometries on the projection complex.

Let α be a biinfinite geodesic in $\mathcal{P}_K(\mathbf{Y})$ and define for a constant $L > 0$

$$\mathbf{Y}_L(\alpha) = \{Y \in \mathbf{Y} \mid \exists X, Z \in \alpha \text{ such that } d_Y(X, Z) > L\}$$

and the *stable part* of α by

$$\mathbf{Y}(\alpha) = \{Y \in \mathbf{Y} \mid \text{if a biinfinite geodesic } \beta \text{ is parallel to } \alpha \text{ then } Y \in \beta\} \subset \alpha.$$

In other words, $\mathbf{Y}(\alpha)$ is the intersection of all biinfinite geodesics parallel to α (including α). Clearly, if α is parallel to β then $\mathbf{Y}(\alpha) = \mathbf{Y}(\beta)$.

Corollary 3.19. *Let K' be the constant from Lemma 3.18.*

(i) $\mathbf{Y}_{K'}(\alpha) \subset \alpha$.

(ii) *There exists a $K'' \geq K' > 0$ such that the following holds. Let $D > 0$ be a constant, and X_0, X_1 vertices in $\mathcal{P}_K(\mathbf{Y})$ and Y_0, Y_1 vertices in α such that $d(X_i, Y_i) < D$. If $Z \in \mathbf{Y}_{K''}(\alpha)$ lies between Y_0 and Y_1 on α and $d(X_i, Z) > 2D + 2$ then $Z \in \beta$ for any geodesic β between X_0 and X_1 .*

(iii) $\mathbf{Y}_{K''}(\beta) \subset \mathbf{Y}(\alpha)$ for any geodesic β that is parallel to α .

Proof. (i) follows directly from Lemma 3.18.

For (ii) we note that there is a (geodesic) path from Y_i to X_i such that every vertex in the path has distance at least 3 from Z so by Proposition 3.14, $d_Z(X_i, Y_i) \sim 0$. Since $Z \in \mathbf{Y}_{K''}(\alpha)$ there exists $Y'_0, Y'_1 \in \alpha$ with $d_Z(Y'_0, Y'_1) > K''$. Since Z lies between Y_0 and Y_1 we can assume that Y_0 and Y'_0 are on the same side of Z (and similarly for Y_1 and Y'_1). Therefore there is a geodesic path from Y_i to Y'_i that is disjoint from Z and so by Corollary 3.15, $d_Z(Y_i, Y'_i) \sim 0$. Applying the coarse triangle inequality we have that

$d_Z(X_i, Y_i') \sim 0$ and $d_Z(X_0, X_1) \succ K''$. Therefore if K'' is sufficiently large $d_Z(X_0, X_1) > K'$ and by Lemma 3.18 we have that Z lies in every geodesic between X_0 and X_1 .

Assume that $Z \in \mathbf{Y}_{K''}(\beta)$ and let γ be parallel to α (and hence β). The geodesic γ is contained in the D -Hausdorff neighborhood of β for some $D > 0$. Therefore we can find vertices $X_0, X_1 \in \gamma$ and vertices $Y_0, Y_1 \in \beta$ such that $d(X_i, Y_i) \leq D$, $d(X_i, Z) > 2D + 2$ and Z lies between Y_0 and Y_1 . Then by (ii), $Z \in \gamma$ and (iii) follows. \square

Finally, we establish that the projection complex has infinite diameter under mild conditions.

Proposition 3.20 ($\mathcal{P}_K(\mathbf{Y})$ is unbounded). *Suppose that for every $R > 0$ and $A \in \mathbf{Y}$ there exist $B, C \in \mathbf{Y}$ such that $d_A^\pi(B, C) > R$. Then the diameter of $\mathcal{P}_K(\mathbf{Y})$ is infinite.*

Proof. Let K' be the constant from Lemma 3.18. Choose $A_0, A_1, A_2 \in \mathbf{Y}$ such that $d_{A_1}(A_0, A_2) > K'$. Applying the assumption to A_2 , find B, C so that $d_{A_2}(B, C) \succ 3K'$. It follows from the coarse triangle inequality that for either $A_3 = B$ or $A_3 = C$ we have $d_{A_2}(A_1, A_3) > K'$. Continuing in the same fashion (by induction), we can extend the sequence A_i forever with $d_{A_i}(A_{i-1}, A_{i+1}) > K'$. By Lemma 3.5, for each $0 < j < i$ we have $d_{A_j}(A_0, A_i) > K'$. Thus by Lemma 3.18 $d_{\mathcal{P}_K(\mathbf{Y})}(A_0, A_i) \geq i$. \square

3.7 Group action on the projection complex

Now assume that G is a group that acts on the set \mathbf{Y} in such a way that projection distances are G -equivariant, i.e. $d_{g(A)}^\pi(g(B), g(C)) = d_A^\pi(B, C)$ for all $A, B, C \in \mathbf{Y}$ and $g \in G$. Then G acts naturally on the projection complex $\mathcal{P}_K(\mathbf{Y})$ by automorphisms.

The following proposition is clear since $\mathcal{P}_K(\mathbf{Y})$ is connected.

Proposition 3.21. *Suppose the action of G on \mathbf{Y} has finitely many orbits. Then the action of G on $\mathcal{P}_K(\mathbf{Y})$ is cobounded (i.e. a Hausdorff neighborhood of an orbit is the whole space).*

Next, we construct axes of (powers of) elements with unbounded orbits. Note that axes are geodesics by definition.

Let K' be the constant from Lemma 3.18 and K'' the constant from Corollary 3.19.

Lemma 3.22 (Axial isometry). *Suppose $g \in G$ and $Y \in \mathbf{Y}$ such that*

$$d_Y(g^{-N}(Y), g^N(Y)) > K'$$

for some $N > 0$. Then g^N has an axis α that contains $g^{kN}(Y)$ for all $k \in \mathbb{Z}$. In particular, g acts on $\mathcal{P}_K(\mathbf{Y})$ with positive translation length. Furthermore if

$$d_Y(g^{-N}(Y), g^N(Y)) > K''$$

then g has an axis that contains all g -translates of Y .

Proof. By the G -equivariance of the projection distance, Lemma 3.5 applies to $\{Y, g^N(Y), \dots, g^{kN}(Y)\}$, so that $d_{g^{iN}(Y)}(Y, g^{kN}(Y)) > K'$ for $0 < i < k$. Now, Lemma 3.18 gives

$$d(Y, g^{kN}(Y)) = kd(Y, g^N(Y))$$

which implies that the translation length

$$\tau(g) = \lim_{k \rightarrow \infty} \frac{d(Y, g^{kN}(Y))}{kN} = \frac{kd(Y, g^N(Y))}{kN} \geq \frac{1}{N} > 0.$$

To construct α take a geodesic segment between Y and $g^N(Y)$ and translate it by the action of g^N to get a bi-infinite path.

Now assume $d_Y(g^{-N}(Y), g^N(Y)) > K''$. For all $k \in \mathbb{Z}$, $g^k(\alpha)$ will be parallel to α and $g^k(Y) \in \mathbf{Y}_{K''}(g^k(\alpha))$. By (iii) of Corollary 3.19, $g^k(Y) \in \mathbf{Y}(\alpha)$. In particular, $g^k(Y) \in \alpha$. By replacing the geodesic segment in α from $g^k(\alpha)$ to $g^{k+1}(\alpha)$ with the g^k -translate of the geodesic segment in α from Y to $g(Y)$ we obtain a g -invariant geodesic. \square

Using the same idea but a bit more work we can find a copy of F_2 in G that acts on an embedded tree in $\mathcal{P}_K(\mathbf{Y})$ such that any non-trivial element in F_2 has an axis in the tree.

Proposition 3.23 (Free subgroup of axial elements). *Fix $Z_1, Z_2 \in \mathbf{Y}$ and $g_1, g_2 \in G$ and then define $Z_j^k = g_j^k(Z_j)$ with $k = \pm 1$. Assume that for a constant L and all permutations of $i, j \in \{1, 2\}$ with $i \neq j$ and $k \in \{-1, 1\}$ we have*

- $d_{Z_j}(Z_j^{-1}, Z_j^1) > L \geq K'$;
- $d_{Z_j}(Z_j^k, Z_i) > L \geq K'$.

Then:

1. $F = \langle g_1, g_2 \rangle$ is a non-abelian free group.
2. There exists a trivalent F -invariant tree S isometrically embedded in $\mathcal{P}_K(\mathbf{Y})$ and the F -action is proper and minimal.
3. For every non-trivial $\phi \in F$ there is vertex $W \in S$ such that

$$d_W(\phi^{-1}(W), \phi(W)) > L.$$

Further, ϕ has an axis contained in S .

Proof. Let $\tilde{F} = \langle a, b \rangle$ be the free group of words in a and b . Then \tilde{F} is the fundamental group of the barbell group and therefore acts on its universal cover, a trivalent tree \tilde{S} . We can assume that the axes α and β of a and b in \tilde{S} are disjoint but connected by a single edge whose endpoints are vertices $\tilde{Z}_1 \in \alpha$ and $\tilde{Z}_2 \in \beta$. If each edge of \tilde{S} has length one we can also assume that the translations of a and b are both one. Define a homomorphism from \tilde{F} to $F = \langle g_1, g_2 \rangle \subset G$ by $a \mapsto g_1$ and $b \mapsto g_2$. We then choose a map $\psi : \tilde{S} \rightarrow \mathcal{P}_K(\mathbf{Y})$ that is equivariant with respect to this homomorphism and with $\psi(\tilde{Z}_i) = Z_i$. By scaling the length of the edges of \tilde{S} we can make this map an isometry on each edge. We will show that it is in fact a global isometry and the conclusions of the proposition will follow.

Note that there are exactly two \tilde{F} -orbits of vertices in \tilde{S} with one containing \tilde{Z}_1 and the other containing \tilde{Z}_2 . Therefore if \tilde{Y}_0, \tilde{Y}_1 and \tilde{Y}_2 are consecutive vertices in \tilde{S} then there exists a (unique) $w \in \tilde{F}$ such that $w(\tilde{Y}_1) = \tilde{Z}_1$ or $w(\tilde{Y}_1) = \tilde{Z}_2$. Assume it is the former. Then $w(\tilde{Y}_0)$ and $w(\tilde{Y}_2)$ will be distinct elements in the set $\{a(\tilde{Z}_1), a^{-1}(\tilde{Z}_1), \tilde{Z}_2\}$. The ψ -image of this set is $\{Z_1^1, Z_1^{-1}, Z_2\}$ so for all possibilities we have that

$$d_{Y_1}(Y_0, Y_2) = d_{\psi(w(\tilde{Y}_1))}(\psi(w(\tilde{Y}_0)), \psi(w(\tilde{Y}_2))) > L$$

where $Y_i = \psi(\tilde{Y}_i)$ by our assumption. The latter case is similar.

By Lemma 3.5 it follows that for a chain of consecutive vertices $\tilde{Y}_0, \dots, \tilde{Y}_n$ in \tilde{S} we have $d_{Y_j}(Y_0, Y_n) > L$ for all $j = 1, \dots, n-1$ again with $Y_i = \psi(\tilde{Y}_i)$. By Lemma 3.18, Y_j is contained in every geodesic from Y_0 to Y_n and it follows that ψ is a global isometry. This implies (1) and (2).

For (3) we note that every $\phi \in F$ is the image of some $\tilde{\phi}$ in \tilde{F} . The ψ -image of the axis of $\tilde{\phi}$ in \tilde{S} will be an axis for ϕ . If \tilde{W} is contained in this axis then it is contained in a consecutive chain of vertices from $\tilde{\phi}^{-1}(\tilde{W})$ to $\tilde{\phi}(\tilde{W})$ and therefore, by the previous argument, $d_W(\phi^{-1}(W), \phi(W)) > L$ where $W = \psi(\tilde{W})$. \square

Example 3.24 (Cayley tree). In Section 2.5 we discussed the Cayley tree of a free group. In that example, we can take the axis of a as Y , $g = a^n b$ in Lemma 3.22 where $n \gg K$; and in Proposition 3.23 take $g_1 = a^{2n} b$ with Z_1 the axis of a and again $n \gg K$. We then conjugate g_1 with $a^n b a^{-n}$ to get g_2 and let $Z_2 = a^n b a^{-n}(Z_1)$. (For a more general strategy for choosing g_1 and g_2 see the proof of Corollary 3.25). As we will see any non-trivial element in F is WPD by Proposition 3.27 since the common stabilizer of a pair of distinct points in \mathbf{Y} is trivial (see Remark 3.28).

We state a corollary (of Theorem 3.16 and Proposition 3.23). We have to verify the axioms (P0), (P1) and (P2) and in this general setting it will be done in [BBFb] (i.e., when we prove Theorem H). In particular, it will apply to all groups that are listed in Example 2.1. In this paper we have verified the axioms for discrete subgroups of isometries of \mathbb{H}^n and it is straightforward to generalize this to hyperbolic groups. Even in these cases the result is new.

Recall that an action on a quasi-tree is *non-elementary* if the orbits are unbounded, and there is no fixed end, nor a pair of ends.

Corollary 3.25. *Let G be a group which acts on a geodesic metric space X with a WPD element with respect to the action that has a B -contracting orbit.*

If G is not virtually cyclic then it has a non-elementary cobounded action on a quasi-tree.

Proof. Let $a \in G$ be a (hyperbolic) element that is WPD with an axis α (if there is no geodesic axis, take an invariant quasi-geodesic, or the orbit of an point). Let \mathbf{Y} be the collection of parallel classes of G -translates of α . As we said, under the assumption, the axioms (P0)-(P2) are satisfied, [BBFb]. We apply our construction to \mathbf{Y} and obtain a G -quasi-tree $\mathcal{P}_K(\mathbf{Y})$ by Theorem 3.16.

To see that the action is non-elementary we need to find $g_1, g_2 \in G$ for which we can apply Proposition 3.23. Let $Y \in \mathbf{Y}$ be the equivalence class of α . \mathbf{Y} contains an element $Z \neq Y$ (since otherwise, every G -translate of α is parallel to α , but then G is virtually cyclic by WPD) such that $h(Y) = Z$ for some $h \in G$. Set $Z_1 = Y$ and $Z_2 = Z$. For an n to be determined shortly we also set $Z_1^{\pm 1} = a^{\pm n} h^{\mp 1}(Z_1)$ and $Z_2^{\pm 1} = h(Z_1^{\pm 1})$. Note that for any $X_0, X_1 \neq Y$ both $d_Y(X_0, a^{\pm n}(X_1))$ and $d_Y(a^{-n}(X_0), a^n(X_1))$ grow linearly in n and it follows that given $L > 0$, for n sufficiently large Z_1, Z_2 and $Z_1^{\pm 1}, Z_2^{\pm 1}$ satisfy the assumption of Proposition 3.23. For example $d_{Z_1}(Z_2, Z_1^1) = d_{Z_1}(Z_2, a^n(h^{-1}Z_1))$ is $> L$ for large n . We next set $g_1 =$

$a^n h^{-1} a^n$ and $g_2 = h g_1 h^{-1}$ and check that $g_i^j(Z_i) = Z_i^j$ for $i = 1, 2$ and $j = \pm 1$ so that g_1 and g_2 also satisfy the assumption of Proposition 3.23. By (1) and (2) of Proposition 3.23 we then have that $\langle g_1, g_2 \rangle$ is free and acts isometrically on a isometrically embedded tree in $\mathcal{P}_K(\mathbf{Y})$ so the action of G is non-elementary. \square

In the rest of this section we study the WPD property (as defined in Section 2.2) of the action on the projection complex. We start by constructing a total order on the combinatorial axis of an element.

If $g \in G$ is hyperbolic and has an axis α define the *combinatorial axis* as $\mathbf{Y}(g) = \mathbf{Y}(\alpha)$. This does not depend on the choice of α . $\mathbf{Y}(g)$ is possibly empty. We recall the *elementary closure*, $EC(g)$, of g is the subgroup of elements $h \in G$ such that $h(\alpha)$ is parallel to α .

Proposition 3.26 (Combinatorial axis and elementary closure). *Assume $\mathbf{Y}(g)$ is not empty. Then there is a total order on $\mathbf{Y}(g)$ such that*

- (i) $\mathbf{Y}(g)$ is $EC(g)$ -invariant and the $EC(g)$ -action preserves the order up to sign.
- (ii) The order is unique if we require $g(Y) > Y$ for some (every) $Y \in \mathbf{Y}(g)$.
- (iii) $\mathbf{Y}(g)$ is order-isomorphic to \mathbb{Z} and $EC(g)$ acts as isometries of \mathbb{Z} under this isomorphism.
- (iv) Assume that $Y_0, Y_1, Y_2, Y'_0, Y'_2 \in \mathbf{Y}(g)$ with Y_1 between both the pair Y_0 and Y_2 and the pair Y'_0 and Y'_2 . Then $d_{Y_1}(Y_0, Y_2) \sim d_{Y_1}(Y'_0, Y'_2)$.

Proof. Let α be an oriented axis for g so that g is a positive translation with respect to the orientation. The vertices of α have an order which induces a total order on $\mathbf{Y}(\alpha)$.

Let β be parallel to α and $h \in EC(g)$. If $h(Y) \notin \beta$ then $Y \notin h^{-1}(\beta)$. Since $h^{-1}(\beta)$ will also be parallel to α we have that if $Y \in \mathbf{Y}(g)$ then $g(Y) \in \mathbf{Y}(g)$, proving (i).

For (ii) we note that by our choice of orientation for $Y \in \alpha$, $g(Y)$ appears after Y .

The vertices in $\mathbf{Y}(g)$ are a discrete set in α so the order coming from α will be order isomorphic to \mathbb{Z} and we can accordingly label them Y_n . In particular if $k < n < m$ then Y_n is between Y_k and Y_m on α . If $h \in EC(g)$ then the same must be true on $h(\alpha)$ for otherwise we could build a geodesic parallel to α that did not contain Y_n by replacing the geodesic segment from Y_k to Y_m on α with the segment with the same endpoints on

$h(\alpha)$. If h_* is the induced map on \mathbb{Z} then this implies that $|h_*(n) - h_*(m)| = |n - m|$ proving (iii).

For (iv) we can assume that both Y_0 and Y'_0 are less than Y_1 in the total order. Then $d_{Y_1}(Y_0, Y'_0) \sim 0$ by Corollary 3.15 and similarly $d_{Y_1}(Y_2, Y'_2) \sim 0$. The coarse triangle inequality then implies (v). \square

The following provides a sufficient condition for an element to be hyperbolic and WPD.

Proposition 3.27 (Axial and WPD). *Assume that $g \in G$ satisfies*

(i) *there exists a vertex Y and an $N > 0$ such that $d_Y(g^{-N}(Y), g^N(Y)) > K''$;*

(ii) *there exists an $m > 0$ such that the subgroup of G that fixes*

$$Y, g(Y), \dots, g^m(Y)$$

is finite.

Then g has an axis and the action of g on $\mathcal{P}_K(\mathbf{Y})$ is WPD.

Proof. By Lemma 3.22 g is hyperbolic and has an axis. Fix a $D > 0$ which for simplicity we'll assume is an integer and let $M = 7D + 7 + m$. We need two claims:

(a) If $d(Y, \phi(Y)) \leq D$ and $d(g^M(Y), \phi(g^M(Y))) \leq D$ then the commutator $[\phi, g]$ lies in a finite set of elements.

(b) There are only finitely many $\psi \in G$ with

$$d(Y, \psi(Y)) \leq D \text{ and } d(g^M(Y), \psi(g^M(Y))) \leq D$$

and with $[\phi, g] = [\psi, g]$.

These two claims imply that the set

$$\{\phi \in G \mid d(Y, \phi(Y)) \leq D \text{ and } d(g^M(Y), \phi(g^M(Y))) \leq D\}$$

is finite and g is WPD.

We now prove (a). By (ii) of Corollary 3.19, $g^{3D+3}(Y), \dots, g^{4D+4+m}(Y)$ will be in every geodesic from $\phi(Y)$ to $\phi(g^M(Y))$. We also note that

$$\mathbf{Y}(\phi g \phi^{-1}) = \phi(\mathbf{Y}(g))$$

so $\phi(Y), \phi(g^M(Y)) \in \mathbf{Y}(\phi g \phi^{-1})$ and therefore $g^i(Y) \in \mathbf{Y}(\phi g \phi^{-1})$ for $i = 3D + 3, \dots, 4D + 4 + m$. Furthermore the order (up to sign) that the $g^i(Y)$ appear in $\mathbf{Y}(g)$ must be the same as their order in $\mathbf{Y}(\phi g \phi^{-1})$ and in particular $\phi g \phi^{-1}(g^i(Y)) = g^{i \pm 1}(Y)$ for $i = 3D + 4, \dots, 4D + 3 + m$ since g and $\phi g \phi^{-1}$ have the same translation length. We first need to show that $\phi g \phi^{-1}(g^i(Y)) = g^{i+1}(Y)$ instead of $g^{i-1}(Y)$.

Assume not and that $\phi g \phi^{-1}(g^i(Y)) = g^{i-1}(Y)$. Then ϕ reverses the order of the $g^i(Y)$ in $\mathbf{Y}(\phi g \phi^{-1})$ and in particular, $g^{4D+3+m}(Y)$ occurs before $g^{3D+4}(Y)$. Since $d(\phi(Y), \phi(g^M(Y))) = M\tau(g)$ and $d(g^{4D+4+m}(Y), g^{3D+3}(Y)) = (D+m+1)\tau(g)$ one of $d(\phi(Y), g^{4D+3+m}(Y))$ or $d(g^{3D+4}(Y), \phi(g^M(Y)))$ must be no greater than $(M - (D + m + 1))\tau(g)/2 = (3D + 3)\tau(g)$. Assume it is the former. The proof is similar in the latter case. Since $\tau(g) \geq 1$ and $d(Y, \phi(Y)) \leq D$ the triangle inequality implies that $d(Y, g^{4D+4+m}(Y)) \leq D + (3D + 3)\tau(g) \leq (4D + 3)\tau(g)$. On the other hand $d(Y, g^{4D+4+m}(Y)) = (4D + 4 + m)\tau(g) > (4D + 3)\tau(g)$, contradiction.

Therefore $\phi g \phi^{-1}(g^i(Y)) = g^{i+1}(Y)$ and $[\phi, g](g^{i+1}(Y)) = \phi g \phi^{-1}(g^i(Y)) = g^{i+1}(Y)$ for $i = 3D + 4, \dots, 4D + 2 + m$. Now notice that the subgroup that fixes $Y, g(Y), \dots, g^m(Y)$ will be isomorphic to the subgroup that fixes $g^{3D+3}(Y), \dots, g^{3D+3+m}(Y)$. Hence the finiteness of the former implies the finiteness of the later. Therefore there are finitely many possibilities for $[\phi, g]$.

For claim (b) we note that if $[\phi, g] = [\psi, g]$ then $\psi^{-1}\phi$ conjugates g to itself and therefore $\psi^{-1}\phi \in EC(g)$. By Proposition 3.26, $\mathbf{Y}(g)$ is order isomorphic to \mathbb{Z} and the induced map $(\psi^{-1}\phi)_*$ on \mathbb{Z} is an isometry. If $(\psi^{-1}\phi)_*$ was a reflection then it would conjugate g to g^{-1} so we must have that $(\psi^{-1}\phi)_*$ is a translation. Since the translation distance of $(\psi^{-1}\phi)_*$ on \mathbb{Z} will be at most the translation distance of $\psi^{-1}\phi$ on $\mathcal{P}_K(\mathbf{Y})$ and ϕ and ψ translate Y at most D we have that the translation length $(\psi^{-1}\phi)_*$ is at most $2D$. There is a bijection from the subgroup that fixes $\mathbf{Y}(g)$ pointwisely to the set of elements that translate $\mathbf{Y}(g)$ any fixed length. Since the former is finite by (ii) so is the later. This implies that there are finitely many possible elements that translate $\mathbf{Y}(g)$ with translation length $\leq 2D$ and hence finitely many possibilities for $\psi^{-1}\phi$ and ψ proving (b) and the proposition. \square

Remark 3.28. In Corollary 3.25 we produced a non-elementary cobounded action on a quasi-tree if G is non elementary by finding a free subgroup $F < G$ using Proposition 3.23. Furthermore, each non-trivial element in F will be WPD on the quasi-tree if the stabilizer of two vertices in $\mathcal{P}_K(\mathbf{Y})$ is finite (for example, in many examples in Example 2.1), where \mathbf{Y} is the set of

translates of an axis. This is because we only need to verify (i) of Proposition 3.27 since (ii) is a trivial consequence of (i) under the extra assumption. But when we apply Proposition 3.23 in the proof of Corollary 3.25, putting $L = K''$, for all non-trivial elements $\phi \in F$ we have $d_W(\phi^{-1}(W), \phi(W)) > L$, which verifies the condition (i) for $N = 1$, therefore ϕ is WPD.

4 A quasi-tree of metric spaces

4.1 Axioms and construction

In all examples in Example 2.1 the set \mathbf{Y} and the functions d_Y^π all arose from geometric settings. We now formalize this. For each $Y \in \mathbf{Y}$ let $\mathcal{C}(Y)$ be a geodesic metric space. In the introduction our notation was such that Y itself was a metric space and $\mathcal{C}(Y) = Y$. But now we will make a distinction, motivated by the example where elements $Y \in \mathbf{Y}$ represent incompressible subsurfaces of a surface Σ and $\mathcal{C}(Y)$ is the curve complex of Y . Let π_Y be a function, called *projection*, from $\mathbf{Y} \setminus \{Y\}$ to subsets of $\mathcal{C}(Y)$. We then define π_Y on $x \in \mathcal{C}(X)$ for $X \neq Y$ by $\pi_Y(x) = \pi_Y(X)$. On $\mathcal{C}(Y)$ itself we define π_Y to be the identity map. (Strictly speaking π_Y takes points in $\mathcal{C}(Y)$ to singleton subsets of $\mathcal{C}(Y)$.) We now assume there is a constant $\theta \geq 0$ such that

(P0) for all $X \neq Y$, $\text{diam}(\pi_Y(X)) \leq \theta$;

We then define

$$d_Y^\pi(X, Z) = \text{diam}\{\pi_Y(X) \cup \pi_Y(Z)\}.$$

We assume that axioms (P1) and (P2) hold for θ (see the introduction). Then, as we said, the projection complex axioms (PC 1) – (PC 4) in Section 3 immediately follow for d_Y^π and θ .

Note that the examples 2.1 that were discussed at the start of the paper all arise in this way. We also define $d_Y^\pi(x, z) = \text{diam}\{\pi_Y(x) \cup \pi_Y(z)\}$, and similarly for $d_Y^\pi(x, Z)$. Note that $d_Y^\pi(x, z)$ still makes sense if $x \in \mathcal{C}(Y)$ and/or $z \in \mathcal{C}(Y)$ as does $d_Y^\pi(x, Z)$ if $x \in \mathcal{C}(Y)$.

We define $d_Y(x, Z)$ exactly as before. Moreover, (1) if neither $x \in \mathcal{C}(Y)$ nor $z \in \mathcal{C}(Y)$ then we set $d_Y(x, z) = d_Y(X, Z)$; (2) if either $x \in \mathcal{C}(Y)$ or $z \in \mathcal{C}(Y)$ then $d_Y(x, z) = d_Y^\pi(x, z)$; (3) if $Y \neq Z$, then $d_Y(x, Z) = d_Y^\pi(x, Z)$. In these last two cases we don't have the monotonicity lemma and in fact the lemma doesn't even make sense. Finally we define $\mathbf{Y}_K(x, z)$ to be the set of Y such that $d_Y(x, z) > K$. These sets are almost the same as $\mathbf{Y}_K(X, Z)$ although they may possibly contain X or Z . We similarly define $\mathbf{Y}_K(x, Z)$.

The following definition depends not only on the choice of K but also on the choice of a constant L .

Definition 4.1. A *quasi-tree of metric spaces* is the path metric space $\mathcal{C}(\mathbf{Y}) = \mathcal{C}_K(\mathbf{Y})$ obtained by taking the disjoint union of the metric spaces $\mathcal{C}(Y)$ for $Y \in \mathbf{Y}$ and if $d(X, Z) = 1$ in $\mathcal{P}_K(\mathbf{Y})$ we attach an edge of length L from every point in $\pi_X(Z)$ to every point in $\pi_Z(X)$.

For any two choices of L the corresponding complexes will be quasi-isometric; however, we will fix L as a function of K in Lemma 4.2 below, and we regard the construction of $\mathcal{C}(\mathbf{Y})$ as depending on K only. In this way, we can assure that the metric spaces $\mathcal{C}(Y)$ will be totally geodesically embedded in $\mathcal{C}(\mathbf{Y})$ but that L will still be comparable to K . This will streamline some of our proofs. Note that $|L - K|$ is bounded above by a constant depending only on θ , and that in particular, $L(K) < 2K$ and $K < 2L(K)$ if K is sufficiently large (we could assume $K \leq L$ then $K < 2L$ is trivial).

Lemma 4.2. *There exists an $L = L(K)$ with $L \sim K$ such that*

$$d_{\mathcal{C}(\mathbf{Y})}(x, z) \geq d_Y^\pi(x, z)$$

for all $Y \in \mathcal{C}(\mathbf{Y})$ with equality if and only if both x and z are in Y . In particular each $\mathcal{C}(Y)$ is totally geodesically embedded in $\mathcal{C}(\mathbf{Y})$.

Note that in this lemma we use the unmodified projection functions, d_Y^π as we will need to apply the triangle inequality an indeterminate number of times. To simplify notation we will restrict the discussion to the case when each $\mathcal{C}(Y)$ is a connected graph endowed with length metric with each edge of length 1 and the projections $\pi_Y(X) \subset \mathcal{C}(Y)$ are sets of vertices. The general case is an easy modification, or indeed, one may replace $\mathcal{C}(Y)$ by the Vietoris-Rips complex whose vertices are the points of $\mathcal{C}(Y)$, and edges correspond to pairs of points at distance ≤ 1 . Also in Lemma 4.5 and 4.6 we view all points as vertices.

Proof. Let $\mathcal{C}'(\mathbf{Y})$ be the space obtained by collapsing $\mathcal{C}(Z)$ for every $Z \in \mathbf{Y} \setminus \{Y\}$. Let x_0, x_1, \dots, x_k be a shortest path of adjacent vertices between the images of x and z in $\mathcal{C}'(\mathbf{Y})$. Thus each x_i is either a vertex in $\mathcal{C}(Y)$ or it is some $Z \in \mathbf{Y} \setminus \{Y\}$.

We'll show that $d_Y^\pi(x_i, x_{i+1}) \leq d_{\mathcal{C}'(\mathbf{Y})}(x_i, x_{i+1})$ with equality if and only if both x_i and x_{i+1} are in $\mathcal{C}(Y)$. There are three cases. If neither x_i or x_{i+1} are in $\mathcal{C}(Y)$ then by the coarse equality

$$d_Y^\pi(x_i, x_{i+1}) \prec d_Y(x_i, x_{i+1}) < K$$

and

$$d_{\mathcal{C}'(\mathbf{Y})}(x_i, x_{i+1}) = L.$$

Since $d_Y^\pi(x_i, x_{i+1})$ is bounded above by K plus a constant depending only on θ ,

$$d_Y^\pi(x_i, x_{i+1}) < d_{\mathcal{C}'(\mathbf{Y})}(x_i, x_{i+1})$$

if L is sufficiently large, but also we may assume $L \sim K$. If x_i and x_{i+1} are both in $\mathcal{C}(Y)$ then $d_{\mathcal{C}'(\mathbf{Y})}(x_i, x_{i+1}) = d_Y^\pi(x_i, x_{i+1}) = 1$. If exactly one of the two is in $\mathcal{C}(Y)$ we have $d_Y^\pi(x_i, x_{i+1}) \sim 0$ and $d_{\mathcal{C}'(\mathbf{Y})}(x_i, x_{i+1}) = L$ so $d_Y^\pi(x_i, x_{i+1}) < d_{\mathcal{C}'(\mathbf{Y})}(x_i, x_{i+1})$ for sufficiently large L . Again L can be chosen such that $L \sim K$.

The triangle inequality then shows that

$$d_{\mathcal{C}'(\mathbf{Y})}(x_0, x_k) \geq d_Y^\pi(x_0, x_k) = d_Y^\pi(x, z)$$

with equality if and only if all of the x_i are in $\mathcal{C}(Y)$. Since the projection to $\mathcal{C}'(\mathbf{Y})$ is 1-Lipschitz we have

$$d_{\mathcal{C}(\mathbf{Y})}(x, z) \geq d_Y^\pi(x, z)$$

with equality if and only if x and z are in $\mathcal{C}(Y)$.

To see that $\mathcal{C}(Y)$ is totally geodesically embedded in $\mathcal{C}(\mathbf{Y})$ we observe that d_Y^π is the metric on $\mathcal{C}(Y)$ and we have just shown that if x and z are in $\mathcal{C}(Y)$, any path in $\mathcal{C}(\mathbf{Y})$ that leaves $\mathcal{C}(Y)$ has length strictly longer than $d_Y^\pi(x, z)$. Therefore every geodesic from x to z is contained in $\mathcal{C}(Y)$. \square

4.2 Distance estimate in $\mathcal{C}(\mathbf{Y})$

The main result of this section is Theorem 4.13, which is a distance estimate in the style of Masur-Minsky. We start by writing down a straightforward estimate for an upper bound for the distance in $\mathcal{C}(\mathbf{Y})$. This is obtained by constructing a “standard path” joining two points and computing its length.

Definition 4.3. A *standard path* from $x \in \mathcal{C}(X)$ to $z \in \mathcal{C}(Z)$ is any path that passes through $\mathcal{C}(W)$ if and only if $W \in \mathbf{Y}_K(X, Z) \cup \{X, Z\}$, it passes through them in the natural order, and within each $\mathcal{C}(W)$ the path is a geodesic.

Lemma 4.4. *For K sufficiently large*

$$d_{\mathcal{C}(\mathbf{Y})}(x, z) \leq 6K + 4 \sum_{Y \in \mathbf{Y}_K(x, z)} d_Y(x, z)$$

for all $x, z \in \mathcal{C}(\mathbf{Y})$, and moreover the length of any standard path from x to z is bounded above by the same expression.

Proof. Let X and Z be the vertices in \mathbf{Y} with $x \in \mathcal{C}(X)$ and $z \in \mathcal{C}(Z)$. Let $\mathbf{Y}_K(X, Z) \cup \{X, Z\} = \{X = Y_0, Y_1, \dots, Y_k = Z\}$ with labeling respecting the order (cf. Proposition 3.7 and its proof). Let x_i^+ be a point in $\pi_{Y_i}(Y_{i+1})$ and x_i^- a point in $\pi_{Y_i}(Y_{i-1})$, where defined. At the endpoints let $x_0^- = x$ and $x_k^+ = z$. Since the distance between x_i^+ and x_{i+1}^- is L we have

$$d_{\mathcal{C}(\mathbf{Y})}(x, z) \leq kL + \sum d_{\mathcal{C}(Y)}(x_i^-, x_{i+1}^+).$$

Now we estimate $d_{\mathcal{C}(\mathbf{Y})}(x_i^-, x_{i+1}^+)$. For $i \in \{1, \dots, k-1\}$ we have

$$\begin{aligned} d_{\mathcal{C}(\mathbf{Y})}(x_i^-, x_{i+1}^+) &\leq d_{Y_i}^{\pi}(Y_{i-1}, Y_{i+1}) \\ &< d_{Y_i}(Y_{i-1}, Y_{i+1}) \\ &< d_{Y_i}(x, z) \end{aligned}$$

where the second line follows from the coarse equality property and the third follows from the order property. Since $d_{Y_i}(x, z) > K$ this implies that

$$d_{\mathcal{C}(\mathbf{Y})}(x_i^-, x_{i+1}^+) < 2d_{Y_i}(x, z)$$

for K sufficiently large.

Since $L = L(K) \sim K$ we also have that $L < 2K$ if K is sufficiently large and since $d_{Y_i}(x, z) > K$ we have $L < 2d_{Y_i}(x, z)$ and

$$L + d_{\mathcal{C}(\mathbf{Y})}(x_i^-, x_{i+1}^+) \leq 4d_{Y_i}(x, z).$$

We similarly have that $d_{\mathcal{C}(\mathbf{Y})}(x_i^-, x_{i+1}^+) < d_{Y_i}(x, z)$ when $i = 0, k$.

If $d_{Y_i}(x, z) > K$ we have $d_{\mathcal{C}(\mathbf{Y})}(x_i^-, x_{i+1}^+) < 2d_{Y_i}(x, z)$ while if $d_{Y_i}(x, z) \leq K$ then $d_{\mathcal{C}(\mathbf{Y})}(x_i^-, x_{i+1}^+) < 2K$. We can write this as a single inequality

$$d_{\mathcal{C}(\mathbf{Y})}(x_i^-, x_{i+1}^+) < 2 \max\{K, d_{Y_i}(x, z)\}$$

that applies to both cases. Now

$$\begin{aligned} d_{\mathcal{C}(\mathbf{Y})}(x, z) &\leq kL + \sum d_{\mathcal{C}(Y)}(x_i^-, x_{i+1}^+) \\ &\leq L + 4 \sum_{i=1}^{k-1} d_{Y_i}(x, z) + 2 \sum_{i=0, k} \max\{K, d_{Y_i}(x, z)\} \\ &\leq 6K + 4 \sum_{Y \in \mathbf{Y}_K(x, z)} d_Y(x, z) \end{aligned}$$

□

We aim to find a lower bound in the spirit of Lemma 3.18 for the projection complex $\mathcal{P}_K(\mathbf{Y})$. See Theorem 4.13. We will need a version of Proposition 3.14 for $\mathcal{C}(\mathbf{Y})$. The proof will be a word for word repeat of Proposition 3.14 but first we need a new version of Lemma 3.10.

Lemma 4.5. *Let X_0 and X_1 be vertices in $\mathcal{P}_K(\mathbf{Y})$ with $d(X_0, X_1) = 1$ and let x_0 and x_1 be vertices in $\mathcal{C}(X_0)$ and $\mathcal{C}(X_1)$ such that $x_0 \in \pi_{X_0}(X_1)$ and $x_1 \in \pi_{X_1}(X_0)$. Let W be a vertex in \mathbf{Y} and w a vertex in $\mathcal{C}(W)$ with $d_{\mathcal{C}(\mathbf{Y})}(x_i, w) \geq 2L$. Then either*

$$d_W(x_0, x_1) \sim 0$$

or

$$d_W(x_i, w) \succ L \text{ for } i = 0, 1.$$

Proof. First assume $X_0 = W$. Since $x_0 \in \pi_W(x_1) = \pi_{X_0}(x_1)$ we have $d_W^\pi(x_0, x_1) \leq \text{diam}(\pi_W(X_1)) \sim 0$. Of course, we get the same bound if $X_1 = W$.

If either $d(X_0, W) \geq 2$ or $d(X_1, W) \geq 2$ then $d_W^\pi(x_0, x_1) = d_W^\pi(X_0, X_1) \sim 0$ by Lemma 3.10.

This leaves us with the case where $d(X_0, W) = d(X_1, W) = 1$. We first observe that if $d_{X_0}(X_1, W) > \Theta$ then $d_W(x_0, x_1) = d_W(X_0, X_1) \sim 0$. The same estimate holds if $d_{X_1}(X_0, W) > \Theta$.

The final sub-case is when both $d_{X_0}(X_1, W) \leq \Theta$ and $d_{X_1}(X_0, W) \leq \Theta$. It is here that we use the lower bound $d_{\mathcal{C}(\mathbf{Y})}(x_i, w) \geq 2L$. To do so we need the upper bound

$$d_{\mathcal{C}(\mathbf{Y})}(x_0, w) \leq d_{X_0}(x_0, w) + L + d_W(x_0, w)$$

which is obtained by taking the path made up of a path in $\mathcal{C}(X_0)$ connecting x_0 to $\pi_{X_0}(w)$, an edge from $\pi_{X_0}(W)$ to $\pi_W(X_0)$ and a path in $\mathcal{C}(W)$ from $\pi_W(X_0)$ to w . Since $x_0 \in \pi_{X_0}(X_1)$ we have $d_{X_0}(x_0, w) \prec d_{X_0}(X_1, W)$. Combining the bounds gives $d_W(x_0, w) \succ L$ and the same bound holds for $d_W(x_1, w)$. \square

Lemma 4.6. *For K sufficiently large the following holds. Let x_0 and x_1 be adjacent vertices in $\mathcal{C}(\mathbf{Y})$ and let Y be a vertex in $\mathcal{P}_K(\mathbf{Y})$ such that $d_{\mathcal{C}(\mathbf{Y})}(x_i, \mathcal{C}(Y)) \geq 3L$. If W is a guard for Y with $W \in \mathbf{Y}_{K/2}(x_0, Y)$ and $W \notin \mathbf{Y}_{K/2}(x_1, Y)$ then there exists a guard W' for Y with $W' \in \mathbf{Y}_{K/2}(x_1, Y)$ and $W \in \mathbf{Y}_\Theta(W', Y)$.*

Proof. Let X_0 and X_1 be the vertices of $\mathcal{P}_K(\mathbf{Y})$ such that $x_i \in \mathcal{C}(X_i)$. If $X_0 = X_1 \neq W$ then $W \in \mathbf{Y}_{K/2}(x_1, Y)$ and the lemma is vacuous. If $X_0 = X_1 = W$ then

$$\begin{aligned} 3L &\leq d_{\mathcal{C}(\mathbf{Y})}(x_i, \mathcal{C}(Y)) \\ &\leq d_{\mathcal{C}(\mathbf{Y})}(x_i, \pi_Y(W)) \\ &\leq d_W(x_i, Y) + L \end{aligned}$$

and therefore $d_W^\pi(x_i, \pi_W(Y)) \geq 2L$. Since $L \sim K$ if K is sufficiently large then $2L > K$ and $W \in \mathbf{Y}_{K/2}(x_1, Y)$, therefore the lemma is vacuous as well.

We now assume that $X_0 \neq X_1$. We can now apply Lemma 4.5 with w a point in $\pi_W(Y)$. Note that $d_{\mathcal{C}(\mathbf{Y})}(w, \mathcal{C}(Y)) = L$ so $d_{\mathcal{C}(\mathbf{Y})}(x_i, w) \geq 2L$.

Lemma 4.5 gives us two possibilities. First we may have $d_W(x_1, w) \succ L \succ K$ in which case $W \in \mathbf{Y}_{K/2}(x_1, Y)$ for K sufficiently large.

Therefore if $W \notin \mathbf{Y}_{K/2}(x_1, Y)$ then Lemma 4.5 gives $d_W(x_0, x_1) \sim 0$. For K sufficiently large the coarse triangle inequality then implies that $W \in \mathbf{Y}_\Theta(x_1, Y)$ as $W \in \mathbf{Y}_{K/2}(x_0, Y)$. Since W is a guard for Y every vertex in $\mathbf{Y}_K(x_1, Y)$ must be less than W in $\mathbf{Y}_\Theta(x_1, Y)$. Furthermore $\mathbf{Y}_K(x_1, Y)$ can't be empty for if it was then, as above, $d(x_1, \mathcal{C}(Y)) \leq d_{X_1}(x_1, Y) + L \leq K + L < 3L$ if K is sufficiently large. Therefore there must be elements ($\neq W$, could be $= X_1$) of $\mathbf{Y}_K(x_1, Y)$ that are less than W in $\mathbf{Y}_\Theta(x_1, Y)$. The rest of the proof now is a repeat of the proof of Lemma 3.12. Namely, we take W' to be the greatest element of $\mathbf{Y}_{K/2}(x_1, Y)$ that is less than W in $\mathbf{Y}_\Theta(x_1, Y)$. The proof that $W \in \mathbf{Y}_\Theta(W', Y)$ and that W' is a guard is exactly as in the proof of Lemma 3.12. \square

We define the notion of a *barrier* for a path in $\mathcal{C}(\mathbf{Y})$ just as we did for paths in $\mathcal{P}_K(\mathbf{Y})$. Namely, if $\{x_0, x_1, \dots, x_k\}$ is a path in $\mathcal{C}(\mathbf{Y})$ and Z a vertex in $\mathcal{P}_K(\mathbf{Y})$ then $Y \in \mathbf{Y}$ is a barrier between them if $Y \in \mathbf{Y}_\Theta(x_i, Z)$ for $i = 0, \dots, k$. Note that it is possible that $x_i \in \mathcal{C}(Y)$. If neither x_i nor x_j are in $\mathcal{C}(Y)$ then Theorem 3.3 implies that $d_Z(x_i, x_j) < \Theta$. If exactly one of the two is in $\mathcal{C}(Y)$ then $d_Z(x_i, x_j) < \Theta$ from the inequality on triples. If they are both in $\mathcal{C}(Y)$ then $d_Z(x_i, x_j) = \pi_Z(Y) < \Theta$ by (P0).

Proposition 4.7. *Let $\{x_0, x_1, \dots, x_k\}$ be a path in $\mathcal{C}(\mathbf{Y})$ and $Z \in \mathbf{Y}$ such that $d_{\mathcal{C}(\mathbf{Y})}(x_i, \mathcal{C}(Z)) \geq 3L$ for all i . Then there is a barrier C in \mathbf{Y} between the path and Z . In particular, $d_Z(x_0, x_i) < \Theta$.*

Proof. The proof is a word for word repeat of the proof of Proposition 3.14 with Lemma 3.12 replaced with Lemma 4.6 and the upper case X_i replaced with the lower case x_i . \square

Remark 4.8. It is not hard to derive Proposition 3.14 from Proposition 4.7. In particular a path in $\mathcal{P}_K(\mathbf{Y})$ that is 3 or more away from a vertex Z can be lifted to path in $\mathcal{C}(\mathbf{Y})$ that is $3L$ away from $\mathcal{C}(Z)$.

The next lemma establishes that the nearest point projection to $\mathcal{C}(Z)$ agrees, to within a bounded error, with the prescribed projections.

Lemma 4.9. *Let x be a vertex in $\mathcal{C}(\mathbf{Y})$, Z a vertex in $\mathcal{P}_K(\mathbf{Y})$ and z a nearest point in $\mathcal{C}(Z)$ to x in $\mathcal{C}(\mathbf{Y})$. Then*

$$d_Z(x, z) \prec 2K.$$

Proof. Let y be the last point in a geodesic from x to z such that $d_{\mathcal{C}(\mathbf{Y})}(z, y) = d_{\mathcal{C}(\mathbf{Y})}(y, \mathcal{C}(Z)) \geq 3L$. Then by Proposition 4.7, $d_Z(x, y) \sim 0$. The case that such y does not exist, i.e., $d_{\mathcal{C}(\mathbf{Y})}(z, x) < 3L$, will be discussed at the end.

If a path in $\mathcal{C}(\mathbf{Y})$ of length at most $kL - 1$ maps to a path in $\mathcal{P}_K(\mathbf{Y})$ then the image path will have length at most $k - 1$. By the way we chose y , $d_{\mathcal{C}(\mathbf{Y})}(z, y) \leq 4L - 1$. Therefore the geodesic from y to z will map to a path of length at most 3 (and at least 1) in $\mathcal{P}_K(\mathbf{Y})$. Let Y and Z' be the vertices of $\mathcal{P}_K(\mathbf{Y})$ such that $y \in \mathcal{C}(Y)$ and Z' is the last vertex in the path before Z . Since $d(Y, Z') \leq 2$, the coarse triangle inequality implies that $d_Z(Y, Z') \prec 2K$. (We are assuming $Z \neq Z'$ here, but the case $Z = Z'$ is similar and left to the reader.) Since Z' is the last vertex before Z we also have that $z \in \pi_Z(Z')$ and therefore $d_Z(z, y) \prec 2K$. Since $d_Z(x, y) \sim 0$, another application of the coarse triangle inequality then gives $d_Z(x, z) \prec 2K$ as claimed.

Now we are left with the case $d_{\mathcal{C}(\mathbf{Y})}(z, x) < 3L$. If $x \in \mathcal{C}(Z)$, then $z = x$ and there is nothing to prove. Otherwise, letting $y = x$ in the above discussion, we have $d_Z(z, x) \prec 2K$. \square

The nearest point projection $\mathcal{C}(\mathbf{Y}) \rightarrow \mathcal{C}(Z)$ is not really a function since the image of a point is not always a single point. However, it is a *coarse map*, i.e. the diameter of the image set is uniformly bounded by Lemma 4.9. Recall that a coarse map F between two metric spaces is *coarsely Lipschitz* if there exist constants $a, b > 0$ such that $\text{diam } F(A) \leq a \text{diam}(A) + b$.

Corollary 4.10. *For every $Z \in \mathbf{Y}$ the nearest point projection $\mathcal{C}(\mathbf{Y}) \rightarrow \mathcal{C}(Z)$ is coarsely Lipschitz and the image of $\mathcal{C}(Y)$ for $Y \neq Z$ is in a uniform neighborhood of the bounded set $\pi_Z(Y)$.*

Proof. Let x_1, x_2 be two vertices of $\mathcal{C}(\mathbf{Y})$ that are joined by an edge and say $x_i \in \mathcal{C}(X_i)$ for $i = 1, 2$. We need to argue that the images of x_i are uniformly close. There are several cases.

Case 1. x_1, x_2 are joined by an edge of length 1. Then $X_1 = X_2$ and the images of x_1, x_2 are uniformly close, by Lemma 4.9, to $\pi_Z(X_1) = \pi_Z(X_2)$.

Case 2. x_1, x_2 are joined by an edge of length L ; thus $d(X_1, X_2) = 1$. If $X_1 \neq Z \neq X_2$ then $d_Z(X_1, X_2) \leq K$ and we again see from Lemma 4.9 that the images of x_1 and x_2 are uniformly close. Finally, if $X_1 = Z \neq X_2$, then $x_1 \in \mathcal{C}(Z)$ is its own image, while the image of x_2 is at most $2L$ away. \square

Proof of Theorem A. This now follows from Lemma 4.2 and Corollary 4.10. \square

The next two statements say that $\mathcal{C}(\mathbf{Y})$ is a quasi-tree-like union of spaces $\mathcal{C}(Y)$.

Proposition 4.11. *Let $X, Z \in \mathbf{Y}$, $x \in \mathcal{C}(X)$, $z \in \mathcal{C}(Z)$. If $Y \in \mathbf{Y}_\Theta(x, z)$ then any path from x to z in $\mathcal{C}(\mathbf{Y})$ contains a vertex w such that*

- $d_{\mathcal{C}(\mathbf{Y})}(w, \mathcal{C}(Y)) < 3L$,
- $d_Y(x, w) \prec K$.

It follows that $d_{\mathcal{C}(\mathbf{Y})}(w, \pi_Y(x)) \prec 3L + 3K$. (A similar statement holds with z in place of x .)

Proof. By Proposition 4.7 every path from x to z must intersect the $3L$ -neighborhood of $\mathcal{C}(Y)$ if $Y \neq X, Z$. This is trivially true if $Y = X$ or $Y = Z$. Let w be the first vertex in the path with $d_{\mathcal{C}(\mathbf{Y})}(w, \mathcal{C}(Y)) < 3L$ and let w' be the vertex that precedes it. (If $w = x$ then the lemma holds trivially.) By Proposition 4.7, $d_Y(x, w') \sim 0$. Since w and w' are adjacent in $\mathcal{C}(\mathbf{Y})$ they will map to either adjacent vertices in $\mathcal{P}(\mathbf{Y})$ or the same vertex. In either case $d_Y(w, w') \prec K$ and by the coarse triangle inequality $d_Y(x, w) \prec K$.

Now let $\tilde{w} \in \mathcal{C}(Y)$ be a nearest point from w to $\mathcal{C}(Y)$. We have $d_{\mathcal{C}(\mathbf{Y})}(w, \tilde{w}) < 3L$. By Lemma 4.9, $d_Y(\tilde{w}, w) \prec 2K$. Therefore by the coarse triangle inequality $d_{\mathcal{C}(\mathbf{Y})}(w, \pi_Y(x)) \prec 3L + 2K + K$. \square

Lemma 4.12. *There exists $K' > 0$ so that the following holds. If $x \in \mathcal{C}(X)$, $z \in \mathcal{C}(Z)$, and $Y \in \mathbf{Y}_{K'}(x, z)$, then every geodesic V in $\mathcal{C}(\mathbf{Y})$ from x to z intersects $\mathcal{C}(Y)$ in a geodesic segment $[v, w]$ and moreover $d_Y(x, v) \prec K'$, $d_Y(z, w) \prec K'$. Y is possibly X or Z .*

Proof. First note that by Lemma 4.2 the intersection, if nonempty, is a geodesic segment (possibly a single point). From Proposition 4.11 it follows that there are points v', w' along V so that $d(v', \pi_Y(x)) \prec 3L + 3K$ and $d(w', \pi_Y(z)) \prec 3L + 3K$. In particular, $d(v', w') \prec 6L + 6K + d_Y(x, z)$.

Assuming the subsegment $[v', w'] \subset V$ is disjoint from $\mathcal{C}(Y)$, we estimate the number of $\mathcal{C}(W)$'s $[v', w']$ has to pass through as being at least $\frac{d_Y(x, z)}{K} - 1$ (the diameter of the projections to Y of the union of two consecutive $\mathcal{C}(W)$'s is at most K). Thus the number of edges of length L the segment passes through is at least $\frac{d_Y(x, z)}{K}$, and we have

$$\frac{Ld_Y(x, z)}{K} \prec 6L + 6K + d_Y(x, z)$$

Since $L/K > 1$ we get a contradiction when $d_Y(x, z)$ is large enough. We have shown that if K' is large enough then $[v', w'] \cap \mathcal{C}(Y) \neq \emptyset$.

Thus $[v', w'] \cap \mathcal{C}(Y)$ is a geodesic segment $[v, w]$. We will argue that v is uniformly close to $\pi_Y(x)$; the argument that w is uniformly close to $\pi_Y(z)$ is symmetric. Let v'' be the vertex on the segment $[x, v] \subset V$ immediately preceding v (if $x = v$ there is nothing to prove). If $d(\pi_Y(x), \pi_Y(v'')) > K'$ we may apply the argument of the preceding paragraph to the geodesic $[x, v'']$ to deduce $[x, v''] \cap \mathcal{C}(Y) \neq \emptyset$, a contradiction. Thus $d(\pi_Y(x), \pi_Y(v'')) \leq K'$ and so $d_Y(x, v) \prec K'$. \square

The following is the distance estimate analogous to the Masur-Minsky formula.

Theorem 4.13. *There is $K' > K$ such that for $x \in \mathcal{C}(X), z \in \mathcal{C}(Z)$*

$$\frac{1}{2} \sum_{W \in \mathbf{Y}_{K'}(x, z)} d_W(x, z) \leq d_{\mathcal{C}(\mathbf{Y})}(x, z) \leq 6K + 4 \sum_{W \in \mathbf{Y}_K(x, z)} d_Y(x, z)$$

Proof. The upper bound is Lemma 4.4. Let K' be the constant from Lemma 4.12 and assume that $d_Y(x, z) > 6K'$. Then any geodesic from x to z intersects $\mathcal{C}(Y)$ in a segment of length $\succ 4K'$, which is $> 3K'$. The estimate follows after renaming $6K'$ to K' . \square

4.3 Hyperbolicity of $\mathcal{C}(\mathbf{Y})$

In this section we prove that if all $\mathcal{C}(Y)$ uniformly satisfy the bottleneck property, or hyperbolicity, or quasi-convexity, then $\mathcal{C}(\mathbf{Y})$ satisfies the same property.

Theorem 4.14. *Suppose that all $\mathcal{C}(Y)$ for $Y \in \mathbf{Y}$ are quasi-trees in a uniform way, so that there is Δ such that all $\mathcal{C}(Y)$ for $Y \in \mathbf{Y}$ satisfy the bottleneck property with this Δ . Then $\mathcal{C}(\mathbf{Y})$ satisfies the bottleneck property so it is a quasi-tree.*

Proof. Let $x \in \mathcal{C}(X)$ and $z \in \mathcal{C}(Z)$ be given and let Y_1, Y_2, \dots, Y_s be the elements of $\mathbf{Y}_K(X, Z)$ with indexing reflecting the order. There is a standard path (see the proof of Lemma 4.4) V in $\mathcal{C}(\mathbf{Y})$ from x to z that projects to $\{X, Y_1, Y_2, \dots, Y_s, Z\}$ and within each $\mathcal{C}(Y_i)$ (we let $Y_0 = X, Y_{s+1} = Z$) it is a geodesic. We will argue that any path U from x to z comes within a bounded distance from any point on V . This verifies the modified bottleneck property discussed just before Theorem D.

Fix a point $v \in \mathcal{C}(Y_i)$ on V and let $\{x = x_0, x_1, \dots, x_k = z\}$ be the vertices of an arbitrary path U between x and z . We project the x_j to Y_i and let y_j be points in $\pi_{Y_i}(x_j)$. Note that $d_{\mathcal{C}(Y_i)}(y_j, y_{j+1}) \prec K$ so the y_j form a coarse path in $\mathcal{C}(Y_i)$ from $y_0 = \pi_{Y_i}(x)$ to $y_k = \pi_{Y_i}(z)$. Since $\mathcal{C}(Y_i)$ satisfies the bottleneck property with constant Δ , $d(y_0, \pi_{Y_i}(Y_{i-1})) \sim 0$ and $d(y_k, \pi_{Y_i}(Y_{i+1})) \sim 0$ by the order property, there will be some y_ℓ with $d_{\mathcal{C}(Y_i)}(y_\ell, v) \prec \Delta + K$. Note that if K is sufficiently large then at least one of $d_{Y_i}(x, x_\ell)$ and $d_{Y_i}(z, x_\ell)$ must be large enough to apply Proposition 4.11. Assume it is the former. Applying Proposition 4.11 there exists a vertex $x_{\ell'}$ on the path between x and x_ℓ such that

$$d_{\mathcal{C}(\mathbf{Y})}(x_{\ell'}, \mathcal{C}(Y_i)) < 3L$$

and

$$d_{Y_i}(y_\ell, x_{\ell'}) \prec K$$

since $y_\ell \in \pi_{Y_i}(x_\ell)$. Let $w \in \mathcal{C}(Y_i)$ be the closest point in $\mathcal{C}(\mathbf{Y})$ to $x_{\ell'}$. Then by Lemma 4.9 and the coarse triangle inequality we have

$$d_{Y_i}(w, v) \prec d_{Y_i}(w, x_{\ell'}) + d_{Y_i}(x_{\ell'}, y_\ell) + d_{Y_i}(y_\ell, v) \prec \Delta + 4K$$

and, since $d_{\mathcal{C}(\mathbf{Y})}(w, x_{\ell'}) < 3L$,

$$d_{\mathcal{C}(\mathbf{Y})}(x_{\ell'}, v) \prec \Delta + 4K + 3L.$$

This proves that the bottleneck property holds since $x_{\ell'} \in U$. \square

A geodesic metric space is *quasi-convex* if there is $N > 0$ such that for any two geodesic segments $[u, v]$ and $[u', v']$, if $d(u, u') \leq 1$ and $d(v, v') \leq 1$ then $[u', v']$ is contained in the Hausdorff N -neighborhood of $[u, v]$. Note that this implies that if $d(u, u') \leq C$, $d(v, v') \leq C$ then $[u', v']$ is contained in the Hausdorff $(C + 1)N$ -neighborhood of $[u, v]$.

Also note that if each $\mathcal{C}(Y)$ is quasi-convex with the same constant (then we say *uniformly quasi-convex*), then there is a uniform bound on the Hausdorff distance of any two standard paths between any two points in $\mathcal{C}(\mathbf{Y})$.

Lemma 4.15. *Suppose that each $\mathcal{C}(Y)$ is quasi-convex with the same constant N . There is $M > 0$ so that for any x and z , the Hausdorff distance between any geodesic from x to z and any standard path (see Definition 4.3) from x to z is at most M .*

Proof. If $[v, w]$ is a segment in a standard path U obtained by intersecting with some $\mathcal{C}(W)$, then the endpoints are within uniform distance of any geodesic V from x to z by Proposition 4.11 since $W \in \mathbf{Y}_\Theta(x, z)$ (the only case the lemma does not apply is when $W = X, Z$ and $W \notin \mathbf{Y}_\Theta(x, z)$, but then the claim is true with the bound Θ). We claim that $[v, w]$ is within uniform distance from V . If $d_W(x, z) \leq K'$, then the length of the geodesic $[v, w]$ is bounded by a constant $\prec 3K'$, therefore $[v, w]$ is within uniform distance from V . If $d_W(x, z) > K'$, then by Lemma 4.12 V intersects $\mathcal{C}(Y)$ in a geodesic segment $[v', w']$ whose endpoints are uniform distance from the endpoints of $[v, w]$. By the uniform quasi-convexity of $\mathcal{C}(Y)$, the claim follows. Thus the standard path U is contained in a uniform neighborhood of the geodesic V .

Now we show that the geodesic V is contained in a uniform neighborhood of the standard path U . Let $\mathbf{Y}_K(x, z) = \{Y_1, Y_2, \dots, Y_k\}$ and let $i_1 < i_2 < \dots < i_s$ be the indices of those Y_i with $d_{Y_i}(x, z) > K'$, where K' is large (at least as large as in Lemma 4.12, but in fact a bit larger, see below). Then $V \cap \mathcal{C}(Y_{i_j})$ is an interval I_{i_j} and the intervals $I_{i_1}, I_{i_2}, \dots, I_{i_s}$ occur along V in order of their indices (if I_{i_j} occurs after $I_{i_{j+1}}$ apply Lemma 4.12 to the subsegment of V that starts with I_{i_j} to get a contradiction – this is where we need K' to be larger by Θ than in Lemma 4.12). Let I'_{i_j} be the geodesic segment $\mathcal{C}(Y_{i_j}) \cap U$. Since U is a standard path, the endpoints of I'_{i_j} are within distance $\prec \Theta$ from $\pi_{Y_{i_j}}(x), \pi_{Y_{i_j}}(z)$, respectively. Also, by Lemma 4.12, the endpoints of I_{i_j} are within distance $\prec K'$ from $\pi_{Y_{i_j}}(x), \pi_{Y_{i_j}}(z)$, respectively. Therefore, I_{i_j} and I'_{i_j} are contained in a uniform neighborhood of each other by the uniform quasi-convexity of $\mathcal{C}(Y)$. It suffices to argue that each complementary interval in V and the corresponding (with respect to the order) complementary interval in U are contained in a uniform neighborhood of each other.

Let J be one such complementary interval, say between I_{i_j} and $I_{i_{j+1}}$. The corresponding interval J' in U is between I'_{i_j} and $I'_{i_{j+1}}$. We already know the endpoints of J and J' are uniformly close. Note that $Y_i \in \mathbf{Y}_\Theta(Y_{i_j}, Y_{i_{j+1}})$ for $i_j < i < i_{j+1}$, so applying Proposition 4.11 again to J we find that each endpoint r_m of each segment of J' in the standard path within some $\mathcal{C}(Y_i)$ is within uniform distance of some point R_m on J . (The bound is perhaps worse than $3L + 3K$ since the endpoints of J and J' do not exactly coincide,

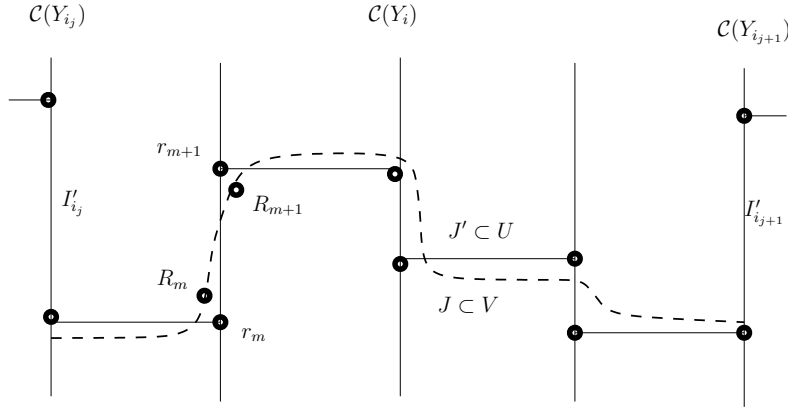

Figure 7: Lemma 4.15. J is the dashed line

but they are uniformly close, which is enough.) Index the points r_m in order in which they occur along the standard path, and note that we do not know that the corresponding points R_m appear in linear order along J . However, since $d(r_m, r_{m+1})$ is uniformly bounded (by $L + K'$), it follows that $d(R_m, R_{m+1})$ is uniformly bounded. Moreover, the first point R_1 and the last point R_n are within a uniform distance of the corresponding endpoints of J . It follows that the R_m 's cut J into segments of bounded length and also r_m 's cut J' into segments of bounded length, therefore J and J' are contained in a uniform neighborhood of each other, and the lemma follows.

The extremal cases, when J contains an endpoint of V , differs only in notation and is left to the reader. \square

Remark 4.16. A similar argument shows that $\mathcal{C}(\mathbf{Y})$ is quasi-convex.

Recall that a geodesic metric space is δ -hyperbolic if for any three points x, y, z any geodesic $[x, z]$ is contained in the δ -neighborhood of the union $[x, y] \cup [y, z]$ of any two geodesics joining x to y and y to z . A space is hyperbolic if it is δ -hyperbolic for some δ .

Theorem 4.17. *Assume that each $\mathcal{C}(Y)$ is δ -hyperbolic with the same δ . Then $\mathcal{C}(\mathbf{Y})$ is hyperbolic.*

Proof. Let x, y, z be three vertices of $\mathcal{C}(\mathbf{Y})$. Recall that δ -hyperbolic spaces are quasi-convex, with the constant depending only on δ . Thus Lemma 4.15 applies and it suffices to show that a standard path U from x to z is contained in a uniform neighborhood of the union of two geodesics $[x, y]$ and $[y, z]$.

Let $W \in \mathbf{Y}_K(x, z)$. We claim that $[\pi_W(x), \pi_W(z)]$ is contained in a uniform neighborhood of $[x, y] \cup [y, z]$. First consider the case when $d_W(x, y) > \Theta$, $d_W(y, z) > \Theta$. Then a geodesic $[\pi_W(x), \pi_W(y)] \subset \mathcal{C}(W)$ is contained in a uniform neighborhood of $[x, y]$ by Proposition 4.11 and Lemma 4.12 (see the first paragraph of the proof of Lemma 4.15). Likewise, a geodesic $[\pi_W(y), \pi_W(z)]$ is contained in a uniform neighborhood of $[y, z]$. Since $\mathcal{C}(W)$ is δ -hyperbolic, $[\pi_W(x), \pi_W(z)]$ is contained in the δ -neighborhood of $[\pi_W(x), \pi_W(y)] \cup [\pi_W(y), \pi_W(z)]$ and consequently in a uniform neighborhood of $[x, y] \cup [y, z]$.

Now suppose that $d_W(x, y) \leq \Theta$. Since $W \in \mathbf{Y}_K(x, z)$, it follows $d_W(y, z) > \Theta$. Again by Proposition 4.11 and Lemma 4.12 we have that $[\pi_W(y), \pi_W(z)]$ is in a uniform neighborhood of $[y, z]$. By quasi-convexity, it follows from $d_{\mathcal{C}(\mathbf{Y})}(\pi_W(x), \pi_W(y)) \leq \Theta$ that $[\pi_W(x), \pi_W(z)]$ is contained in a uniform neighborhood of $[\pi_W(y), \pi_W(z)]$ and hence of $[y, z]$. The case when $d_W(y, z) \leq \Theta$ is handled symmetrically.

By the definition of a standard path and the uniform quasi-convexity of $\mathcal{C}(Y)$, a standard path U from x to z is contained in a uniform neighborhood of the union of $[\pi_W(x), \pi_W(z)]$ for all W with $W \in \mathbf{Y}_K(x, z)$ (see the proof of Lemma 4.15). Therefore it follows that U is contained in a uniform neighborhood of $[x, y] \cup [y, z]$. \square

4.4 Group action and WWPD

Now assume that G is a group that acts on the set \mathbf{Y} , that for each $Y \in \mathbf{Y}$ we have a geodesic metric space $\mathcal{C}(Y)$ and projections π_Y satisfying the axioms (P0), (P1), (P2), and that G preserves this structure, i.e. there are isometries $F_g^Y : \mathcal{C}(Y) \rightarrow \mathcal{C}(g(Y))$ so that

- $F_{g'}^{g(Y)} F_g^Y = F_{g'g}^Y$ for all $g, g' \in G$, $Y \in \mathbf{Y}$, and
- $\pi_Y(X) = \pi_{g(Y)}(g(X))$ for all $g \in G$ and $X, Y \in \mathbf{Y}$.

Then projection distances are preserved, i.e. $d_{g(A)}^\pi(g(B), g(C)) = d_A^\pi(B, C)$ for all $A, B, C \in \mathbf{Y}$ and $g \in G$, and therefore G acts naturally on $\mathcal{C}(\mathbf{Y})$. To simplify notation, we will denote the isometry F_g^Y simply by $g : \mathcal{C}(Y) \rightarrow \mathcal{C}(g(Y))$.

We defined WPD for group actions in Section 3.7. Here we define a weaker property, *WWPD*, to allow for elements with large centralizers. We restrict ourselves to actions on hyperbolic spaces. For a motivation, see Remark 2.2.

Let G act on a δ -hyperbolic metric space X . A hyperbolic element $g \in G$ has a *quasi-axis*, which is a g -invariant quasi-geodesic. As before the *elementary closure* of g (in G), $EC(g)$, is the subgroup in G of elements h such that $h(\gamma)$ is parallel to γ . (We can define the elementary closure of g in a subgroup of G .) Equivalently, it is the stabilizer of the set of $\gamma(\pm\infty)$, the points at infinity of γ . The elementary closure does not depend on the choice of γ .

Definition 4.18. Let G act on a δ -hyperbolic metric space X . We say $g \in G$ is a *WWPD element* if

- (1) g acts as a hyperbolic isometry on X ,
- (2) there is $x \in X$, a subgroup $N \subset G$ with $g \in N$ and a constant $B > 0$ such that
 - for $h \in G - N$ the projection of $h(\langle g \rangle x)$ to $\langle g \rangle x$ has diameter $\leq B$,
 - N is contained in $EC(g)$, and there is a homomorphism $N \rightarrow Q$ to a virtually cyclic group Q whose kernel fixes every $g^k(x)$, $k \in \mathbb{Z}$.

Moreover, if each element of N fixes the points $\gamma(\pm\infty)$ pointwise, then we say g is a *WWPD⁺* element.

Remark 4.19. This definition is not independent of the choice of x . The set of translates of the g -orbit of x is again “discrete” as in the definition of WPD, but this time we allow a big group that fixes the whole orbit pointwise. Note that the image of $\langle g \rangle$ in Q has finite index.

Proposition 4.20. *Suppose each $\mathcal{C}(Y)$ is δ -hyperbolic so that $\mathcal{C}(\mathbf{Y})$ is hyperbolic. Let $g \in G$ so that $g(Y) = Y$ and denote by $K_{\mathcal{C}(Y)}$ the kernel of the action of $Stab_G(Y)$ on $\mathcal{C}(Y)$. Assume that $g : \mathcal{C}(Y) \rightarrow \mathcal{C}(Y)$ is a hyperbolic WPD element for the action of $Stab_G(Y)/K_{\mathcal{C}(Y)}$ on $\mathcal{C}(Y)$. Then g is a WWPD element for the action of G on $\mathcal{C}(\mathbf{Y})$. If moreover $Stab_G(Y)$ is virtually cyclic then g is a WPD element for the action of G on $\mathcal{C}(\mathbf{Y})$.*

Proof. We take N to be $EC(g)$. Then $K_{\mathcal{C}(Y)} < N < Stab_G(Y)$. The first inclusion is clear and the second one follows from Corollary 4.10 since a quasi-axis of g is contained in $\mathcal{C}(Y)$.

Define $Q := N/K_{\mathcal{C}(Y)}$ with the obvious quotient map $N \rightarrow Q$, and we choose $x \in \mathcal{C}(Y)$. Note that N is also the elementary closure of g in $Stab_G(Y)$ and since g is WPD in $Stab_G(Y)/K_{\mathcal{C}(Y)}$, Q is virtually cyclic. If $h \in G - N$ then either $h \notin Stab_G(Y)$ and it moves the orbit $\langle g \rangle x$ to another $\mathcal{C}(Y')$ and the projection to $\mathcal{C}(Y)$ is uniformly bounded by Corollary

4.10, or $h \in \text{Stab}_G(Y)$ and the projection to $\langle g \rangle x$ is bounded by the WPD assumption by Theorem H (as we said after Theorem H, WPD implies that since $h \notin N$ the projection of $h(\langle g \rangle x)$ to $\langle g \rangle x$ satisfies (P0), namely, it is uniformly bounded). Therefore g is WWPD.

For the moreover part, note that under the assumption on $\text{Stab}_G(Y)$, $\langle g \rangle$ has finite index in this group. On the other hand the set of elements in G in the definition of WPD (elements that almost fix two points at a large distance on a quasi-axis of g) is contained in $\text{Stab}_G(Y)$ by Corollary 4.10, therefore the concerned set is finite, hence g is WPD. \square

Examples 4.21 (WPD and WWPD). Let G be a discrete group of isometries of \mathbb{H}^n and \mathbf{Y} the collection of translates of the axes of a hyperbolic element γ of G , as in Example 2.1(1). Then γ is a WPD element of $\mathcal{C}(\mathbf{Y})$, where $\mathcal{C}(Y) \cong \mathbb{R}$ is the axis Y . Similar conclusions hold in the other examples.

We will see examples of WWPD elements in Section 5.3. Elements $g \in MCG$ that are pseudo-Anosov when restricted to a subsurface Y (or Dehn twists when Y is an annulus) will be WWPD elements, but not WPD in general, for the action of the mapping class group on $\mathcal{C}(\mathbf{Y}^i)$, where $Y \in \mathbf{Y}^i$. To be precise we may only have the action on the color preserving subgroup in Lemma 5.7, and assume g is contained in the subgroup otherwise take a finite power to satisfy this. To verify that g is WWPD is immediate from Proposition 4.20 since g is WPD for the action of $MCG(Y)$ on the curve complex of Y . In fact, g is $WWPD^+$ (see [BBFc]).

4.5 Asymptotic dimension

In this section we will show that if the collection of spaces $\mathcal{C}(Y)$ has asymptotic dimension $\leq n$ uniformly, then $\text{asdim} \mathcal{C}(\mathbf{Y}) \leq n + 1$.

Asymptotic dimension is invariant under quasi-isometries (or even a *coarse invariant*). In particular, asymptotic dimension of a finitely generated group is well-defined. A general reference for asymptotic dimension is [BD08]; in connection to the coarse setting see [Roe03]; for the original definition and an interesting discussion see Gromov's article [Gro93].

We now review some basic facts. We will need the following theorem.

Bell-Dranishnikov's Hurewicz Theorem [BD06]. *Let $f : \mathcal{X} \rightarrow \mathcal{Y}$ be a Lipschitz map with \mathcal{X} a geodesic space. Suppose that there exists n such that for every R the family $\{F_y = f^{-1}(B(y, R)) \mid y \in \mathcal{Y}\}$ has $\text{asdim}(F_y) \leq n$ uniformly. Then $\text{asdim}(\mathcal{X}) \leq \text{asdim}(\mathcal{Y}) + n$.*

This should be thought of as a generalization of the **Product Formula**,

$$\text{asdim}(\mathcal{X} \times \mathcal{Y}) \leq \text{asdim}(\mathcal{X}) + \text{asdim}(\mathcal{Y}).$$

For example, if $1 \rightarrow A \rightarrow B \rightarrow C \rightarrow 1$ is a short exact sequence of finitely generated groups then $\text{asdim}(B) \leq \text{asdim}(A) + \text{asdim}(C)$. Likewise, asymptotic dimension of the hyperbolic plane is ≤ 2 by considering the projection to a line whose fibers are horocycles tangent to a fixed point at infinity (e.g. the projection to the y -coordinate in the upper half-space model). More generally one can apply this argument to a semi-simple Lie group and its associated symmetric space (see [BD08] for precise statements).

We will also use the following theorem.

Union Theorem. *Let $n \geq 0$ be an integer, $\mathcal{X} = \cup \mathcal{X}_\alpha$ and assume that $\text{asdim}(\mathcal{X}_\alpha) \leq n$ uniformly. Also assume that for every $R > 0$ there is a subset $\mathcal{Y}_R \subset X$ such that $\text{asdim}(\mathcal{Y}_R) \leq n$ and the sets $\mathcal{X}_\alpha \setminus \mathcal{Y}_R$ and $\mathcal{X}_\beta \setminus \mathcal{Y}_R$ are R -separated for $\alpha \neq \beta$ (i.e. $d(x, y) > R$ for any $x \in \mathcal{X}_\alpha \setminus \mathcal{Y}_R$ and $y \in \mathcal{X}_\beta \setminus \mathcal{Y}_R$). Then $\text{asdim}(\mathcal{X}) \leq n$. Furthermore the uniformity constants for $\text{asdim}(\mathcal{X})$ only depend on the uniformity constants for \mathcal{X}_α and \mathcal{Y}_R .*

Remark 4.22. The uniformity statement is not in [BD08] but is easily seen from the proof.

We noted above that asymptotic dimension is not only a quasi-isometric invariant but is also a *coarse invariant*, in particular $\text{asdim}(\mathcal{X}) \leq \text{asdim}(\mathcal{Y})$ if there exists a coarse embedding $f : \mathcal{X} \rightarrow \mathcal{Y}$ ([Roe03]).

Using this fact will simplify our proof that the asymptotic dimension of the mapping class group is finite.

4.6 $\mathcal{C}(\mathbf{Y})$ has finite asymptotic dimension

We would like to show that $\mathcal{C}(\mathbf{Y})$ has finite asymptotic dimension under the assumption that the asymptotic dimensions of the spaces $\mathcal{C}(Y)$ are uniformly bounded. To do so we will apply the Bell-Dranishnikov Hurewicz Theorem to the map from $\mathcal{C}(\mathbf{Y})$ to $\mathcal{P}_K(\mathbf{Y})$. The theorem is most natural to apply when the pre-images of balls are Hausdorff neighborhoods of pre-images of points. This is not the case in our situation and we need the following technical lemma to deal with this issue.

Lemma 4.23. *Fix a vertex Y in $\mathcal{P}_K(\mathbf{Y})$. Given $R > 0$ and distinct vertices X and Z with $d(X, Y) = d(Z, Y) = m$ and $x \in \mathcal{C}(X)$, $z \in \mathcal{C}(Z)$ with $d_{\mathcal{C}(\mathbf{Y})}(x, z) < R$, then there exist a vertex X_1 with $d(X_1, Y) = m - 1$ and $d_{\mathcal{C}(\mathbf{Y})}(x, X_1) < R + 2mL + \theta$.*

Proof. By Lemma 4.2 we have $d_Y^\pi(x, z) \leq R$. Since $d(X, Y) = d(Z, Y) = m$ there is a path $X = X_0, X_1, \dots, X_N = Z$ in $\mathcal{P}_K(\mathbf{Y})$ of length $N \leq 2m$ with $d(X_1, Y) = m - 1$. By Lemma 4.2, for adjacent vertices in $\mathcal{P}_K(\mathbf{Y})$ we have $d_X^\pi(X_i, X_{i+1}) < d_{\mathcal{C}(\mathbf{Y})}(X_i, X_{i+1}) = L$ so the triangle inequality implies that $d_X^\pi(X_1, Z) < (2m - 1)L$ and

$$\begin{aligned} d_X^\pi(x, X_1) &< d_X^\pi(x, Z) + d_X^\pi(Z, X_1) \leq d_X^\pi(x, z) + \theta + d_X^\pi(Z, X_1) \\ &< R + (2m - 1)L + \theta. \end{aligned}$$

By the definition of $d_X^\pi(x, X_1)$ the distance in $\mathcal{C}(X)$ from x to any point $\pi_X(X_1)$ is not more than $d_X^\pi(x, X_1)$. Furthermore there is an edge in $\mathcal{C}(\mathbf{Y})$ from any point in $\pi_X(X_1)$ to $\mathcal{C}(X_1)$ of length L and therefore the distance from x to $\mathcal{C}(X_1)$ in $\mathcal{C}(\mathbf{Y})$ is less than $R + 2mL + \theta$. The lemma is proved. \square

Theorem 4.24. *If the metric spaces $\mathcal{C}(Y)$ for $Y \in \mathbf{Y}$ have asymptotic dimension uniformly bounded by n then $\mathcal{C}(\mathbf{Y})$ has asymptotic dimension $\leq n + 1$.*

Proof. Consider the projection map $p : \mathcal{C}(\mathbf{Y}) \rightarrow \mathcal{P}_K(\mathbf{Y})$. The target is a quasi-tree so its asymptotic dimension is ≤ 1 . We will verify the conditions of Bell-Dranishnikov's Hurewicz Theorem for p . Let B_m denote the ball of radius m in $\mathcal{P}_K(\mathbf{Y})$ (centered at some vertex). We will prove by induction on m that $\text{asdim}(p^{-1}(B_m)) \leq n$. Uniformity is not an issue since all of our choices of constants will be independent of the vertex in $\mathcal{P}_K(\mathbf{Y})$. When $m = 0$ this is true by definition of n .

Now suppose $\text{asdim}(p^{-1}(B_m)) \leq n$ and we will argue $\text{asdim}(p^{-1}(B_{m+1})) \leq n$. To that end, we write

$$p^{-1}(B_{m+1}) = \bigcup_{Y \in B_{m+1}} p^{-1}(Y)$$

and check that the hypotheses of the Union Theorem hold. Each $p^{-1}(Y)$ has $\text{asdim} \leq n$ by definition of n .

Let R be given and set

$$\mathcal{Y}_R = N_{\tilde{R}}(p^{-1}(B_m))$$

the Hausdorff \tilde{R} -neighborhood of $p^{-1}(B_m)$, where

$$\tilde{R} = R + (2m + 2)L + \theta.$$

By induction, $p^{-1}(B_m)$, and hence \mathcal{Y}_R , have $\text{asdim} \leq n$. If X and Z are distinct vertices at distance $m + 1$ from the center of B_{m+1} then by Lemma

4.23, $p^{-1}(X) - \mathcal{Y}_R$ and $p^{-1}(Z) - \mathcal{Y}_R$ are R -separated. It now follows from Bell-Dranishnikov's Hurewicz Theorem that

$$\text{asdim}(\mathcal{C}(\mathbf{Y})) \leq n + 1.$$

□

Question 4.25. *Is $\text{asdim}(\mathcal{C}(\mathbf{Y})) \leq n$?*

5 Mapping class group

We now apply our tools to the study of the mapping class group. In this final section we will prove Theorems C, D, E, F and G mentioned in the introduction.

5.1 Curve complexes

We will apply our previous work to a collection of curve graphs of a subsurface of a fixed surface Σ , as in the work of Masur and Minsky [MM99], [MM00]. We begin by recalling the definition of the curve graph and projections. We follow an approach that is not standard but is convenient.

Let Σ be a compact orientable surface with boundary such that $\chi(\Sigma) < 0$, possibly with finitely many punctures (to be precise we mean compact after we fill in the punctures). Let $\mathcal{C}_0(\Sigma)$ be the set of homotopy classes of simple closed curves and properly embedded simple arcs that are not peripheral or boundary compressible. We then define the *curve graph*, $\mathcal{C}(\Sigma)$, to be the 1-complex obtained by attaching an edge to disjoint closed curves or arcs in $\mathcal{C}_0(\Sigma)$. We could also attach higher dimensional simplices but the resulting complex is quasi-isometric to its 1-skeleton so we stop at the curve graph.

Remark 5.1. The graph we have constructed is often called the *curve and arc graph*, [MM00]. The usual curve graph is quasi-isometric to the curve and arc graph and so we will use the less cumbersome name of curve graph. We also note that in the usual definition of the curve graph there are exceptional cases, the punctured torus and the sphere with 3 or 4 punctures, where the graph needs to be defined differently. One advantage of the curve-arc graph is that one definition works for all cases.

We also note that if Σ is a 3-punctured sphere then $\mathcal{C}(\Sigma)$ is bounded and we could ignore such subsurfaces. However there is also no harm in including them.

We now define projections between curve graphs of essential (i.e. connected, boundary components essential and nonperipheral) subsurfaces of Σ . If Y and Z are essential subsurfaces, we can only define the projection of $\mathcal{C}(Z)$ to $\mathcal{C}(Y)$ if ∂Z intersects Y essentially. We then define the *subsurface projection* $\pi_Y(Z) \subset \mathcal{C}(Y)$ by taking the intersection of ∂Z with Y and identifying homotopic curves and arcs. If z is vertex in $\mathcal{C}(Z)$ then we define $\pi_Y(z) = \pi_Y(Z)$.

We will also need the curve graph for a simple closed curve. The definition here has a somewhat different flavor although once we make the definition we can use it just as we do for the other curve complexes. The simplest way to define the curve graph is to fix a complete hyperbolic metric on the interior of Σ . If γ is an essential non-peripheral simple closed curve let X_γ be the annular cover of Σ to which γ lifts. Let $\mathcal{C}_0(\gamma)$ be the set of complete geodesics in X_γ that cross the core curve and we form $\mathcal{C}(\gamma)$ by attaching an edge to vertices that represent disjoint geodesics. It is easy to check that the distance in $\mathcal{C}(\gamma)$ is the intersection number plus one and that $\mathcal{C}(\gamma)$ is quasi-isometric to \mathbb{Z} .

We now define projections to and from $\mathcal{C}(\gamma)$. If Y is an essential subsurface such that ∂Y intersects γ let $\pi_\gamma(Y)$ be those components of the pre-image of the geodesic representatives of ∂Y in X_γ that intersect the core curve. If β is a simple closed curve that intersects γ we similarly define $\pi_\gamma(\beta)$ where we replace the ∂Y with β . Finally if γ intersects Y essentially then define $\pi_Y(\gamma)$ by restricting γ to Y .

With these definitions in hand we will not distinguish between essential subsurfaces and simple closed curves.

Since by definition $\pi_X(Y)$ is a collection of disjoint curves and arcs we have $\text{diam } \pi_X(Y) \leq 1$, which verifies Axiom (P0).

The following lemma (without the explicit bound) was proved by Behrstock [Beh06] using the Masur-Minsky theory of hierarchies [MM00]. For a simple proof due to Leininger that produces the explicit bound below see [Mang10, Mang13].

We say that subsurfaces X and Y *overlap* if $\partial X \cap \partial Y \neq \emptyset$ (this means that ∂X and ∂Y cannot be made disjoint by a homotopy). Note that in that case $\pi_X(Y)$ and $\pi_Y(X)$ are defined.

Lemma 5.2 (Axiom P1). *Let X, Y and Z be overlapping subsurfaces. If*

$$d_X^\pi(Y, Z) > 10$$

then

$$d_Y^\pi(X, Z) < 10.$$

We also have a finiteness statement for the number of large projections between two overlapping subsurfaces. The statement we require was proved in [MM00] using their hierarchy technology. For completeness we give a more direct proof here. While not necessary for our applications we note that the proof below, unlike in [MM00], gives an explicit constant that is independent of the complexity of the surface.

Lemma 5.3 (Axiom P2). *Given subsurfaces X and Y there are only finitely many subsurfaces Z with $d_Z^\pi(X, Y) > 3$.*

Proof. More generally, we will prove that if x, y are two arcs or curves then there are only finitely many subsurfaces Z with $d_Z^\pi(x, y) > 3$. The proof is in the spirit of Leininger's proof of (P1).

First assume that x, y fill the surface. Suppose Z is a subsurface such that $\partial Z, x, y$ are all in minimal position and without triple intersections. Further assume that some arc component of $x \cup y - (x \cap y)$ intersects ∂Z in at least 3 points. Then, as in Leininger's argument, a component of $x \cap Z$ is disjoint from a component of $y \cap Z$, so $d_Z^\pi(x, y) \leq 3$. In particular, the condition $d_Z^\pi(x, y) > 3$ forces the intersection numbers $i(x, \partial Z)$ and $i(y, \partial Z)$ to be bounded by twice the number of components of $x \cup y - (x \cap y)$, and there are only finitely many such subsurfaces Z .

For the general case, consider the smallest subsurface Σ' that contains $x \cup y$. Note that if Z is a subsurface and $Z \not\subset \Sigma'$, then there is a curve w in Z disjoint from $x \cap Z$ and from $y \cap Z$, and this implies $d_Z^\pi(x, y) \leq 2$. If $Z \subset \Sigma'$ the proof concludes as in the filling case. \square

Let \mathbf{Y} be a collection of subsurfaces in Σ that pairwise overlap. Since $\{\mathcal{C}(Y)\}_{Y \in \mathbf{Y}}$ satisfies (P0)-(P2), we obtain $\mathcal{C}(\mathbf{Y})$ by Theorem A.

In view of Theorem 4.24, we recall the following theorem [BelF08].

Theorem 5.4. *Every curve graph has finite asymptotic dimension.*

It now yields:

Theorem 5.5. *Let \mathbf{Y} be a collection of subsurfaces that pairwise overlap. Then $\mathcal{C}(\mathbf{Y})$ has finite asymptotic dimension.*

This is because \mathbf{Y} contains only finitely many subsurfaces up to homeomorphism, therefore there is a uniform upper bound on their asymptotic dimension.

We now say a word about the proof of Theorem 5.4 as this is the only place where the dimension bound is not computable. Gromov proved that δ -hyperbolic groups have finite asymptotic dimension. Here is a proof. Assume

that $R \gg \delta$ is an integer. For every vertex v in the Cayley graph of the group at distance $5kR$ from 1, $k = 1, 2, 3, \dots$, consider the set

$$U_v = \{x \in G \mid d(1, x) \in [5(k+1)R, 5(k+2)R] \text{ and } v \text{ lies on some geodesic } [1, x]\}$$

An easy thin triangle argument shows that if v, w are two vertices at distance $5kR$ from 1 such that both U_v and U_w intersect the same R -ball, then $d(v, w) \leq 2\delta$. This gives a bound on the number of U_v 's that can intersect the same R -ball, and this bound is independent of R ; thus $\text{asdim}(G) < \infty$. We can also apply this argument to a tree T to show that $\text{asdim}(T) \leq 1$.

Bell-Fujiwara [BelF08] modified this argument to show that curve complexes have finite asymptotic dimension. They are hyperbolic by the celebrated work of Masur-Minsky [MM99], but not locally finite, resulting in an infinite bound. The trick is to use *tight* geodesics in place of arbitrary geodesics. Finiteness properties of tight geodesics proved by Bowditch [Bow08] imply that asymptotic dimension is finite. Note that Bowditch's finiteness statement is proved via a geometric limit argument with hyperbolic 3-manifolds and does not give a computable bound. It would be interesting to give a new proof of Bowditch's result that gives a computable bound. One could then obtain a computable bound for the asymptotic dimension of the mapping class group.

5.2 Partitioning subsurfaces into finitely many collections

We would like to apply our construction of the projection complex to subsurfaces and their associated curve complexes. To do so we need to partition the set of all subsurfaces into finitely many collections where any two subsurfaces in the same collection overlap.

Lemma 5.6. *There is a coloring $\phi : \mathcal{C}(\Sigma)^{(0)} \rightarrow F$ of the set of simple closed curves on Σ with a finite set F of colors so that if a, b span an edge then $\phi(a) \neq \phi(b)$.*

Proof. Let T be the set of all connected double covers of Σ . If a is a simple closed curve in Σ define a function f_a on the set T as follows. For a double cover $\tilde{\Sigma} \rightarrow \Sigma$ define $f_a(\tilde{\Sigma})$ as 0 if a does not lift to $\tilde{\Sigma}$, and otherwise as the set $\{\alpha, \beta\}$ of homology classes in $H_1(\tilde{\Sigma}; \mathbb{Z}_2)$ determined by the two lifts of a .

The set F of colors is the set of all such functions – it is clearly finite.

We now show that if a, b are disjoint nonparallel simple closed curves, then $f_a \neq f_b$.

We will use the following construction of double covers. Let \mathcal{C} be a non-separating collection of disjoint simple closed curves and properly embedded

arcs in Σ . Then \mathcal{C} determines a double cover $\tilde{\Sigma} \rightarrow \Sigma$ by cutting along \mathcal{C} and gluing cross-wise two copies of the resulting surface (equivalently, the associated index two subgroup is given by curves that intersect \mathcal{C} in an even number of points). In particular for any a we can find a cover $\tilde{\Sigma} \rightarrow \Sigma$ where a lifts by applying the above construction to a non-separating curve or properly embedded arc that is disjoint from a . If a represents a non-trivial homology class and b represents a differently class then $f_a(\tilde{\Sigma}) \neq f_b(\tilde{\Sigma})$. Therefore we can assume that a and b are homologous.

For each component S of $\Sigma \setminus (a \cup b)$ whose boundary is contained in $a \cup b$ choose a simple curve c such that $S \setminus c$ is connected and let \mathcal{C} be the union of such curves. There is at least one and at most three such components so \mathcal{C} contains between one and three curves. Note that the curve c exists since S will have one or two boundary components and can't be a disk or annulus. Therefore S must have positive genus and hence contain a simple curve that doesn't separate S . Let $\tilde{\Sigma}$ be the double cover associated to \mathcal{C} by the construction above. If $f_a(\tilde{\Sigma}) = f_b(\tilde{\Sigma})$ then there will be lifts \tilde{a} and \tilde{b} of a and b that bound a surface $\tilde{S} \subset \tilde{\Sigma}$ such that \tilde{S} doesn't contain either of the other lifts of a and b . Then the restriction of the covering map to \tilde{S} will be a homeomorphism and its image will contain a component of \mathcal{C} . This is a contradiction so we must have $f_a(\tilde{\Sigma}) \neq f_b(\tilde{\Sigma})$. \square

Lemma 5.7 (Color preserving subgroup). *There is a finite index subgroup G of the mapping class group $MCG(\Sigma)$ (where Σ is closed) such that every element of G preserves the colors from the proof of Lemma 5.6.*

We call this subgroup *the color preserving subgroup*.

Proof. The group $Aut(\pi_1(\Sigma))$ lifts to an action (up to homotopy) on the union of connected double covers of Σ . Let G be the subgroup of $Aut(\pi_1(\Sigma))$ that fixes the \mathbb{Z}_2 -homology of this union. This will be a finite index subgroup of $Aut(\pi_1(\Sigma))$ so its image G in $Out(\pi_1\Sigma) \cong MCG(\Sigma)$ will have finite index in $MCG(\Sigma)$ and will fix the colors from Lemma 5.6. \square

Proposition 5.8. *Let Σ be a compact surface with (possibly empty) boundary. Let \mathbf{Y} be the collection of connected incompressible subsurfaces of Σ that are not the sphere with 3 boundary components. Then \mathbf{Y} can be written as a finite disjoint union*

$$\mathbf{Y}^1 \sqcup \mathbf{Y}^2 \sqcup \dots \sqcup \mathbf{Y}^k$$

so that

- the boundaries of any two surfaces in any \mathbf{Y}^i intersect, and
- there is a subgroup $G < MCG(\Sigma)$ of finite index that preserves each \mathbf{Y}^i : if $W \in \mathbf{Y}^i$ and $g \in G$ then $g(W) \in \mathbf{Y}^i$.

Proof. The mapping class group acts on \mathbf{Y} and there are finitely many orbits under the action. Let G be the subgroup given by Lemma 5.7. Since G has finite index in $MCG(\Sigma)$, the action of G on \mathbf{Y} also has finitely many orbits. These orbits are our \mathbf{Y}^i and by definition are invariant under the G -action.

We now show that if $W_0 \neq W_1$ are in \mathbf{Y}^i then they have intersecting boundary. There is a $g \in G$ such that $W_0 = g(W_1)$. Since g preserves the colors if the W_0 and W_1 don't have intersecting boundary then g must fix $\partial W_0 = \partial W_1$ and W_0 must be the complement of W_1 . By assumption the W_i are not spheres with three boundary components. They are also not annuli for if they were then we would have $W_0 = W_1$. In particular W_0 must contain a non-peripheral simple closed curve γ . Since $g(\gamma)$ will be disjoint from γ it will have a different color. As G fixes the colors this is a contradiction. \square

Here is a perhaps unexpected application of our construction. This is an expansion of Theorem F in the introduction.

Theorem 5.9. (i) *Let f be a Dehn twist in the curve γ on Σ . There is a finite index subgroup $G \subset MCG(\Sigma)$ and an action of G on a quasi-tree such that any power f^k of f , $k \neq 0$, that belongs to G is a hyperbolic isometry.*

(ii) *If Σ has even genus g and γ separates into two subsurfaces of genus $g/2$ then we may take $G = MCG(\Sigma)$.*

(iii) *In these actions, there is a bound to the diameter of the projection of a fixed quasi-axis of f^k to any non-parallel translate.*

By contrast, semisimple actions of mapping class groups on $CAT(0)$ spaces always have the property that Dehn twists are elliptic (see [Bri10]). From (i) it follows that a Dehn twist has linear growth in the word length of G , therefore in $MCG(\Sigma)$ (known by [FLM01]).

Proof. If G is the subgroup of Proposition 5.8 or if γ is as in (ii) and $G = MCG(\Sigma)$ then the G -orbit of γ consists of pairwise intersecting curves. Let \mathbf{Y} be this orbit and consider the action of G on the quasi-tree of curve complexes $\mathcal{C}(\mathbf{Y})$. Since each curve complex $\mathcal{C}(g\gamma)$ is quasi-isometric to a line (and they are all isometric to each other), it follows from Theorem 4.14

that $\mathcal{C}(\mathbf{Y})$ is a quasi-tree. Since a nontrivial power of f acts as a hyperbolic isometry on $\mathcal{C}(\gamma)$ the claim follows. The quasi-axis of f^k is the curve complex $\mathcal{C}(\gamma)$ and the non-parallel translates are $\mathcal{C}(g\gamma)$ where g doesn't fix γ . Since the projection of $\mathcal{C}(g\gamma)$ to $\mathcal{C}(\gamma)$ has diameter 1, the last statement is a consequence of Theorem A. \square

Here is another related application to the Rips complex, $P_d(\mathcal{G})$, of a graph \mathcal{G} . Rips has shown that if \mathcal{G} is δ -hyperbolic then for d sufficiently large, $P_d(\mathcal{G})$ is contractible [Gro87]. It has been hoped that with the same assumptions, for d sufficiently large $P_d(\mathcal{G})$ is $CAT(0)$. The quasi-tree given by (ii) gives a counter-example to this conjecture, at least for infinite valence graphs.

Corollary 5.10. *There exist infinite diameter, infinite valence graphs that are quasi-isometric to trees but whose Rips complex is never $CAT(0)$.*

Proof. Let \mathcal{G} be the quasi-tree given by (ii) of Theorem 5.9. Then $MCG(\Sigma)$ acts on \mathcal{G} with the Dehn twist about the curve γ acting hyperbolically. Then $MCG(\Sigma)$ will act on $P_d(\mathcal{G})$ for all d and the Dehn twist will still act hyperbolically. Moreover, since the action on \mathcal{G} is always semi-simple, [Man06], so is the action on $P_d(\mathcal{G})$. Therefore, by Bridson's theorem [Bri10], $P_d(\mathcal{G})$ is not $CAT(0)$. \square

5.3 Embedding MCG into a finite product of $\mathcal{C}(\mathbf{Y})$'s

Fix a set of finite generators for $MCG(\Sigma)$ and for all $g \in MCG(\Sigma)$ let $|g|$ be the word length norm. We need the following proposition. Recall that a finite collection of simple closed curves is *binding* if every nonperipheral curve intersects at least one curve in α . If W is any subsurface and $g \in MCG(\Sigma)$, the restrictions $\pi_W(\alpha)$ and $\pi_W(g(\alpha))$ are nonempty and we denote by $d_W^\pi(\alpha, g(\alpha))$ the diameter of their union in the curve complex of W .

Proposition 5.11. *Let α be a finite binding collection of simple closed curves on Σ . Given any $B > 0$ there exists a $C > 0$ such that if $|g| > C$ then there is a subsurface W such that $d_W^\pi(\alpha, g(\alpha)) > B$.*

Proof. Fix a hyperbolic metric on Σ . When we discuss the Hausdorff limit of a sequence of curves we assume that they have been realized by hyperbolic geodesics in this metric.

Assume that the lemma is false. Then there exists a sequence of g_i such that $|g_i| \rightarrow \infty$ but $d_W^\pi(\alpha, g_i(\alpha)) \leq B$ for all subsurfaces W . We pass

to a subsequence (which we don't relabel) such that $g_i(c)$ has a Hausdorff limit for each curve c in α (see e.g. [CB88] for basic facts about Hausdorff convergence in the lamination space). There are then three possibilities:

- If the Hausdorff limits are all simple closed curves then the sequences $g_i(c)$ must become constant. However there are only finitely many elements of $MCG(\Sigma)$ that have the same image on a set of binding curves. This contradicts $|g_i| \rightarrow \infty$.
- Fix a c in α and let λ be the Hausdorff limit of $g_i(c)$. Also assume that there is a minimal component λ_Y of λ that fills a non-annular subsurface Y . Let c' be a curve in α that intersects Y . We will modify an argument of F. Luo (see [MM99, Section 4.3]) to show that $d_Y^\pi(g_i(c), c') \rightarrow \infty$. If $d_{\mathcal{C}(Y)}(\pi_Y(c'), \pi_Y(g_i(c)))$ is bounded we can pass to a subsequence where the distance is constant. For each i let $x_i \in \mathcal{C}(Y)$ be adjacent to $\pi_Y(g_i(c))$ but closer to $\pi_Y(c')$. We can pass to another subsequence such that x_i converges in the Hausdorff topology to a lamination λ' . As the x_i and $\pi_Y(g_i(c))$ are disjoint λ' and λ_Y can't intersect and since λ_Y fills Y this implies that $\lambda' = \lambda_Y$, perhaps with some isolated leaves added. We can repeat this until we have a sequence in $\mathcal{C}(Y)$ disjoint from $\pi_Y(c')$ that converges to the filling lamination λ_Y (plus isolated leaves). This is a contradiction so we must have $d_Y(g_i(c), c') \rightarrow \infty$.
- The final case is when the Hausdorff limit λ isn't a collection of simple curves but doesn't have a component that fills a non-annular subsurface. In this case there must be a leaf of λ that spirals around a simple closed curve β . Let c' be a curve in α that intersects β . Again fix a hyperbolic metric on Σ . We also fix an annular neighborhood X of β . Then $d_X^\pi(g_i(c), c') = i_X(g_i(c), c')$. Since λ spirals around β we have $i_X(g_i(c), c') \rightarrow \infty$ and therefore $d_X^\pi(g_i(c), c') \rightarrow \infty$.

□

Let G be the subgroup of $MCG(\Sigma)$ from Proposition 5.8 and let

$$\mathbf{Y}^1, \dots, \mathbf{Y}^k$$

be the orbits of subsurfaces under G . Note that by construction one of the collections consists of the single surface Σ . Let

$$\Pi = \mathcal{C}(\mathbf{Y}^1) \times \mathcal{C}(\mathbf{Y}^2) \times \dots \times \mathcal{C}(\mathbf{Y}^k)$$

be the product of quasi-trees of curve complexes. Then $MCG(\Sigma)$ acts on Π . For elements in G the coordinates are fixed while other elements will permute them.

Define $\Psi : MCG(\Sigma) \rightarrow \Pi$ by choosing a base vertex as the image of 1 and extending the map equivariantly. Note that one of the factors in the target is just the curve complex $\mathcal{C}(\Sigma)$. We put the l_1 -metric on the product space Π . By construction Ψ is Lipschitz.

Proposition 5.12. *Ψ is a coarse embedding.*

Proof. We will show that the restriction of Ψ to G is a coarse embedding. This will imply the proposition since G has finite index in MCG . Note that if Ψ is a coarse embedding or not does not depend on the choice of the base point.

Say the basepoint has $\mathcal{C}(\mathbf{Y}^i)$ -coordinate equal to a curve γ_i in a surface W_i , and in the special factor $\mathcal{C}(\Sigma)$ the coordinate is a curve γ . We may choose the binding set α to contain γ , the γ_i and the boundary components of the W_i 's.

Note that for all subsurfaces W the diameter of $\pi_W(\alpha)$ in $\mathcal{C}(W)$ is bounded by a fixed constant $D > 0$. For example we could choose D to be one plus the number of intersection points.

Fix some $B > 0$ and let C be the constant given by Proposition 5.11 with respect to α and $B + 2D$. We'll show that if $|g| > C$ then $d_\Pi(\Psi(id), \Psi(g)) > B$ which implies that Ψ is a coarse embedding.

By Proposition 5.11 there exists a subsurface W such that $d_W^\pi(\alpha, g(\alpha)) > C$. The subsurface W is in one of the collections \mathbf{Y}^i . Since $\pi_W(\gamma_i)$ and $\pi_W(g(\gamma_i))$ are contained in $\pi_W(\alpha)$ and $\pi_W(g(\alpha))$ and the latter have diameter bounded by D we have $d_W^\pi(\gamma_i, g(\gamma_i)) \geq d(\alpha, g(\alpha)) - 2D$. By Proposition 4.2 we then have

$$\begin{aligned} d_\Pi(\Psi(id), \Psi(g)) &\geq d_{\mathcal{C}(\mathbf{Y}^i)}(\gamma_i, g(\gamma_i)) \\ &\geq d_W^\pi(\gamma_i, g(\gamma_i)) \\ &\geq \pi_W(\alpha, g(\alpha)) - 2D \\ &\geq B \end{aligned}$$

and the proposition is proved. \square

It is also true that Ψ is a quasi-isometric embedding. We will not need this stronger result to prove Theorem D, but we include the proof since it may be of independent interest.

Theorem C. $MCG(\Sigma)$ equivariantly quasi-isometrically embeds in a finite product of hyperbolic spaces.

Proof. The proof uses the remarkable Masur-Minsky formula [MM00], which asserts that

$$|g| \simeq \sum_W \{\{d_W(\alpha, g(\alpha))\}\}_M$$

where $g \in MCG(\Sigma)$, $|g|$ is the word-norm of g with respect to any fixed finite generating set for $MCG(\Sigma)$, \simeq is *coarse equivalence*, i.e. each side is bounded by a linear function of the other, $\{\{x\}\}_M = x$ if $x > M$ and otherwise it is 0, the sum is taken over all subsurfaces of Σ , α is a fixed finite binding set of curves in Σ , and $d_W(\alpha, g(\alpha))$ is the distance in the curve complex of W between the projections of a curve in α and a curve in $g(\alpha)$ (we must choose a curve that has a projection; choosing a different such curve changes the distance by a bounded amount), and M is a sufficiently large constant. By enlarging M or K' from Theorem 4.13 we may assume that $M = K'$. The two estimates combine to give that $|g| \leq Ad(\Psi(1), \Psi(g)) + B$ for universal constants A, B . The reverse bound follows from the fact that Ψ is Lipschitz. \square

Theorem D. Let Σ be a compact orientable surface with (possibly empty) boundary. Then $\text{asdim}(MCG(\Sigma)) < \infty$.

Proof. If $\chi(\Sigma) > 0$ then $MCG(\Sigma)$ is finite and $\text{asdim}(MCG(\Sigma)) = 0$. If the Σ is a torus, $MCG(\Sigma)$ is virtually free and hence $\text{asdim}(MCG(\Sigma)) = 1$. Assume $\chi(\Sigma) < 0$. By the Product Formula and Theorem 4.24 it follows that $\text{asdim}(\Pi) < \infty$. Note that the Product formula applies to the ℓ_1 -product. Proposition 5.12 then implies that $\text{asdim}(MCG(\Sigma)) < \infty$. \square

Let Σ be a possibly punctured closed surface and $\mathcal{T}(\Sigma)$ its Teichmüller space equipped with the Teichmüller metric.

Theorem 5.13. $\text{asdim}(MCG(\Sigma)) \leq \text{asdim}(\mathcal{T}(\Sigma)) < \infty$.

Since $MCG(\Sigma)$ acts on $\mathcal{T}(\Sigma)$ properly discontinuously, an orbit map $MCG(\Sigma) \rightarrow \mathcal{T}(\Sigma)$ is a coarse embedding. Thus we have $\text{asdim}(MCG(\Sigma)) \leq \text{asdim}(\mathcal{T}(\Sigma))$. The proof of the second inequality will use the following facts. When γ is a curve in Σ and $\epsilon > 0$ denote by $Thin_\epsilon(\Sigma, \gamma)$ the subset of $\mathcal{T}(\Sigma)$ where γ has hyperbolic length $< \epsilon$.

- (A) **Minsky's Product Theorem.** [Min96a] If ϵ is small enough, the subspace $Thin_\epsilon(\Sigma, \gamma)$ is quasi-isometric to the product $\mathcal{T}(\Sigma/\gamma) \times Z$ where Z is a horoball in hyperbolic plane and Σ/γ denotes the surface obtained from Σ by cutting open along γ and crushing the boundary components to punctures (if γ is separating this Teichmüller space is the product of Teichmüller spaces of the components).
- (B) For every $R > 0$ there is $\epsilon_0 > 0$ such that whenever γ and γ' intersect then $Thin_{\epsilon_0}(\Sigma, \gamma)$ and $Thin_{\epsilon_0}(\Sigma, \gamma')$ are R -separated.

Statement (B) follows easily from Kerckhoff's Theorem [Ker80], or indeed from (A).

Proof of Theorem 5.13. The proof is by induction on the complexity of the surface, which is the dimension of $\mathcal{T}(\Sigma)$. Induction starts with the case of 2-dimensional Teichmüller space (hyperbolic plane) when asymptotic dimension is 2.

For the inductive step, note that (A) and the Product Formula for asymptotic dimension immediately imply that thin parts have finite asymptotic dimension. Write the collection of all curves on Σ as a finite disjoint union $C_1 \sqcup C_2 \sqcup \cdots \sqcup C_k$ so that curves in the same collection intersect. It was shown that this is possible for closed Σ in Lemma 5.6, but the punctured case follows quickly from the closed case (e.g. blow up the punctures to boundary components and double).

Consider the subsets

$$Thick = X_0 \subset X_1 \subset X_2 \subset \cdots \subset X_k = \mathcal{T}(\Sigma)$$

where X_i is the subset of $\mathcal{T}(\Sigma)$ consisting of hyperbolic surfaces with the property that if γ is a curve with length $< \epsilon$ then $\gamma \in C_1 \cup \cdots \cup C_i$, and Thick consists of hyperbolic surfaces with no essential curves of length $< \epsilon$. Let N be chosen so that $\text{asdim}(MCG(\Sigma)) \leq N$ and so that $\text{asdim}(Thin_\epsilon(\Sigma, \gamma)) \leq N$ for every curve γ . We will argue by induction on i that $\text{asdim}(X_i) \leq N$.

When $i = 0$ this follows from the fact that X_0 (the thick part) is quasi-isometric to $MCG(\Sigma)$. Suppose $\text{asdim}(X_i) \leq N$.

Now write

$$X_{i+1} = X_i \cup \bigcup_{\gamma \in C_{i+1}} Y_\gamma^i$$

where Y_γ^i is the set of hyperbolic structures in $Thin_\epsilon(\Sigma, \gamma)$ where every curve shorter than ϵ is either equal to γ or belongs to $C_1 \cup \cdots \cup C_i$. We will check the conditions of the Union Theorem.

Let $R > 0$ be given, let ϵ_0 be as in (B) (we may assume that $\epsilon_0 < \epsilon$). Define

$$Y_R = X_i \cup \bigcup_{\gamma \in C_{i+1}} Z_\gamma^i$$

where Z_γ^i is the set of hyperbolic structures where γ has length in the interval $[\epsilon_0, \epsilon)$ and any curve of length $< \epsilon$ is either γ or belongs to $C_1 \cup \dots \cup C_i$. By (B) the sets $Y_\gamma^i \setminus Y_R$ are R -separated and each set is contained in $Thin_\epsilon(\Sigma, \gamma)$ and the latter sets have $\text{asdim} \leq N$ uniformly, since there are only finitely many isometry types of such sets. Therefore we only need to argue that $\text{asdim}(Y_R) \leq N$. But Y_R is contained in a Hausdorff neighborhood of X_i , as follows easily from Minsky's Product Theorem. That $\text{asdim}(X_i) \leq N$ is the inductive hypothesis. \square

A variation of the argument also shows that Teichmüller space equipped with Weil-Petersson metric has finite asymptotic dimension. Denote this space by $\mathcal{T}_{WP}(\Sigma)$. Let $\mathcal{P}(\Sigma)$ be the *pants complex* for Σ , where a vertex is represented by a pants decomposition of Σ and an edge corresponds to a pair of pants decompositions that differ in only one curve in each, and the two curves intersect minimally (one or two points, depending on whether their removal produces a complementary component which is a punctured torus or a 4-punctured sphere). There is a natural coarse map $\Upsilon : \mathcal{P}(\Sigma) \rightarrow \mathcal{T}_{WP}(\Sigma)$ that sends a pants decomposition to the (bounded) set consisting of hyperbolic metrics where the curves in the decomposition have length bounded by a Bers constant. Brock [Bro03, Bro02] proved that Υ is an equivariant quasi-isometry.

Theorem 5.14. $\text{asdim}(\mathcal{T}_{WP}(\Sigma)) = \text{asdim}(\mathcal{P}(\Sigma)) < \infty$.

Proof. Consider an orbit map $MCG(\Sigma) \rightarrow \mathcal{P}(\Sigma)$ and define a (pseudo) metric on $MCG(\Sigma)$ by restricting the one from $\mathcal{P}(\Sigma)$ (some pairs of points may have distance 0). Since the action of $MCG(\Sigma)$ on the pants complex has finitely many orbits of simplices, $MCG(\Sigma)$ with this metric, d , is quasi-isometric to the pants complex. There is a Masur-Minsky estimate for the distance between 1 and $g \in MCG(\Sigma)$ (see the discussion in [MM00, Section 8]):

$$d(1, g) \simeq \sum_W \{ \{d_W(\alpha, g(\alpha))\} \}_M$$

where W runs over subsurfaces which are *not* annuli. We have an action of $MCG(\Sigma)$ on

$$\Pi = \mathcal{C}(\mathbf{Y}^1) \times \mathcal{C}(\mathbf{Y}^2) \times \dots \times \mathcal{C}(\mathbf{Y}^k)$$

as before, where we delete all annuli from the \mathbf{Y}^i 's. The orbit map is a quasi-isometric embedding (with respect to the new metric on $MCG(\Sigma)$) by exactly the same argument as before. The theorem follows. \square

References

- [AK11] Yael Algom-Kfir. Strongly contracting geodesics in Outer space. *Geometry and Topology*, 15(4):2181–2234, 2011.
- [AKB12] Yael Algom-Kfir and Mladen Bestvina. Asymmetry of outer space. *Geom. Dedicata*, 156:81–92, 2012.
- [BaBr] Werner Ballmann and Michael Brin. Orbihedra of nonpositive curvature. *Inst. Hautes Études Sci. Publ. Math.*, (82):169–209 (1996), 1995.
- [Beh06] Jason A. Behrstock. Asymptotic geometry of the mapping class group and Teichmüller space. *Geom. Topol.*, 10:1523–1578, 2006.
- [BC12] Jason Behrstock and Ruth Charney. Divergence and quasimorphisms of right-angled Artin groups. *Math. Ann.*, 352(2):339–356, 2012.
- [BDS11a] Jason Behrstock, Cornelia Druţu, and Mark Sapir. Addendum: Median structures on asymptotic cones and homomorphisms into mapping class groups [mr2783135]. *Proc. Lond. Math. Soc. (3)*, 102(3):555–562, 2011.
- [BDS11b] Jason Behrstock, Cornelia Druţu, and Mark Sapir. Median structures on asymptotic cones and homomorphisms into mapping class groups. *Proc. Lond. Math. Soc. (3)*, 102(3):503–554, 2011.
- [BM08] Jason A. Behrstock and Yair N. Minsky. Dimension and rank for mapping class groups. *Ann. of Math. (2)*, 167(3):1055–1077, 2008.
- [BD06] G. C. Bell and A. N. Dranishnikov. A Hurewicz-type theorem for asymptotic dimension and applications to geometric group theory. *Trans. Amer. Math. Soc.*, 358(11):4749–4764 (electronic), 2006.
- [BD08] G. Bell and A. Dranishnikov. Asymptotic dimension. *Topology Appl.*, 155(12):1265–1296, 2008.

- [BelF08] Gregory C. Bell and Koji Fujiwara. The asymptotic dimension of a curve graph is finite. *J. Lond. Math. Soc. (2)*, 77(1):33–50, 2008.
- [Bes11] Mladen Bestvina. A Bers-like proof of the existence of train tracks for free group automorphisms. *Fund. Math.*, 214(1):1–12, 2011.
- [BB] Mladen Bestvina and Kenneth Bromberg. On the asymptotic dimension of a curve complex. preprint, 2014.
- [BBFa] Mladen Bestvina, Kenneth Bromberg, and Koji Fujiwara. Bounded cohomology with coefficients in uniformly convex Banach spaces. <http://arxiv.org/abs/1306.1542>.
- [BBFb] Mladen Bestvina, Kenneth Bromberg, and Koji Fujiwara. Projection complexes, acylindrically hyperbolic groups and bounded cohomology. preprint, 2014.
- [BBFc] Mladen Bestvina, Kenneth Bromberg, and Koji Fujiwara. Stable commutator length on mapping class groups. <http://arxiv.org/abs/1306.2394>.
- [BFe14a] Mladen Bestvina and Mark Feighn. Hyperbolicity of the complex of free factors. *Advances in Mathematics*, 256(0):104 – 155, 2014.
- [BFe14b] Mladen Bestvina and Mark Feighn. Subfactor projections. *Journal of Topology*, 2014. 34 pages.
- [BF02] Mladen Bestvina and Koji Fujiwara. Bounded cohomology of subgroups of mapping class groups. *Geom. Topol.*, 6:69–89 (electronic), 2002.
- [BF09] Mladen Bestvina and Koji Fujiwara. A characterization of higher rank symmetric spaces via bounded cohomology. *Geom. Funct. Anal.*, 19(1):11–40, 2009.
- [Bow08] Brian H. Bowditch. Tight geodesics in the curve complex. *Invent. Math.*, 171(2):281–300, 2008.
- [Bri10] Martin R. Bridson. Semisimple actions of mapping class groups on CAT(0) spaces. In *Geometry of Riemann surfaces*, volume 368 of *London Math. Soc. Lecture Note Ser.*, pages 1–14. Cambridge Univ. Press, Cambridge, 2010.

- [BV06] Martin R. Bridson and Karen Vogtmann. Automorphism groups of free groups, surface groups and free abelian groups. In *Problems on mapping class groups and related topics*, volume 74 of *Proc. Sympos. Pure Math.*, pages 301–316. Amer. Math. Soc., Providence, RI, 2006.
- [Bro02] Jeffrey F. Brock. Pants decompositions and the Weil-Petersson metric. In *Complex manifolds and hyperbolic geometry (Guanaquato, 2001)*, volume 311 of *Contemp. Math.*, pages 27–40. Amer. Math. Soc., Providence, RI, 2002.
- [Bro03] Jeffrey F. Brock. The Weil-Petersson metric and volumes of 3-dimensional hyperbolic convex cores. *J. Amer. Math. Soc.*, 16(3):495–535 (electronic), 2003.
- [BuM00] Marc Burger and Shahar Mozes. Lattices in product of trees. *Inst. Hautes Études Sci. Publ. Math.*, (92):151–194 (2001), 2000.
- [CF10] Pierre-Emmanuel Caprace and Koji Fujiwara. Rank-one isometries of buildings and quasi-morphisms of Kac-Moody groups. *Geom. Funct. Anal.*, 19(5):1296–1319, 2010.
- [CS11] Pierre-Emmanuel Caprace and Michah Sageev. Rank rigidity for CAT(0) cube complexes. *Geom. Funct. Anal.*, 21(4):851–891, 2011.
- [CB88] Andrew J. Casson and Steven A. Bleiler. *Automorphisms of surfaces after Nielsen and Thurston*, volume 9 of *London Mathematical Society Student Texts*. Cambridge University Press, Cambridge, 1988.
- [CV86] Marc Culler and Karen Vogtmann. Moduli of graphs and automorphisms of free groups. *Invent. Math.*, 84(1):91–119, 1986.
- [DGO] F. Dahmani, V. Guirardel, and D. Osin. Hyperbolically embedded subgroups and rotating families in groups acting on hyperbolic spaces. arXiv:1111.7048.
- [dlHV89] Pierre de la Harpe and Alain Valette. La propriété (T) de Kazhdan pour les groupes localement compacts (avec un appendice de Marc Burger). *Astérisque*, (175):158, 1989. With an appendix by M. Burger.

- [Del] Thomas Delzant. A finiteness property on monodromies of holomorphic families. arXiv:1402.4384.
- [DrS] Cornelia Druţu, Mark Sapir. Tree-graded spaces and asymptotic cones of groups. *Topology*, 44(5):959–1058, 2005. With an appendix by Denis Osin and Sapir.
- [EF97] David B. A. Epstein and Koji Fujiwara. The second bounded cohomology of word-hyperbolic groups. *Topology*, 36(6):1275–1289, 1997.
- [EMR] Alex Eskin, Howard Masur, and Kasra Rafi. Large scale rank of Teichmüller space. arXiv:1307.3733.
- [FLM01] Benson Farb, Alexander Lubotzky, and Yair Minsky. Rank-1 phenomena for mapping class groups. *Duke Math. J.*, 106(3):581–597, 2001.
- [FM12] Benson Farb and Dan Margalit. *A primer on mapping class groups*, volume 49 of *Princeton Mathematical Series*. Princeton University Press, Princeton, NJ, 2012.
- [FPS] R. Frigerio, M. B. Pozzetti, and A. Sisto. Extending higher dimensional quasi-cocycles. arXiv:1311.7633.
- [Gro87] M. Gromov. Hyperbolic groups. In *Essays in group theory*, volume 8 of *Math. Sci. Res. Inst. Publ.*, pages 75–263. Springer, New York, 1987.
- [Gro93] M. Gromov. Asymptotic invariants of infinite groups. In *Geometric group theory, Vol. 2 (Sussex, 1991)*, volume 182 of *London Math. Soc. Lecture Note Ser.*, pages 1–295. Cambridge Univ. Press, Cambridge, 1993.
- [Ham09] Ursula Hamenstädt. Geometry of the mapping class groups. I. Boundary amenability. *Invent. Math.*, 175(3):545–609, 2009.
- [HM13] Michael Handel and Lee Mosher. The free splitting complex of a free group, I: hyperbolicity. *Geom. Topol.*, 17(3):1581–1672, 2013.
- [Hum] David Hume. Embedding mapping class groups into finite products of trees. arXiv:1207.2132.
- [Ker80] Steven P. Kerckhoff. The asymptotic geometry of Teichmüller space. *Topology*, 19(1):23–41, 1980.

- [Kid08] Yoshikata Kida. The mapping class group from the viewpoint of measure equivalence theory. *Mem. Amer. Math. Soc.*, 196(916):viii+190, 2008.
- [MS13] John M. Mackay and Alessandro Sisto. Embedding relatively hyperbolic groups in products of trees. *Algebr. Geom. Topol.*, 13(4):2261–2282, 2013.
- [Man05] Jason Fox Manning. Geometry of pseudocharacters. *Geom. Topol.*, 9:1147–1185 (electronic), 2005.
- [Man06] J. F. Manning. Quasi-actions on trees and property (QFA). *J. London Math. Soc. (2)*, 73(1):84–108, 2006. With an appendix by N. Monod and B. Rémy.
- [Mang10] Johanna Mangahas. Uniform uniform exponential growth of subgroups of the mapping class group. *Geom. Funct. Anal.*, 19(5):1468–1480, 2010.
- [Mang13] Johanna Mangahas. A recipe for short-word pseudo-Anosovs. *Amer. J. Math.*, 135(4):1087–1116, 2013.
- [MP12] Álvaro Martínez-Pérez. Bushy pseudocharacters and group actions on quasitrees. *Algebr. Geom. Topol.*, 12(3):1725–1743, 2012.
- [MM99] Howard A. Masur and Yair N. Minsky. Geometry of the complex of curves. I. Hyperbolicity. *Invent. Math.*, 138(1):103–149, 1999.
- [MM00] H. A. Masur and Y. N. Minsky. Geometry of the complex of curves. II. Hierarchical structure. *Geom. Funct. Anal.*, 10(4):902–974, 2000.
- [Min96a] Yair N. Minsky. Extremal length estimates and product regions in Teichmüller space. *Duke Math. J.*, 83(2):249–286, 1996.
- [Min96b] Yair N. Minsky. Quasi-projections in Teichmüller space. *J. Reine Angew. Math.*, 473:121–136, 1996.
- [Mon06] Nicolas Monod. An invitation to bounded cohomology. In *International Congress of Mathematicians. Vol. II*, pages 1183–1211. Eur. Math. Soc., Zürich, 2006.
- [MSW03] Lee Mosher, Michah Sageev, and Kevin Whyte. Quasi-actions on trees. I. Bounded valence. *Ann. of Math. (2)*, 158(1):115–164, 2003.

- [Osi] D. Osin. Acylindrically hyperbolic groups. arXiv:1304.1246.
- [Roe03] John Roe. *Lectures on coarse geometry*, volume 31 of *University Lecture Series*. American Mathematical Society, Providence, RI, 2003.
- [Sis] Alessandro Sisto. On metric relative hyperbolicity. arXiv:1210.8081.
- [Vog02] Karen Vogtmann. Automorphisms of free groups and outer space. In *Proceedings of the Conference on Geometric and Combinatorial Group Theory, Part I (Haifa, 2000)*, volume 94, pages 1–31, 2002.
- [Vog06] Karen Vogtmann. The cohomology of automorphism groups of free groups. In *International Congress of Mathematicians. Vol. II*, pages 1101–1117. Eur. Math. Soc., Zürich, 2006.
- [Web] Richard C.H. Webb. Combinatorics of tight geodesics and stable lengths. arXiv:1305.3566.
- [Yu98] Guoliang Yu. The Novikov conjecture for groups with finite asymptotic dimension. *Ann. of Math. (2)*, 147(2):325–355, 1998.