

DISTRIBUTION OF THE LINEAR FLOW LENGTH IN A HONEYCOMB IN THE SMALL-SCATTERER LIMIT

FLORIN P. BOCA

ABSTRACT. We study the statistics of the linear flow in a punctured honeycomb lattice, or equivalently the free motion of a particle on a regular hexagonal billiard table with holes of equal size at the corners and obeying the customary reflection rules. In the small-scatterer limit we prove the existence of the limiting distribution of the free path length with randomly chosen origin of the trajectory and explicitly compute it.

1. INTRODUCTION

From the regular hexagon of unit size remove circular holes of small radius $\varepsilon > 0$ centered at the vertices, obtaining the billiard table H_ε of area $|H_\varepsilon| = \frac{3\sqrt{3}}{2} - 2\pi\varepsilon^2$. For each pair $(\mathbf{x}, \omega) \in H_\varepsilon \times [0, 2\pi]$ consider a point particle moving at unit speed on a linear trajectory, with specular reflections when reaching the boundary. The time $\tau_\varepsilon^{\text{hex}}(\mathbf{x}, \omega)$ it takes the particle to reach one of the holes is called the *free path length* (or *first exit time*). Equivalently, one can consider the unit honeycomb tessellation of the euclidean plane, with “fat points” (obstacles or scatterers) of radius ε centered at the vertices $m\mathbf{e}_1 + n\mathbf{j}$, $m \not\equiv n \pmod{3}$, of the lattice $\Lambda_\varepsilon = \mathbb{Z}\mathbf{e}_1 + \mathbb{Z}\mathbf{j} = \mathbb{Z}^2 \begin{pmatrix} 1 & 0 \\ 1/2 & \sqrt{3}/2 \end{pmatrix}$, $\mathbf{j} = (\frac{1}{2}, \frac{\sqrt{3}}{2})$, and a particle moving at unit speed and velocity ω on a linear trajectory until it hits one of the obstacles (see Figure 1). If the initial position \mathbf{x} is always chosen in a fundamental domain, the first hitting time coincides with $\tau_\varepsilon^{\text{hex}}(\mathbf{x}, \omega)$. In this paper we are interested in estimating the probability

$$\mathbb{P}_\varepsilon^{\text{hex}}(\xi) = \frac{1}{2\pi|H_\varepsilon|} \left| \{(\mathbf{x}, \omega) \in H_\varepsilon \times [0, 2\pi] : \varepsilon\tau_\varepsilon^{\text{hex}}(\mathbf{x}, \omega) > \xi\} \right|, \quad \xi \in [0, \infty), \quad (1.1)$$

that $\varepsilon\tau_\varepsilon^{\text{hex}}(\mathbf{x}, \omega) > \xi$ as $\varepsilon \rightarrow 0^+$. We will prove that $\Phi^{\text{hex}}(\xi) = \lim_{\varepsilon \rightarrow 0^+} \mathbb{P}_\varepsilon^{\text{hex}}(\xi)$ exists for all $\xi \geq 0$ and show how to explicitly compute $\Phi^{\text{hex}}(\xi)$.

The version of this problem where the initial point is chosen to be the center of the hexagon has been solved in [3]. The square lattice analog of estimating (1.1) has a longer history originating in the work of H. A. Lorentz [14] and G. Pólya [19]. A complete solution was given in [7]. A detailed history and presentation of various ideas and tools involved in this and related problems, as well as a description of recent developments in the study of the periodic Lorentz gas, including [10, 11, 12, 16, 17, 18], is provided in [13, 15].

One additional difficulty encountered here is the absence of a theory of continued fractions in the case of the hexagonal tessellation. To bypass this obstacle we shall deform this tessellation, as in [3], into $\mathbb{Z}_{(3)}^2 = \{(m, n) \in \mathbb{Z}^2, m \not\equiv n \pmod{3}\}$. The three-strip partition of the unit square employed [9, 7] in the situation of the square lattice, or equivalently the corresponding tiling of \mathbb{R}^2 shown in Figure 6, will be useful here. However, the presence of certain $(\text{mod } 3)$ constraints translates here

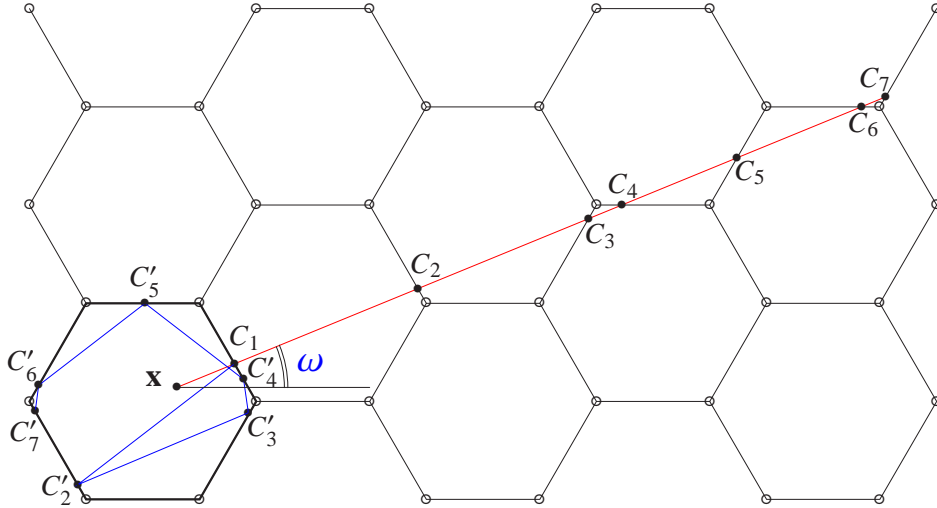

FIGURE 1. The free path in a hexagonal billiard and respectively in a hexagonal lattice

in the existence of a positive proportion of angles with very long trajectories. This leads to a large number of (non-redundant) cases that have to be analyzed individually. The main result is

Theorem 1. *There exists a decreasing continuous function $\Phi^{\text{hex}} : [0, \infty) \rightarrow (0, \infty)$, $\Phi^{\text{hex}}(0) = 1$, $\Phi^{\text{hex}}(\infty) = 0$, such that for any $\delta > 0$, as $\varepsilon \rightarrow 0^+$,*

$$\mathbb{P}_\varepsilon^{\text{hex}}(\xi) = \Phi^{\text{hex}}(\xi) + O_\delta(\varepsilon^{\frac{1}{8}-\delta}), \quad \forall \xi \geq 0,$$

uniformly for ξ in compact subsets of $[0, \infty)$. Moreover, there exist constants $C_1, C_2 > 0$ such that

$$\frac{C_1}{\xi} \leq \Phi^{\text{hex}}(\xi) \leq \frac{C_2}{\xi}, \quad \forall \xi \in [1, \infty). \quad (1.2)$$

Estimate (1.2) is discussed in Remark 2 of Section 5. The repartition function Φ^{hex} can be explicitly computed as

$$\Phi^{\text{hex}}(\xi) = \frac{4}{\pi^2} G\left(\frac{2\xi}{\sqrt{3}}\right), \quad (1.3)$$

with $G(\xi)$ obtained by adding all terms $\frac{\zeta(2)}{c_l} G_{l,Q}^{(*)}$ from formulas (5.22), (6.6), (6.7), (6.8), (6.9), (6.10), (6.11), (7.1), (7.2), (7.5), (7.6), (7.8), (7.11), (7.12), (7.13), (8.1), (8.2), (8.5), (8.6), (8.8), (8.9), (8.10), (8.11), (8.12), (8.13), (8.14), (9.1), (9.2), (9.4), (9.5), (9.6), (9.7), (9.9), (9.10), (9.11), (9.12), (9.13), (9.14), (9.15) and (9.16).

In the case of the square lattice only the term from (5.22) arises, with a different constant and no $\frac{2}{\sqrt{3}}$ scaling for ξ . The limiting distribution Φ^\square also satisfies (1.2).

In the case of a lattice it was actually proved in [16] that for every $\mathbf{x} \in \mathbb{R}^2 \setminus \mathbb{Q}^2$, $\lim_{\varepsilon \rightarrow 0^+} \frac{1}{2\pi} \left| \left\{ \omega \in [0, 2\pi) : \varepsilon \tau_\varepsilon^\square(\mathbf{x}, \omega) > \xi \right\} \right| = \Phi^\square(\xi)$. It would be interesting to know whether a similar result holds true for a generic choice of \mathbf{x} in the case of the honeycomb.

The analog problem about the free path length in a regular polygon with n sides ($n \neq 3, 4, 6$) seems to be out of reach at this time, due to lack of a tractable coding for the linear flow. In the case of the regular octagon the recent results in [20] may prove helpful.

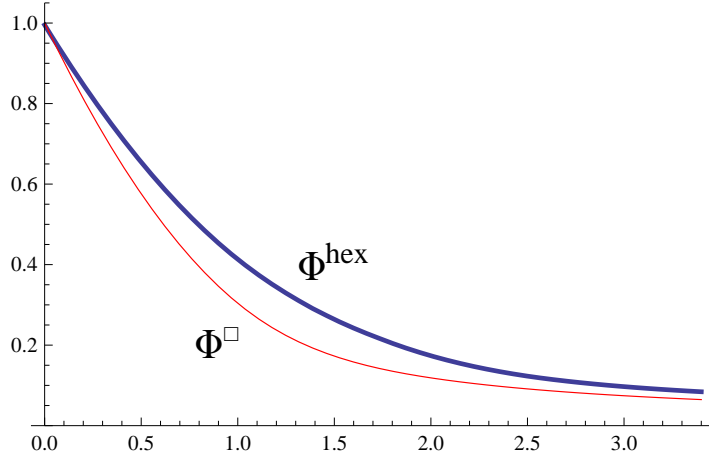
FIGURE 2. The limiting repartition functions Φ^{hex} and Φ^{\square}

2. TRANSLATING THE PROBLEM TO THE SQUARE LATTICE WITH mod 3 CONSTRAINTS

For manifest symmetry reasons it suffices to consider $\mathbf{x} \in H_\varepsilon$ and $\omega \in [0, \frac{\pi}{6}]$, or equivalently $t = \tan \omega \in [0, \frac{1}{\sqrt{3}}]$. We will simply write $\tau_\varepsilon^{\text{hex}}(\mathbf{x}, \omega) = \tau_\varepsilon^{\text{hex}}(\mathbf{x}, t)$. As in [3] consider the lattice $\mathbb{Z}^2 M_0$, $M_0 = \begin{pmatrix} 1 & 0 \\ 1/2 & \sqrt{3}/2 \end{pmatrix}$, and the linear transformation $T\mathbf{x} = \mathbf{x}M_0^{-1}$ on \mathbb{R}^2 :

$$T(x, y) = \left(x - \frac{y}{\sqrt{3}}, \frac{2y}{\sqrt{3}} \right) = (x', y').$$

This maps the vertices $(q + \frac{a}{2}, \frac{a\sqrt{3}}{2})$ of the grid of equilateral triangles of unit side onto the vertices (q, a) of the square lattice \mathbb{Z}^2 . The vertices of the honeycomb are mapped exactly into $\mathbb{Z}_{(3)}^2$, the subset of elements of \mathbb{Z}^2 with $q \not\equiv a \pmod{3}$ (see Figure 3). The points of the x -axis are fixed by T . The circular scatterers $S_{q,a,\varepsilon} = (x_0, y_0) + \varepsilon(\cos \theta, \sin \theta)$ with $(x_0, y_0) = (q + \frac{a}{2}, \frac{a\sqrt{3}}{2})$ are mapped onto ellipsoidal scatterers $(x'_0, y'_0) + \varepsilon(\cos \theta - \frac{\sin \theta}{\sqrt{3}}, \frac{2\sin \theta}{\sqrt{3}})$ centered at $(x'_0, y'_0) = (q, a) = T(x_0, y_0)$. The channel of width $w = 2\varepsilon$, bounded by the two lines of slope $t = \tan \omega$ and tangent to the circle $S_{q,a,\varepsilon}$, is mapped (see Figure 4) onto the channel of width $w' = 2\varepsilon' \cos \omega'$, bounded by the two lines tangent to the ellipse $T(S_{q,a,\varepsilon})$, of slope $t' = \tan \omega' = \Psi(t)$, where

$$\Psi : \left[0, \frac{1}{\sqrt{3}} \right] \rightarrow [0, 1], \quad t' = \Psi(t) = \frac{2t}{\sqrt{3} - t}, \quad t = \Psi^{-1}(t') = \frac{t' \sqrt{3}}{t' + 2}.$$

The intersection of these two channels and the x -axis is the horizontal segment centered at the origin, of length

$$\frac{2\varepsilon}{\sin \omega} = \frac{w}{\sin \omega} = \frac{w'}{\sin \omega'} = \frac{2\varepsilon'}{\tan \omega'}.$$

In particular

$$\varepsilon' = \varepsilon'(\omega, \varepsilon) = \frac{\varepsilon \tan \omega'}{\sin \omega} = \frac{\varepsilon}{\cos(\pi/6 + \omega)}. \quad (2.1)$$

We can first replace each circular scatterer $S_{q,a,\varepsilon}$ by the segment $\tilde{S}_{q,a,\varepsilon}$ centered at (x_0, y_0) , of slope $\frac{\pi}{3}$ and length $\frac{2\varepsilon}{\cos(\pi/6 + \omega)} = 2\varepsilon'$ (see Figures 3 and 4). Indeed, this change will result in altering, for

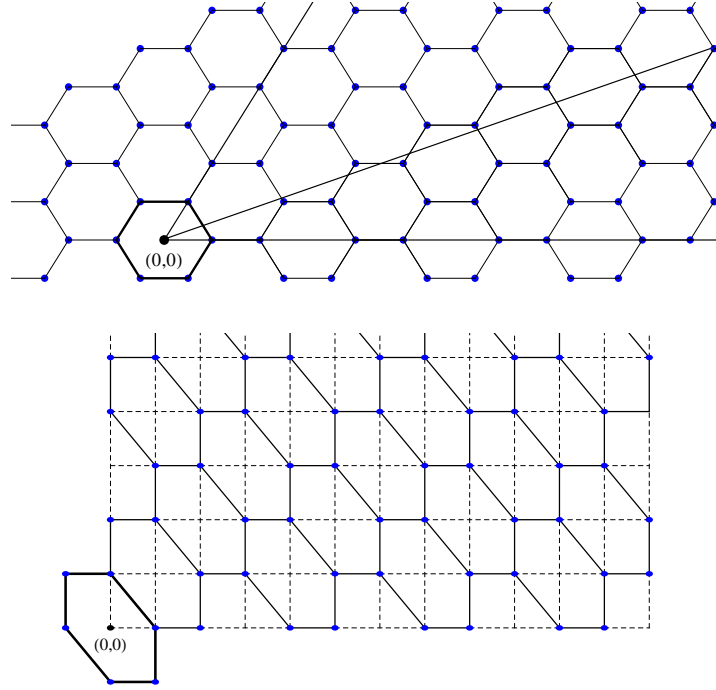

FIGURE 3. The free path length in the honeycomb and in the deformed honeycomb

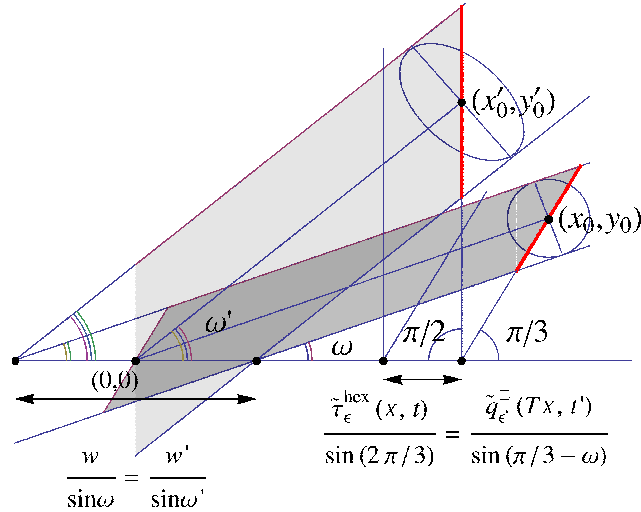

FIGURE 4. Change of scatterers under the linear transformation T

each ω , the free path length $\tau_\epsilon^{\text{hex}}(\mathbf{x}, t)$ to the free path length $\tilde{\tau}_\epsilon^{\text{hex}}(\mathbf{x}, t)$ corresponding to the later model by a quantity lesser than $4\sqrt{3}\epsilon^2$, which is insignificant for the final result.

Next we apply T to transport the problem from the honeycomb to the square lattice with congruence (mod 3) constraints (or in the opposite direction through T^{-1}). The unit regular hexagon H centered at the origin is mapped to the hexagon $T(H)$ which contains $(0, 0)$ in Figure 4. Actually it will be more convenient to replace $T(H)$ by the fundamental domain F consisting of the union of

the square $[0, 1]^2$ and of its translates $[-1, 0) \times [0, 1)$ and $[0, 1) \times [-1, 0)$. Let $\varepsilon' = \varepsilon'(\omega, \varepsilon)$ be as in (2.1), $t' = \tan \omega'$ as above, and consider the vertical segment $V_{\varepsilon'} = \{0\} \times [-\varepsilon', \varepsilon']$. Consider

$$\tilde{q}_{\varepsilon'}^{\square}(\mathbf{x}', t') = \inf\{n \in \mathbb{N}_0 : \mathbf{x}' + (n, nt') \in \mathbb{Z}_{(3)}^2 + V_{\varepsilon'}\},$$

the *horizontal free path length* in the square lattice with vertical scatterers of (nonconstant) length $2\varepsilon'$ centered at points $(x'_0, y'_0) = (q, a) \in \mathbb{Z}_{(3)}^2$. Consider also $q_{\varepsilon_0}^{\square}(\mathbf{x}', t')$, the horizontal free path in the square lattice with vertical scatterers of *constant* length $2\varepsilon_0$ centered at points $(x'_0, y'_0) = (q, a) \in \mathbb{Z}_{(3)}^2$. Clearly $q_{\varepsilon_+}^{\square}(\mathbf{x}', t') \leq \tilde{q}_{\varepsilon'}^{\square}(\mathbf{x}', t') \leq q_{\varepsilon_-}^{\square}(\mathbf{x}', t')$ when t' belongs to an interval I' and $\varepsilon_- \leq \varepsilon' = \varepsilon'(t') \leq \varepsilon_+$, $\forall t' \in I'$.

For each angle ω' the transformation T maps H onto F and T^{-1} preserves the structure of channels in the corresponding three-strip partition from [1, 7, 9] (see also the expository paper [13]). Removal of vertical scatterers $V_{q,a,\varepsilon'} = T(\tilde{S}_{q,a,\varepsilon})$ with $q \equiv a \pmod{3}$ in the $\mathbb{Z}_{(3)}^2$ picture results in dividing the corresponding channel of the three-strip partition from the square lattice model into several sub-channels, and in the occurrence of longer trajectories associated with them. This is transported by T^{-1} back to the honeycomb model. The key observation here is that, by the Rule of Sines,

$$\frac{\tilde{\tau}_{\varepsilon}^{\text{hex}}(\mathbf{x}, t)}{\sin(2\pi/3)} = \frac{\tilde{q}_{\varepsilon'}^{\square}(T\mathbf{x}, t')}{\sin(\pi/3 - \omega)} = \frac{\tilde{q}_{\varepsilon'}^{\square}(T\mathbf{x}, t')}{\cos(\pi/6 + \omega)}.$$

This shows that

$$\tilde{\tau}_{\varepsilon}^{\text{hex}}(\mathbf{x}, t) > \frac{\xi}{\varepsilon} \iff \tilde{q}_{\varepsilon'}^{\square}(T\mathbf{x}, t') > \frac{2\xi \cos(\pi/6 + \omega)}{\varepsilon \sqrt{3}} = \frac{\xi'}{\varepsilon'}, \quad \xi' := \frac{2\xi}{\sqrt{3}}, \quad (2.2)$$

leading to

$$\chi_{(\frac{\xi}{\varepsilon}, \infty)}\left(\tilde{\tau}_{\varepsilon}^{\text{hex}}(\mathbf{x}, t)\right) = \chi_{(\frac{\xi'}{\varepsilon'}, \infty)}\left(\tilde{q}_{\varepsilon'}^{\square}(T\mathbf{x}, t')\right), \quad \forall \mathbf{x} \in H, \forall t \in \left[0, \frac{1}{\sqrt{3}}\right].$$

For each interval $I = [\tan \omega_0, \tan \omega_1] \subseteq [0, \frac{1}{\sqrt{3}}]$ one has

$$\varepsilon_I^- := \frac{\varepsilon}{\cos(\pi/6 + \omega_0)} \leq \varepsilon' = \frac{\varepsilon}{\cos(\pi/6 + \omega)} \leq \varepsilon_I^+ := \frac{\varepsilon}{\cos(\pi/6 + \omega_1)},$$

$$\varepsilon_I^{\pm} = (1 + O(|I|))\varepsilon.$$

Employing now (2.2) and the fact that $\varepsilon \mapsto \tilde{q}_{\varepsilon}^{\square}(T\mathbf{x}, t')$ is non-decreasing, and taking

$$\xi_I^- := \frac{\xi' \varepsilon_I^-}{\varepsilon_I^+} \leq \xi' \leq \xi_I^+ := \frac{\xi' \varepsilon_I^+}{\varepsilon_I^-}, \quad \xi_I^{\pm} = (1 + O(|I|))\xi',$$

we infer

$$\begin{aligned} \chi_{(\frac{\xi_I^+}{\varepsilon_I^+}, \infty)}\left(q_{\varepsilon_I^+}^{\square}(T\mathbf{x}, t')\right) &= \chi_{(\frac{\xi'}{\varepsilon'}, \infty)}\left(q_{\varepsilon_I^+}^{\square}(T\mathbf{x}, t')\right) \leq \chi_{(\frac{\xi'}{\varepsilon'}, \infty)}\left(q_{\varepsilon_I^+}^{\square}(T\mathbf{x}, t')\right) \\ &\leq \chi_{(\frac{\xi'}{\varepsilon'}, \infty)}\left(\tilde{q}_{\varepsilon'}^{\square}(T\mathbf{x}, t')\right) = \chi_{(\frac{\xi}{\varepsilon}, \infty)}\left(\tilde{\tau}_{\varepsilon}^{\text{hex}}(\mathbf{x}, t)\right) \leq \chi_{(\frac{\xi'}{\varepsilon'}, \infty)}\left(q_{\varepsilon_I^-}^{\square}(T\mathbf{x}, t')\right) \\ &\leq \chi_{(\frac{\xi'}{\varepsilon'}, \infty)}\left(q_{\varepsilon_I^-}^{\square}(T\mathbf{x}, t')\right) = \chi_{(\frac{\xi_I^-}{\varepsilon_I^-}, \infty)}\left(q_{\varepsilon_I^-}^{\square}(T\mathbf{x}, t')\right). \end{aligned}$$

Consider

$$\mathbb{G}_{I,\varepsilon}(\xi) := \int_{\Psi(I)} \frac{dt'}{t'^2 + t' + 1} \int_F d\mathbf{x}' \chi_{(\frac{\xi}{\varepsilon}, \infty)}\left(q_{\varepsilon}^{\square}(\mathbf{x}', t')\right). \quad (2.3)$$

Applying the change of variable $(\mathbf{x}', t') = (T\mathbf{x}, \Psi(t))$ and employing (2.3), $d\mathbf{x} = \frac{\sqrt{3}}{2}d\mathbf{x}'$ and $\frac{dt}{t^2+1} = \frac{\sqrt{3}}{2} \cdot \frac{dt'}{t'^2+t'+1}$ we infer

$$\begin{aligned} \frac{3}{4} \mathbb{G}_{I, \varepsilon_I^+}(\xi_I^+) &\leq \frac{3}{4} \int_{\Psi(I)} \frac{dt'}{t'^2+t'+1} \int_F d\mathbf{x}' \chi_{\left(\frac{\xi_I^+}{\varepsilon_I^+}, \infty\right)}(q_{\varepsilon_I^+}^\square(\mathbf{x}', t')) \\ &\leq \widetilde{\mathbb{P}}_{I, \varepsilon}(\xi) := \iint_{H \times I} \chi_{\left(\frac{\xi}{\varepsilon}, \infty\right)}(\tilde{\tau}_\varepsilon^{\text{hex}}(\mathbf{x}, \omega)) d\mathbf{x} d\omega \\ &= \int_I \frac{dt}{t^2+1} \int_H d\mathbf{x} \chi_{\left(\frac{\xi}{\varepsilon}, \infty\right)}(\tilde{\tau}_\varepsilon^{\text{hex}}(\mathbf{x}, t)) \\ &\leq \frac{3}{4} \int_{\Psi(I)} \frac{dt'}{t'^2+t'+1} \int_F d\mathbf{x}' \chi_{\left(\frac{\xi_I^-}{\varepsilon_I^-}, \infty\right)}(q_{\varepsilon_I^-}^\square(\mathbf{x}', t')) = \frac{3}{4} \mathbb{G}_{I, \varepsilon_I^-}(\xi_I^-). \end{aligned}$$

To simplify notation we simply denote $\mathbb{G}_{I, 1/(2Q)}$ by $\mathbb{G}_{I, Q}$ throughout. We shall employ the following result, whose proof occupies the remaining part of the paper.

Theorem 2. *Let $c, c' > 0$ such that $c + c' < 1$. For every interval $I \subseteq [0, 1]$ of length $|I| \asymp Q^c$, every $\xi \geq 0$ and $\delta > 0$, uniformly for ξ in compact subsets K of $[0, \infty)$,*

$$\mathbb{G}_{I, Q}(\xi) = \frac{2c_I}{\zeta(2)} G(\xi) + O_{\delta, K}(E_{c, c', \delta}(Q)), \quad (2.4)$$

where $G(\xi)$ is the 40 term sum described below (1.3) and

$$c_I = \int_I \frac{dt}{t^2+t+1}, \quad c_{[0,1]} = \frac{\pi}{3\sqrt{3}},$$

$$E_{c, c', \delta}(Q) = Q^{\max\{2c' - \frac{1}{2}, -c - c'\} + \delta}. \quad (2.5)$$

Proof. Proof of Theorem 1. Let $Q^- = Q_I^- := \lfloor \frac{1}{2\varepsilon_I^-} \rfloor + 1$ and $\frac{\varepsilon_I^-}{1+2\varepsilon_I^-} \leq \varepsilon^- := \frac{1}{2Q^-} \leq \varepsilon_I^-$. Then $q_{\varepsilon_I^-}^\square(\mathbf{x}', t') \leq q_{\varepsilon^-}^\square(\mathbf{x}', t')$, so $\chi_{\left(\frac{\xi_I^-}{\varepsilon_I^-}, \infty\right)}(q_{\varepsilon_I^-}^\square(\mathbf{x}', t')) \leq \chi_{\left(\frac{\xi_I^-}{\varepsilon_I^-}, \infty\right)}(q_{\varepsilon^-}^\square(\mathbf{x}', t'))$. Similarly, taking $Q^+ = Q_I^+ := \lfloor \frac{1}{2\varepsilon_I^+} \rfloor$, $\varepsilon_I^+ \leq \varepsilon^+ := \frac{1}{2Q^+} \leq \frac{\varepsilon_I^+}{1-2\varepsilon_I^+}$, we have $\chi_{\left(\frac{\xi_I^+}{\varepsilon_I^+}, \infty\right)}(q_{\varepsilon_I^+}^\square(\mathbf{x}', t')) \geq \chi_{\left(\frac{\xi_I^+}{\varepsilon_I^+}, \infty\right)}(q_{\varepsilon^+}^\square(\mathbf{x}', t'))$. On the other hand $\frac{\varepsilon^\pm}{\varepsilon_I^\pm} = 1 + O(\varepsilon)$, hence

$$\frac{\xi_I^\pm}{\varepsilon_I^\pm} = \frac{\xi_I^\pm}{\varepsilon^\pm} \cdot \frac{\varepsilon^\pm}{\varepsilon_I^\pm} = (1 + O(|I|)) \frac{\xi'}{\varepsilon^\pm}.$$

We now infer

$$\begin{aligned} \mathbb{G}_{I, Q^+}((1 + O(|I|))\xi') &\leq \frac{3}{4} \mathbb{G}_{I, \varepsilon_I^+}(\xi_I^+) \leq \widetilde{\mathbb{P}}_{I, \varepsilon}(\xi) \\ &\leq \frac{3}{4} \mathbb{G}_{I, \varepsilon_I^-}(\xi_I^-) \leq \frac{3}{4} \mathbb{G}_{I, Q^-}((1 + O(|I|))\xi'). \end{aligned} \quad (2.6)$$

Partition now the interval $[0, \frac{1}{\sqrt{3}}]$ as a union of $N = \lceil \varepsilon^{-c} \rceil$ intervals $I_j = [\tan \omega_j, \tan \omega_{j+1}]$ of equal length $|I_j| = \frac{1}{N} \asymp \varepsilon^c$, with $0 < c < 1$ to be chosen later. As above, consider $Q_j^\pm = Q_{I_j}^\pm$. The intervals $\Psi(I_j)$ partition $[0, 1]$ and $|\Psi(I_j)| \asymp \varepsilon^c$. Applying (2.6), Theorem 2 and the property of G of being

Lipschitz on the compact K we infer

$$\begin{aligned} \mathbb{P}_\varepsilon^{\text{hex}}(\xi) &= \frac{6}{\pi|H|} \sum_{j=1}^N \widetilde{\mathbb{P}}_{I_j, \varepsilon}(\xi) = \frac{\sqrt{3}}{\pi} \sum_{j=1}^N \mathbb{G}_{I_j, \mathcal{Q}_j^*}(\xi) \\ &= \frac{2\sqrt{3}}{\pi\zeta(2)} \sum_{j=1}^N c_{I_j} G\left(\left(1 + O(|I|)\right) \frac{2\xi}{\sqrt{3}}\right) + O_{\delta, K}(N\varepsilon^{-\max\{2c_1 - \frac{1}{2}, -c - c_1\}}) \\ &= \frac{2c_{[0,1]}\sqrt{3}}{\pi\zeta(2)} G\left(\frac{2\xi}{\sqrt{3}}\right) + O_{\delta, K}(\varepsilon^{-c} + \varepsilon^{-\max\{c+2c_1 - \frac{1}{2}, -c_1\} - \delta}), \end{aligned}$$

uniformly for ξ in compacts of $[0, \infty)$. Taking $c = c_1 = \frac{1}{8}$ we find

$$\mathbb{P}_\varepsilon^{\text{hex}}(\xi) = \frac{4}{\pi^2} G\left(\frac{2\xi}{\sqrt{3}}\right) + O_{\delta, K}(\varepsilon^{\frac{1}{8} - \delta}),$$

as stated in Theorem 1 and in (1.3). \square

3. SOME NUMBER THEORETICAL ESTIMATES

In this section we review and prove some number theoretical estimates that will be further used to estimate certain sums over integer lattice points with congruence constraints. The principal Dirichlet character $(\text{mod } \ell)$ will be denoted by χ_0 . The number of divisors of N is denoted by $\sigma_0(N)$.

Lemma 1 (Lemma 2.2 of [2]). *For each function $f \in C^1[0, N]$ with total variation $T_0^N f$,*

$$\sum_{\substack{1 \leq q \leq N \\ (q, \ell) = 1}} f(q) = \frac{\varphi(\ell)}{\ell} \int_0^N f(x) dx + O(\|f\|_\infty + T_0^N f) \sigma_0(N).$$

Lemma 2 (Lemma 2.1 of [3]). *For each function $V \in C^1[0, N]$,*

$$\sum_{\substack{1 \leq q \leq N \\ (q, \ell) = 1}} \frac{\varphi(q)}{q} V(q) = C(\ell) \int_0^N V(x) dx + O_\ell(\|V\|_\infty + T_0^N V) \log N,$$

where

$$C(\ell) = \frac{\varphi(\ell)}{\zeta(2)\ell} \prod_{\substack{p \in \mathcal{P} \\ p|\ell}} \left(1 - \frac{1}{p^2}\right)^{-1} = \frac{1}{\zeta(2)} \prod_{\substack{p \in \mathcal{P} \\ p|\ell}} \left(1 + \frac{1}{p}\right)^{-1} = \frac{\varphi(\ell)}{\ell L(2, \chi_0)}.$$

We need a more precise form of Lemma 1, as follows:

Lemma 3. *Suppose that $(r, \ell) = 1$. For each function $V \in C^1[0, N]$,*

$$\sum_{\substack{1 \leq q \leq N \\ q \equiv r \pmod{\ell}}} \frac{\varphi(q)}{q} V(q) = \frac{C(\ell)}{\varphi(\ell)} \int_0^N V(x) dx + O_\ell(\|V\|_\infty + T_0^N V) \log N.$$

In particular

$$\sum_{\substack{1 \leq q \leq N \\ q \equiv \pm 1 \pmod{3}}} \frac{\varphi(q)}{q} V(q) \sim \frac{3}{8\zeta(2)} \int_0^N V(x) dx, \quad \sum_{\substack{1 \leq q \leq N \\ q \equiv 0 \pmod{3}}} \frac{\varphi(q)}{q} V(q) \sim \frac{1}{4\zeta(2)} \int_0^N V(x) dx.$$

Proof. When $(k, \ell) = 1$ denote by \bar{k} the multiplicative inverse of $k \pmod{\ell}$. Let $G = U(\mathbb{Z}/\ell\mathbb{Z})$ denote the multiplicative group of units of $\mathbb{Z}/\ell\mathbb{Z}$ and \widehat{G} be the group of characters $\chi : G \rightarrow \mathbb{T}$, extended as multiplicative functions on \mathbb{N} . Set $V_d(x) = V(xd)$. By Schur's orthogonality relations for characters, for every $x, s \in \mathbb{N}$ with $(s, \ell) = 1$,

$$\frac{1}{\varphi(\ell)} \sum_{\chi \in \widehat{G}} \chi(x)\chi(\bar{s}) = \frac{1}{\varphi(\ell)} \sum_{\chi \in \widehat{G}} \chi(x)\overline{\chi(s)} = \begin{cases} 1 & \text{if } x \equiv s \pmod{\ell}, \\ 0 & \text{if } x \not\equiv s \pmod{\ell}. \end{cases} \quad (3.1)$$

Taking $s = r$ and summing over $x = q \leq N$, we infer by Möbius summation, with $q = md$,

$$\begin{aligned} \sum_{\substack{q \leq N \\ q \equiv r \pmod{\ell}}} \frac{\varphi(q)}{q} V(q) &= \frac{1}{\varphi(\ell)} \sum_{q \leq N} \frac{\varphi(q)}{q} V(q) \sum_{\chi \in \widehat{G}} \chi(q)\chi(\bar{r}) \\ &= \frac{1}{\varphi(\ell)} \sum_{q \leq N} \sum_{d|q} \frac{\mu(d)}{d} V(q) \sum_{\chi \in \widehat{G}} \chi(q)\chi(\bar{r}) \\ &= \frac{1}{\varphi(\ell)} \sum_{d \leq N} \sum_{m=1}^{\lfloor N/d \rfloor} \sum_{\chi \in \widehat{G}} \frac{\mu(d)}{d} V_d(m)\chi(md)\chi(\bar{r}) \\ &= \frac{1}{\varphi(\ell)} \sum_{\chi \in \widehat{G}} \chi(\bar{r}) \sum_{d \leq N} \frac{\mu(d)\chi(d)}{d} \sum_{m=1}^{\lfloor N/d \rfloor} V_d(m)\chi(m). \end{aligned} \quad (3.2)$$

We split the inner sum above according to whether $\chi = \chi_0$ or $\chi \neq \chi_0$. Employing Lemma 1 for the function V_d we find that the contribution of the former is

$$\begin{aligned} &\frac{1}{\varphi(\ell)} \sum_{d \leq N} \frac{\mu(d)\chi_0(d)}{d} \left(\frac{\varphi(\ell)}{\ell} \int_0^{\lfloor N/d \rfloor} V_d + O(\|V_d\|_\infty + T_0^{N/d} V_d) \log N \right) \\ &= \frac{1}{\ell} \left(\sum_{d \leq N} \frac{\mu(d)\chi_0(d)}{d^2} \right) \int_0^N V + O_\ell(\|V\|_\infty + T_0^N V) \log N \\ &= \left(\frac{1}{\ell L(2, \chi_0)} + O_\ell\left(\frac{1}{N}\right) \right) \int_0^N V + O_\ell(\|V\|_\infty + T_0^N V) \log N \\ &= \frac{C(\ell)}{\varphi(\ell)} \int_0^N V + O_\ell(\|V\|_\infty + T_0^N V) \log N. \end{aligned}$$

When $\chi \neq \chi_0$ we find by partial summation and Pólya-Vinogradov (or a weaker inequality) that the innermost sum in (3.2) is $\ll_\ell T_0^N V + \|V\|_\infty$, so the total contribution of non-principal characters in (3.2) is $\ll_\ell \|V\|_\infty \log N$. The proof is complete. \square

Lemma 4 (Proposition A4 of [6]). *Assume that $q \geq 1$ and h are integers, \mathcal{I} and \mathcal{J} are intervals of length less than q , and $f \in C^1(\mathcal{I} \times \mathcal{J})$. For any integer $T > 1$ and any $\delta > 0$*

$$\sum_{\substack{a \in \mathcal{I}, b \in \mathcal{J} \\ (a, q) = 1 \\ ab \equiv h \pmod{q}}} f(a, b) = \frac{\varphi(q)}{q^2} \iint_{\mathcal{I} \times \mathcal{J}} f(x, y) dx dy + \mathcal{E},$$

with

$$\mathcal{E} \ll_{\delta} T^2 \|f\|_{\infty} q^{\frac{1}{2} + \delta} (h, q)^{\frac{1}{2}} + T \|\nabla f\|_{\infty} q^{\frac{3}{2} + \delta} (h, q)^{\frac{1}{2}} + \frac{\|\nabla f\|_{\infty} |\mathcal{I}| |\mathcal{J}|}{T},$$

where $\|f\|_{\infty}$ and $\|\nabla f\|_{\infty}$ denote the sup-norm of f and respectively $\left| \frac{\partial f}{\partial x} \right| + \left| \frac{\partial f}{\partial y} \right|$ on $\mathcal{I} \times \mathcal{J}$.

For q, ℓ positive integers denote

$$A(q, \ell) = \begin{cases} 1 & \text{if } (q, \ell) = 1, \\ \prod_{\substack{p \in \mathcal{P} \\ p | (q, \ell)}} \left(1 - \frac{1}{p}\right)^{-1} & \text{if } (q, \ell) > 1. \end{cases}$$

Lemma 5. *Suppose that $(r, \ell) = 1$. For any interval \mathcal{I} , uniformly in $|\mathcal{I}|$,*

$$\sum_{\substack{x \in \mathcal{I}, (x, q) = 1 \\ x \equiv r \pmod{\ell}}} 1 = \frac{A(q, \ell)}{\ell} \cdot \frac{\varphi(q)}{q} |\mathcal{I}| + O(\sigma_0(q)).$$

Proof. Without loss of generality assume $\mathcal{I} = [1, N]$. As in the proof of Lemma 3 take $s = r$ and sum in (3.1) over $x \in \mathcal{I}$ with $(x, q) = 1$. By Möbius inversion with $x = md$ we infer

$$\begin{aligned} \sum_{\substack{x \in \mathcal{I}, (x, q) = 1 \\ x \equiv r \pmod{\ell}}} 1 &= \frac{1}{\varphi(\ell)} \sum_{\substack{x \in \mathcal{I} \\ (x, q) = 1}} \sum_{\chi \in \widehat{G}} \chi(x) \chi(\bar{r}) = \frac{1}{\varphi(\ell)} \sum_{\chi \in \widehat{G}} \sum_{x \in \mathcal{I}} \chi(x) \chi(\bar{r}) \sum_{\substack{d|q \\ d|x}} \mu(d) \\ &= \frac{1}{\varphi(\ell)} \sum_{d|q} \mu(d) \sum_{\substack{x \in \mathcal{I} \\ d|x}} \sum_{\chi \in \widehat{G}} \chi(x) \chi(\bar{r}) = \frac{1}{\varphi(\ell)} \sum_{d|q} \mu(d) \sum_{m=1}^{\lfloor N/d \rfloor} \sum_{\chi \in \widehat{G}} \chi(md) \chi(\bar{r}). \end{aligned} \quad (3.3)$$

The contribution of $\chi = \chi_0$ to (3.3) is

$$\begin{aligned} \frac{1}{\varphi(\ell)} \sum_{d|q} \mu(d) \chi_0(d) \sum_{\substack{1 \leq m \leq \lfloor N/d \rfloor \\ (m, \ell) = 1}} 1 &= \frac{1}{\varphi(\ell)} \sum_{d|q} \mu(d) \chi_0(d) \left(\frac{\varphi(\ell)}{\ell} \left(\frac{N}{d} + O(1) \right) \right) \\ &= \frac{|\mathcal{I}|}{\ell} \sum_{d|q} \frac{\mu(d) \chi_0(d)}{d} + O(\sigma_0(q)). \end{aligned} \quad (3.4)$$

In the contribution of non-principal characters to (3.3),

$$\frac{1}{\varphi(\ell)} \sum_{d|q} \mu(d) \sum_{\substack{\chi \in \widehat{G} \\ \chi \neq \chi_0}} \chi(d) \chi(\bar{r}) \sum_{m=1}^{\lfloor N/d \rfloor} \chi(m), \quad (3.5)$$

the innermost sum is $\ll_{\ell} 1$ (by Pólya-Vinogradov or a weaker inequality), showing that the quantity in (3.5) is $\ll_{\ell} \sigma_0(q)$. The statement follows now because the sum in (3.4) is equal to $\sum_{d|q} \frac{\mu(d)}{d} = \frac{\varphi(q)}{q}$ when $(q, \ell) = 1$, while when $(q, \ell) > 1$, writing $q = p_1^{\alpha_1} \cdots p_r^{\alpha_r} \tilde{q}$ with p_1, \dots, p_r prime divisors of ℓ and $(\tilde{q}, \ell) = 1$, this sum is equal to

$$\sum_{d|\tilde{q}} \frac{\mu(d)}{d} = \frac{\varphi(\tilde{q})}{\tilde{q}} = \frac{\varphi(q)}{q} \prod_{i=1}^r \left(1 - \frac{1}{p_i}\right)^{-1} = A(q, \ell) \frac{\varphi(q)}{q},$$

as desired. \square

We also need a slight extension of Lemma 4. Suppose that $(r, \ell) = 1$ and denote by \bar{x} the multiplicative inverse of $x \pmod{\ell q}$ when $(x, \ell q) = 1$. The Kloosterman type sums

$$K(m, n; \ell q) := \sum_{\substack{x \pmod{\ell q} \\ (x, \ell q) = 1}} e\left(\frac{mx + n\bar{x}}{\ell q}\right), \quad \widetilde{K}_r(m, n; \ell q) := \sum_{\substack{x \pmod{\ell q} \\ (x, q) = 1, x \equiv r \pmod{\ell}}} e\left(\frac{mx + n\bar{x}}{\ell q}\right),$$

$$K_{\mathcal{I}, r}(m, n; \ell q) := \sum_{\substack{x \in \mathcal{I}, (x, q) = 1 \\ x \equiv r \pmod{\ell q}}} e\left(\frac{mx + n\bar{x}}{\ell q}\right),$$

will be used to estimate

$$\widetilde{N}_{q, \ell, r, h}(\mathcal{I}_1, \mathcal{I}_2) := \#\{(x, y) \in \mathcal{I}_1 \times \mathcal{I}_2 : (x, q) = 1, x \equiv r \pmod{\ell}, xy \equiv h \pmod{\ell q}\}$$

Lemma 6. *When $(r, \ell) = 1$, for any interval \mathcal{I} of length less than q ,*

$$|K_{\mathcal{I}, r}(0, n; \ell q)| \ll_{\ell, \delta} (n, q)^{\frac{1}{2}} q^{\frac{1}{2} + \delta}.$$

Proof. We write

$$\begin{aligned} K_{\mathcal{I}, r}(0, n; \ell q) &= \sum_{\substack{x \in \mathcal{I}, (x, q) = 1 \\ x \equiv r \pmod{\ell}}} e\left(\frac{n\bar{x}}{\ell q}\right) = \sum_{\substack{x \pmod{\ell q} \\ (x, q) = 1, x \equiv r \pmod{\ell}}} e\left(\frac{n\bar{x}}{\ell q}\right) \sum_{y \in \mathcal{I}} \frac{1}{\ell q} \sum_{k \pmod{\ell q}} e\left(\frac{k(y - x)}{\ell q}\right) \\ &= \frac{1}{\ell q} \sum_{k \pmod{\ell q}} \widetilde{K}_r(-k, n; \ell q) \sum_{y \in \mathcal{I}} e\left(\frac{ky}{\ell q}\right), \end{aligned}$$

and

$$\begin{aligned} |\widetilde{K}_r(m, n; \ell q)| &= \left| \sum_{\substack{x \pmod{\ell q} \\ (x, \ell q) = 1}} e\left(\frac{mx + n\bar{x}}{\ell q}\right) \frac{1}{\ell} \sum_{j \pmod{\ell}} e\left(\frac{j(x - r)}{\ell}\right) \right| \\ &= \frac{1}{\ell} \left| \sum_{j \pmod{\ell}} e\left(-\frac{jr}{\ell}\right) K(m + jq, n; \ell q) \right| \leq \max_j |K(m + jq, n; \ell q)|. \end{aligned}$$

Employing¹

$$\left| \sum_{y \in \mathcal{I}} e\left(\frac{ky}{\ell q}\right) \right| \leq \min \left\{ |\mathcal{I}| + 1, \frac{1}{2 \left\| \frac{k}{\ell q} \right\|} \right\}, \quad (3.6)$$

$$|K(0, n; \ell q)| = |c_{\ell q}(n)| \leq (n, \ell q) \leq (n, q)\ell \ll_{\ell} (n, q)^{\frac{1}{2}} q^{\frac{1}{2}},$$

and the Weil estimate

$$|K(m + jq, n; \ell q)| \leq \sigma_0(\ell q)(m + jq, n, \ell q)^{\frac{1}{2}} (\ell q)^{\frac{1}{2}} \ll_{\ell, \delta} (n, q)^{\frac{1}{2}} q^{\frac{1+\delta}{2}},$$

we infer

$$\begin{aligned} |K_{\mathcal{I}, r}(0, n; \ell q)| &\leq \frac{|\mathcal{I}| + 1}{\ell q} |\widetilde{K}_r(0, n; \ell q)| + \frac{1}{\ell q} \sum_{\substack{k \pmod{\ell q} \\ k \neq 0}} \frac{|\widetilde{K}_r(-k, n; \ell q)|}{\left\| \frac{k}{\ell q} \right\|} \\ &\ll_{\ell, \delta} (n, q)^{\frac{1}{2}} q^{\frac{1+\delta}{2}} + \frac{1}{2\ell q} \cdot (n, q)^{\frac{1}{2}} q^{\frac{1+\delta}{2}} \ell q \log(\ell q) \ll_{\ell} (n, q)^{\frac{1}{2}} q^{\frac{1}{2} + \delta}, \end{aligned}$$

¹Here $\|x\| = \text{dist}(x, \mathbb{Z})$, $x \in \mathbb{R}$, and $c_q(n) = K(n, 0; q) = K(0, n; q)$ is the Ramanujan sum.

as desired. \square

Lemma 7. *Suppose that $(r, \ell) = 1$. For any intervals \mathcal{I}_1 and \mathcal{I}_2 of length less than q , any integer h and any $\delta > 0$,*

$$\widetilde{N}_{q,\ell,r,h}(\mathcal{I}_1, \mathcal{I}_2) = \frac{A(q, \ell)}{\ell^2} \cdot \frac{\varphi(q)}{q^2} |\mathcal{I}_1| |\mathcal{I}_2| + O_{\ell,\delta} \left((h, q)^{\frac{1}{2}} q^{\frac{1}{2}+\delta} \right).$$

Proof. We write

$$\widetilde{N}_{q,\ell,r,h}(\mathcal{I}_1, \mathcal{I}_2) = \sum_{\substack{x \in \mathcal{I}_1, y \in \mathcal{I}_2 \\ (x,q)=1, x \equiv r \pmod{\ell}}} \frac{1}{\ell q} \sum_{k \pmod{\ell q}} e \left(\frac{k(y - h\bar{x})}{\ell q} \right) = M + E,$$

where \bar{x} denotes the multiplicative inverse of $x \pmod{\ell q}$ and

$$\begin{aligned} E &= \frac{1}{\ell q} \sum_{\substack{k \pmod{\ell q} \\ k \neq 0}} \left(\sum_{y \in \mathcal{I}_2} e \left(\frac{ky}{\ell q} \right) \right) K_{\mathcal{I}_1, r}(0, -hk; \ell q), \\ M &= \frac{1}{\ell q} \sum_{\substack{x \in \mathcal{I}_1, y \in \mathcal{I}_2 \\ (x,q)=1, x \equiv r \pmod{\ell}}} 1 = \frac{1}{\ell q} \left(\frac{A(q, \ell)}{\ell} \cdot \frac{\varphi(q)}{q} |\mathcal{I}_1| + O(\sigma_0(q)) \right) (|\mathcal{I}_2| + O(1)) \\ &= \frac{A(q, \ell)}{\ell^2} \cdot \frac{\varphi(q)}{q^2} |\mathcal{I}_1| |\mathcal{I}_2| + O_{\ell}(\sigma_0(q)). \end{aligned} \quad (3.7)$$

From (3.6), Lemma 6 and $(hk, \ell q) \leq (h, q)(k, q)\ell$, we infer as in the proof of [6, Proposition A.3]

$$\begin{aligned} |E| &\ll_{\ell,\delta} q^{-\frac{1}{2}+\frac{\delta}{2}} \sum_{\substack{k \pmod{\ell q} \\ k \neq 0}} \frac{(hk, \ell q)^{1/2}}{\| \frac{k}{\ell q} \|} \ll_{\ell,\delta} q^{-\frac{1}{2}+\frac{\delta}{2}} (h, q)^{\frac{1}{2}} \sum_{\substack{k \pmod{\ell q} \\ k \neq 0}} \frac{(k, q)^{1/2}}{\| \frac{k}{\ell q} \|} \\ &\ll q^{\frac{1+\delta}{2}} (h, q)^{\frac{1}{2}} \sum_{1 \leq k \leq (q-1)/2} \frac{(k, q)^{1/2}}{k} \ll_{\delta} (h, q)^{\frac{1}{2}} q^{\frac{1}{2}+\delta}. \end{aligned} \quad (3.8)$$

The statement follows now from (3.7) and (3.8). \square

Lemma 8. *Suppose that $(r, \ell) = 1$. Let $\mathcal{I}_1, \mathcal{I}_2$ be intervals of length less than q , $f \in C^1(\mathcal{I}_1 \times \mathcal{I}_2)$, and $h \in \mathbb{Z}$. For any integer $T > 1$ and any $\delta > 0$,*

$$\sum_{\substack{x \in \mathcal{I}_1, y \in \mathcal{I}_2 \\ (x,q)=1, x \equiv r \pmod{\ell} \\ xy \equiv h \pmod{\ell q}}} f(x, y) = \frac{A(q, \ell)}{\ell^2} \cdot \frac{\varphi(q)}{q^2} \iint_{\mathcal{I}_1 \times \mathcal{I}_2} f(u, v) du dv + \mathcal{E},$$

with

$$\mathcal{E} \ll_{\ell,\delta} T^2 \|f\|_{\infty} q^{\frac{1}{2}+\delta} (h, q)^{\frac{1}{2}} + T \|\nabla f\|_{\infty} q^{\frac{3}{2}+\delta} (h, q)^{\frac{1}{2}} + \frac{\|\nabla f\|_{\infty} |\mathcal{I}_1| |\mathcal{I}_2|}{T}.$$

Proof. This plainly follows from Lemma 7 as in the proof of [4, Lemma 2.2]. \square

Only the case $\ell = 3$ and $x \equiv r \not\equiv 0 \pmod{3}$ is needed here, with main term given by

$$\sum_{\substack{x \in \mathcal{I}_1, y \in \mathcal{I}_2 \\ (x,q)=1, x \equiv r \pmod{3} \\ xy \equiv h \pmod{3q}}} f(x, y) \sim \frac{\varphi(q)}{q^2} \left(\iint_{\mathcal{I}_1 \times \mathcal{I}_2} f(x, y) dx dy \right) \cdot \begin{cases} \frac{1}{9} & \text{if } 3 \nmid q, \\ \frac{1}{6} & \text{if } 3 \mid q. \end{cases}$$

4. CODING THE LINEAR FLOW IN $\mathbb{Z}_{(3)}^2$ AND THE THREE-STRIP PARTITION

To keep notation short denote

$$x \vee y = \max\{x, y\}, \quad x \wedge y = \min\{x, y\}, \quad x_+ = \max\{x, 0\}.$$

Consider c, c', δ, ξ and I as in the statement of Theorem 2 and $E_{c,c',\delta}(Q)$ as in (2.5). For $(A_Q), (B_Q)$ sequences of real numbers we write $A_Q \cong B_Q$ when $A_Q = B_Q + O_{\delta,\xi}(E_{c,c',\delta}(Q))$, uniformly for ξ in compact subsets of $[0, \infty)$. Our primary aim is to estimate the quantity $\mathbb{G}_{I,Q}(\xi)$ from Theorem 2, associated with lattice points from $\mathbb{Z}_{(3)}^2$ with corresponding vertical scatterers of width $2\varepsilon = \frac{1}{Q}$, as $Q \rightarrow \infty$.

It is useful to recall first the approach and notation from [7]. $\mathcal{F}(Q)$ denotes the set of Farey fractions of order Q , consisting of rational numbers $\gamma = \frac{a}{q}$, $0 < a \leq q \leq Q$, with $(a, q) = 1$. The interval I will be first partitioned into intervals $I_\gamma = (\gamma, \gamma')$ with γ, γ' consecutive in $\mathcal{F}_I(Q) := \mathcal{F}(Q) \cap I$. Each interval I_γ is further partitioned into subintervals $I_{\gamma,k}$, $k \in \mathbb{Z}$, defined as

$$I_{\gamma,k} = (t_k, t_{k-1}], \quad I_{\gamma,0} = (t_0, u_0], \quad I_{\gamma,-k} = (u_{k-1}, u_k], \quad k \in \mathbb{N},$$

where

$$t_k = \frac{a_k - 2\varepsilon}{q_k}, \quad u_k = \frac{a'_k + 2\varepsilon}{q'_k}, \quad k \in \mathbb{N}_0,$$

and

$$q_k = q' + kq, \quad a_k = a' + ka, \quad q'_k = q + kq', \quad a'_k = a + ka', \quad k \in \mathbb{Z},$$

satisfy the fundamental relations

$$\begin{cases} a_{k-1}q_k - a_kq_{k-1} = 1 = a_{k-1}q - aq_{k-1}, \\ a'_kq'_{k-1} - a'_{k-1}q'_k = 1 = a'q'_{k-1} - a'_{k-1}q', & k \in \mathbb{Z}, \\ 2\varepsilon q_k \wedge 2\varepsilon q'_k \geq 2\varepsilon(q + q') > 1, & k \geq 1. \end{cases}$$

Consider also

$$t := \tan \omega \quad \text{and} \quad \gamma_k = \frac{a_k}{q_k}, \quad k \in \mathbb{N}.$$

As it will be seen shortly, the coding of the linear flow is considerably more involved than in the case of the square lattice. As a result our attempt of providing asymptotic results for the repartition of the free path length will require additional partitioning for each of the interval $I_{\gamma,k}$. For symmetry reasons² the mediant intervals $(\gamma, \gamma_1]$ and $(\gamma_1, \gamma']$ will contribute by the same amount to the main term, so we shall only consider $t \in (\gamma, \gamma_1]$ and redefine

$$I_{\gamma,0} := (t_0, t_{-1}], \quad t_{-1} := \gamma_1 = \frac{a' + a}{q' + q}.$$

This explains the appearance of the factor 2 in formula (2.4).

As in [7, Section 3] we shall consider³, when $t = \tan \omega \in I_{\gamma,k}$, $k \in \mathbb{N}_0$,

$$\begin{aligned} w_{\mathcal{A}_0}(t) &= a + 2\varepsilon - qt = q(u_0 - t), & w_{\mathcal{C}_k}(t) &= a_{k-1} - 2\varepsilon - q_{k-1}t = q_{k-1}(t_{k-1} - t), \\ w_{\mathcal{B}_k}(t) &= q_k t - a_k + 2\varepsilon = q_k(t - t_k) \in [0, 2\varepsilon], \end{aligned}$$

²Which are not geometrically obvious but become apparent after translating $\mathbb{G}_{I,Q}(\xi)$ into sums involving (sub)intervals (of) $I_{\gamma,k}$ and Farey fractions from $\mathcal{F}_I(Q)$.

³Here we use $t = \tan \omega$ as variable and use $\frac{dt}{t^2+t+1}$ instead of $d\omega$.

representing the widths of the bottom, center, and respectively top channels \mathcal{A}_0 , \mathcal{C}_k , \mathcal{B}_k , of the three-strip partition of $[0, 1]^2$ (see Figures 5 and 6). Clearly

$$\begin{cases} 2\varepsilon = w_{\mathcal{A}_0}(t) + w_{\mathcal{B}_k}(t) + w_{\mathcal{C}_k}(t), \\ 1 = qw_{\mathcal{A}_0}(t) + q_{k+1}w_{\mathcal{C}_k}(t) + q_kw_{\mathcal{B}_k}(t), \end{cases} \quad \forall t \in I_{\gamma,k}.$$

Recall [7, 9] that in the case of the square lattice the three weights corresponding to ω are given by

$$\begin{aligned} W_{\mathcal{A}_0}(t) &= (q - \xi Q)_+ w_{\mathcal{A}_0}(t), & W_{\mathcal{B}_k}(t) &= (q_k - \xi Q)_+ w_{\mathcal{B}_k}(t), \\ W_{\mathcal{C}_k}(t) &= (q_{k+1} - \xi Q)_+ w_{\mathcal{C}_k}(t). \end{aligned} \quad (4.1)$$

They reflect the area of the parallelogram of height given respectively by $w_{\mathcal{A}_0}$, $w_{\mathcal{C}_k}$ or $w_{\mathcal{B}_k}$, and length given by the distance from ξQ to the bottom of the corresponding sub-channel (if ξQ is lesser than the total length of the sub-channel).

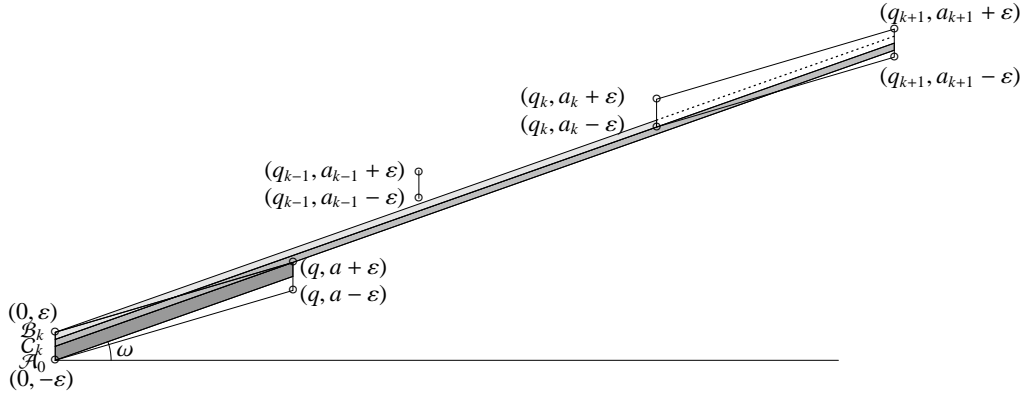

FIGURE 5. The three-strip partition of $\mathbb{R}^2/\mathbb{Z}^2$ when $t \in I_{\gamma,k}$

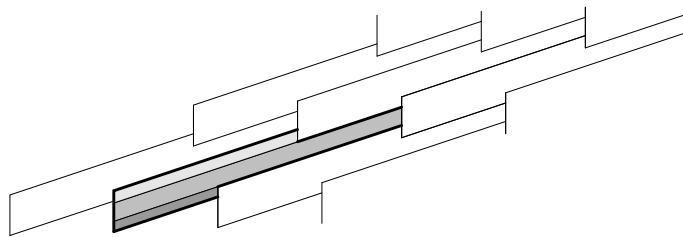

FIGURE 6. The tiling \mathfrak{S}_ω of the plane (shaded region represents $\mathbb{R}^2/\mathbb{Z}^2$)

The range for $q_k = q' + kq$, respectively q'_k , will be

$$q_k \in \mathcal{I}_{q,k} := [Q + (k-1)q, Q + kq], \quad \text{respectively} \quad q'_k \in \mathcal{I}_{q',k}.$$

Denote by $r, r_k, r', r'_k \in \mathbb{Z}/3\mathbb{Z}$ the remainders (mod 3) of $q - a, q_k - a_k, q' - a', q'_k - a'_k$ respectively. The equality $a'q - aq' = 1$ shows that at most one element of the triple $(r, r_k, r_{k+1}) \in (\mathbb{Z}/3\mathbb{Z})^3$ can be equal to zero. Similarly, at most one element of the triple (r', r'_k, r'_{k+1}) can be zero.

To ascertain the contribution of the slope $t = \tan \omega \in I_{\gamma,k}$ to $\mathbb{G}_{I,Q}(\xi)$, we should look at the tiling \mathfrak{S}_ω defined by the three-strip partition of \mathbb{R}^2 (shown in Figure 6), but also at \mathfrak{S}_ω^- , its left-horizontal translate by $(1, 0)$, and at $\mathfrak{S}_\omega^\downarrow$, its down-vertical translate by $(0, 1)$. Since the slits $(m, n) \in \mathbb{Z}^2$ with

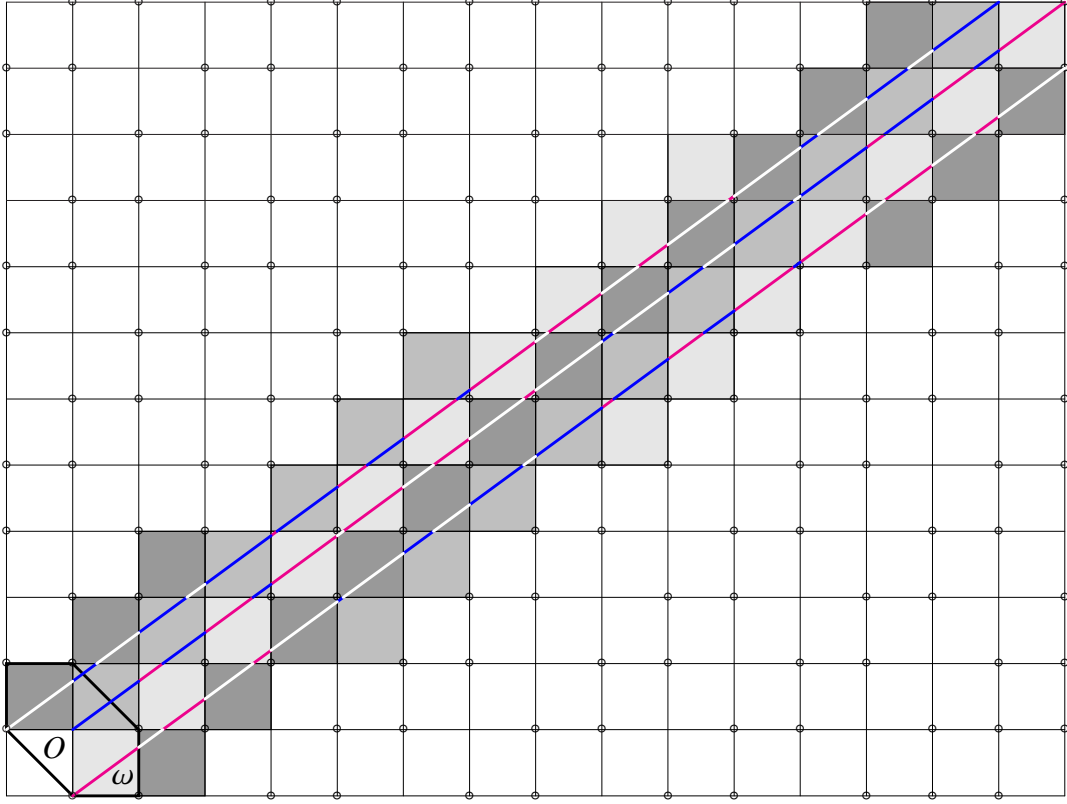
FIGURE 7. The channels C_0 , C_{\leftarrow} and C_{\downarrow}

$m \equiv n \pmod{3}$ are being removed, sinks are going to arise in the channels. This phenomenon will lead to frequent occurrence of trajectories much longer than in the case of the square lattice. A careful analysis of the bottom of the channels \mathcal{A}_0 , C_k and \mathcal{B}_k is required when the corresponding slit where trajectory ends in the case of the square lattice has been removed. Besides, there is a manifest difference between the three situations where the channel originates at $O = (0, 0)$ (this will be referred to as C_O contribution), at $(-1, 0)$ (C_{\leftarrow} contribution), or at $(-1, 0)$ (C_{\downarrow} contribution), resulting from the different congruence conditions $\pmod{3}$ satisfied by the centers of removed slits. This is shown in Figure 6 where the small circles centered at lattice points (m, n) with $m \not\equiv n \pmod{3}$ represent the vertical slits of width $2\varepsilon = \frac{1}{Q}$. We were not able to spot any symmetry that would reduce the analysis to only one of these three types of channels. The contributions to Φ^{hex} of the five types of situations that we analyze seem to be quite different (see Figure 19).

To attain a better visualization of the structure of channels we shall represent the slope $\tan \omega$ horizontally. The possible situations are shown in Figure 8, where dotted lines indicate that the corresponding slit has been removed from \mathfrak{S}_ω in the case of C_O , from $\mathfrak{S}_\omega^{\leftarrow}$ in the case of C_{\leftarrow} and respectively from $\mathfrak{S}_\omega^{\downarrow}$ in the case of C_{\downarrow} .

To clarify the terminology, by “slit q_k ” etc. we will mean the slit which is centered at some lattice point (q_k, m) and which intersects the channel that is analyzed (there is at most one such point for given q_k).

(r, r_k, r_{k+1})	C_O	C_{\leftarrow}	C_{\downarrow}
$(1, 1, -1)$			
$(-1, -1, 1)$			
$(0, 1, 1)$			
$(0, -1, -1)$			
$(1, 0, 1)$			
$(-1, 0, -1)$			
$(1, -1, 0)$			
$(-1, 1, 0)$			

 FIGURE 8. The removed slits for C_O , C_{\leftarrow} and C_{\downarrow}

5. THE CONTRIBUTION OF CHANNELS WHOSE SLITS ARE NOT REMOVED

This resembles the situation of the square lattice and will be discussed in this section. The more intricate situation of the channels where bottom slits are removed will be analyzed in Sections 6-9. When the “first” slit (i.e. the one corresponding to q for \mathcal{A}_0 , q_{k+1} for C_k , respectively q_k for \mathcal{B}_k) is not removed, the table from Figure 8 shows that the corresponding weight is described in the table from Figure 9.

The weights $W_{\mathcal{A}_0}$, $W_{\mathcal{B}_k}$ and W_{C_k} are given by (4.1) as in the case of the square lattice. The cumulative contribution is

$$\mathbb{G}_{I,Q}^{(0)}(\xi) = \sum_{(\alpha,\beta) \in (\mathbb{Z}/3\mathbb{Z})^2 \setminus \{(0,0)\}} \mathbb{G}_{I,Q,\alpha,\beta}^{(0)}(\xi),$$

with $\mathbb{G}_{I,Q,\alpha,\beta}^{(0)}(\xi)$ given by

$$\sum_{k=0}^{\infty} \sum_{\substack{\gamma \in \mathcal{F}_I(Q) \\ q-a \equiv \alpha \pmod{3} \\ q_k - a_k \equiv \beta \pmod{3}}} \int_{t_k}^{t_{k-1}} \frac{2((q - \xi Q)_+ w_{\mathcal{A}_0}(t) + (q_{k+1} - \xi Q)_+ w_{C_k}(t) + (q_k - \xi Q)_+ w_{\mathcal{B}_k}(t)) dt}{t^2 + t + 1}. \quad (5.1)$$

Remark 1.. Putting $x = q - a$, $y = q_k$, and employing $q_k - a_k = q_k - \frac{1+aq_k}{q} = \frac{xy-1}{q}$, we see that the summation conditions in (5.1) are equivalent to $(x, q) = 1$, $x \equiv \alpha \pmod{3}$, and $xy \equiv \beta q + 1 \pmod{3q}$. Note that $(\beta q + 1, q) = 1$ and sum as follows:

(r, r_k, r_{k+1})	C_O	C_{\leftarrow}	C_{\downarrow}
$(1, 1, -1)$	$W_{\mathcal{A}_0} + W_{C_k} + W_{\mathcal{B}_k}$	W_{C_k}	$W_{\mathcal{A}_0} + W_{\mathcal{B}_k}$
$(-1, -1, 1)$	$W_{\mathcal{A}_0} + W_{C_k} + W_{\mathcal{B}_k}$	$W_{\mathcal{A}_0} + W_{\mathcal{B}_k}$	W_{C_k}
$(0, 1, 1)$	$W_{C_k} + W_{\mathcal{B}_k}$	$W_{\mathcal{A}_0}$	$W_{\mathcal{A}_0} + W_{C_k} + W_{\mathcal{B}_k}$
$(0, -1, -1)$	$W_{C_k} + W_{\mathcal{B}_k}$	$W_{\mathcal{A}_0} + W_{C_k} + W_{\mathcal{B}_k}$	$W_{\mathcal{A}_0}$
$(1, 0, 1)$	$W_{\mathcal{A}_0} + W_{C_k}$	$W_{\mathcal{B}_k}$	$W_{\mathcal{A}_0} + W_{C_k} + W_{\mathcal{B}_k}$
$(-1, 0, -1)$	$W_{\mathcal{A}_0} + W_{C_k}$	$W_{\mathcal{A}_0} + W_{C_k} + W_{\mathcal{B}_k}$	$W_{\mathcal{B}_k}$
$(1, -1, 0)$	$W_{\mathcal{A}_0} + W_{\mathcal{B}_k}$	$W_{C_k} + W_{\mathcal{B}_k}$	$W_{\mathcal{A}_0} + W_{C_k}$
$(-1, 1, 0)$	$W_{\mathcal{A}_0} + W_{\mathcal{B}_k}$	$W_{\mathcal{A}_0} + W_{C_k}$	$W_{C_k} + W_{\mathcal{B}_k}$

FIGURE 9. The contribution of channels whose slits are not removed

- When $\alpha \neq 0$ Lemma 8 may be applied (because $(x, 3q) = 1$), followed by Lemma 3.
- When $\alpha = 0$ we have $\beta \neq 0$ and $x = 3\tilde{x}$, $\tilde{x} \in \frac{q}{3}(1 - I)$. Furthermore, $\beta q + 1 \equiv 0 \pmod{3}$, so $q \equiv -\beta \pmod{3}$ and one may first sum, as in Lemma 4, over (\tilde{x}, y) and the conditions

$$\begin{cases} q - a = x = 3\tilde{x}, & \tilde{x} \in \frac{q}{3}(1 - I), & (\tilde{x}, q) = 1, \\ q \equiv -\beta \pmod{3}, & \tilde{x}y \equiv \frac{\beta q + 1}{3} \pmod{q}, & y \in \mathcal{I}_{q,k}, \end{cases} \quad (5.2)$$

and then sum over $q \in [1, Q]$ with $q \equiv -\beta \pmod{3}$ employing Lemma 3.

In all situations where sums over $\gamma \in \mathcal{F}_I(Q)$ with $q - a \equiv \alpha \pmod{3}$ and $q_k - a_k \equiv \beta \pmod{3}$, $(\alpha, \beta) \neq (0, 0)$, have to be evaluated, the resulting constant will be $\frac{1}{8\zeta(2)}$.

The following elementary estimate will be used throughout.

Lemma 9. For $b, c, h, \lambda, \mu \in \mathbb{R}$ such that $0 \leq b, c, c + h \leq 1$ and $\lambda c + \mu = 0$, there exist $\theta', \theta = \theta_{c,h} \in [-3, 3]$ such that

$$\int_c^{c+h} \frac{\lambda t + \mu}{t^2 + t + 1} du = \frac{h^2 \lambda}{2(b^2 + b + 1)} + h^3 \theta (|\lambda| + |\mu|) + h^2 \theta' |b - c| |\lambda|.$$

Proof. This follows immediately applying Taylor's formula twice:

$$\begin{aligned} \int_c^{c+h} \frac{dt}{t^2 + t + 1} &= \frac{h}{c^2 + c + 1} - \frac{h^2(2c + 1)}{2(c^2 + c + 1)^2} + \xi' h^3, & |\xi'| \leq 1, \\ \int_c^{c+h} \frac{t dt}{t^2 + t + 1} &= \left(\frac{h}{c^2 + c + 1} - \frac{h^2(2c + 1)}{2(c^2 + c + 1)^2} \right) c + \frac{h^2}{2(c^2 + c + 1)} + \xi'' h^3, & |\xi''| \leq 2, \end{aligned}$$

and employing

$$\left| \frac{1}{c^2 + c + 1} - \frac{1}{b^2 + b + 1} \right| \leq 3|b - c|.$$

□

Together with $0 < q_1 - Q \leq q \wedge q'$ Lemma 9 yields $(t_{-1} = \gamma_1)$

$$\int_{t_0}^{t_{-1}} \frac{w_{\mathcal{B}_0}(t) dt}{t^2 + t + 1} = \int_{t_0}^{\gamma_1} \frac{q't - a' + 2\varepsilon}{t^2 + t + 1} dt = \frac{(q_1 - Q)^2}{2Q^2 q' q_1^2 (\gamma^2 + \gamma + 1)} + O\left(\frac{1}{Q^5}\right). \quad (5.3)$$

$$\begin{aligned}
\int_{t_0}^{t-1} \frac{w_{C_0}(t) dt}{t^2 + t + 1} &= \int_{\gamma}^{\gamma_1} \frac{qt - a}{t^2 + t + 1} dt - \int_{\gamma}^{t_0} \frac{qt - a}{t^2 + t + 1} dt - \int_{t_0}^{\gamma_1} \frac{q't - a' + 2\varepsilon}{t^2 + t + 1} dt \\
&= q \frac{(\gamma_1 - \gamma)^2 - (t_0 - \gamma)^2}{2(\gamma^2 + \gamma + 1)} - q' \frac{(\gamma_1 - t_0)^2}{2(\gamma^2 + \gamma + 1)} \\
&\quad + O\left(q(\gamma_1 - \gamma)^3 + q'(\gamma_1 - t_0)^3 + q'(\gamma_1 - t_0)^2(t_0 - \gamma)\right) \\
&= \frac{q_1 - Q}{2Q^2 q' q_1 (\gamma^2 + \gamma + 1)} \left(\frac{2Q - q_1}{q_1} + \frac{Q - q}{q'} \right) + O\left(\frac{1}{Q^3 q^2}\right).
\end{aligned} \tag{5.4}$$

$$\begin{aligned}
\int_{t_0}^{t-1} \frac{w_{A_0}(t) dt}{t^2 + t + 1} &= \int_{t_0}^{u_0} \frac{a + 2\varepsilon - qt}{t^2 + t + 1} dt - \int_{\gamma_1}^{u_0} \frac{a + 2\varepsilon - qt}{t^2 + t + 1} dt \\
&= q \frac{(u_0 - t_0)^2 - (u_0 - \gamma_1)^2}{2(\gamma^2 + \gamma + 1)} + O\left(q(u_0 - t_0)^3 + q(u_0 - t_0)^2(u_0 - \gamma)\right) \\
&= \frac{(q_1 - Q)^2 (q_1 + q')}{2Q^2 q'^2 q_1^2 (\gamma^2 + \gamma + 1)} + O\left(\frac{1}{Q^3 q q'}\right).
\end{aligned} \tag{5.5}$$

For every $k \geq 1$ we find

$$\int_{t_k}^{t_{k-1}} \frac{w_{B_k}(t) dt}{t^2 + t + 1} = \int_{t_k}^{t_{k-1}} \frac{q_k t - a_k + 2\varepsilon}{t^2 + t + 1} dt = \frac{(Q - q)^2}{2Q^2 q_{k-1}^2 q_k (\gamma^2 + \gamma + 1)} + O\left(\frac{1}{qq_{k-1}^2 q_k^2}\right). \tag{5.6}$$

$$\begin{aligned}
\int_{t_k}^{t_{k-1}} \frac{w_{C_k}(t) dt}{t^2 + t + 1} &= \int_{t_k}^{t_{k-1}} \frac{a_{k-1} - 2\varepsilon - q_{k-1} t}{t^2 + t + 1} dt \\
&= \frac{(Q - q)^2}{2Q^2 q_{k-1} q_k^2 (\gamma^2 + \gamma + 1)} + O\left(\frac{1}{qq_{k-1}^2 q_k^2}\right).
\end{aligned} \tag{5.7}$$

$$\begin{aligned}
\int_{t_k}^{t_{k-1}} \frac{2\varepsilon dt}{t^2 + t + 1} &= \frac{t_{k-1} - t_k}{Q(\gamma^2 + \gamma + 1)} + O\left(\varepsilon(t_{k-1} - t_k)(t_k - \gamma) + \varepsilon(t_{k-1} - t_k)^2\right) \\
&= \frac{Q - q}{Q^2 q_{k-1} q_k (\gamma^2 + \gamma + 1)} + O\left(\frac{1}{Qqq_{k-1} q_k^2}\right).
\end{aligned} \tag{5.8}$$

$$\begin{aligned}
\int_{t_k}^{t_{k-1}} \frac{w_{A_0}(t) dt}{t^2 + t + 1} &= \int_{t_k}^{t_{k-1}} \frac{2\varepsilon - w_{B_k}(t) - w_{C_k}(t)}{t^2 + t + 1} dt \\
&= \frac{Q - q}{2Q^2 q_{k-1} q_k (\gamma^2 + \gamma + 1)} \left(\frac{q_{k+1} - Q}{q_k} + \frac{q_k - Q}{q_{k-1}} \right) + O\left(\frac{1}{qq' q_{k-1} q_k^2}\right).
\end{aligned} \tag{5.9}$$

The total contribution of the error terms from (5.3)-(5.7) and (5.9) to $\mathbb{G}_{I,Q}^{(0)}(\xi)$ is

$$\begin{aligned}
&\ll \sum_{\gamma \in \mathcal{F}_I(Q)} \frac{1}{(qq')^2} + \sum_{k=1}^{\infty} \sum_{\gamma \in \mathcal{F}_I(Q)} \left(\frac{1}{q' q_{k-1} q_k^2} + \frac{1}{qq_{k-1}^2 q_k} \right) \leq \sum_{\gamma \in \mathcal{F}_I(Q)} \frac{1}{(qq')^2} + \sum_{\gamma \in \mathcal{F}_I(Q)} \frac{1}{qq'} \sum_{k=1}^{\infty} \frac{1}{q_{k-1} q_k} \\
&= 2 \sum_{\gamma \in \mathcal{F}_I(Q)} \frac{1}{(qq')^2} \leq \frac{2}{Q} \sum_{\gamma \in \mathcal{F}_I(Q)} \frac{1}{qq'} \leq \frac{2}{Q} \left(|I| + \frac{2}{Q} \right) \leq \frac{6|I|}{Q}.
\end{aligned}$$

When summing over a family of intervals I that partition $[0, 1]$ this adds up to $O(Q^{-1})$, thus all error terms above can be discarded below. We emphasize that, since the contribution of each interval $I_{\gamma,k}$ is $\leq |I_{\gamma,k}|$, we can remove one element of $\mathcal{F}_I(Q)$ for every I .

Applying Remark 1 to the inner sum in (5.1) with $x = q - a \in q(1 - I)$, $y = q_k \in \mathcal{I}_{q,k}$, and employing formulas (5.3)-(5.9) we find

$$\mathbb{G}_{I,Q,\alpha,\beta}^{(0)}(\xi) = \sum_{q=1}^Q \sum_{k=1}^{\infty} \sum_{\substack{x \in q(1-I), y \in \mathcal{I}_{q,k} \\ x \equiv \alpha \pmod{3} \\ xy \equiv \beta q + 1 \pmod{3q}}} f_q(x, y) + \sum_{q=1}^Q \sum_{\substack{x \in q(1-I), y \in (Q-q, Q] \\ x \equiv \alpha \pmod{3} \\ xy \equiv \beta q + 1 \pmod{3q}}} g_q(x, y), \quad (5.10)$$

with C^1 functions f_q and g_q on $\mathbb{R} \times (\mathbb{R}_+ \setminus \{q, \xi Q - q, \xi Q\})$ given by

$$\begin{aligned} f_q(x, y) &= \frac{q^2}{q^2 + (q - x)^2} F_q(y), & g_q(x, y) &= \frac{q^2}{q^2 + (q - a)^2} G_q(y), \\ F_q(y) &= \frac{Q - q}{Q^2(y - q)y} \left(\frac{y + q - Q}{y} + \frac{y - Q}{y - q} \right) (q - \xi Q)_+ \\ &\quad + \frac{(Q - q)^2}{Q^2(y - q)y} \left(\frac{(y - \xi Q)_+}{y - q} + \frac{(y + q - \xi Q)_+}{y} \right), \\ G_q(y) &= \frac{y + q - Q}{Q^2 y(y + q)} \left(\frac{2Q - q - y}{y + q} + \frac{Q - q}{y} \right) (y + q - \xi Q)_+ \\ &\quad + \frac{(y + q - Q)^2}{Q^2 y(y + q)^2} \left(\frac{2y + q}{y} (q - \xi Q)_+ + (y - \xi Q)_+ \right). \end{aligned}$$

The innermost sums in (5.10) will be estimated employing Lemmas 4 or 8. We first need to bound $\|f_q\|_{\infty}$, $\|\nabla f_q\|_{\infty}$ on $q(1 - I) \times \mathcal{I}_{q,k}$, $k \geq 1$, and respectively $\|g_q\|_{\infty}$, $\|\nabla g_q\|_{\infty}$ on $q(1 - I) \times (Q - q, Q]$. From $y \geq Q$ in the first case and $y + q - Q \leq Q \leq Q \leq y + q \leq 2Q$ in the second one we find for all $y \in \mathcal{I}_{q,k}$, $k \geq 1$:

$$0 \leq f_q(x, y) \leq F_q(y) \leq \frac{Q - q}{Q^2(y - q)y} \left(q + (Q - q) \left(2 + \frac{q}{y - q} + \frac{q}{y} \right) \right) \leq \frac{4(Q - q)}{Q(y - q)y}, \quad (5.11)$$

$$|F'_q(y)| \leq \frac{16(\xi + 1)(Q - q)}{Q(y - q)^2 y}, \quad (5.12)$$

and for all $y \in (Q - q, Q]$:

$$0 \leq g_q(x, y) \leq G_q(y) \leq \frac{1}{Q^2(y + q)} \cdot 2(y + q) + \frac{1}{Q^2(y + q)^2} \cdot ((2y + q)q + y^2) = \frac{3}{Q^2}, \quad (5.13)$$

$$|G'_q(y)| \leq \frac{20}{Qy^2}. \quad (5.14)$$

From (5.11) we infer

$$\sum_{k=1}^{\infty} \|F_q\|_{\mathcal{I}_{q,k}} \leq \frac{2(Q - q)}{Q} \sum_{k=1}^{\infty} \frac{1}{(Q + (k - 2)q)(Q + (k - 1)q)} = \frac{4}{Qq},$$

which leads in turn to

$$\sum_{q=1}^Q q^{\frac{1}{2} + \delta} \sum_{k=1}^{\infty} \|f_q\|_{q(1-I) \times \mathcal{I}_{q,k}} \leq \frac{2}{Q} \sum_{q=1}^Q q^{-\frac{1}{2} + \delta} \leq 8Q^{\frac{1}{2} + \delta}.$$

From (5.12) we infer

$$\begin{aligned} \sum_{k=1}^{\infty} \|F'_q\|_{I_{q,k}} &\leq \frac{16(\xi+1)(Q-q)}{Q} \sum_{k=1}^{\infty} \frac{1}{(Q+(k-2)q+1)^2(Q+(k-1)q+1)} \\ &\leq \frac{16(\xi+1)}{Q} \sum_{k=1}^{\infty} \frac{1}{(Q+(k-2)q+1)(Q+(k-1)q+1)} \leq \frac{16(\xi+1)}{Qq(Q-q+1)}, \end{aligned}$$

which leads to

$$\sum_{k=1}^{\infty} \|\nabla f_q\|_{q(1-I) \times I_{q,k}} \leq \sum_{k=1}^{\infty} \left(\frac{2}{q} \|F_q\|_{I_{q,k}} + \|F'_q\|_{I_{q,k}} \right) \leq \frac{24(\xi+1)}{q^2(Q-q+1)},$$

and finally gives

$$\begin{aligned} \sum_{q=1}^Q q^{\frac{3}{2}+\delta} \sum_{k=1}^{\infty} \|\nabla f_q\|_{q(1-I) \times I_{q,k}} &\ll_{\xi} \sum_{1 \leq q \leq \frac{Q}{2}} \frac{q^{-1/2+\delta}}{Q-q+1} + \sum_{\frac{Q}{2} \leq q \leq Q} \frac{q^{-1/2+\delta}}{Q-q+1} \\ &\leq \frac{2}{Q} \sum_{q=1}^Q q^{-\frac{1}{2}+\delta} + \left(\frac{Q}{2}\right)^{-\frac{1}{2}+\delta} \sum_{n=1}^Q \frac{1}{n} \ll Q^{-\frac{1}{2}+\delta} \log Q, \end{aligned} \quad (5.15)$$

$$\sum_{q=1}^Q q^2 \sum_{k=1}^{\infty} \|\nabla f_q\|_{q(1-I) \times I_{q,k}} \ll_{\xi} \sum_{q=1}^Q \frac{1}{Q-q+1} \ll \log Q. \quad (5.16)$$

Taking $T = [Q^c]$ we infer upon (5.15) and (5.16), with $E_{c,c',\delta}(Q)$ as in Theorem 2,

$$\begin{aligned} \sum_{q=1}^Q \sum_{k=1}^{\infty} \left(Tq^{\frac{1}{2}+\delta} (T\|f_q\|_{q(1-I) \times I_{q,k}} + q\|\nabla f_q\|_{q(1-I) \times I_{q,k}}) + \frac{q|I|_{I_{q,k}|}}{T} \|\nabla f_q\|_{q(1-I) \times I_{q,k}} \right) \\ \ll_{\xi,\delta} T^2 Q^{-\frac{1}{2}+\delta} + TQ^{-\frac{1}{2}+\delta} \log Q + |I|T^{-1} \log Q \ll E_{c,c',\delta}(Q), \end{aligned} \quad (5.17)$$

uniformly for ξ in compact subsets of $[0, \infty)$. From (5.13) and (5.14) we also get

$$\sum_{q=1}^Q \left(Tq^{\frac{1}{2}+\delta} (T\|g_q\|_{q(1-I) \times I_{q,0}} + q\|\nabla g_q\|_{q(1-I) \times I_{q,0}}) + \frac{q^2|I|}{T} \|\nabla g_q\|_{q(1-I) \times I_{q,0}} \right) \ll_{\delta} E_{c,c',\delta}(Q). \quad (5.18)$$

When $\alpha \neq 0$, Lemma 8 applies to the innermost sums in (5.10). Upon (5.17) and (5.18) we find

$$\begin{aligned} \mathbb{G}_{I,Q,\alpha,\beta}^{(0)}(\xi) &\cong \sum_{\substack{1 \leq q \leq Q \\ 3 \nmid q}} \frac{\varphi(q)}{9q^2} \cdot qc_I \left(\sum_{k=1}^{\infty} \int_{I_{q,k}} F_q(y) dy + \int_{Q-q}^Q G_q(y) dy \right) \\ &\cong \sum_{\substack{1 \leq q \leq Q \\ 3 \nmid q}} \frac{\varphi(q)}{6q^2} \cdot qc_I \left(\sum_{k=1}^{\infty} \int_{I_{q,k}} F_q(y) dy + \int_{Q-q}^Q G_q(y) dy \right). \end{aligned} \quad (5.19)$$

Applying Lemma 3 with $\ell = 3$ to the sum over q in (5.19) and making the substitution $(q, y) = (Qu, Qw)$ we gather

$$\mathbb{G}_{I,Q,\alpha,\beta}^{(0)}(\xi) \cong \left(\frac{3}{4} \cdot \frac{1}{9} + \frac{1}{4} \cdot \frac{1}{6} \right) \frac{c_I}{\zeta(2)} \cdot \int_0^1 du \left(\int_{1-u}^1 dw F^{(0.1)}(\xi; u, w) + \int_1^{\infty} dw F^{(0.2)}(\xi; u, w) \right),$$

with $F^{(0.1)}$ and $F^{(0.2)}$ as in (5.22). The total contribution of cases $\alpha \neq 0$ to $\mathbb{G}_{I,Q}^{(0)}(\xi)$ is obtained by multiplying the quantity above by 6.

When $\alpha = 0$ and $\beta = \pm 1$ we sum as above, with summation conditions in the inner sum given by (5.2) and get, employing Lemmas 8 and 2,

$$\begin{aligned} \mathbb{G}_{I,Q,0,1}^{(0)}(\xi) + \mathbb{G}_{I,Q,0,-1}^{(0)}(\xi) &\cong \sum_{\substack{1 \leq q \leq Q \\ (q,3)=1}} \frac{\varphi(q)}{q^2} \cdot \frac{qc_I}{3} \left(\int_Q^\infty F_q(y) dy + \int_{Q-q}^Q G_q(y) dy \right) \\ &\cong \frac{c_I}{4\xi(2)} \int_0^1 du \left(\int_{1-u}^1 dw F^{(0.1)}(\xi; u, w) + \int_1^\infty dw F^{(0.2)}(\xi; u, w) \right). \end{aligned} \quad (5.20)$$

Applying Lemma 2 to (5.20) we finally find

$$\mathbb{G}_{I,Q}^{(0)}(\xi) \cong \frac{c_I}{\xi(2)} \int_0^1 du \left(\int_{1-u}^1 dw F^{(0.1)}(\xi; u, w) + \int_1^\infty dw F^{(0.2)}(\xi; u, w) \right), \quad (5.21)$$

where

$$\begin{aligned} F^{(0.1)}(\xi; u, w) &= \frac{(w+u-1)^2(2w+u)}{w^2(w+u)^2} (u-\xi)_+ + \frac{(w+u-1)^2}{w(w+u)^2} (w-\xi)_+ \\ &\quad + \frac{w+u-1}{w(w+u)} \left(\frac{2-u-w}{w+u} + \frac{1-u}{w} \right) (w+u-\xi)_+, \\ F^{(0.2)}(\xi; u, w) &= \frac{1-u}{(w-u)w} \left(\frac{w+u-1}{w} + \frac{w-1}{w-u} \right) (u-\xi)_+ \\ &\quad + \frac{(1-u)^2}{(w-u)^2 w} (w-\xi)_+ + \frac{(1-u)^2}{(w-u)w^2} (w+u-\xi)_+. \end{aligned} \quad (5.22)$$

Remark 2.. For each angle ω the weight $W_{\gamma,k}(t) = W_{\gamma,k}^{\text{hex}}(t)$ is clearly no larger than the weight $W_{\gamma,k}^\square(t)$ from the situation where no slit is being removed (and which corresponds up to some scaling to the case of the the unit square).⁴ Since the corresponding limiting distribution Φ^\square satisfies (1.2) [8, 7, 11], it follows that Φ^{hex} satisfies the second inequality in (1.2). The first inequality in (1.2) follows for instance from

$$G^{(0)}(\xi) := \int_0^1 du \int_1^\infty dw \frac{(1-u)^2}{(w-u)^2 w} (w-\xi)_+ \geq \int_0^1 du (1-u)^2 \int_\xi^\infty \frac{v dv}{(v+\xi)^3} = \frac{3}{16\xi}.$$

6. CHANNELS WITH REMOVED SLITS. THE CASE $r = r_k = \pm 1$

Assume first that $r = r_k = 1$. Then $r_{k+1} = r + r_k = -1 \pmod{3}$. One has to analyze the C_\leftarrow and the C_\downarrow contributions. We shall sum as in Remark 1 above with $x = q - a \in q(1 - I)$, $\alpha = 1$, $y = q_k \in \mathcal{I}_{q,k}$, $\beta = 1$, considering

$$\sum^* = \sum_{\substack{\gamma \in \mathcal{F}_I(Q) \\ q-a \equiv 1 \pmod{3} \\ q_k - a_k \equiv 1 \pmod{3}}}^* .$$

The table in Figure 8 shows that the weights $W_{\gamma,k}(t)$ for $(C_\leftarrow, r = r_k = 1)$ and for $(C_\downarrow, r = r_k = -1)$ do coincide, and so they do for $(C_\downarrow, r = r_k = 1)$ and $(C_\leftarrow, r = r_k = -1)$. This eventually shows that

⁴Note that because of the scaling of ξ this does not imply $\Phi^{\text{hex}}(\xi) \leq \Phi^\square(\xi)$ (see also Figure 2).

the corresponding contribution for $r = r_k = -1$ has the same main term and error terms as the one for $r = r_k = 1$ (we just need to replace β by $-\beta$ and α by $-\alpha$, which will produce the same main term and error size). As a result we shall only take $r = r_k = 1$ and double the total contribution in the sequel.

6.1. The C_{\leftarrow} contribution. The slits q and q_k are removed, while $2q$, q_{k+1} , q_{k+2} , $2q_k$ and $q_k + q_{k+1}$ are not because $2r = r_{k+1} = 2r_k = 2$, $r_{k+2} = r_k + r_{k+1} = 0 \not\equiv 1 \pmod{3}$. Denote by $T(\bullet)$, respectively $B(\bullet)$, the height of the top, respectively bottom, of the slit \bullet with respect to the top of the strip \mathcal{B}_k , with positive downwards direction. Since $B(q_{k+1}) = 2w_{\mathcal{B}_k} + w_{C_k} < T(2q) = 2(w_{\mathcal{B}_k} + w_{C_k}) < B(q_{k+2}) = 3w_{\mathcal{B}_k} + 2w_{C_k}$ and $B(2q_k) = w_{\mathcal{B}_k} - w_{\mathcal{A}_0} - w_{C_k} < T(q_{k+1} + q_k) = w_{\mathcal{B}_k} - w_{\mathcal{A}_0}$, the slits $2q$, q_{k+2} , q_{k+1} , $q_{k+1} + q_k$ and $2q_k$ lock all channels \mathcal{B}_k , C_k and \mathcal{A}_0 . Two cases arise:

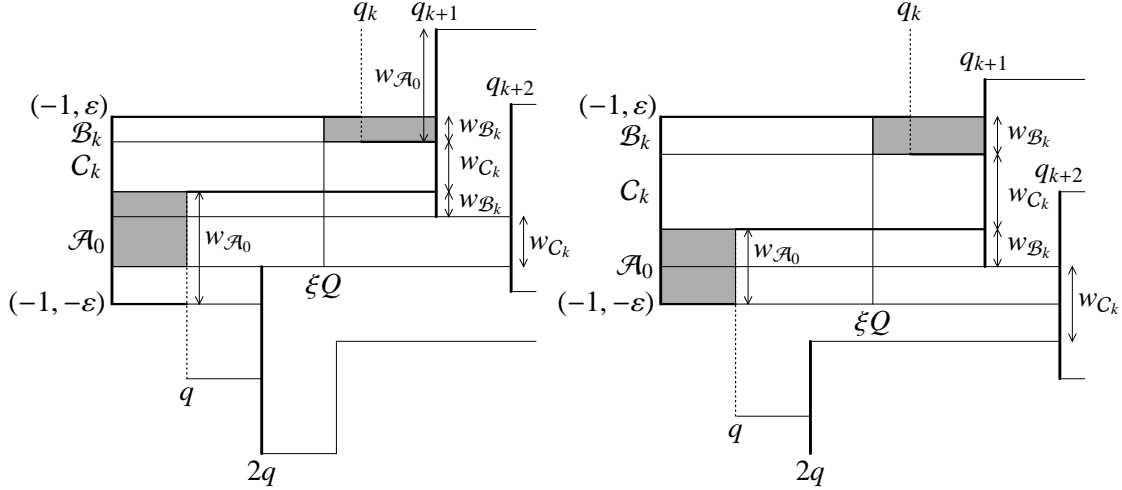

FIGURE 10. The case $t \in I_{\gamma,k}$, (C_{\leftarrow} , $r = r_k = 1$), and $w_{\mathcal{B}_k} + w_{C_k} < w_{\mathcal{A}_0}$ respectively $w_{\mathcal{B}_k} + w_{C_k} > w_{\mathcal{A}_0}$

6.1.1. $w_{\mathcal{B}_k} < w_{\mathcal{A}_0}$ ($\iff t = \tan \omega < \gamma_{k+1}$). In this case \mathcal{B}_k is locked by the slit q_{k+1} while \mathcal{A}_0 is locked by the slits q_{k+1} , q_{k+2} and $2q$. Two subcases arise:

(I) $w_{\mathcal{B}_k} + w_{C_k} < w_{\mathcal{A}_0}$ ($\iff t < \frac{a+\varepsilon}{q}$). Then $B(q_{k+1}) < T(2q) < 2\varepsilon$, so \mathcal{A}_0 is locked by the slits q_{k+1} , q_{k+2} and $2q$ (see left-hand side of Figure 10). The widths of the relevant three sub-channels of \mathcal{A}_0 are (from bottom to top) $2\varepsilon - T(2q) = 2(a + \varepsilon - qt)$, w_{C_k} and $w_{\mathcal{B}_k}$, so⁵

$$W_{\gamma,k}(t) = W_{\gamma,k}^{(1)}(t) = 2(a + \varepsilon - qt) \cdot (2q - \xi Q)_+ \wedge q + w_{C_k}(t) \cdot (q_{k+2} - \xi Q)_+ \wedge q + w_{\mathcal{B}_k}(t) \cdot (q_{k+1} - \xi Q)_+ \wedge q + w_{\mathcal{B}_k}(t) \cdot (q_{k+1} - \xi Q)_+ \wedge q_k. \quad (6.1)$$

(II) $w_{\mathcal{B}_k} < w_{\mathcal{A}_0} < w_{\mathcal{B}_k} + w_{C_k}$ ($\iff t > \frac{a+\varepsilon}{q}$). Then $B(q_{k+1}) = 2w_{\mathcal{B}_k} + w_{C_k} < 2\varepsilon < T(2q) = 2w_{\mathcal{B}_k} + 2w_{C_k}$, so \mathcal{A}_0 is locked by the slits q_{k+1} and q_{k+2} (see right-hand side of Figure 10). The widths of the relevant two sub-channels of \mathcal{A}_0 are (from bottom to top) $2\varepsilon - B(q_{k+1}) = a_{k+1} - q_{k+1}t$ and $w_{\mathcal{B}_k}$, hence in this case

$$W_{\gamma,k}(t) = W_{\gamma,k}^{(2)}(t) = (a_{k+1} - q_{k+1}t) \cdot (q_{k+2} - \xi Q)_+ \wedge q + w_{\mathcal{B}_k}(t) \cdot (q_{k+1} - \xi Q)_+ \wedge q + w_{\mathcal{B}_k}(t) \cdot (q_{k+1} - \xi Q)_+ \wedge q_k. \quad (6.2)$$

⁵Only \mathcal{A}_0 and \mathcal{B}_k have to be taken into account here because C_k has been already considered in the previous section.

6.1.2. $w_{\mathcal{A}_0} < w_{\mathcal{B}_k}$ ($\iff t > \gamma_{k+1}$). In this case \mathcal{A}_0 is locked by the slits q_{k+1} and \mathcal{B}_k by q_{k+1} , $q_{k+1} + q_k$ and $2q_k$. Two subcases arise:

(III) $w_{\mathcal{A}_0} < w_{\mathcal{B}_k} < w_{\mathcal{A}_0} + w_{C_k}$ ($\iff \gamma_{k+1} < t < \frac{a_k - \varepsilon}{q_k}$). Then $B(2q_k) < 0 < T(q_{k+1})$, so \mathcal{B}_k is locked by the slits q_{k+1} and $q_{k+1} + q_k$. The widths of the relevant two sub-channels of \mathcal{B}_k are $w_{\mathcal{A}_0}$ and $T(q_{k+1}) = q_{k+1}t - a_{k+1}$, hence in this case

$$W_{\gamma,k}(t) = W_{\gamma,k}^{(3)}(t) = w_{\mathcal{A}_0}(t) \cdot (q_{k+1} - \xi Q)_+ \wedge q + w_{\mathcal{A}_0}(t) \cdot (q_{k+1} - \xi Q)_+ \wedge q_k \\ + (q_{k+1}t - a_{k+1}) \cdot (q_{k+1} + q_k - \xi Q)_+ \wedge q_k. \quad (6.3)$$

(IV) $w_{\mathcal{A}_0} + w_{C_k} < w_{\mathcal{B}_k}$ ($\iff \frac{a_k - \varepsilon}{q_k} < t$). Then $0 < B(2q_k) < T(q_{k+1})$, so \mathcal{B}_k is locked by the slits q_{k+1} , $q_{k+1} + q_k$ and $2q_k$. The widths of the relevant three sub-channels of \mathcal{B}_k are $w_{\mathcal{A}_0}$, $T(q_{k+1}) - B(2q_k) = w_{C_k}$ and $B(2q_k) = 2(q_k t - a_k + \varepsilon)$, showing that in this case

$$W_{\gamma,k}(t) = W_{\gamma,k}^{(4)}(t) = w_{\mathcal{A}_0}(t) \cdot (q_{k+1} - \xi Q)_+ \wedge q + w_{\mathcal{A}_0}(t) \cdot (q_{k+1} - \xi Q)_+ \wedge q_k \\ + w_{C_k}(t) \cdot (q_{k+1} + q_k - \xi Q)_+ \wedge q_k + 2(q_k t - a_k + \varepsilon) \cdot (2q_k - \xi Q)_+ \wedge q_k. \quad (6.4)$$

6.2. **The C_\downarrow contribution.** Since $r = 1, r_k = 1, r_k + r_{k+1} = r + r_{k+1} = 0 \not\equiv 1 \pmod{3}$, none of the corresponding slits is being removed. Moreover $2r_{k+1} = 1 \not\equiv 0 \pmod{3}$, thus the slit $2q_{k+1}$ is not removed either and the slits $q_{k+2} = q + q_{k+1}$, $q_k + q_{k+1}$ and $2q_{k+1}$ lock the central channel (see Figure 11). Furthermore, ordering $w_{\mathcal{B}_k}$, $B(q_k + q_{k+1}) = 2w_{\mathcal{B}_k} - w_{\mathcal{A}_0}$, $w_{\mathcal{B}_k} + w_{C_k}$ and $T(q_{k+2}) = 2w_{\mathcal{B}_k} + w_{C_k} - w_{\mathcal{A}_0}$ we find as in Subsection 6.1 that the corresponding weight $W_{\gamma,k}(t)$ is given by⁶

$$\begin{cases} (w_{\mathcal{B}_k} - w_{\mathcal{A}_0})(q_k + q_{k+1} - \xi Q)_+ \wedge q_{k+1} \\ + (w_{\mathcal{A}_0} + w_{C_k} - w_{\mathcal{B}_k})(2q_{k+1} - \xi Q)_+ \wedge q_{k+1} & \text{if } w_{\mathcal{A}_0} < w_{\mathcal{B}_k} < w_{\mathcal{A}_0} + w_{C_k}, \\ w_{C_k}(q_k + q_{k+1} - \xi Q)_+ \wedge q_{k+1} & \text{if } w_{\mathcal{A}_0} + w_{C_k} < w_{\mathcal{B}_k}, \\ (w_{\mathcal{A}_0} - w_{\mathcal{B}_k})(q_{k+2} - \xi Q)_+ \wedge q_{k+1} \\ + (w_{\mathcal{B}_k} + w_{C_k} - w_{\mathcal{A}_0})(2q_{k+1} - \xi Q)_+ \wedge q_{k+1} & \text{if } w_{\mathcal{B}_k} < w_{\mathcal{A}_0} < w_{\mathcal{B}_k} + w_{C_k}, \\ w_{C_k}(q_{k+2} - \xi Q)_+ \wedge q_{k+1} & \text{if } w_{\mathcal{B}_k} + w_{C_k} < w_{\mathcal{A}_0}, \end{cases} \quad (6.5)$$

$$= \begin{cases} W_{\gamma,k}^{(5)}(t) := w_{C_k}(t) \cdot (q_{k+2} - \xi Q)_+ \wedge q_{k+1} & \text{if } t < \frac{a+\varepsilon}{q} \wedge \gamma_{k+1}, \\ W_{\gamma,k}^{(6)}(t) := (a_{k+1} - q_{k+1}t) \cdot (q_{k+2} - \xi Q)_+ \wedge q_{k+1} \\ + 2(qt - a - \varepsilon) \cdot (2q_{k+1} - \xi Q)_+ \wedge q_{k+1} & \text{if } \frac{a+\varepsilon}{q} < t < \gamma_{k+1}, \\ W_{\gamma,k}^{(7)}(t) := (q_{k+1}t - a_{k+1}) \cdot (q_k + q_{k+1} - \xi Q)_+ \wedge q_{k+1} \\ + 2(a_k - \varepsilon - q_k t) \cdot (2q_{k+1} - \xi Q)_+ \wedge q_{k+1} & \text{if } \gamma_{k+1} < t < \frac{a_k - \varepsilon}{q_k}, \\ W_{\gamma,k}^{(8)}(t) := w_{C_k}(t) \cdot (q_k + q_{k+1} - \xi Q)_+ \wedge q_{k+1} & \text{if } \frac{a_k - \varepsilon}{q_k} \vee \gamma_{k+1} < t. \end{cases}$$

6.3. Estimating the total contribution.

⁶Only the contribution of C_k needs to be taken into account here.

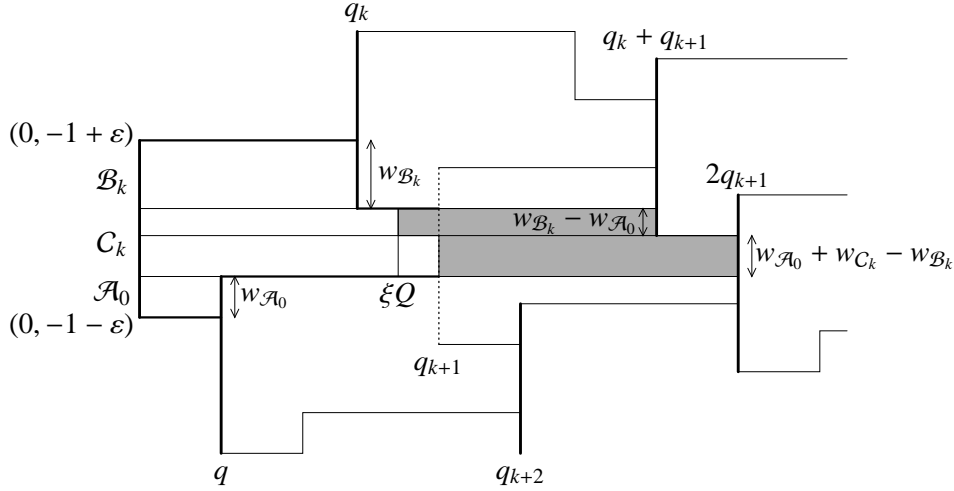
 FIGURE 11. The case $t \in I_{\gamma,k}$, $(C_{\downarrow}, r = r_k = 1)$, $w_{\mathcal{A}_0} < w_{\mathcal{B}_k} < w_{\mathcal{A}_0} + w_{\mathcal{C}_k}$

6.3.1. $q_{k+1} > 2Q$. In this case $k \geq 1$ and $t_{k-1} < \frac{a_k - \epsilon}{q_k} < \gamma_{k+1} < \frac{a + \epsilon}{q}$. The cumulative contribution of C_{\leftarrow} and C_{\downarrow} when $r = r_k = 1$ or $r = r_k = -1$ and arising from (6.1)-(6.5) is

$$\mathbb{G}_{I,Q}^{(1.1)}(\xi) = 2 \sum_{k=1}^{\infty} \sum_{\substack{q_k \in \mathcal{I}_{q,k} \\ q_{k+1} > 2Q}}^* \int_{t_k}^{t_{k-1}} \frac{W_{\gamma,k}^{(1)}(t) + W_{\gamma,k}^{(5)}(t)}{t^2 + t + 1} dt = \mathbb{G}_{I,Q}^{(1.1.1)}(\xi) + \mathbb{G}_{I,Q}^{(1.1.2)}(\xi) + \mathbb{G}_{I,Q}^{(1.1.3)}(\xi),$$

with

$$\begin{aligned} \mathbb{G}_{I,Q}^{(1.1.1)}(\xi) &= 2 \sum_{k=1}^{\infty} \sum_{\substack{q_k \in \mathcal{I}_{q,k} \\ q_{k+1} > 2Q}}^* \left((q_{k+1} - \xi Q)_+ \wedge q + (q_{k+1} - \xi Q)_+ \wedge q_k \right) \int_{t_k}^{t_{k-1}} \frac{w_{\mathcal{B}_k}(t) dt}{t^2 + t + 1}, \\ \mathbb{G}_{I,Q}^{(1.1.2)}(\xi) &= 2 \sum_{k=1}^{\infty} \sum_{\substack{q_k \in \mathcal{I}_{q,k} \\ q_{k+1} > 2Q}}^* (2q - \xi Q)_+ \wedge q \int_{t_k}^{t_{k-1}} \frac{2(a + \epsilon - qt) dt}{t^2 + t + 1}, \\ \mathbb{G}_{I,Q}^{(1.1.3)}(\xi) &= 2 \sum_{k=1}^{\infty} \sum_{\substack{q_k \in \mathcal{I}_{q,k} \\ q_{k+1} > 2Q}}^* \left((q_{k+2} - \xi Q)_+ \wedge q + (q_{k+2} - \xi Q)_+ \wedge q_{k+1} \right) \int_{t_k}^{t_{k-1}} \frac{w_{\mathcal{C}_k}(t) dt}{t^2 + t + 1}. \end{aligned}$$

This quantity is estimated employing (5.6), (10.1) and (5.7). The cumulative contribution of the error terms from those formulas to $\sum_I \mathbb{G}_{I,Q}^{(1.1)}(\xi)$ is

$$\ll \sum_I \sum_{\gamma \in \mathcal{F}_I(Q)} \sum_{k=1}^{\infty} \frac{1}{Qq q_{k-1}^2} \leq \sum_I \sum_{\gamma \in \mathcal{F}_I(Q)} \frac{1}{Qq} \left(\frac{1}{q^2} + \frac{1}{qq'} \right) \leq \frac{2}{Q} \sum_I \sum_{\gamma \in \mathcal{F}_I(Q)} \frac{1}{qq'} \leq \frac{6|I|}{Q},$$

so they can be discarded. Following the outline from the end of Section 5 we find

$$\mathbb{G}_{I,Q}^{(1.1)}(\xi) \approx \frac{c_I}{8\zeta(2)} \int_0^1 du \int_{2-u}^{\infty} dw F^{(1.1)}(\xi; u, w), \quad (6.6)$$

where

$$\begin{aligned} F^{(1.1)}(\xi; u, w) &= \frac{(1-u)^2}{(w-u)^2 w} \cdot \left((w+u-\xi)_+ \wedge u + (w+u-\xi)_+ \wedge w \right) \\ &\quad + \frac{1-u}{(w-u)w} \left(\frac{w+u-2}{w-u} + \frac{w+2u-2}{w} \right) \cdot (2u-\xi)_+ \wedge u \\ &\quad + \frac{(1-u)^2}{(w-u)w^2} \cdot \left((w+2u-\xi)_+ \wedge u + (w+2u-\xi)_+ \wedge (w+u) \right). \end{aligned}$$

6.3.2. $q_{k+1} \leq 2Q$. In this case $\frac{a+\varepsilon}{q} \leq \gamma_{k+1} \leq \frac{a_k-\varepsilon}{q_k}$. Furthermore, when $k \geq 1$ we have $\frac{a+\varepsilon}{q} \leq t_k \leq \gamma_{k+1} \leq \frac{a_k-\varepsilon}{q_k} \leq t_{k-1}$ if $q_{k+1} \leq 2Q - q$, and $t_k \leq \frac{a+\varepsilon}{q} \leq \gamma_{k+1} \leq \frac{a_k-\varepsilon}{q_k} \leq t_{k-1}$ if $2Q - q \leq q_{k+1} \leq 2Q$. When $k = 0$ the only difference is that $\gamma_1 = t_{-1} \leq \frac{a_0-\varepsilon}{q_0} = \frac{a'-\varepsilon}{q'}$. In this case the cumulative contribution of C_{\leftarrow} and C_{\downarrow} arising from (6.1)-(6.5) when $r = r_k = 1$ or $r = r_k = -1$ is

$$\mathbb{G}_{I,Q}^{(1.2)}(\xi) = \mathbb{G}_{I,Q}^{(1.2.1)}(\xi) + \dots + \mathbb{G}_{I,Q}^{(1.2.5)}(\xi),$$

with

$$\begin{aligned} \mathbb{G}_{I,Q}^{(1.2.1)}(\xi) &= 2 \sum_{k=1}^{\infty} \sum_{\substack{q_k \in \mathcal{I}_{q,k} \\ q_{k+1} \leq 2Q}}^* \int_{\frac{a_k-\varepsilon}{q_k}}^{t_{k-1}} \frac{W_{\gamma,k}^{(4)}(t) + W_{\gamma,k}^{(8)}(t)}{t^2 + t + 1} dt, \\ \mathbb{G}_{I,Q}^{(1.2.2)}(\xi) &= 2 \sum_{k=1}^{\infty} \sum_{\substack{q_k \in \mathcal{I}_{q,k} \\ q_{k+1} \leq 2Q}}^* \int_{\gamma_{k+1}}^{\frac{a_k-\varepsilon}{q_k}} \frac{W_{\gamma,k}^{(3)}(t) + W_{\gamma,k}^{(7)}(t)}{t^2 + t + 1} dt, \\ \mathbb{G}_{I,Q}^{(1.2.3)}(\xi) &= 2 \sum_{k=0}^{\infty} \sum_{\substack{q_k \in \mathcal{I}_{q,k} \\ q_{k+1} \leq 2Q-q}}^* \int_{t_k}^{\gamma_{k+1}} \frac{W_{\gamma,k}^{(2)}(t) + W_{\gamma,k}^{(6)}(t)}{t^2 + t + 1} dt, \\ \mathbb{G}_{I,Q}^{(1.2.4)}(\xi) &= 2 \sum_{k=0}^{\infty} \sum_{\substack{q_k \in \mathcal{I}_{q,k} \\ 2Q-q < q_{k+1} \leq 2Q}}^* \int_{t_k}^{\frac{a+\varepsilon}{q}} \frac{W_{\gamma,k}^{(1)}(t) + W_{\gamma,k}^{(5)}(t)}{t^2 + t + 1} dt, \\ \mathbb{G}_{I,Q}^{(1.2.5)}(\xi) &= 2 \sum_{k=0}^{\infty} \sum_{\substack{q_k \in \mathcal{I}_{q,k} \\ 2Q-q < q_{k+1} \leq 2Q}}^* \int_{\frac{a+\varepsilon}{q}}^{\gamma_{k+1}} \frac{W_{\gamma,k}^{(2)}(t) + W_{\gamma,k}^{(6)}(t)}{t^2 + t + 1} dt. \end{aligned}$$

The total contribution of the error terms from (10.2), (10.3) and (10.4) to $\sum_I \mathbb{G}_{I,Q}^{(1.2.1)}(\xi)$ is

$$\begin{aligned} &\ll \sum_I \sum_{\gamma \in \mathcal{F}_I(Q)} \sum_{k=1}^{\infty} \left(\frac{1}{qq^3} + \frac{1}{q^2 q_{k-1} q_k} \right) \leq \sum_I \sum_{\gamma \in \mathcal{F}_I(Q)} \left(\frac{1}{qq^3} + \frac{1}{Qq^2 q'} + \frac{1}{(qq')^2} + \frac{1}{q^3 q'} \right) \\ &\leq \frac{2}{Q} \sum_{\gamma \in \mathcal{F}(Q)} \frac{1}{qq'} + \frac{2}{Q} \sum_{q=1}^Q \frac{\varphi(q)}{q^2} + \sum_I \frac{8}{|I|Q} \ll Q^{c-1}, \end{aligned}$$

showing that they can be discarded in the sequel. The same holds for $\mathbb{G}_{I,Q}^{(1.2.2)}(\xi), \dots, \mathbb{G}_{I,Q}^{(1.2.5)}(\xi)$, where for $\mathbb{G}_{I,Q}^{(1.2.4)}(\xi)$ and $\mathbb{G}_{I,Q}^{(1.2.5)}(\xi)$ one uses the fact that k takes exactly one value as a result of $q_{k+1} \in (2Q - q, 2Q]$.

Employing (10.2), (10.3), (10.4), and proceeding as in Section 5 we find

$$\mathbb{G}_{I,Q}^{(1.2.1)}(\xi) \cong \frac{c_I}{8\zeta(2)} \int_0^1 du \int_1^{2-u} dw F^{(1.2.1)}(\xi; u, w), \quad (6.7)$$

with

$$\begin{aligned} F^{(1.2.1)}(\xi; u, w) &= \frac{(2-u-w)^2}{4(w-u)w^2} \cdot \left((2w+u-\xi)_+ \wedge w + (2w+u-\xi)_+ \wedge (w+u) \right) \\ &+ \frac{2-u-w}{2(w-u)w} \left(\frac{2w+u-2}{2w} + \frac{w-1}{w-u} \right) \cdot \left((w+u-\xi)_+ \wedge u + (w+u-\xi)_+ \wedge w \right) \\ &+ \frac{(2-u-w)^2}{2(w-u)^2w} \cdot (2w-\xi)_+ \wedge w. \end{aligned}$$

Employing (10.5), (10.6) and (10.7) we find

$$\mathbb{G}_{I,Q}^{(1.2.2)}(\xi) \cong \frac{c_I}{8\zeta(2)} \int_0^1 du \int_1^{2-u} dw F^{(1.2.2)}(\xi; u, w), \quad (6.8)$$

with

$$\begin{aligned} F^{(1.2.2)}(\xi; u, w) &= \frac{(2-u-w)^2}{4w^2(w+u)} \cdot \left((2w+u-\xi)_+ \wedge w + (2w+u-\xi)_+ \wedge (w+u) \right) \\ &+ \frac{2-u-w}{2w(w+u)} \left(\frac{w+u-1}{w+u} + \frac{2w+u-2}{2w} \right) \cdot \left((w+u-\xi)_+ \wedge u + (w+u-\xi)_+ \wedge w \right) \\ &+ \frac{(2-u-w)^2}{2w(w+u)^2} \cdot (2w+2u-\xi)_+ \wedge (w+u). \end{aligned}$$

Employing (10.8), (10.9) and (10.10) we find

$$\mathbb{G}_{I,Q}^{(1.2.3)}(\xi) \cong \frac{c_I}{8\zeta(2)} \int_0^1 du \int_{1-u}^{2-2u} dw F^{(1.2.3)}(\xi; u, w), \quad (6.9)$$

with

$$\begin{aligned} F^{(1.2.3)}(\xi; u, w) &= \frac{(w+u-1)^2}{w(w+u)^2} \cdot \left((w+u-\xi)_+ \wedge u + (w+u-\xi)_+ \wedge w \right) \\ &+ \frac{w+u-1}{w(w+u)} \left(\frac{2-u-w}{w+u} + \frac{2-2u-w}{w} \right) \cdot (2w+2u-\xi)_+ \wedge (w+u) \\ &+ \frac{(w+u-1)^2}{w^2(w+u)} \cdot \left((w+2u-\xi)_+ \wedge u + (w+2u-\xi)_+ \wedge (w+u) \right). \end{aligned}$$

Employing (10.13)-(10.17) we find

$$\mathbb{G}_{I,Q}^{(1.2.4)}(\xi) \cong \frac{c_I}{8\zeta(2)} \int_0^1 du \int_{2-2u}^{2-u} dw F^{(1.2.4)}(\xi; u, w), \quad (6.10)$$

with

$$\begin{aligned}
F^{(1.2.4)}(\xi; u, w) &= \frac{(w + 2u - 2)^2}{4u^2w} \cdot ((w + u - \xi)_+ \wedge u + (w + u - \xi)_+ \wedge w) \\
&+ \frac{w + 2u - 2}{2uw} \left(\frac{2 - u - w}{2u} + \frac{1 - u}{w} \right) \cdot ((w + 2u - \xi)_+ \wedge u + (w + 2u - \xi)_+ \wedge (w + u)) \\
&+ \frac{(w + 2u - 2)^2}{2uw^2} \cdot (2u - \xi)_+ \wedge u.
\end{aligned}$$

Employing (10.17), (10.18) and (10.19) we find

$$\mathbb{G}_{I, Q}^{(1.2.5)}(\xi) \cong \frac{c_I}{8\zeta(2)} \int_0^1 du \int_{2-2u}^{2-u} dw F^{(1.2.5)}(\xi; u, w), \quad (6.11)$$

with

$$\begin{aligned}
F^{(1.2.5)}(\xi; u, w) &= \frac{(2 - u - w)^2}{4u^2(w + u)} \cdot ((w + 2u - \xi)_+ \wedge u + (w + 2u - \xi)_+ \wedge (w + u)) \\
&+ \frac{2 - u - w}{2u(w + u)} \left(\frac{w + u - 1}{w + u} + \frac{w + 2u - 2}{2u} \right) \cdot ((w + u - \xi)_+ \wedge u + (w + u - \xi)_+ \wedge w) \\
&+ \frac{(2 - u - w)^2}{2u(w + u)^2} \cdot (2w + 2u - \xi)_+ \wedge (w + u).
\end{aligned}$$

7. CHANNELS WITH REMOVED SLITS. THE CASE $r = 0$

In this case $r_k = \pm 1$. The C_O contributions for $(r, r_k) = (0, 1)$ and respectively $(r, r_k) = (0, -1)$ do coincide. The C_{\leftarrow} contribution for $(r, r_k) = (0, 1)$ coincides with the C_{\downarrow} contribution for $(r, r_k) = (0, -1)$. We shall sum as in (5.2), considering

$$\sum^* = \sum_{\substack{\gamma \in \mathcal{F}_I(Q) \\ q \equiv a \pmod{3} \\ q_k \not\equiv a_k \pmod{3}}}^*.$$

It suffices to only analyze the C_O and C_{\leftarrow} contributions of $(r, r_k) = (0, 1)$, allowing at the very end β to take both values -1 and 1 . The final result will express the C_O contribution when $(r, r_k) = (0, \pm 1)$, and respectively the sum of the C_{\leftarrow} contribution for $(r, r_k) = (0, 1)$ and of the C_{\downarrow} contribution for $(r, r_k) = (0, -1)$.

7.1. The C_O contribution. The situation is described in Figure 12. Two cases arise:

7.1.1. $w_{\mathcal{A}_0} \leq w_{\mathcal{B}_k}$ ($\iff t \geq \gamma_{k+1}$). In this case $k \geq 1$. Since $\gamma_{k+1} \leq t_{k-1}$, we must also have $q_{k+1} \leq 2Q$. The channel \mathcal{A}_0 is locked by the slit q_{k+1} and $W_{\gamma, k}(t) = w_{\mathcal{A}_0}(t) \cdot (q_{k+1} - \xi Q)_+ \wedge q$, with contribution

$$\mathbb{G}_{I, Q}^{(2.1)}(\xi) = \sum_{k=1}^{\infty} \sum_{\substack{q_k \in \mathcal{I}_{q, k} \\ q_{k+1} \leq 2Q}}^* (q_{k+1} - \xi Q)_+ \wedge q \int_{\gamma_{k+1}}^{t_{k-1}} \frac{w_{\mathcal{A}_0}(t) dt}{t^2 + t + 1},$$

estimated in Subsection 11.1.1 as

$$\cong \frac{c_I}{8\zeta(2)} \int_0^1 du \int_1^{2-u} dw \frac{2 - u - w}{(w - u)(w + u)} \left(\frac{w + u - 1}{w + u} + \frac{w - 1}{w - u} \right) \cdot (w + u - \xi)_+ \wedge u. \quad (7.1)$$

7.1.2. $w_{\mathcal{A}_0} > w_{\mathcal{B}_k}$ ($\iff t < \gamma_{k+1}$) and $\xi Q < q_{k+1}$. In this situation we have

$$W_{\gamma,k}(t) = w_{\mathcal{B}_k}(t)(q_{k+1} - \xi Q) + (w_{\mathcal{A}_0}(t) - w_{\mathcal{B}_k}(t))q,$$

with contribution (according to whether $\gamma_{k+1} \leq t_{k-1}$ or $t_{k-1} < \gamma_{k+1}$)

$$\mathbb{G}_{I,Q}^{(2.2)}(\xi) = \sum_{k=0}^{\infty} \sum_{\substack{q_k \in I_{q,k} \\ \xi Q < q_{k+1} \leq 2Q}}^* \int_{t_k}^{\gamma_{k+1}} \frac{W_{\gamma,k}(t) dt}{t^2 + t + 1} + \sum_{k=1}^{\infty} \sum_{\substack{q_k \in I_{q,k} \\ q_{k+1} > (\xi \vee 2)Q}}^* \int_{t_k}^{t_{k-1}} \frac{W_{\gamma,k}(t) dt}{t^2 + t + 1}.$$

Employing (10.8), (10.9), respectively (5.6), (11.2) and the procedure described at the beginning of Appendix 2 we find

$$\mathbb{G}_{I,Q}^{(2.2)}(\xi) \cong \frac{c_I}{8\zeta(2)} \int_0^1 du \left(\int_{(\xi \vee 1) \wedge 2 - u}^{2-u} dw F^{(2.2.1)}(\xi; u, w) + \int_{\xi \vee 2 - u}^{\infty} dw F^{(2.2.2)}(\xi; u, w) \right), \quad (7.2)$$

with

$$F^{(2.2.1)}(\xi; u, w) = \frac{(w + u - 1)^2}{w(w + u)} \left(\frac{w + u}{w} - \frac{\xi}{w + u} \right),$$

$$F^{(2.2.2)}(\xi; u, w) = \frac{(1 - u)^2(w + u - \xi)}{(w - u)^2 w} + \frac{(1 - u)u}{(w - u)w} \left(\frac{w + u - 1}{w} + \frac{w + u - 2}{w - u} \right).$$

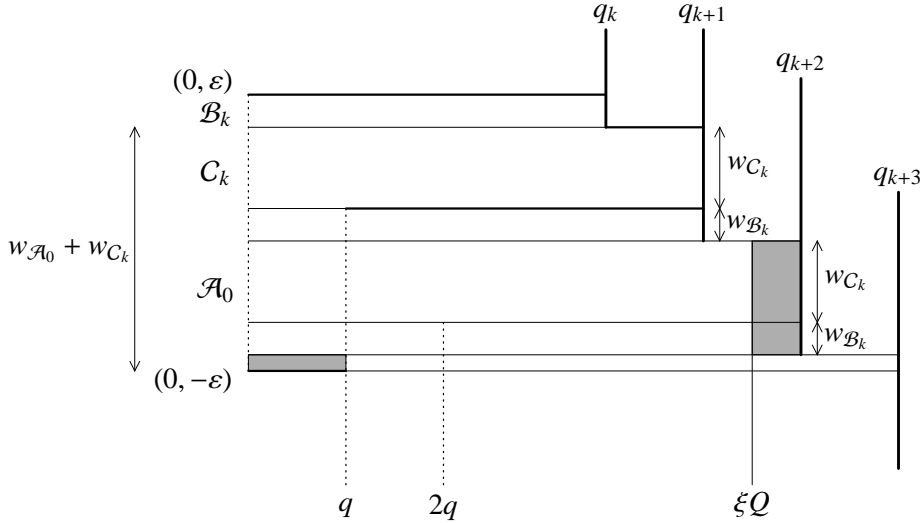

FIGURE 12. The case $t \in I_{\gamma,k}$, $r = 0$, $r_k = \pm 1$, C_O , $w_{\mathcal{B}_k} < w_{\mathcal{A}_0}$, $n_0 = 2$, $N = 1$

7.1.3. $w_{\mathcal{A}_0} > w_{\mathcal{B}_k}$ ($\iff t < \gamma_{k+1}$) and $\xi Q \geq q_{k+1}$. Consider the integer N for which $q_{k+N} \leq \xi Q < q_{k+N+1}$, that is $1 \leq N := \left\lfloor \frac{\xi Q - q_k}{q} \right\rfloor$. We will keep $N \geq 1$ and $q \leq Q$ fixed and sum over

$$y = q_k \in \mathcal{J}_{q,N} := (\xi Q - (N + 1)q, \xi Q - Nq].$$

Let $n_0 := \left\lfloor \frac{w_{\mathcal{A}_0} + w_{C_k}}{w_{\mathcal{B}_k} + w_{C_k}} \right\rfloor = \left\lfloor \frac{a_k - qk t}{qt - a} \right\rfloor \geq 1$, so $\gamma_{k+n_0+1} < t \leq \gamma_{k+n_0}$ and $B(q_{k+n_0}) = w_{\mathcal{B}_k} + n_0(w_{\mathcal{B}_k} + w_{C_k}) \leq 2\varepsilon < B(q_{k+n_0+1})$. This shows that the channel \mathcal{A}_0 is locked by the slits $q_{k+1}, \dots, q_{k+n_0}, q_{k+n_0+1}$. Suppose that $N \geq \xi$. Then $q_k \leq \xi Q - Nq \leq N(Q - q)$, showing that $q_{k+N} \leq NQ$ and $\gamma_{k+N} < t_k$. So $n_0 < N$ and

$\xi Q \geq q_{k+N} \geq q_{k+n_0+1}$, showing that in this case $W_{\gamma,k,N}(t) = 0, \forall t \in I_{\gamma,k}$. It remains that $N < \xi$. The following cases arise:

(1) $B(q_{k+N}) \leq 2\varepsilon < B(q_{k+N+1})$ ($\iff \gamma_{k+N+1} < t \leq \gamma_{k+N}$). In this case

$$\begin{aligned} W_{\gamma,k,N}(t) &= W_{\gamma,k,N}^{(1)}(t) := (2\varepsilon - B(q_{k+N}))(q_{k+N+1} - \xi Q) \\ &= (a_{k+N} - q_{k+N}t)(q_{k+N+1} - \xi Q). \end{aligned} \quad (7.3)$$

(2) $B(q_{k+N+1}) \leq 2\varepsilon$ ($\iff t \leq \gamma_{k+N+1}$). In this case

$$\begin{aligned} W_{\gamma,k,N}(t) &= W_{\gamma,k}^{(2)}(t) := (w_{B_k}(t) + w_{C_k}(t))(q_{k+N+1} - \xi Q) + (2\varepsilon - B(q_{k+N+1}))q \\ &= 1 - \xi Q(w_{B_k}(t) + w_{C_k}(t)). \end{aligned} \quad (7.4)$$

We find

$$\begin{aligned} \mathbb{G}_{I,Q}^{(2,3)}(\xi) &= \sum_{1 \leq N < \xi} \sum_{k=0}^{\infty} \sum_{q_k \in I_{q,k} \cap \mathcal{J}_{q,N}}^* \left(\int_{I_{\gamma,k} \cap (\gamma_{k+N+1}, \gamma_{k+N}] } \frac{W_{\gamma,k,N}^{(1)}(t) dt}{t^2 + t + 1} + \int_{I_{\gamma,k} \cap (\gamma, \gamma_{k+N+1}] } \frac{W_{\gamma,k,N}^{(2)}(t) dt}{t^2 + t + 1} \right) \\ &= \mathbb{G}_{I,Q}^{(2,3,1)}(\xi) + \mathbb{G}_{I,Q}^{(2,3,2)}(\xi). \end{aligned}$$

Note that

$$I_{\gamma,k} \cap (\gamma_{k+N+1}, \gamma_{k+N}] = \begin{cases} \emptyset & \text{if } q_k < N(Q - q) \text{ or } Q + (N + 1)(Q - q) \leq q_k, \\ (t_k, \gamma_{k+N}] & \text{if } N(Q - q) \leq q_k < (N + 1)(Q - q), \\ (\gamma_{k+N+1}, \gamma_{k+N}] & \text{if } (N + 1)(Q - q) \leq q_k < Q + N(Q - q), \\ (\gamma_{k+N+1}, t_{k-1}] & \text{if } Q + N(Q - q) \leq q_k < Q + (N + 1)(Q - q), \end{cases}$$

and respectively

$$I_{\gamma,k} \cap (\gamma, \gamma_{k+N+1}] = \begin{cases} \emptyset & \text{if } q_k < (N + 1)(Q - q), \\ (t_k, \gamma_{k+N+1}] & \text{if } (N + 1)(Q - q) \leq q_k < Q + (N + 1)(Q - q), \\ I_{\gamma,k} & \text{if } Q + (N + 1)(Q - q) \leq q_k. \end{cases}$$

Summing as in (5.2) and employing (11.3), (11.4), (11.5) and Lemmas 4 and 2, then changing $y + Nq$ to y and making the substitution $(q, y) = (Qu, Qw)$, we find

$$\begin{aligned} \mathbb{G}_{I,Q}^{(2,3,1)}(\xi) &\cong \frac{c_I}{8\xi(2)} \sum_{1 \leq N < \xi} \int_0^1 du \left\{ \int_{[\xi-u, \xi] \cap [N, N+1-u]} dw \frac{(w+u-\xi)(w-N)^2}{(w-Nu)^2 w} \right. \\ &\quad \left. + \int_{[\xi-u, \xi] \cap [N+1-u, N+1]} dw \frac{w+u-\xi}{(w+u)^2 w} \right. \\ &\quad \left. + \int_{[\xi-u, \xi] \cap [N+1, N+2-u]} dw \frac{(w+u-\xi)(N+2-u-w)}{(w-(N+1)u)(w+u)} \left(\frac{1}{w+u} + \frac{w-(N+1)}{w-(N+1)u} \right) \right\}. \end{aligned} \quad (7.5)$$

In a similar way (but replacing $y + (N + 1)q$ by y) we infer from (11.6) and (11.7) that

$$\begin{aligned} \mathbb{G}_{I,Q}^{(2.3.2)}(\xi) &\cong \frac{c_I}{8\zeta(2)} \sum_{1 \leq N < \xi} \int_0^1 du \int_{[\xi, \xi+u] \cap [N+1, N+2]} dw \frac{w - (N + 1)}{(w - (N + 1)u)w} \\ &\quad \cdot \left(2 - \frac{\xi}{w} - \frac{\xi(1-u)}{w - (N + 1)u} \right) \\ &+ \frac{c_I}{8\zeta(2)} \sum_{1 \leq N < \xi} \int_0^1 du \int_{[\xi, \xi+u] \cap [N+2, \infty)} dw \frac{1-u}{(w - (N + 2)u)(w - (N + 1)u)} \\ &\quad \cdot \left(2 - \frac{\xi(1-u)}{w - (N + 2)u} - \frac{\xi(1-u)}{w - (N + 1)u} \right). \end{aligned} \quad (7.6)$$

The inner integrals in (7.5) and the first one in (7.6) can be nonzero only when $N > \xi - 1$, $\xi - 2 < N < \xi$ or $\xi - 2 < N < \xi - 1$.

7.2. The C_{\leftarrow} contribution. In this case we shall analyze the contribution of the channels \mathcal{B}_k and C_k . All slits q_{k+n} , $n \in \mathbb{Z}$, are removed, while neither q nor any of $2q_k + nq = q_k + q_{k+n}$, $n \in \mathbb{Z}$, is being removed. Since $T(2q_k) = -2w_{\mathcal{A}_0} - 2w_{C_k} < 0$ and $B(2q_k + nq) = w_{\mathcal{B}_k} - w_{\mathcal{A}_0} - w_{C_k} + n(w_{\mathcal{B}_k} + w_{C_k})$, it follows that $\mathcal{B}_k \cup C_k$ is locked exactly by two of the slits $2q_k + nq$, $n \geq 0$. To make this precise let $n_0 := \lfloor \frac{w_{\mathcal{A}_0} + 2w_{C_k}}{w_{\mathcal{B}_k} + w_{C_k}} \rfloor = \lfloor \frac{a_k + a_{k-1} - 2\varepsilon - (q_k + q_{k-1})t}{qt - a} \rfloor \geq 0$. We have $0 < B(2q_k + n_0q) = w_{\mathcal{B}_k} - w_{\mathcal{A}_0} - w_{C_k} + n_0(w_{\mathcal{B}_k} + w_{C_k}) \leq w_{\mathcal{B}_k} + w_{C_k}$. The situation is described in Figure 13. Consider also

$$\lambda_{k,n} := \frac{a_k + a_{k+n-1} - 2\varepsilon}{q_k + q_{k+n-1}} \searrow \gamma \quad \text{as } n \rightarrow \infty, \quad (7.7)$$

so $\lambda_{k,n_0+1} < t \leq \lambda_{k,n_0}$. Note that $\lambda_{0,1} \geq t_{-1} = \gamma_1 > \lambda_{0,2}$ and $\lambda_{k,0} > t_{k-1}$ when $k \geq 1$, showing that for every $k \geq 0$ the intervals $(\lambda_{k,n+1}, \lambda_{k,n}]$ cover $I_{\gamma,k}$. The following cases arise:

7.2.1. $0 < B(2q_k + n_0q) \leq w_{\mathcal{B}_k}$ ($\iff \lambda_{k,n_0+1} < t \leq \gamma_{k+n_0}$). In this case C_k is locked by the slit $2q_k + (n_0 + 1)q$ and \mathcal{B}_k by the slits $2q_k + n_0q = q_k + q_{k+n_0}$ and $2q_k + (n_0 + 1)q = q_k + q_{k+n_0+1}$. The widths of the three relevant sub-channels of $\mathcal{B}_k \cup C_k$ are (from bottom to top) w_{C_k} , $w_{\mathcal{B}_k} - B(2q_k + n_0q) = a_{k+n_0} - q_{k+n_0}t$, $B(2q_k + n_0q) = w_{\mathcal{B}_k} - (a_{k+n_0} - q_{k+n_0}t)$, and so

$$\begin{aligned} W_{\gamma,k}(t) = W_{\gamma,k,n_0}^{(1)}(t) &= w_{C_k}(t) \cdot (q_{k+1} + q_{k+n_0} - \xi Q)_+ \wedge q_{k+1} + w_{\mathcal{B}_k}(t) \cdot (q_k + q_{k+n_0} - \xi Q)_+ \wedge q_k \\ &+ (a_{k+n_0} - q_{k+n_0}t) \cdot \left((q_{k+1} + q_{k+n_0} - \xi Q)_+ \wedge q_k - (q_k + q_{k+n_0} - \xi Q)_+ \wedge q_k \right). \end{aligned}$$

7.2.2. $w_{\mathcal{B}_k} < B(2q_k + n_0q) \leq w_{\mathcal{B}_k} + w_{C_k}$ ($\iff \gamma_{k+n_0} < t \leq \lambda_{k,n_0}$). In this case \mathcal{B}_k is locked by the slit $q_k + q_{k+n_0}$ and C_k by the slits $q_k + q_{k+n_0}$ and $q_k + q_{k+n_0+1}$. The widths of the three relevant sub-channels of $\mathcal{B}_k \cup C_k$ are $w_{\mathcal{B}_k} + w_{C_k} - B(2q_k + n_0q) = w_{C_k} - (q_{k+n_0}t - a_{k+n_0})$, $B(2q_k + n_0q) - w_{\mathcal{B}_k} = q_{k+n_0}t - a_{k+n_0}$, $w_{\mathcal{B}_k}$, and so

$$\begin{aligned} W_{\gamma,k}(t) = W_{\gamma,k,n_0}^{(2)}(t) &= w_{C_k}(t) \cdot (q_{k+1} + q_{k+n_0} - \xi Q)_+ \wedge q_{k+1} + w_{\mathcal{B}_k}(t) \cdot (q_k + q_{k+n_0} - \xi Q)_+ \wedge q_k \\ &- (q_{k+n_0}t - a_{k+n_0}) \cdot \left((q_{k+1} + q_{k+n_0} - \xi Q)_+ \wedge q_{k+1} - (q_k + q_{k+n_0} - \xi Q)_+ \wedge q_{k+1} \right). \end{aligned}$$

The following five cases arise:

(I) $q_k < (n - 1)(Q - q)$. Then $\lambda_{k,n} < t_k$, thus $I_{\gamma,k} \cap (\lambda_{k,n+1}, \lambda_{k,n}] = \emptyset$.

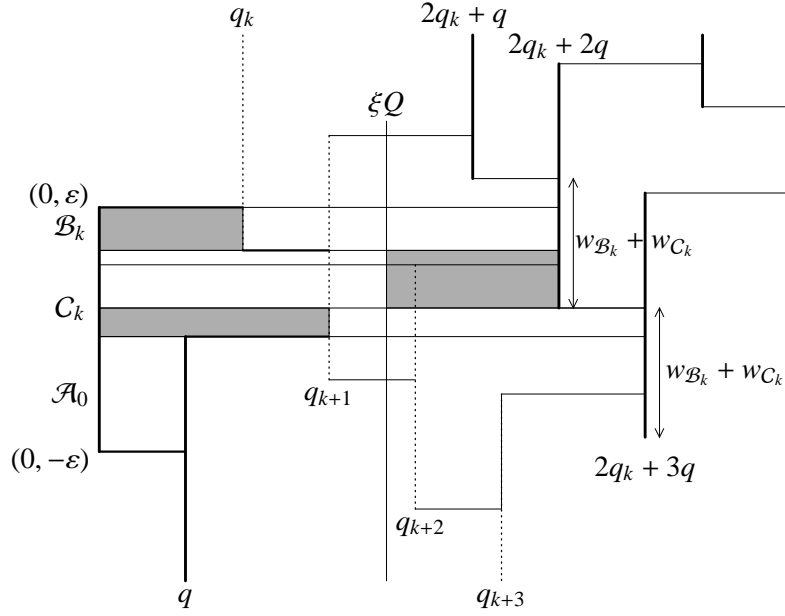

FIGURE 13. The case $t \in I_{\gamma,k}$, $r = 0$, $r_k = 1$, C_{\leftarrow} , $n_0 = 2$, $w_{B_k} < B(2q_k + n_0q) \leq w_{B_k} + w_{C_k}$

(II) $(n-1)(Q-q) \leq q_k < n(Q-q)$. Then $n \geq 2$ and $\gamma_{k+n} < t_k \leq \lambda_{k,n} < t_{k-1}$ in both cases $k \geq 1$ and $k = 0$. The corresponding contribution is

$$\mathbb{G}_{I,Q}^{(2.4.1)}(\xi) = \sum_{n=2}^{\infty} \sum_{k=0}^{\infty} \sum_{\substack{q_k \in I_{q,k} \\ (n-1)(Q-q) \leq q_k < n(Q-q)}}^* \int_{t_k}^{\lambda_{k,n}} \frac{W_{\gamma,k,n}^{(2)}(t) dt}{t^2 + t + 1}.$$

Employing (11.8)-(11.11), Lemmas 8 and 3, and the change of variable $(q, y) = (Qu, Qw)$ we find (according to whether $k = 0$ or $k \geq 1$)

$$\begin{aligned} \mathbb{G}_{I,Q}^{(2.4.1)}(\xi) &\approx \frac{c_I}{8\zeta(2)} \sum_{n=2}^{\infty} \int_{1-\frac{1}{n-1}}^1 du \int_{(n-1)(1-u)}^1 dw F_n^{(2.4.1)}(\xi; u, w) \\ &\quad + \frac{c_I}{8\zeta(2)} \sum_{n=2}^{\infty} \int_0^{1-\frac{1}{n-1}} du \int_{(n-1)(1-u)}^{n(1-u)} dw F_n^{(2.4.1)}(\xi; u, w) \\ &\quad + \frac{c_I}{8\zeta(2)} \sum_{n=2}^{\infty} \int_{1-\frac{1}{n-1}}^{1-\frac{1}{n}} du \int_1^{n(1-u)} dw F_n^{(2.4.1)}(\xi; u, w), \end{aligned} \tag{7.8}$$

where

$$\begin{aligned} F_n^{(2.4.1)}(\xi; u, w) &= \frac{(w - (n-1)(1-u))^2}{w(2w + (n-1)u)^2} \cdot (2w + nu - \xi)_+ \wedge w \\ &\quad + \frac{w - (n-1)(1-u)}{w(2w + (n-1)u)} \left(\frac{1-u}{w} - \frac{n(1-u) - w}{w} \right) \cdot (2w + (n+1)u - \xi)_+ \wedge (w+u) \\ &\quad + \frac{w - (n-1)(1-u)}{w(2w + (n-1)u)} \left(\frac{1+n(1-u) - w}{2w + (n-1)u} + \frac{n(1-u) - w}{w} \right) \cdot (2w + nu - \xi)_+ \wedge (w+u). \end{aligned}$$

(III) $n(Q - q) \leq q_k < Q + n(Q - q)$. Upon $\lambda_{0,2} < \gamma_1 = t_{-1} \leq \lambda_{0,1} = \frac{q' - \varepsilon}{q'}$ we see that $I_{\gamma,k} \cap (\lambda_{k,n+1}, \lambda_{k,n}] = (\lambda_{k,n+1}, \gamma_{k+n}] \cup (\gamma_{k+n}, \lambda_{k,n}]$ when $k \geq 1$ and when $k = 0$ and $n \geq 2$. When $k = 0$ and $n = 1$ this interval coincides with $(\lambda_{0,2}, \gamma_1]$. The cumulative contribution is thus

$$\begin{aligned} \mathbb{G}_{I,Q}^{(2.4.2)}(\xi) &= \sum_{n=1}^{\infty} \sum_{k=1}^{\infty} \sum_{\substack{q_k \in \mathcal{I}_{q,k} \\ n(Q-q) \leq q_k < Q+n(Q-q)}}^* \left(\int_{\lambda_{k,n+1}}^{\gamma_{k+n}} \frac{W_{\gamma,k,n}^{(1)}(t) dt}{t^2 + t + 1} + \int_{\gamma_{k+n}}^{\lambda_{k,n}} \frac{W_{\gamma,k,n}^{(2)}(t) dt}{t^2 + t + 1} \right) \\ &+ \sum_{n=2}^{\infty} \sum_{\substack{q' \in \mathcal{I}_{q,0} \\ q' \geq n(Q-q)}}^* \left(\int_{\lambda_{0,n+1}}^{\gamma_n} \frac{W_{\gamma,0,n}^{(1)}(t) dt}{t^2 + t + 1} + \int_{\gamma_n}^{\lambda_{0,n}} \frac{W_{\gamma,0,n}^{(2)}(t) dt}{t^2 + t + 1} \right) + \sum_{q' \in \mathcal{I}_{q,0}}^* \int_{\lambda_{0,2}}^{\gamma_1} \frac{W_{\gamma,0,1}^{(1)}(t) dt}{t^2 + t + 1} \\ &= \mathbb{G}_{I,Q}^{(2.4.2.1)}(\xi) + \mathbb{G}_{I,Q}^{(2.4.2.2)}(\xi) + \mathbb{G}_{I,Q}^{(2.4.2.3)}(\xi). \end{aligned}$$

For fixed k we have $\frac{q_k - Q}{Q - q} < n \leq \frac{q_k}{Q - q}$, so n can take at most $1 + \lfloor \frac{Q}{Q - q} \rfloor \leq \frac{2Q}{Q - q}$ values. Employing (11.12)-(11.15) we find

$$\mathbb{G}_{I,Q}^{(2.4.2.1)}(\xi) \approx \frac{c_I}{8\zeta(2)} \sum_{n=1}^{\infty} \int_0^1 du \int_{n(1-u) \vee 1}^{n(1-u)+1} dw F_n^{(2.4.2)}(\xi; u, w), \quad (7.9)$$

where

$$\begin{aligned} F_n^{(2.4.2)}(\xi; u, w) &= \frac{2 - u}{(2w + (n - 1)u)(2w + nu)} \\ &\cdot \left(\frac{1 + (n + 1)(1 - u) - w}{2w + nu} + \frac{1 + n(1 - u) - w}{2w + (n - 1)u} \right) \cdot (2w + (n + 1)u - \xi)_+ \wedge (w + u) \\ &+ \frac{2 - u}{(2w + (n - 1)u)(2w + nu)} \left(\frac{w - (n - 1)(1 - u)}{2w + (n - 1)u} + \frac{w - n(1 - u)}{2w + nu} \right) \cdot (2w + nu - \xi)_+ \wedge w \\ &+ \frac{(w - n(1 - u))^2}{(w + nu)(2w + nu)^2} \cdot ((2w + (n + 1)u - \xi)_+ \wedge w - (2w + nu - \xi)_+ \wedge w) \\ &- \frac{(1 + n(1 - u) - w)^2}{(w + nu)(2w + (n - 1)u)^2} \cdot ((2w + (n + 1)u - \xi)_+ \wedge (w + u) - (2w + nu - \xi)_+ \wedge (w + u)). \end{aligned}$$

Employing (11.13)-(11.16) we find

$$\mathbb{G}_{I,Q}^{(2.4.2.2)}(\xi) \approx \frac{c_I}{8\zeta(2)} \sum_{n=2}^{\infty} \int_0^1 du \int_{n(1-u) \wedge 1}^1 dw F_n^{(2.4.2)}(\xi; u, w). \quad (7.10)$$

From (7.9) and (7.10) we gather

$$\begin{aligned} \mathbb{G}_{I,Q}^{(2.4.2.1)}(\xi) + \mathbb{G}_{I,Q}^{(2.4.2.2)}(\xi) &\approx \frac{c_I}{8\zeta(2)} \int_0^1 du \int_1^{2-u} dw F_1^{(2.4.2)}(\xi; u, w) \\ &+ \frac{c_I}{8\zeta(2)} \sum_{n=1}^{\infty} \int_{n(1-u)}^{n(1-u)+1} dw F_n^{(2.4.2)}(\xi; u, w). \end{aligned} \quad (7.11)$$

Employing (11.17), (11.18), (11.19) we find

$$\mathbb{G}_{I,Q}^{(2.4.2.3)}(\xi) \approx \frac{c_I}{8\zeta(2)} \int_0^1 du \int_{1-u}^1 dw F^{(2.4.2.3)}(\xi; u, w), \quad (7.12)$$

where

$$F^{(2.4.2.3)}(\xi; u, w) = \frac{w+u-1}{(w+u)(2w+u)} \left(\frac{3-2u-w}{2w+u} + \frac{2-u-w}{w+u} \right) \cdot (2w+2u-\xi)_+ \wedge (w+u) \\ + \frac{(w+u-1)^2}{(w+u)^2(2w+u)} \cdot (2w+u-\xi)_+ \wedge w + \frac{(w+u-1)^2}{(w+u)(2w+u)^2} \cdot (2w+2u-\xi)_+ \wedge w.$$

(IV) $Q+n(Q-q) \leq q_k < Q+(n+1)(Q-q)$. Then $k \geq 1$ and $(n+2)Q - q_{k+n+1} \leq Q-q$. In this case $I_{\gamma,k} \cap (\lambda_{k,n+1}, \lambda_{k,n}] = (\lambda_{k,n+1}, t_{k-1}]$ and $t_{k-1} < \gamma_{k+n}$, so the corresponding contribution is

$$\mathbb{G}_{I,Q}^{(2.4.3)}(\xi) = \sum_{n=0}^{\infty} \sum_{k=1}^{\infty} \sum_{\substack{q_k \in \mathcal{I}_{q,k} \\ Q+n(Q-q) \leq q_k < Q+(n+1)(Q-q)}}^* \int_{\lambda_{k,n+1}}^{t_{k-1}} \frac{W_{\gamma,k,n}^{(1)}(t) dt}{t^2 + t + 1}.$$

Note also that n can only take the value $n = \lfloor \frac{q_k - Q}{Q - q} \rfloor$ for each k . Employing (11.20), (11.21), (11.22) we find

$$\mathbb{G}_{I,Q}^{(2.4.3)}(\xi) \approx \frac{c_I}{8\zeta(2)} \sum_{n=0}^{\infty} \int_0^1 du \int_{n(1-u)+1}^{(n+1)(1-u)+1} dw F_n^{(2.4.3)}(\xi; u, w), \quad (7.13)$$

where

$$F_n^{(2.4.3)}(\xi; u, w) = \frac{(1+(n+1)(1-u)-w)^2}{(w-u)(2w+nu)^2} \cdot (2w+(n+1)u-\xi)_+ \wedge (w+u) \\ + \frac{(1+(n+1)(1-u)-w)^2}{(w-u)^2(2w+nu)} \cdot (2w+nu-\xi)_+ \wedge w \\ + \frac{1+(n+1)(1-u)-w}{(w-u)(2w+nu)} \left(\frac{w-n(1-u)}{2w+nu} + \frac{w-n(1-u)-1}{w-u} \right) \cdot (2w+(n+1)u-\xi)_+ \wedge w.$$

(V) $q_k \geq Q+(n+1)(Q-q)$. Then $k \geq 1$, $\lambda_{k,n+1} \geq t_{k-1}$ and $I_{\gamma,k} \cap (\lambda_{k,n+1}, \lambda_{k,n}] = \emptyset$.

8. CHANNELS WITH REMOVED SLITS. THE CASE $r_k = 0$

The main term and the error term of the C_O contribution of $(r, r_k) = (1, 0)$ and of $(r, r_k) = (-1, 0)$ coincide because the corresponding weights are given by the same formulas and one only has to replace the summation condition $q-a \equiv 1 \pmod{3}$ by $q-a \equiv -1 \pmod{3}$. The same thing holds for the C_{\leftarrow} contribution of $(r, r_k) = (1, 0)$ and the C_{\downarrow} contribution of $(r, r_k) = (-1, 0)$ (see Figure 8). So it suffices to take $(r, r_k) = (0, 1)$ in the sequel, doubling the C_O and the C_{\leftarrow} contributions. This time we consider

$$\sum^* = \sum_{\substack{\gamma \in \mathcal{F}_I(Q) \\ q-a \equiv 1 \pmod{3} \\ q_k \equiv a_k \pmod{3}}}^* .$$

8.1. The channel C_O . The slit q_k is removed, while $q+nq_k$, $n \geq 0$, are not, as shown in Figure 14. The following three cases arise:

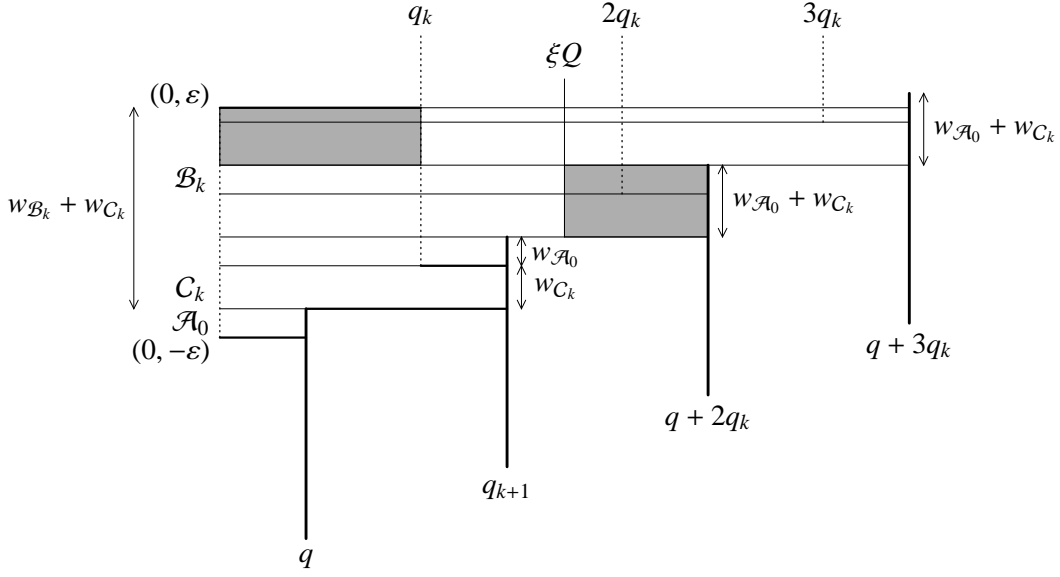
 FIGURE 14. The case $t \in I_{\gamma,k}$, $r_k = 0$, C_O , $w_{\mathcal{A}_0} < w_{\mathcal{B}_k}$, $n_0 = 2$, $N = 1$

8.1.1. $w_{\mathcal{A}_0} \geq w_{\mathcal{B}_k}$ ($\iff t \leq \gamma_{k+1}$). The channel \mathcal{B}_k is locked by the slit q_{k+1} and $W_{\gamma,k}(t) = w_{\mathcal{B}_k}(t) \cdot (q_{k+1} - \xi Q)_+ \wedge q_k$, with contribution

$$\mathbb{G}_{I,Q}^{(3.1)}(\xi) = \sum_{k=0}^{\infty} \sum_{\substack{q_k \in I_{q,k} \\ q_{k+1} \leq 2Q}}^* \int_{t_k}^{\gamma_{k+1}} \frac{W_{\gamma,k}(t) dt}{t^2 + t + 1} + \sum_{k=1}^{\infty} \sum_{\substack{q_k \in I_{q,k} \\ q_{k+1} > 2Q}}^* \int_{t_k}^{t_{k-1}} \frac{W_{\gamma,k}(t) dt}{t^2 + t + 1}.$$

Employing (10.8) (which also holds for $k = 0$) and (5.6) we find

$$\mathbb{G}_{I,Q}^{(3.1)}(\xi) \cong \frac{c_I}{8\zeta(2)} \int_0^1 du \left(\int_{1-u}^{2-u} dw F^{(3.1.1)}(\xi; u, w) + \int_{2-u}^{\infty} dw F^{(3.1.2)}(\xi; u, w) \right), \quad (8.1)$$

where

$$F^{(3.1.1)}(\xi; u, w) = \frac{(w + u - 1)^2}{(w + u)^2 w} \cdot (w + u - \xi)_+ \wedge w,$$

$$F^{(3.1.2)}(\xi; u, v) = \frac{(1 - u)^2}{(w - u)^2 w} \cdot (w + u - \xi)_+ \wedge w.$$

8.1.2. $w_{\mathcal{A}_0} < w_{\mathcal{B}_k}$ ($\iff t > \gamma_{k+1}$) and $\xi Q < q_{k+1}$. In this case $k \geq 1$, $q_{k+1} \leq 2Q$, and

$$W_{\gamma,k}(t) = w_{\mathcal{A}_0}(t) \cdot (q_{k+1} - \xi Q)_+ \wedge q_k + (w_{\mathcal{B}_k}(t) - w_{\mathcal{A}_0}(t))q_k,$$

with contribution

$$\mathbb{G}_{I,Q}^{(3.2)}(\xi) = \sum_{k=1}^{\infty} \sum_{\substack{q_k \in I_{q,k} \\ \xi Q < q_{k+1} \leq 2Q}}^* \int_{\gamma_{k+1}}^{t_{k-1}} \frac{W_{\gamma,k}(t) dt}{t^2 + t + 1}.$$

Employing (11.1) and (12.2) we find

$$\mathbb{G}_{I,Q}^{(3.2)}(\xi) \cong \frac{c_I}{8\zeta(2)} \int_0^1 du \int_{(1 \vee (\xi - u)) \wedge (2 - u)}^{2 - u} dw F^{(3.2)}(\xi; u, w), \quad (8.2)$$

where

$$F^{(3.2)}(\xi; u, w) = \frac{2 - u - w}{(w - u)(w + u)} \left(\frac{w + u - 1}{w + u} + \frac{w - 1}{w - u} \right) \cdot (w + u - \xi)_+ \wedge w + \frac{(2 - u - w)^2 w}{(w - u)^2 (w + u)}.$$

8.1.3. $w_{\mathcal{B}_k} < w_{\mathcal{B}_{k+1}}$ ($\iff t > q_{k+1}$) and $q_{k+1} \leq \xi Q$. Again $k \geq 1$ and $q_{k+1} \leq 2Q$. Consider the integer N for which $q + Nq_k \leq \xi Q < q + (N + 1)q_k$, that is $1 \leq N = \left\lfloor \frac{\xi Q - q}{q_k} \right\rfloor \leq \xi$. Consider also $n_0 := \left\lfloor \frac{w_{\mathcal{B}_k} + w_{\mathcal{C}_k}}{w_{\mathcal{A}_0} + w_{\mathcal{C}_k}} \right\rfloor = \left\lfloor \frac{qt - a}{a_k - q_k t} \right\rfloor \geq 1$, and let

$$\lambda_{k,n} := \frac{a + na_k}{q + nq_k} \nearrow \gamma_k \quad \text{as } n \rightarrow \infty, \quad (8.3)$$

hence $\lambda_{k,n_0} \leq t < \lambda_{k,n_0+1}$ and $T(q + (n_0 + 1)q_k) < 0 \leq T(q + n_0q_k)$. The channel \mathcal{B}_k is locked exactly by the slits $q_{k+1} = q + q_k, \dots, q + n_0q_k, q + (n_0 + 1)q_k$ (see Figure 14) and $W_{\gamma,k}(t)$ is given by

$$\begin{cases} 0 & \text{if } N > n_0, \\ (w_{\mathcal{B}_k} + w_{\mathcal{C}_k} - n_0(w_{\mathcal{A}_0} + w_{\mathcal{C}_k}))(q + (n_0 + 1)q_k - \xi Q) & \text{if } n_0 = N, \\ (w_{\mathcal{A}_0} + w_{\mathcal{C}_k})(q + (N + 1)q_k - \xi Q) + (w_{\mathcal{B}_k} + w_{\mathcal{C}_k} - (N + 1)(w_{\mathcal{A}_0} + w_{\mathcal{C}_k}))q_k & \text{if } N < n_0, \end{cases}$$

or equivalently by

$$\begin{cases} 0 & \text{if } t \in I_{\gamma,k} \cap (t_k, \lambda_{k,N}], \\ W_{\gamma,k,N}^{(1)}(t) := (q_{k+1} + Nq_k - \xi Q)((q + Nq_k)t - a - Na_k) & \text{if } t \in I_{\gamma,k} \cap (\lambda_{k,N}, \lambda_{k,N+1}], \\ W_{\gamma,k}^{(2)}(t) := 1 - \xi Q(w_{\mathcal{A}_0}(t) + w_{\mathcal{C}_k}(t)) & \text{if } t \in I_{\gamma,k} \cap (\lambda_{k,N+1}, t_{k-1}]. \end{cases} \quad (8.4)$$

We shall start by keeping $N \geq 1$ and $q \leq Q$ fixed, and summing over

$$y = q_k \in \mathcal{J}_{q,N} := \left(\frac{\xi Q - q}{N + 1}, \frac{\xi Q - q}{N} \right].$$

Since $\lambda_{k,1} = \gamma_{k+1} > t_k$ and $\gamma_k > t_{k-1}$ for all k , nonzero contribution only arises from one of the following two subcases:

(I) $N(q_k - Q) \leq Q - q < (N + 1)(q_k - Q)$. Then $t_k < \gamma_{k+1} \leq \lambda_{k,N} \leq t_{k-1} < \lambda_{k,N+1}$ and the contribution is

$$\mathbb{G}_{I,Q}^{(3.3.1)}(\xi) = \sum_{1 \leq N \leq \xi} \sum_{k=1}^{\infty} \sum_{\substack{q_k \in \mathcal{I}_{q,k} \cap \mathcal{J}_{q,N} \\ Q + \frac{Q-q}{N+1} < q_k \leq Q + \frac{Q-q}{N}}}^* \int_{\lambda_{k,N}}^{t_{k-1}} \frac{W_{\gamma,k,N}^{(1)}(t) dt}{t^2 + t + 1}.$$

In this case N can only take the value $N = \left\lfloor \frac{Q-q}{q_k - Q} \right\rfloor$ for fixed k . Employing (12.3) we find

$$\mathbb{G}_{I,Q}^{(3.3.1)}(\xi) \cong \frac{c_I}{8\zeta(2)} \sum_{1 \leq N \leq \xi} \int_0^1 du \int_{[1 + \frac{1-u}{N+1}, 1 + \frac{1-u}{N}] \cap [\frac{\xi-u}{N+1}, \frac{\xi-u}{N}]} dw F_N^{(3.3.1)}(\xi; u, w), \quad (8.5)$$

where

$$F_N^{(3.3.1)}(\xi; u, w) = \frac{(1 - u - N(w - 1))^2 ((N + 1)w + u - \xi)}{(w - u)^2 (Nw + u)}.$$

(II) $(N + 1)(q_k - Q) \leq Q - q$. Then $t_k < \gamma_{k+1} \leq \lambda_{k,N} < \lambda_{k,N+1} \leq t_{k-1}$. The contribution

$$\mathbb{G}_{I,Q}^{(3.3.2)}(\xi) = \sum_{1 \leq N \leq \xi} \sum_{k=1}^{\infty} \sum_{\substack{q_k \in \mathcal{I}_{q,k} \cap \mathcal{J}_{q,N} \\ q_k \leq Q + \frac{Q-q}{N+1}}}^* \left(\int_{\lambda_{k,N}}^{\lambda_{k,N+1}} \frac{W_{\gamma,k,N}^{(1)}(t) dt}{t^2 + t + 1} + \int_{\lambda_{k,N+1}}^{t_{k-1}} \frac{W_{\gamma,k}^{(2)}(t) dt}{t^2 + t + 1} \right)$$

is estimated upon (12.4) and (12.7) as

$$\mathbb{G}_{I,Q}^{(3.3.2)}(\xi) \cong \frac{c_I}{8\zeta(2)} \sum_{1 \leq N \leq \xi} \int_0^1 du \int_{[1, 1 + \frac{1-u}{N+1}] \cap [\frac{\xi-u}{N+1}, \frac{\xi-u}{N}]} dw F_N^{(3.3.2)}(\xi; u, w), \quad (8.6)$$

where

$$F_N^{(3.3.2)}(\xi; u, w) = \frac{(N+1)w + u - \xi}{(Nw + u)((N+1)w + u)^2} + \frac{1-u - (N+1)(w-1)}{(w-u)((N+1)w + u)} \left(2 - \frac{\xi}{(N+1)w + u} - \frac{\xi(w-1)}{w-u} \right).$$

In this case $N \in \{\lfloor \xi \rfloor - 1, \lfloor \xi \rfloor\}$ suffices as a result of the inequality $\xi - u < N + 2 - u$.

8.2. The channel C_{\leftarrow} . In this case all slits $q + nq_k$ are removed, while slits $2q + nq_k$, $n \geq 0$, are not. Exactly two of the later ones lock $\mathcal{A}_0 \cup C_k$. Letting $n_0 := \lfloor \frac{w_{\mathcal{B}_k} + 2w_{C_k}}{w_{\mathcal{A}_0} + w_{C_k}} \rfloor = \lfloor \frac{a_{k-2} - 2\varepsilon - q_{k-2}t}{a_k - q_k t} \rfloor \geq 0$, we have $w_{\mathcal{B}_k} \leq T(2q + n_0q_k) = 2(w_{\mathcal{B}_k} + w_{C_k}) - n_0(w_{\mathcal{A}_0} + w_{C_k}) < 2\varepsilon$, so $\mathcal{A}_0 \cup C_k$ is locked exactly by the slits $2q + n_0q_k$ and $2q + (n_0 + 1)q_k$. The situation is described in Figure 15. Consider also

$$\mu_{k,n} := \frac{2a + na_k + 2\varepsilon}{2q + nq_k} \quad \text{and} \quad \nu_{k,n} := \frac{a + na_k}{q + nq_k}. \quad (8.7)$$

When $q_k \leq 2Q$, $\mu_{k,n} \nearrow \gamma_k > t_{k-1}$ as $n \rightarrow \infty$ and $\mu_{k,0} = \frac{a+\varepsilon}{q} \leq t_{k-1}$, $\forall k \geq 0$. We also have $\mu_{k,n_0-1} \leq t < \mu_{k,n_0}$ and the following two situations can arise:

(I) $w_{\mathcal{B}_k} \leq T(2q + n_0q_k) < w_{\mathcal{B}_k} + w_{C_k}$ ($\iff \mu_{k,n_0-1} \leq t < \nu_{k,n_0}$). Then $n_0 \geq 1$ and the widths of the relevant three sub-channels of $\mathcal{A}_0 \cup \mathcal{B}_k$ are (from bottom to top) $w_{\mathcal{A}_0}$, $w_{\mathcal{B}_k} + w_{C_k} - T(2q + n_0q_k) = a + n_0q_k - (q + n_0q_k)t$, $T(2q + n_0q_k) - w_{\mathcal{B}_k} = w_{C_k} - (a + n_0a_k - (q + n_0q_k)t)$, yielding

$$W_{\gamma,k}(t) = W_{\gamma,k,n_0}^{(1)}(t) = w_{\mathcal{A}_0}(t) \cdot (2q + n_0q_k - \xi Q)_+ \wedge q + w_{C_k}(t) \cdot (q_{k+2} + n_0q_k - \xi Q)_+ \wedge q_{k+1} - (a + n_0a_k - (q + n_0q_k)t) \cdot ((q_{k+2} + n_0q_k - \xi Q)_+ \wedge q_{k+1} - (2q + n_0q_k - \xi Q)_+ \wedge q_{k+1}).$$

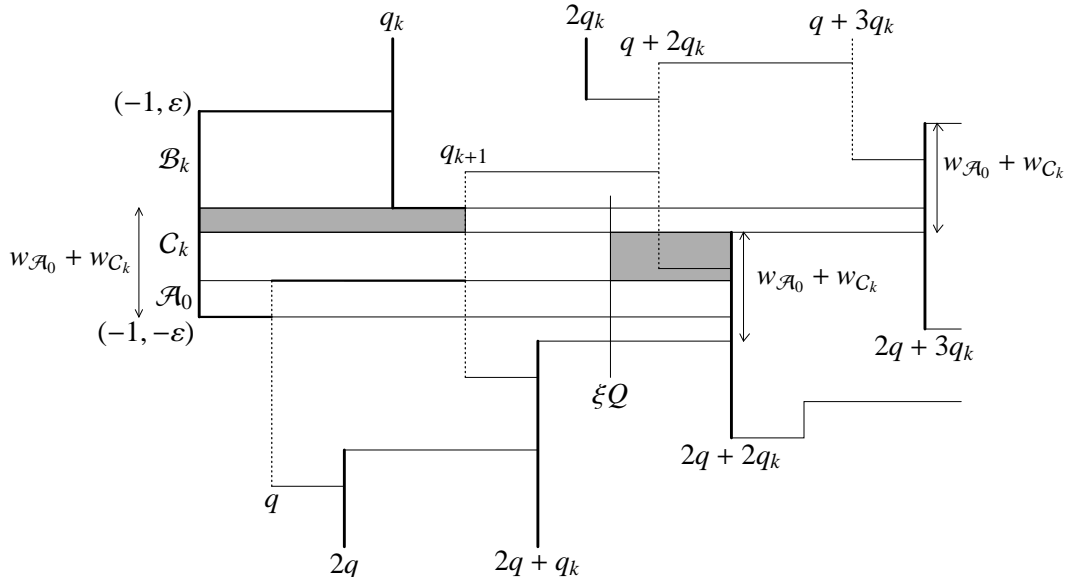

FIGURE 15. The case $t \in I_{\gamma,k}$, $r = 1$, $r_k = 0$, $r_{k+1} = -1$, C_{\leftarrow} , $n_0 = 2$

(II) $w_{\mathcal{B}_k} + w_{\mathcal{C}_k} \leq T(2q + n_0q_k) < 2\varepsilon$ ($\iff v_{k,n_0} \leq t < \mu_{k,n_0}$). Then $n_0 \geq 0$ and the widths of the relevant three sub-channels of $\mathcal{A}_0 \cup \mathcal{C}_k$ are: $2\varepsilon - T(2q + n_0q_k) = w_{\mathcal{A}_0} - ((q + n_0q_k)t - a - n_0q_k)$, $T(2q + n_0q_k) - (w_{\mathcal{B}_k} + w_{\mathcal{C}_k}) = (q + n_0q_k)t - a - n_0a_k$, $w_{\mathcal{C}_k}$, yielding

$$W_{\gamma,k}(t) = W_{\gamma,k,n_0}^{(2)}(t) = w_{\mathcal{A}_0}(t) \cdot (2q + n_0q_k - \xi Q)_+ \wedge q + w_{\mathcal{C}_k}(t) \cdot (q_{k+2} + n_0q_k - \xi Q)_+ \wedge q_{k+1} \\ + ((q + n_0q_k)t - a - n_0a_k) \cdot ((q_{k+2} + n_0q_k - \xi Q)_+ \wedge q - (2q + n_0q_k - \xi Q)_+ \wedge q).$$

The following three cases arise:

8.2.1. $n_0 = 0$ ($\iff t < \frac{a+\varepsilon}{q}$). In this case \mathcal{A}_0 is locked by the slits $2q$ and q_{k+2} . One sees that $W_{\gamma,k}(t) = W_{\gamma,k,0}^{(2)}(t)$. When $q_{k+2} \leq 2Q$ we have $\frac{a+\varepsilon}{q} < t_k$ with zero contribution, so we must take $q_{k+1} > 2Q - q$. When $q_{k+1} > 2Q$ we have $k \geq 1$ and $\frac{a+\varepsilon}{q} > t_{k-1}$, with contribution

$$\mathbb{G}_{I,Q}^{(3.4.1)}(\xi) = \sum_{k=1}^{\infty} \sum_{\substack{q_k \in \mathcal{I}_{q,k} \\ q_{k+1} > 2Q}}^* \int_{t_k}^{t_{k-1}} \frac{W_{\gamma,k,0}^{(2)}(t) dt}{t^2 + t + 1}.$$

Employing (5.6), (5.7), (5.9) and $qt - a = w_{\mathcal{B}_k}(t) + w_{\mathcal{C}_k}(t)$ we find

$$\mathbb{G}_{I,Q}^{(3.4.1)}(\xi) \cong \frac{c_I}{8\zeta(2)} \int_0^1 du \int_{2-u}^{\infty} dw F^{(3.4.1)}(\xi; u, w), \quad (8.8)$$

where

$$F^{(3.4.1)}(\xi; u, w) = \frac{(1-u)^2(2w-u)}{(w-u)^2w^2} \cdot ((w+2u-\xi)_+ \wedge u - (2u-\xi)_+ \wedge u) \\ + \frac{1-u}{(w-u)w} \left(\frac{w+u-1}{w} + \frac{w-1}{w-u} \right) \cdot (2u-\xi)_+ \wedge u + \frac{(1-u)^2}{(w-u)w^2} \cdot (w+2u-\xi)_+ \wedge (w+u).$$

When $2Q - q < q_{k+1} \leq 2Q$ we have $t_k < \frac{a+\varepsilon}{q} \leq t_{k-1}$ and q_k takes exactly one value. The corresponding contribution

$$\mathbb{G}_{I,Q}^{(3.4.2)}(\xi) = \sum_{k=0}^{\infty} \sum_{\substack{q_k \in \mathcal{I}_{q,k} \\ 2Q-q < q_{k+1} \leq 2Q}}^* \int_{t_k}^{\frac{a+\varepsilon}{q}} \frac{W_{\gamma,k,0}^{(2)}(t) dt}{t^2 + t + 1}$$

is estimated upon (10.11), (10.12), (10.15), (10.16) as

$$\mathbb{G}_{I,Q}^{(3.4.2)}(\xi) \cong \frac{c_I}{8\zeta(2)} \int_0^1 du \int_{2-2u}^{2-u} dw F^{(3.4.2)}(\xi; u, w), \quad (8.9)$$

where

$$F^{(3.4.2)}(\xi; u, w) = \frac{w+2u-2}{2uw} \left(\frac{1-u}{w} + \frac{2-u-w}{2u} \right) \cdot (w+2u-\xi)_+ \wedge (w+u) \\ + \frac{(w+2u-2)(w-2u+2)}{4uw^2} \cdot (w+2u-\xi)_+ \wedge u + \frac{(w+2u-2)^2}{2uw^2} \cdot (2u-\xi)_+ \wedge u.$$

8.2.2. $n_0 \geq 1$ and $k = 0$. Then $\mu_{0,1} = \frac{2a'+a+2\varepsilon}{2q+q'} > \gamma_1 = t_{-1} = \nu_{0,1} > \frac{a+\varepsilon}{q}$, with contribution

$$\mathbb{G}_{I,Q}^{(3.4.3)}(\xi) = \sum_{\substack{q > Q/2 \\ q' > 2(Q-q)}}^* \int_{\frac{a+\varepsilon}{q}}^{\gamma_1} \frac{W_{\gamma,0,1}^{(1)}(t) dt}{t^2 + t + 1}.$$

Employing (12.8), (12.9), (12.10) we find

$$\mathbb{G}_{I,Q}^{(3.4.3)}(\xi) \cong \frac{c_I}{8\zeta(2)} \int_{\frac{1}{2}}^1 du \int_{2-2u}^1 dw F^{(3.4.3)}(\xi; u, w), \quad (8.10)$$

where

$$\begin{aligned} F^{(3.4.3)}(\xi; u, w) &= \frac{(2-u-w)(3w+3u-2)}{4u(w+u)^2} \cdot (w+2u-\xi)_+ \wedge u \\ &+ \frac{(2-u-w)^2}{2u(w+u)^2} \cdot (2w+2u-\xi)_+ \wedge (w+u) + \frac{(2-u-w)^2}{4u^2(w+u)} \cdot (w+2u-\xi)_+ \wedge (w+u). \end{aligned}$$

8.2.3. $n_0 \geq 1$ and $k \geq 1$. Note first that $\mu_{k,n} \leq t_k$ when $q_k \leq \frac{2(Q-q)}{n+1}$ and $t_{k-1} < \mu_{k,n-1}$ when $q_k > Q + \frac{Q-q}{n}$. In both cases $I_{\gamma,k} \cap [\mu_{k,n-1}, \mu_{k,n}]$ has measure zero, so we shall only consider $q_k \in \left[\frac{2(Q-q)}{n+1}, Q + \frac{Q-q}{n} \right]$. The following four subcases arise:

(I) $\frac{2(Q-q)}{n+1} < q_k \leq \frac{2(Q-q)}{n} \wedge \left(Q + \frac{Q-q}{n+1} \right)$. Since $q_k > Q$ we have $Q \leq \frac{2(Q-q)}{n}$, so $n = 1$ and $q \leq \frac{Q}{2}$. Furthermore $\mu_{k,0} < t_k < \nu_{k,1} < \mu_{k,1} < t_{k-1}$ and the contribution is

$$\mathbb{G}_{I,Q}^{(3.4.4)}(\xi) = \sum_{k=1}^{\infty} \sum_{\substack{q_k \in \mathcal{I}_{q,k}, q \leq Q/2 \\ q_k \leq 2(Q-q) \wedge \frac{3Q-q}{2}}}^* \left(\int_{t_k}^{\nu_{k,1}} \frac{W_{\gamma,k,1}^{(1)}(t) dt}{t^2 + t + 1} + \int_{\nu_{k,1}}^{\mu_{k,1}} \frac{W_{\gamma,k,1}^{(2)}(t) dt}{t^2 + t + 1} \right).$$

Employing (12.11)-(12.14) we find

$$\begin{aligned} \mathbb{G}_{I,Q}^{(3.4.4)}(\xi) &\cong \frac{c_I}{8\zeta(2)} \int_0^{\frac{1}{3}} du \int_1^{\frac{3-u}{2}} dw F^{(3.4.4)}(\xi; u, w) \\ &+ \frac{c_I}{8\zeta(2)} \int_{\frac{1}{3}}^{\frac{1}{2}} du \int_1^{2-2u} dw F^{(3.4.4)}(\xi; u, w), \end{aligned} \quad (8.11)$$

where

$$\begin{aligned} F^{(3.4.4)}(\xi; u, w) &= \frac{(w+u-1)^2(3w+2u)}{w^2(w+u)(w+2u)} \cdot (w+2u-\xi)_+ \wedge u \\ &+ \left\{ \frac{2(w+u-1)}{w(w+2u)} \left(\frac{1-u}{w} + \frac{3-u-2w}{w+2u} \right) - \frac{(w+u-1)^2}{w^2(w+u)} \right\} \cdot (2w+2u-\xi)_+ \wedge (w+u) \\ &+ \frac{(w+u-1)^2}{w^2(w+u)} \cdot (w+2u-\xi)_+ \wedge (w+u) + \frac{(w+u-1)^2}{(w+u)(w+2u)^2} \cdot (2w+2u-\xi)_+ \wedge u. \end{aligned}$$

(II) $\frac{2(Q-q)}{n} < q_k \leq Q + \frac{Q-q}{n+1}$. Then $t_k < \mu_{k,n-1} < \nu_{k,n} < \mu_{k,n} \leq t_{k-1}$, with contribution

$$\mathbb{G}_{I,Q}^{(3,4,5)}(\xi) = \sum_{k=1}^{\infty} \sum_{n=1}^{\infty} \sum_{\substack{q_k \in \mathcal{I}_{q,k} \\ \frac{2(Q-q)}{n} < q_k \leq Q + \frac{Q-q}{n+1}}}^* \left(\int_{\mu_{k,n-1}}^{\nu_{k,n}} \frac{W_{\gamma,k,n}^{(1)}(t) dt}{t^2 + t + 1} + \int_{\nu_{k,n}}^{\mu_{k,n}} \frac{W_{\gamma,k,n}^{(2)}(t) dt}{t^2 + t + 1} \right).$$

Employing (12.15)-(12.19) we find (according to whether $n = 1$ or $n \geq 2$)⁷

$$\begin{aligned} \mathbb{G}_{I,Q}^{(3,4,5)}(\xi) &\approx \frac{c_I}{8\zeta(2)} \int_{\frac{1}{3}}^{\frac{1}{2}} du \int_{2-2u}^{\frac{3-u}{2}} dw F_1^{(3,4,5)}(\xi; u, w) \\ &\quad + \frac{c_I}{8\zeta(2)} \int_{\frac{1}{2}}^1 du \int_u^{\frac{3-u}{2}} dw F_1^{(3,4,5)}(\xi; u, w) \\ &\quad + \frac{c_I}{8\zeta(2)} \sum_{n=2}^{\infty} \int_0^1 du \int_1^{1+\frac{1-u}{n+1}} dw F_n^{(3,4,5)}(\xi; u, w), \end{aligned} \tag{8.12}$$

where

$$\begin{aligned} F_n^{(3,4,5)}(\xi; u, w) &= \frac{(n(w-1) + u)^2}{(nw + u)(nw + 2u)^2} \cdot ((n+1)w + 2u - \xi)_+ \wedge u \\ &\quad + \frac{(1-u - n(w-1))^2}{(nw + u)((n-1)w + 2u)^2} \cdot (nw + 2u - \xi)_+ \wedge (w + u) \\ &\quad + \left\{ \frac{2-w}{(nw + 2u)((n-1)w + 2u)} \left(\frac{(n-1)(w-1) + u}{(n-1)w + 2u} + \frac{n(w-1) + u}{nw + 2u} \right) - \frac{(n(w-1) + u)^2}{(nw + u)(nw + 2u)^2} \right\} \\ &\quad \cdot (nw + 2u - \xi)_+ \wedge u \\ &\quad + \left\{ \frac{2-w}{(nw + 2u)((n-1)w + 2u)} \left(\frac{1-u - n(w-1)}{(n-1)w + 2u} + \frac{1-u - (n+1)(w-1)}{nw + 2u} \right) \right. \\ &\quad \left. - \frac{(1-u - n(w-1))^2}{(nw + u)((n-1)w + 2u)^2} \right\} \cdot ((n+1)w + 2u - \xi)_+ \wedge (w + u). \end{aligned}$$

(III) $Q + \frac{Q-q}{n+1} < q_k \leq \frac{2(Q-q)}{n}$. This gives $n = 1$, $\mu_{k,0} \leq t_k < \nu_{k,1} = \gamma_{k+1} < t_{k-1} < \mu_{k,1}$, and

$$\mathbb{G}_{I,Q}^{(3,4,6)}(\xi) = \sum_{k=1}^{\infty} \sum_{\substack{q_k \in \mathcal{I}_{q,k} \\ \frac{3Q-q}{2} < q_k \leq 2(Q-q)}}^* \left(\int_{t_k}^{\nu_{k,1}} \frac{W_{\gamma,k,n}^{(1)}(t) dt}{t^2 + t + 1} + \int_{\nu_{k,1}}^{t_{k-1}} \frac{W_{\gamma,k,n}^{(2)}(t) dt}{t^2 + t + 1} \right).$$

Employing (5.7), (5.9), (10.9) and (12.20) we find

$$\mathbb{G}_{I,Q}^{(3,4,6)}(\xi) \approx \frac{c_I}{8\zeta(2)} \int_0^{\frac{1}{3}} du \int_{\frac{3-u}{2}}^{2-2u} dw F^{(3,4,6)}(\xi; u, w), \tag{8.13}$$

⁷Note that $2(Q-q) < q_k \leq Q + \frac{Q-q}{n+1}$ implies $q > \frac{Q}{3}$.

where

$$\begin{aligned}
F^{(3.4.6)}(\xi; u, w) &= \left\{ \frac{1-u}{(w-u)w} \left(\frac{w+u-1}{w} + \frac{w-1}{w-u} \right) - \frac{(2-w-u)^2}{(w-u)^2(w+u)} \right\} \cdot (w+2u-\xi)_+ \wedge u \\
&+ \left\{ \frac{(1-u)^2}{(w-u)w^2} - \frac{(w+u-1)^2}{(w+u)w^2} \right\} \cdot (2w+2u-\xi)_+ \wedge (w+u) \\
&+ \frac{(w+u-1)^2}{(w+u)w^2} \cdot (w+2u-\xi)_+ \wedge (w+u) + \frac{(2-w-u)^2}{(w-u)^2(w+u)} \cdot (2w+2u-\xi)_+ \wedge u.
\end{aligned}$$

(IV) $\frac{2(Q-q)}{n} \vee \left(Q + \frac{Q-q}{n+1} \right) < q_k \leq Q + \frac{Q-q}{n}$. For fixed k there is only one value n can take, namely $\left\lfloor \frac{Q-q}{q_k-Q} \right\rfloor$. We have $t_k < \mu_{k,n-1} \leq \nu_{k,n} \leq t_{k-1} < \mu_{k,n}$ and

$$\mathbb{G}_{I,Q}^{(3.4.7)}(\xi) = \sum_{k=1}^{\infty} \sum_{n=1}^{\infty} \sum_{\substack{q_k \in \mathcal{I}_{q,k} \\ \frac{2(Q-q)}{n} \vee \left(Q + \frac{Q-q}{n+1} \right) < q_k \leq Q + \frac{Q-q}{n}}}^* \left(\int_{\mu_{k,n-1}}^{\nu_{k,n}} \frac{W_{\gamma,k,n}^{(1)}(t) dt}{t^2 + t + 1} + \int_{\nu_{k,n}}^{t_{k-1}} \frac{W_{\gamma,k,n}^{(2)}(t) dt}{t^2 + t + 1} \right).$$

Employing (12.21)-(12.25) we find

$$\begin{aligned}
\mathbb{G}_{I,Q}^{(3.4.7)}(\xi) &\cong \frac{c_I}{8\zeta(2)} \int_0^{\frac{1}{3}} du \int_{2-2u}^{2-u} dw F_1^{(3.4.7)}(\xi; u, w) \\
&+ \frac{c_I}{8\zeta(2)} \int_{\frac{1}{3}}^1 du \int_{\frac{3-u}{2}}^{2-u} dw F_1^{(3.4.7)}(\xi; u, w) \\
&+ \frac{c_I}{8\zeta(2)} \sum_{n=2}^{\infty} \int_0^1 du \int_{1+\frac{1-u}{n+1}}^{1+\frac{1-u}{n}} dw F_n^{(3.4.7)}(\xi; u, w),
\end{aligned} \tag{8.14}$$

where

$$\begin{aligned}
F_n^{(3.4.7)}(\xi; u, w) &= \frac{(1-u-n(w-1))^2}{(w-u)(nw+2u)((n-1)w+2u)} \cdot ((n+1)w+2u-\xi)_+ \wedge (w+u) \\
&+ \left\{ \frac{1-u-n(w-1)}{(w-u)((n-1)w+2u)} \left(\frac{(n-1)(w-1)+u}{(n-1)w+2u} + \frac{w-1}{w-u} \right) - \frac{(1-u-n(w-1))^2}{(w-u)^2(nw+u)} \right\} \\
&\quad \cdot (nw+2u-\xi)_+ \wedge u \\
&+ \frac{(1-u-n(w-1))^2}{(nw+u)((n-1)w+2u)^2} \cdot (nw+2u-\xi)_+ \wedge (w+u) \\
&+ \frac{(1-u-n(w-1))^2}{(w-u)^2(nw+u)} \cdot ((n+1)w+2u-\xi)_+ \wedge u.
\end{aligned}$$

9. CHANNELS WITH REMOVED SLITS. THE CASE $r_{k+1} = 0$

In this section we consider

$$\sum^* = \sum_{\substack{\gamma \in \mathcal{F}_1(Q) \\ q \not\equiv a \pmod{3} \\ q_{k+1} \equiv a_{k+1} \pmod{3}}} .$$

We shall actually sum as in Remark 1 of Section 5 over $x = q - a \in q(1 - I)$, $x \equiv \pm 1 \pmod{3}$, $y = q_{k+1} \in I_{q,k+1}$, $\beta = 0$, $xy \equiv 1 \pmod{3q}$. The contributions arising from $x \equiv 1 \pmod{3}$ respectively $x \equiv -1 \pmod{3}$ will have the same main term and error.

9.1. The channel C_O . In the formulas for C_O and $(r, r_k) = (1, -1)$, respectively $(r, r_k) = (-1, 1)$, the corresponding main term and error coincide. Hence we only take $(r, r_k, r_{k+1}) = (1, -1, 0)$ and double its C_O contribution. The slits $q + \ell q_{k+1}$, $\ell \geq 1$, are not removed and lock the channel C_k (see Figure 16). The following two situations arise:

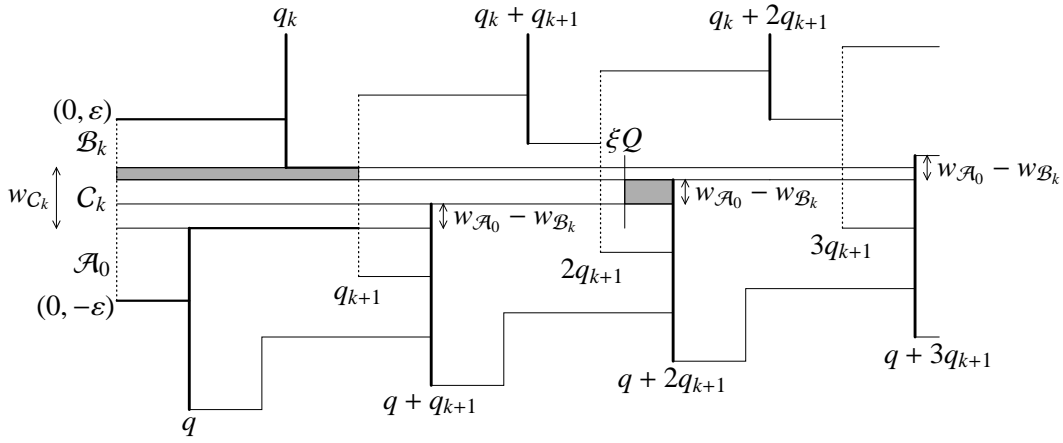

FIGURE 16. The case $t \in I_{\gamma,k}$, $r = \pm 1$, $r_k = \mp 1$, $r_{k+1} = 0$, C_O , $w_{\mathcal{A}_0} > w_{\mathcal{B}_k}$, $N = 1$, $n_0 = 2$

9.1.1. $w_{\mathcal{A}_0} > w_{\mathcal{B}_k}$ ($\iff t < \gamma_{k+1}$). We split the analysis in the following two cases:

(I) $\xi Q < q_{k+2}$. Then (since $w_{\mathcal{A}_0} - w_{\mathcal{B}_k} > w_{C_k} \iff t < \frac{a+\varepsilon}{q}$) we find

$$W_{\gamma,k}(t) = \begin{cases} W_{\gamma,k}^{(1)}(t) := w_{C_k}(t) \cdot (q_{k+2} - \xi Q) \wedge q_{k+1} & \text{if } t < \frac{a+\varepsilon}{q}, \\ W_{\gamma,k}^{(2)}(t) := ((w_{\mathcal{A}_0}(t) - w_{\mathcal{B}_k}(t)) \cdot (q_{k+2} - \xi Q) \wedge q_{k+1} \\ \quad + (w_{C_k}(t) - w_{\mathcal{A}_0}(t) + w_{\mathcal{B}_k}(t))q_{k+1} & \text{if } t \geq \frac{a+\varepsilon}{q}. \end{cases}$$

• When $q_{k+1} > 2Q$ we have $k \geq 1$ and $t_{k-1} < \gamma_{k+1} < \frac{a+\varepsilon}{q}$. with contribution

$$\mathbb{G}_{I,Q}^{(4.1.1.1)}(\xi) = \sum_{k=1}^{\infty} \sum_{\substack{q_{k+1} \in I_{q,k+1} \\ q_{k+1} > (\xi Q - q) \vee 2Q}}^* \int_{t_k}^{t_{k-1}} W_{\gamma,k}^{(1)}(t) dt$$

estimated upon (5.7) as

$$\mathbb{G}_{I,Q}^{(4.1.1.1)}(\xi) \cong \frac{c_I}{8\xi(2)} \int_0^1 du \int_{2\sqrt{(\xi-u)\vee(1+u)}}^{\infty} dw \frac{(1-u)^2}{(w-2u)(w-u)^2} \cdot (w+u-\xi)_+ \wedge w. \quad (9.1)$$

• When $q_{k+1} \leq 2Q$ we have $\frac{a+\varepsilon}{q} \leq \gamma_{k+1} \leq t_{k-1}$ and $t_k < \frac{a+\varepsilon}{q} \iff q_{k+2} > 2Q$ for all $k \geq 0$. In this case the contribution

$$\begin{aligned} \mathbb{G}_{I,Q}^{(4.1.1.2)}(\xi) &= \sum_{k=0}^{\infty} \sum_{\substack{q_{k+1} \in \mathcal{I}_{q,k+1} \\ 2Q \geq q_{k+1} > (\xi \vee 2)Q - q}}^* \left(\int_{t_k}^{\frac{a+\varepsilon}{q}} W_{\gamma,k}^{(1)}(t) dt + \int_{\frac{a+\varepsilon}{q}}^{\gamma_{k+1}} W_{\gamma,k}^{(2)}(t) dt \right) \\ &\quad + \sum_{k=0}^{\infty} \sum_{\substack{q_{k+1} \in \mathcal{I}_{q,k+1} \\ 2Q - q \geq q_{k+1} > \xi Q - q}}^* \int_{t_k}^{\gamma_{k+1}} W_{\gamma,k}^{(2)}(t) dt \end{aligned}$$

is estimated upon (10.15), (10.16), (10.18) (which also holds for $k = 0$), (10.9), (10.20), (13.1), (5.4), as

$$\begin{aligned} \mathbb{G}_{I,Q}^{(4.1.1.2)}(\xi) &\cong \frac{c_I}{8\zeta(2)} \int_0^1 du \int_{(\xi \vee 2 - u) \wedge 2}^2 dw F^{(4.1.1.2.1)}(\xi; u, w) \\ &\quad + \frac{c_I}{8\zeta(2)} \int_0^1 du \int_{((\xi - u) \vee 1) \wedge (2 - u)}^{2 - u} dw F^{(4.1.1.2.2)}(\xi; u, w), \end{aligned} \tag{9.2}$$

where

$$\begin{aligned} F^{(4.1.1.2.1)}(\xi; u, w) &= \left(\frac{w+u-2}{2u(w-u)} \left(\frac{1-u}{w-u} + \frac{2-w}{2u} \right) + \frac{(2-w)^2}{4u^2w} \right) \cdot (w+u-\xi) \wedge w + \frac{(2-w)^2}{2uw}, \\ F^{(4.1.1.2.2)}(\xi; u, w) &= \frac{w-1}{w-u} \left(\frac{2-u-w}{w-u} + \frac{2-w}{w} \right) + \frac{(w-1)^2}{(w-u)^2w} \cdot (w+u-\xi) \wedge w. \end{aligned}$$

(II) $\xi Q \geq q_{k+2}$. Let N be the unique integer for which $q + Nq_{k+1} \leq \xi Q < q + (N+1)q_{k+1} = q_{k+2} + Nq_{k+1}$, that is $1 \leq N := \lfloor \frac{\xi Q - q}{q_{k+1}} \rfloor \leq \xi$. The corresponding range of q_{k+1} is

$$y = q_{k+1} \in \mathcal{J}_{q,N} := \left(\frac{\xi Q - q}{N+1}, \frac{\xi Q - q}{N} \right].$$

We take $n_0 := \lfloor \frac{w_{C_k}}{w_{\mathcal{A}_0} - w_{\mathcal{B}_k}} \rfloor = \lfloor \frac{a_{k-1} - 2\varepsilon - q_{k-1}t}{a_{k+1} - q_{k+1}t} \rfloor \geq 1$. Then $t \geq \frac{a+\varepsilon}{q}$. We only need $\frac{a+\varepsilon}{q} \leq \gamma_{k+1}$, that is $q_{k+1} \leq 2Q$. In this case we take

$$\lambda_{k,n} := \frac{na_{k+1} - a_{k-1} + 2\varepsilon}{nq_{k+1} - q_{k-1}} \nearrow \gamma_{k+1} \leq t_{k-1} \quad \text{as } n \rightarrow \infty, \tag{9.3}$$

hence $\lambda_{k,n_0} \leq t < \lambda_{k,n_0+1}$ and $T(q + n_0q_{k+1}) = w_{\mathcal{B}_k} + w_{C_k} - n_0(w_{\mathcal{A}_0} - w_{\mathcal{B}_k}) \geq w_{\mathcal{B}_k} > T(q + (n_0+1)q_{k+1})$. This shows that C_k is locked by the slits $q + q_{k+1}, \dots, q + (n_0+1)q_{k+1}$ and $W_{\gamma,k}(t) = W_{\gamma,k,N}(t)$ is given by

$$\begin{aligned} &\begin{cases} 0 & \text{if } n_0 < N, \\ (w_{C_k} - N(w_{\mathcal{A}_0} - w_{\mathcal{B}_k}))(q + (N+1)q_{k+1} - \xi Q) & \text{if } n_0 = N, \\ (w_{\mathcal{A}_0} - w_{\mathcal{B}_k})(q + (N+1)q_{k+1} - \xi Q) + (w_{C_k} - (N+1)(w_{\mathcal{A}_0} - w_{\mathcal{B}_k}))q_{k+1} & \text{if } n_0 > N, \end{cases} \\ &= \begin{cases} 0 & \text{if } t \in I_{\gamma,k} \cap (\gamma, \lambda_{k,N}], \\ W_{\gamma,k,N}^{(1)}(t) := (q + (N+1)q_{k+1} - \xi Q) & \\ \quad \cdot ((Nq_{k+1} - q_{k-1})t - Na_{k+1} + a_{k-1} - 2\varepsilon) & \text{if } t \in I_{\gamma,k} \cap (\lambda_{k,N}, \lambda_{k,N+1}], \\ W_{\gamma,k}^{(2)}(t) := w_{C_k}(t)q_{k+1} - (w_{\mathcal{A}_0}(t) - w_{\mathcal{B}_k}(t))(\xi Q - q) & \text{if } t \in I_{\gamma,k} \cap (\lambda_{k,N+1}, \gamma_{k+1}]. \end{cases} \end{aligned}$$

The following three subcases arise:

(II₁) $q_{k+1} \leq Q + \frac{Q-q}{N+1}$. Then $\lambda_{k,N+1} \leq t_k$, $W_{\gamma,k}(t) = W_{\gamma,k}^{(2)}(t)$, $\forall t \in (t_k, \gamma_{k+1}]$, with contribution

$$\mathbb{G}_{I,Q}^{(4.1.2)}(\xi) = \sum_{1 \leq N \leq \xi} \sum_{k=0}^{\infty} \sum_{\substack{q \leq \xi Q \\ q_{k+1} \in \mathcal{I}_{q,k+1} \cap \mathcal{J}_{q,N} \\ q_{k+1} \leq Q + \frac{Q-q}{N+1}}}^* \int_{t_k}^{\gamma_{k+1}} \frac{W_{\gamma,k}^{(2)}(t) dt}{t^2 + t + 1}.$$

Employing (5.4), (13.1), (10.9) (which also holds for $k = 0$) we find

$$\mathbb{G}_{I,Q}^{(4.1.2)}(\xi) \cong \frac{c_I}{8\zeta(2)} \sum_{1 \leq N \leq \xi} \int_0^{\xi \wedge 1} du \int_{[1, 1 + \frac{1-u}{N+1}] \cap [\frac{\xi-u}{N+1}, \frac{\xi-u}{N}]} dw F^{(4.1.2)}(\xi; u, w), \quad (9.4)$$

where

$$F^{(4.1.2)}(\xi; u, w) = \frac{w-1}{w-u} \left(\frac{1-u}{w-u} + \frac{2-w}{w} \right) - \frac{(w-1)^2(\xi-u)}{(w-u)^2 w}.$$

(II₂) $Q + \frac{Q-q}{N+1} < q_{k+1} \leq Q + \frac{Q-q}{N}$. In this case $\lambda_{k,N} \leq t_k < \lambda_{k,N+1}$. The contribution

$$\mathbb{G}_{I,Q}^{(4.1.3)}(\xi) = \sum_{1 \leq N \leq \xi} \sum_{k=0}^{\infty} \sum_{\substack{q \leq \xi Q \\ q_{k+1} \in \mathcal{I}_{q,k+1} \cap \mathcal{J}_{q,N} \\ Q + \frac{Q-q}{N+1} < q_{k+1} \leq Q + \frac{Q-q}{N}}}^* \left(\int_{t_k}^{\lambda_{k,N+1}} \frac{W_{\gamma,k,N}^{(1)}(t) dt}{t^2 + t + 1} + \int_{\lambda_{k,N+1}}^{\gamma_{k+1}} \frac{W_{\gamma,k}^{(2)}(t) dt}{t^2 + t + 1} \right)$$

is estimated upon (13.4), (13.5), (13.6), (13.9) as

$$\mathbb{G}_{I,Q}^{(4.1.3)}(\xi) \cong \frac{c_I}{8\zeta(2)} \sum_{1 \leq N \leq \xi} \int_0^{\xi \wedge 1} du \int_{[1 + \frac{1-u}{N+1}, 1 + \frac{1-u}{N}] \cap [\frac{\xi-u}{N+1}, \frac{\xi-u}{N}]} dw F_N^{(4.1.3)}(\xi; u, w), \quad (9.5)$$

where

$$F_N^{(4.1.3)}(\xi; u, w) = \frac{(2-w)^2((2N+1)w + 3u - \xi)}{(Nw + 2u)^2 w} + \frac{((N+1)(w-1) + u - 1)((N+1)w + u - \xi)}{(w-u)(Nw + 2u)} \left(\frac{2-w}{Nw + 2u} + \frac{1-u - N(w-1)}{w-u} \right).$$

(II₃) $Q + \frac{Q-q}{N} < q_{k+1} \leq 2Q$. In this case $t_k < \lambda_{k,N}$. The contribution

$$\mathbb{G}_{I,Q}^{(4.1.4)}(\xi) = \sum_{1 \leq N \leq \xi} \sum_{k=0}^{\infty} \sum_{\substack{q \leq \xi Q \\ q_{k+1} \in \mathcal{I}_{q,k+1} \cap \mathcal{J}_{q,N} \\ Q + \frac{Q-q}{N} < q_{k+1} \leq 2Q}}^* \left(\int_{\lambda_{k,N}}^{\lambda_{k,N+1}} \frac{W_{\gamma,k,N}^{(1)}(t) dt}{t^2 + t + 1} + \int_{\lambda_{k,N+1}}^{\gamma_{k+1}} \frac{W_{\gamma,k}^{(2)}(t) dt}{t^2 + t + 1} \right)$$

is estimated upon (13.4)-(13.7) as

$$\mathbb{G}_{I,Q}^{(4.1.4)}(\xi) \cong \frac{c_I}{8\zeta(2)} \sum_{1 \leq N \leq \xi} \int_0^{\xi \wedge 1} du \int_{[1 + \frac{1-u}{N}, 2] \cap [\frac{\xi-u}{N+1}, \frac{\xi-u}{N}]} dw F_N^{(4.1.4)}(\xi; u, w), \quad (9.6)$$

where

$$F_N^{(4.1.4)}(\xi; u, w) = \frac{(2-w)^2}{(Nw + 2u)^2} \left(\frac{(N+1)w + u - \xi}{(N-1)w + 2u} + \frac{(2N+1)w + 3u - \xi}{w} \right).$$

9.1.2. $w_{\mathcal{A}_0} < w_{\mathcal{B}_k}$ ($\iff t > \gamma_{k+1}$). In this situation $k \geq 1$ and $\gamma_{k+1} \leq t_{k-1}$, so $q_{k+1} \leq 2Q$. Two cases arise:

(I) $\xi Q < q_k$. Then $W_{\gamma,k}(t) = w_{C_k}(t)q_{k+1}$, $\forall t \in (\gamma_{k+1}, t_{k-1}]$, with contribution

$$\mathbb{G}_{I,Q}^{(4.2.1)}(\xi) = \sum_{k=1}^{\infty} \sum_{q+\xi Q < q_{k+1} \leq 2Q}^* \int_{\gamma_{k+1}}^{t_{k-1}} \frac{W_{\gamma,k}(t) dt}{t^2 + t + 1}.$$

Employing (12.1) we find

$$\mathbb{G}_{I,Q}^{(4.2.1)}(\xi) \cong \frac{c_I}{8\zeta(2)} \int_0^1 du \int_{2\wedge(u+\xi v)}^2 dw \frac{(2-w)^2}{(w-2u)w}. \quad (9.7)$$

(II) $\xi Q \geq q_k$. Consider the unique integer $0 \leq N = \lfloor \frac{\xi Q - q_k}{q_{k+1}} \rfloor \leq \xi$ for which $q_k + Nq_{k+1} < \xi Q \leq q_k + (N+1)q_{k+1} = q_{k+2} + Nq_{k+1}$, so the range of q_{k+1} is

$$y = q_{k+1} \in \mathcal{J}_{q,N} := \left(\frac{\xi Q + q}{N+2}, \frac{\xi Q + q}{N+1} \right].$$

This time we take $n_0 := \lfloor \frac{w_{C_k}}{w_{\mathcal{B}_k} - w_{\mathcal{A}_0}} \rfloor = \lfloor \frac{a_{k-1} - 2\varepsilon - q_{k-1}t}{q_{k+1}t - a_{k+1}} \rfloor \geq 0$ and

$$\lambda_{k,n} := \frac{na_{k+1} + a_{k-1} - 2\varepsilon}{nq_{k+1} + q_{k-1}} \searrow \gamma_{k+1} > t_k \quad \text{as } n \rightarrow \infty, \quad (9.8)$$

hence $\lambda_{k,n_0+1} < t \leq \lambda_{k,n_0}$ and $B(q_k + n_0q_{k+1}) = w_{\mathcal{B}_k} + n_0(w_{\mathcal{B}_k} - w_{\mathcal{A}_0}) \leq w_{\mathcal{B}_k} + w_{C_k} < B(q_k + (n_0+1)q_{k+1})$. This shows that C_k is locked by the slits $q_k + q_{k+1}, \dots, q_k + (n_0+1)q_{k+1}$ and $W_{\gamma,k}(t) = W_{\gamma,k,N}(t)$ is given by

$$\begin{cases} 0 & \text{if } n_0 < N, \\ (w_{C_k} - N(w_{\mathcal{B}_k} - w_{\mathcal{A}_0}))(q_k + (N+1)q_{k+1} - \xi Q) & \text{if } n_0 = N, \\ (w_{\mathcal{B}_k} - w_{\mathcal{A}_0})(q_k + (N+1)q_{k+1} - \xi Q) + (w_{C_k} - (N+1)(w_{\mathcal{B}_k} - w_{\mathcal{A}_0}))q_{k+1} & \text{if } n_0 > N, \end{cases}$$

$$= \begin{cases} 0 & \text{if } t \in (\lambda_{k,N}, t_{k-1}], \\ W_{\gamma,k,N}^{(3)}(t) := (q_k + (N+1)q_{k+1} - \xi Q) & \\ \quad \cdot (Na_{k+1} + a_{k-1} - 2\varepsilon - (Nq_{k+1} + q_{k-1})t) & \text{if } t \in (\lambda_{k,N+1}, \lambda_{k,N}], \\ W_{\gamma,k}^{(4)}(t) := w_{C_k}(t)q_{k+1} - (w_{\mathcal{B}_k}(t) - w_{\mathcal{A}_0}(t))(\xi Q - q_k) & \text{if } t \in (\gamma_{k+1}, \lambda_{k,N+1}]. \end{cases}$$

Since $\lambda_{k,0} = t_{k-1}$, the corresponding contribution is given by

$$\mathbb{G}_{I,Q}^{(4.2.2)}(\xi) = \sum_{0 \leq N \leq \xi} \sum_{k=1}^{\infty} \sum_{\substack{q_{k+1} \leq 2Q \\ q_{k+1} \in \mathcal{J}_{q,k+1} \cap \mathcal{J}_{q,N}}}^* \left(\int_{\lambda_{k,N+1}}^{\lambda_{k,N}} \frac{W_{\gamma,k,N}^{(3)}(t) dt}{t^2 + t + 1} + \int_{\gamma_{k+1}}^{\lambda_{k,N+1}} \frac{W_{\gamma,k}^{(4)}(t) dt}{t^2 + t + 1} \right).$$

Employing (13.12), (13.13), (13.14) we find

$$\mathbb{G}_{I,Q}^{(4.2.2)}(\xi) \cong \frac{c_I}{8\zeta(2)} \sum_{0 \leq N \leq \xi} \int_0^1 du \int_{[1+u,2] \cap [\frac{\xi+u}{N+2}, \frac{\xi+u}{N+1}]} dw F_N^{(4.2.2)}(\xi; u, w), \quad (9.9)$$

where

$$F_N^{(4.2.2)}(\xi; u, w) = \frac{(2-w)^2}{((N+2)w - 2u)^2} \left(\frac{(N+2)w - u - \xi}{(N+1)w - 2u} + \frac{(2N+4)w - 3u - \xi}{w} \right).$$

9.2. **The channel C_{\leftarrow} when $r = 1$ and $r_k = -1$.** The contributions of $(C_{\leftarrow}, r = 1, r_k = -1)$ and of $(C_{\downarrow}, r = -1, r_k = 1)$ have the same main and error terms, so we shall consider below the former situation and double the result. The slits $q + nq_{k+1}$ are removed, while $2q + nq_{k+1}$ are not, $n \geq 0$ (see Figure 17). Note that $B(2q) = 2(w_{\mathcal{B}_k} + w_{C_k}) > B(q_{k+1}) = w_{C_k} + 2w_{\mathcal{B}_k}$. Again, two cases arise:

9.2.1. $w_{\mathcal{A}_0} \leq w_{\mathcal{B}_k}$ ($\iff t \geq \gamma_{k+1}$). The slit q_{k+1} locks the channel \mathcal{A}_0 and $W_{\gamma,k}(t) = w_{\mathcal{A}_0}(t) \cdot (q_{k+1} - \xi Q)_+ \wedge q$. We must have $\gamma_{k+1} < t_{k-1}$, so $k \geq 1$ and $q_{k+1} \leq 2Q$. The corresponding contribution is

$$\mathbb{G}_{I,Q}^{(4.3.1)}(\xi) = \sum_{k=1}^{\infty} \sum_{\substack{q_{k+1} \in \mathcal{I}_{q,k+1} \\ q_{k+1} \leq 2Q}}^* (q_{k+1} - \xi Q)_+ \wedge q \int_{\gamma_{k+1}}^{t_{k-1}} \frac{w_{\mathcal{A}_0}(t) dt}{t^2 + t + 1}.$$

Employing (13.2) we find

$$\mathbb{G}_{I,Q}^{(4.3.1)}(\xi) \cong \frac{c_I}{8\zeta(2)} \int_0^1 du \int_{1+u}^2 dw \frac{2-w}{(w-2u)w} \left(\frac{w-1}{w} + \frac{w-u-1}{w-2u} \right) \cdot (w-\xi)_+ \wedge u. \quad (9.10)$$

9.2.2. $w_{\mathcal{A}_0} > w_{\mathcal{B}_k}$ ($\iff t < \gamma_{k+1}$). Consider first the sub-channel of \mathcal{A}_0 of width $w_{\mathcal{B}_k}$ locked by the slit q_{k+1} . Its contribution is

$$\begin{aligned} \mathbb{G}_{I,Q}^{(4.3.2)}(\xi) &= \sum_{k=0}^{\infty} \sum_{\substack{q_{k+1} \in \mathcal{I}_{q,k+1} \\ q_{k+1} \leq 2Q}}^* (q_{k+1} - \xi Q)_+ \wedge q \int_{t_k}^{\gamma_{k+1}} \frac{w_{\mathcal{B}_k}(t) dt}{t^2 + t + 1} \\ &\quad + \sum_{k=1}^{\infty} \sum_{\substack{q_{k+1} \in \mathcal{I}_{q,k+1} \\ q_{k+1} > 2Q}}^* (q_{k+1} - \xi Q)_+ \wedge q \int_{t_k}^{t_{k-1}} \frac{w_{\mathcal{B}_k}(t) dt}{t^2 + t + 1}. \end{aligned}$$

Employing (10.8) and (5.6) we find

$$\mathbb{G}_{I,Q}^{(4.3.2)}(\xi) \cong \frac{c_I}{8\zeta(2)} \int_0^1 du \left(\int_1^2 dw F^{(4.3.2.1)}(\xi; u, w) + \int_2^{\infty} dw F^{(4.3.2.2)}(\xi; u, w) \right), \quad (9.11)$$

where

$$F^{(4.3.2.1)}(\xi; u, w) = \frac{(w-1)^2}{(w-u)w^2} \cdot (w-\xi)_+ \wedge u,$$

$$F^{(4.3.2.2)}(\xi; u, w) = \frac{(1-u)^2}{(w-2u)^2(w-u)} \cdot (w-\xi)_+ \wedge u.$$

The remaining part $\tilde{\mathcal{A}}_0$ of \mathcal{A}_0 (of total width $w_{\mathcal{A}_0} - w_{\mathcal{B}_k}$) is locked by the slits $2q + n_0q_{k+1}$ and $2q + (n_0 + 1)q_{k+1}$, with n_0 uniquely determined by $2\varepsilon > 2(w_{\mathcal{B}_k} + w_{C_k}) - n_0(w_{\mathcal{A}_0} - w_{\mathcal{B}_k}) \geq 2w_{\mathcal{B}_k} + w_{C_k}$, or equivalently $n_0 = \left\lfloor \frac{w_{C_k}}{w_{\mathcal{A}_0} - w_{\mathcal{B}_k}} \right\rfloor = \left\lfloor \frac{a_{k-1} - 2\varepsilon - q_{k-1}t}{a_{k+1} - q_{k+1}t} \right\rfloor \geq 0$. The widths of the relevant sub-channels (from bottom to top) are $2\varepsilon - 2(w_{\mathcal{B}_k} + w_{C_k}) + n_0(w_{\mathcal{A}_0} - w_{\mathcal{B}_k}) = (n_0 + 1)a_{k+1} - a_{k-1} + 2\varepsilon - ((n_0 + 1)q_{k+1} - q_{k-1})t$ and $w_{C_k} - n_0(w_{\mathcal{A}_0} - w_{\mathcal{B}_k}) = (n_0q_{k+1} - q_{k-1})t - n_0a_{k+1} + a_{k-1} - 2\varepsilon$. The following two subcases arise:

(I) $n_0 = 0$ ($\iff t < \frac{a+\varepsilon}{q}$). From $t_k < \frac{a+\varepsilon}{q}$ we infer $q_{k+2} > 2Q$. In this situation we have

$$W_{\gamma,k,0}(t) = 2(a + \varepsilon - qt) \cdot (2q - \xi Q)_+ \wedge q + w_{C_k}(t) \cdot (2q + q_{k+1} - \xi Q)_+ \wedge q,$$

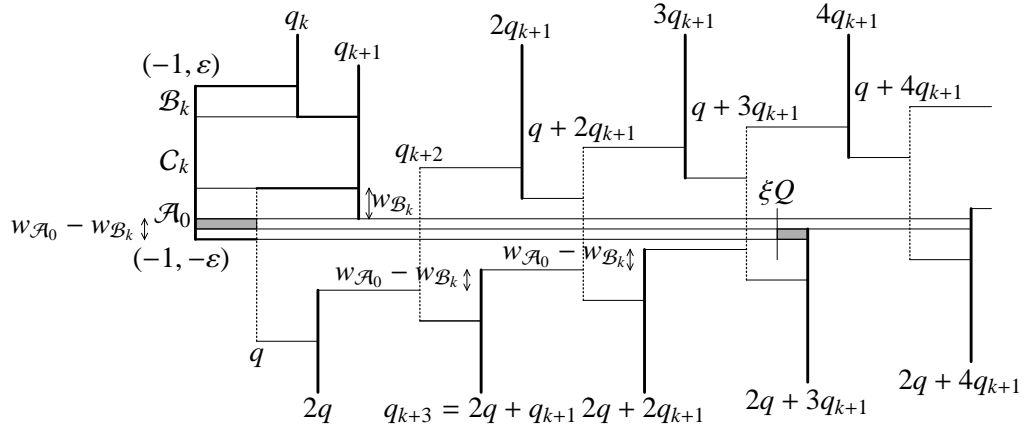

FIGURE 17. The case $t \in I_{\gamma,k}$, $r = 1$, $r_k = -1$, $r_{k+1} = 0$, C_{\leftarrow} , $w_{\mathcal{A}_0} > w_{\mathcal{B}_k}$, $n_0 = 3$

with contribution ($q_{k+1} > 2Q \iff t_{k-1} < \gamma_{k+1}$)

$$\mathbb{G}_{I,Q}^{(4.3.3)}(\xi) = \sum_{k=0}^{\infty} \sum_{\substack{q_{k+1} \in \mathcal{I}_{q,k+1} \\ 2Q - q < q_{k+1} \leq 2Q}}^* \int_{t_k}^{\frac{a+\varepsilon}{q}} \frac{W_{\gamma,k,0}(t) dt}{t^2 + t + 1} + \sum_{k=1}^{\infty} \sum_{\substack{q_{k+1} \in \mathcal{I}_{q,k+1} \\ q_{k+1} > 2Q}}^* \int_{t_k}^{t_{k-1}} \frac{W_{\gamma,k,0}(t) dt}{t^2 + t + 1}.$$

Employing (10.14), (10.15), (10.16), (5.7), (10.1) we find

$$\mathbb{G}_{I,Q}^{(4.3.3)}(\xi) \cong \frac{c_I}{8\zeta(2)} \int_0^1 du \left(\int_{2-u}^2 dw F^{(4.3.3.1)}(\xi; u, w) + \int_2^{\infty} dw F^{(4.3.3.2)}(\xi; u, w) \right), \quad (9.12)$$

where

$$\begin{aligned} F^{(4.3.3.1)}(\xi; u, w) &= \frac{w+u-2}{2u(w-u)} \left(\frac{1-u}{w-u} + \frac{2-w}{2u} \right) \cdot (w+2u-\xi)_+ \wedge u \\ &\quad + \frac{(w+u-2)^2}{2u(w-u)^2} \cdot (2u-\xi)_+ \wedge u, \\ F^{(4.3.3.2)}(\xi; u, w) &= \frac{(1-u)^2}{(w-2u)(w-u)^2} \cdot (w+2u-\xi)_+ \wedge u \\ &\quad + \frac{1-u}{(w-2u)(w-u)} \left(\frac{w-2}{w-2u} + \frac{w+u-2}{w-u} \right) \cdot (2u-\xi)_+ \wedge u. \end{aligned}$$

(II) $n_0 \geq 1$ ($\iff t \geq \frac{a+\varepsilon}{q}$). From $\frac{a+\varepsilon}{q} \leq \gamma_{k+1}$ we infer $q_{k+1} \leq 2Q$. Taking $\lambda_{k,n}$ as in (9.3) we obtain, when $t \in [\lambda_{k,n_0}, \lambda_{k,n_0+1})$,

$$\begin{aligned} W_{\gamma,k,n}(t) &= ((n_0+1)a_{k+1} - a_{k-1} + 2\varepsilon - ((n_0+1)q_{k+1} - q_{k-1})t) \cdot (2q + n_0q_{k+1} - \xi Q)_+ \wedge q \\ &\quad + ((n_0q_{k+1} - q_{k-1})t - n_0a_{k+1} + a_{k-1} - 2\varepsilon) \cdot (2q + (n_0+1)q_{k+1} - \xi Q)_+ \wedge q. \end{aligned}$$

Ordering $\lambda_{k,n_0}, \lambda_{k,n_0+1}$ and t_k , the corresponding contribution takes the form

$$\mathbb{G}_{I,Q}^{(4.3.4)}(\xi) = \sum_{n=1}^{\infty} \sum_{k=0}^{\infty} \left(\sum_{\substack{q_{k+1} \in \mathcal{I}_{q,k+1} \\ Q + \frac{Q-q}{n+1} < q_{k+1} \leq Q + \frac{Q-q}{n}}}^* \int_{t_k}^{\lambda_{k,n+1}} \frac{W_{\gamma,k,n}(t) dt}{t^2 + t + 1} + \sum_{\substack{q_{k+1} \in \mathcal{I}_{q,k+1} \\ Q + \frac{Q-q}{n} < q_{k+1} \leq 2Q}}^* \int_{\lambda_{k,n}}^{\lambda_{k,n+1}} \frac{W_{\gamma,k,n}(t) dt}{t^2 + t + 1} \right).$$

Employing (13.8)-(13.11) we find

$$\begin{aligned} \mathbb{G}_{I,Q}^{(4.3.4)}(\xi) &\cong \frac{c_I}{8\zeta(2)} \sum_{n=1}^{\infty} \int_0^1 du \int_{1+\frac{1-u}{n+1}}^{1+\frac{1-u}{n}} dw F_n^{(4.3.4.1)}(\xi; u, w) \\ &\quad + \frac{c_I}{8\zeta(2)} \sum_{n=1}^{\infty} \int_0^1 du \int_{1+\frac{1-u}{n}}^2 dw F_n^{(4.3.4.2)}(\xi; u, w), \end{aligned} \quad (9.13)$$

where

$$\begin{aligned} F_n^{(4.3.4.1)}(\xi; u, w) &= \frac{((n+1)(w-1) + u - 1)^2}{(w-u)^2(nw+2u)} \cdot (nw+2u-\xi)_+ \wedge u \\ &\quad + \frac{(n+1)(w-1) + u - 1}{(w-u)(nw+2u)} \left(\frac{2-w}{nw+2u} + \frac{1-u-n(w-1)}{w-u} \right) \cdot ((n+1)w+2u-\xi)_+ \wedge u, \\ F_n^{(4.3.4.2)}(\xi; u, w) &= \frac{(2-w)^2}{(nw+2u)((n-1)w+2u)^2} \cdot (nw+2u-\xi)_+ \wedge u \\ &\quad + \frac{(2-w)^2}{(nw+2u)^2((n-1)w+2u)} \cdot ((n+1)w+2u-\xi)_+ \wedge u. \end{aligned}$$

9.3. The channel C_{\leftarrow} when $r = -1$ and $r_k = 1$. The $(C_{\leftarrow}, r = -1, r_k = 1)$ and $(C_{\downarrow}, r = 1, r_k = -1)$ contributions have the same main and error terms, so we shall consider below the former situation and double the result. This is analogous to Section 9.2, only that this time the slits $q_k + nq_{k+1}$ are removed, while $2q + nq_{k+1}$ are not. Two cases arise:

9.3.1. $w_{\mathcal{B}_k} \leq w_{\mathcal{A}_0}$ ($\iff t \leq \gamma_{k+1}$). The slit q_{k+1} locks the channel \mathcal{B}_k and $W_{\gamma,k}(t) = w_{\mathcal{B}_k}(t) \cdot (q_{k+1} - \xi Q)_+ \wedge q_k$. The contribution

$$\begin{aligned} \mathbb{G}_{I,Q}^{(4.4.1)}(\xi) &= \sum_{k=0}^{\infty} \sum_{\substack{q_{k+1} \in \mathcal{I}_{q,k+1} \\ q_{k+1} \leq 2Q}}^* (q_{k+1} - \xi Q)_+ \wedge q_k \int_{t_k}^{\gamma_{k+1}} \frac{w_{\mathcal{B}_k}(t) dt}{t^2 + t + 1} \\ &\quad + \sum_{k=1}^{\infty} \sum_{\substack{q_{k+1} \in \mathcal{I}_{q,k+1} \\ q_{k+1} > 2Q}}^* (q_{k+1} - \xi Q)_+ \wedge q_k \int_{t_k}^{t_{k-1}} \frac{w_{\mathcal{B}_k}(t) dt}{t^2 + t + 1} \end{aligned}$$

is estimated upon (10.8), (5.3), (5.6) as

$$\mathbb{G}_{I,Q}^{(4.4.1)}(\xi) \cong \frac{c_I}{8\zeta(2)} \int_0^1 du \left(\int_1^2 dw F^{(4.4.1.1)}(\xi; u, w) + \int_2^{\infty} dw F^{(4.4.1.2)}(\xi; u, w) \right), \quad (9.14)$$

where

$$\begin{aligned} F^{(4.4.1.1)}(\xi; u, w) &= \frac{(w-1)^2}{(w-u)w^2} \cdot (w-\xi)_+ \wedge (w-u), \\ F^{(4.4.1.2)}(\xi; u, w) &= \frac{(1-u)^2}{(w-2u)^2(w-u)} \cdot (w-\xi)_+ \wedge (w-u). \end{aligned}$$

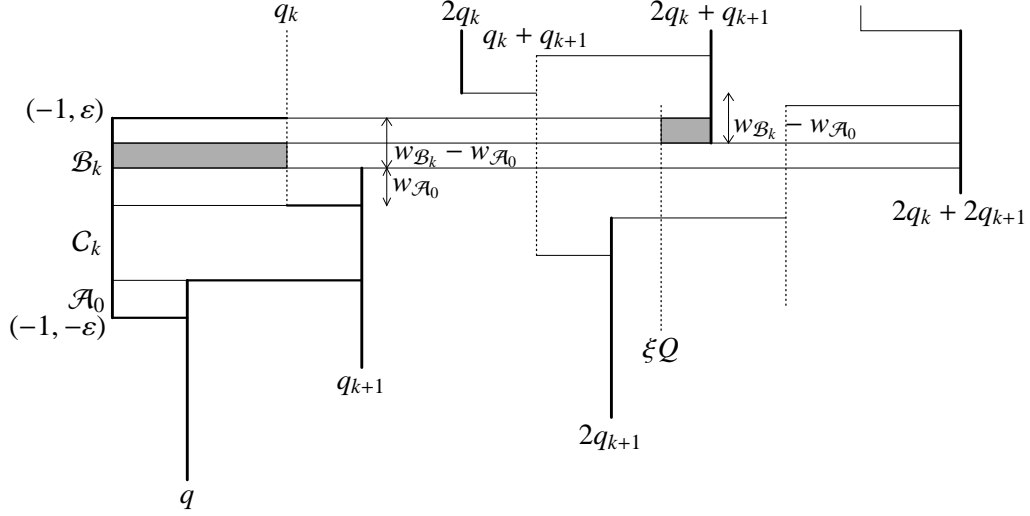

FIGURE 18. The case $t \in I_{\gamma,k}$, $r = -1$, $r_k = 1$, $r_{k+1} = 0$, C_{\leftarrow} , $w_{\mathcal{A}_0} < w_{\mathcal{B}_k}$, $n_0 = 1$

9.3.2. $w_{\mathcal{A}_0} < w_{\mathcal{B}_k}$ ($\iff t > \gamma_{k+1}$). Then $k \geq 1$ and $q_{k+1} \leq 2Q$. Consider first the sub-channel of \mathcal{B}_k of width $w_{\mathcal{A}_0}$ locked by q_{k+1} , with contribution

$$\mathbb{G}_{I,Q}^{(4.4.2)}(\xi) = \sum_{k=1}^{\infty} \sum_{\substack{q_{k+1} \in \mathcal{I}_{q,k+1} \\ q_{k+1} \leq 2Q}}^* (q_{k+1} - \xi Q)_+ \wedge q_k \int_{\gamma_{k+1}}^{t_{k-1}} \frac{w_{\mathcal{A}_0}(t) dt}{t^2 + t + 1}$$

estimated upon (11.1) as

$$\cong \frac{c_I}{8\zeta(2)} \int_0^1 du \int_{1+u}^2 dw \frac{2-w}{(w-2u)w} \left(\frac{w-1}{w} + \frac{w-u-1}{w-2u} \right) \cdot (w-\xi)_+ \wedge (w-u). \quad (9.15)$$

The remaining sub-channel $\tilde{\mathcal{B}}_k$ of \mathcal{B}_k (of width $w_{\mathcal{B}_k} - w_{\mathcal{A}_0}$) is locked by the slits $2q_k + n_0 q_{k+1}$ and $2q_k + (n_0 + 1)q_{k+1}$, with n_0 uniquely determined by $0 \leq B(2q_k) + n_0(w_{\mathcal{B}_k} - w_{\mathcal{A}_0}) < w_{\mathcal{B}_k} - w_{\mathcal{A}_0} = T(q_{k+1})$, or equivalently $n_0 := \lfloor \frac{w_{\mathcal{C}_k}}{w_{\mathcal{B}_k} - w_{\mathcal{A}_0}} \rfloor = \lfloor \frac{a_{k-1} - 2\varepsilon - q_{k-1}t}{q_{k+1}t - a_{k+1}} \rfloor \geq 0$. The situation is described in Figure 18. The widths of the relevant two sub-channels of $\tilde{\mathcal{B}}_k$ are (from top to bottom) $B(2q_k + n_0 q_{k+1}) = ((n_0 + 1)q_{k+1} + q_{k-1})t - (n_0 + 1)a_{k+1} - a_{k-1} + 2\varepsilon$ and $w_{\mathcal{B}_k} - w_{\mathcal{A}_0} - B(2q_k + n_0 q_{k+1}) = n_0 a_{k+1} + a_{k-1} - 2\varepsilon - (n_0 q_{k+1} + q_{k-1})t$. Taking this time $\lambda_{k,n}$ as in (9.8) we find, for $t \in (\lambda_{k,n_0+1}, \lambda_{k,n_0}]$,

$$W_{\gamma,k,n_0}(t) = \left(((n_0 + 1)q_{k+1} + q_{k-1})t - ((n_0 + 1)a_{k+1} + a_{k-1} - 2\varepsilon) \right) \cdot (2q_k + n_0 q_{k+1} - \xi Q)_+ \wedge q_k \\ + \left(n_0 a_{k+1} + a_{k-1} - 2\varepsilon - (n_0 q_{k+1} + q_{k-1})t \right) \cdot (2q_k + (n_0 + 1)q_{k+1} - \xi Q)_+ \wedge q_k.$$

Since $\lambda_{k,0} = t_{k-1}$ the corresponding contribution is given by

$$\mathbb{G}_{I,Q}^{(4.4.3)}(\xi) = \sum_{n=0}^{\infty} \sum_{k=1}^{\infty} \sum_{\substack{q_{k+1} \in \mathcal{I}_{q,k+1} \\ q_{k+1} \leq 2Q}}^* \int_{\lambda_{k,n+1}}^{\lambda_{k,n}} \frac{W_{\gamma,k,n}(t) dt}{t^2 + t + 1}.$$

Employing (13.14) and (13.15) we find

$$\mathbb{G}_{I,Q}^{(4,4,3)}(\xi) \approx \frac{c_I}{8\zeta(2)} \int_0^1 du \int_{1+u}^2 dw \sum_{n=0}^{\infty} F_n^{(4,4,3)}(\xi; u, w), \quad (9.16)$$

where

$$F_n^{(4,4,3)}(\xi; u, w) = \frac{(2-w)^2}{((n+1)w-2u)^2((n+2)w-2u)} \cdot ((n+2)w-2u-\xi)_+ \wedge (w-u) \\ + \frac{(2-w)^2}{((n+1)w-2u)((n+2)w-2u)^2} \cdot ((n+3)w-2u-\xi)_+ \wedge (w-u).$$

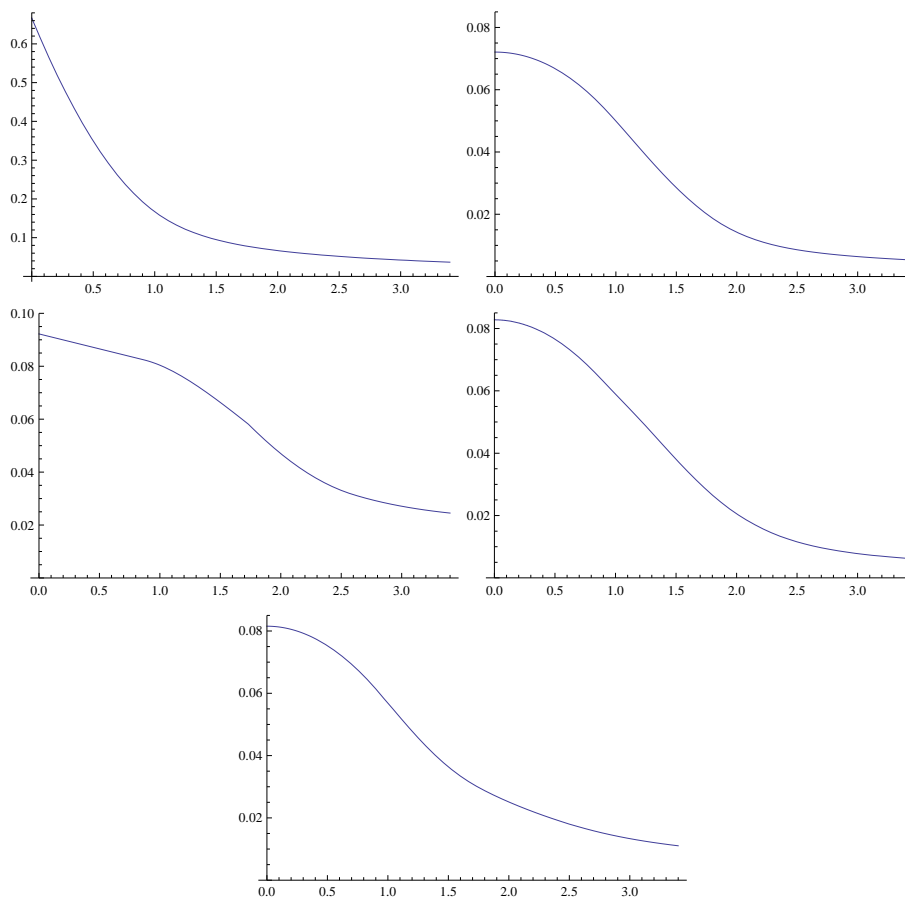

FIGURE 19. The individual contributions of $\mathbb{G}^{(0)}, \dots, \mathbb{G}^{(4)}$ to Φ^{hex}

10. APPENDIX 1

10.1. For $k \geq 1$:

$$\begin{aligned} \int_{t_k}^{t_{k-1}} \frac{2(a + \varepsilon - qt) dt}{t^2 + t + 1} &= -2 \left(\int_{\gamma}^{t_{k-1}} \frac{qt - a}{t^2 + t + 1} dt - \int_{\gamma}^{t_k} \frac{qt - a}{t^2 + t + 1} dt \right) \\ &\quad + \int_{t_k}^{t_{k-1}} \frac{2\varepsilon}{t^2 + t + 1} dt \\ &= \frac{Q - q}{2Q^2 q_{k-1} q_k (\gamma^2 + \gamma + 1)} \left(\frac{q_{k+1} - 2Q}{q_{k-1}} + \frac{q_{k+2} - 2Q}{q_k} \right) + o\left(\frac{1}{Qq^2 q_{k-1}^2}\right). \end{aligned} \quad (10.1)$$

10.2. For $k \geq 1$ and $q_{k+1} \leq 2Q$:

$$\int_{\frac{q_k - \varepsilon}{q_k}}^{t_{k-1}} \frac{w_{C_k}(t) dt}{t^2 + t + 1} = \frac{(2Q - q_{k+1})^2}{8Q^2 q_{k-1} q_k^2 (\gamma^2 + \gamma + 1)} + o\left(\frac{1}{Qq q_k^3}\right). \quad (10.2)$$

$$\int_{\frac{q_k - \varepsilon}{q_k}}^{t_{k-1}} \frac{2(q_k t - a_k + \varepsilon) dt}{t^2 + t + 1} = \frac{(2Q - q_{k+1})^2}{4Q^2 q_{k-1}^2 q_k (\gamma^2 + \gamma + 1)} + o\left(\frac{1}{Q^2 q q_k^2}\right). \quad (10.3)$$

$$\begin{aligned} \int_{\frac{q_k - \varepsilon}{q_k}}^{t_{k-1}} \frac{w_{\mathcal{A}_0}(t) dt}{t^2 + t + 1} &= \int_{\frac{q_k - \varepsilon}{q_k}}^{u_0} \frac{a + 2\varepsilon - qt}{t^2 + t + 1} dt - \int_{t_{k-1}}^{u_0} \frac{a + 2\varepsilon - qt}{t^2 + t + 1} dt \\ &= \frac{2Q - q_{k+1}}{4Q^2 q_{k-1} q_k (\gamma^2 + \gamma + 1)} \left(\frac{q_k + q_{k+1} - 2Q}{2q_k} + \frac{q_k - Q}{q_{k-1}} \right) + o\left(\frac{1}{q^2 q_{k-1} q_k^2}\right). \end{aligned} \quad (10.4)$$

$$\begin{aligned} \int_{\gamma_{k+1}}^{\frac{q_k - \varepsilon}{q_k}} \frac{w_{\mathcal{A}_0}(t) dt}{t^2 + t + 1} &= \int_{\gamma_{k+1}}^{u_0} \frac{a + 2\varepsilon - qt}{t^2 + t + 1} dt - \int_{\frac{q_k - \varepsilon}{q_k}}^{u_0} \frac{a + 2\varepsilon - qt}{t^2 + t + 1} dt \\ &= \frac{2Q - q_{k+1}}{4Q^2 q_k q_{k+1} (\gamma^2 + \gamma + 1)} \left(\frac{q_{k+1} - Q}{q_{k+1}} + \frac{q_k + q_{k+1} - 2Q}{2q_k} \right) + o\left(\frac{1}{q^2 q_k q_{k+1}^2}\right). \end{aligned} \quad (10.5)$$

$$\int_{\gamma_{k+1}}^{\frac{q_k - \varepsilon}{q_k}} \frac{q_{k+1} t - a_{k+1}}{t^2 + t + 1} dt = \frac{(2Q - q_{k+1})^2}{8Q^2 q_k^2 q_{k+1} (\gamma^2 + \gamma + 1)} + o\left(\frac{1}{q q_k^2 q_{k+1}^2}\right). \quad (10.6)$$

$$\int_{\gamma_{k+1}}^{\frac{q_k - \varepsilon}{q_k}} \frac{2(a_k - \varepsilon - q_k t)}{t^2 + t + 1} dt = \frac{(2Q - q_{k+1})^2}{4Q^2 q_k q_{k+1}^2 (\gamma^2 + \gamma + 1)} + o\left(\frac{1}{q q_k^2 q_{k+1}^2}\right). \quad (10.7)$$

$$\int_{t_k}^{\gamma_{k+1}} \frac{w_{\mathcal{B}_k}(t) dt}{t^2 + t + 1} = \frac{(q_{k+1} - Q)^2}{2Q^2 q_k q_{k+1}^2 (\gamma^2 + \gamma + 1)} + o\left(\frac{1}{q q_k^2 q_{k+1}^2}\right). \quad (10.8)$$

$$\begin{aligned} \int_{t_k}^{\gamma_{k+1}} \frac{w_{\mathcal{A}_0}(t) - w_{\mathcal{B}_k}(t)}{t^2 + t + 1} dt &= \int_{t_k}^{\gamma_{k+1}} \frac{a_{k+1} - q_{k+1} t}{t^2 + t + 1} dt \\ &= \frac{(q_{k+1} - Q)^2}{2Q^2 q_k^2 q_{k+1} (\gamma^2 + \gamma + 1)} + o\left(\frac{1}{q q_k^2 q_{k+1}^2}\right). \end{aligned} \quad (10.9)$$

10.3. For $k \geq 0$ and $q_{k+1} \leq 2Q - q$:

$$\begin{aligned} \int_{t_k}^{\gamma_{k+1}} \frac{2(qt - a - \varepsilon)}{t^2 + t + 1} dt &= \int_{\frac{a+\varepsilon}{q}}^{\gamma_{k+1}} \frac{2(qt - a - \varepsilon)}{t^2 + t + 1} dt - \int_{\frac{a+\varepsilon}{q}}^{t_k} \frac{2(qt - a - \varepsilon)}{t^2 + t + 1} dt \\ &= \frac{q_{k+1} - Q}{2Q^2 q_k q_{k+1} (\gamma^2 + \gamma + 1)} \left(\frac{2Q - q_{k+1}}{q_{k+1}} + \frac{2Q - q_{k+2}}{q_k} \right) + O\left(\frac{1}{q^3 q_{k+1}^2}\right). \end{aligned} \quad (10.10)$$

10.4. For $k \geq 0$ and $2Q - q < q_{k+1} \leq 2Q$ it follows that $0 \leq q_{k+2} - 2Q \leq q$, $k = \lfloor \frac{2Q - q - q'}{q} \rfloor$, and

$$\begin{aligned} \int_{t_k}^{\frac{a+\varepsilon}{q}} \frac{w_{\mathcal{A}_0}(t) dt}{t^2 + t + 1} &= \int_{t_k}^{u_0} \frac{a + 2\varepsilon - qt}{t^2 + t + 1} dt - \int_{\frac{a+\varepsilon}{q}}^{u_0} \frac{a + 2\varepsilon - qt}{t^2 + t + 1} dt \\ &= \frac{(q_{k+2} - 2Q)(q_k + 2q_{k+1} - 2Q)}{8Q^2 q q_k^2 (\gamma^2 + \gamma + 1)} + O\left(\frac{1}{q^2 q' q_k^2}\right). \end{aligned} \quad (10.11)$$

$$\begin{aligned} \int_{t_k}^{\frac{a+\varepsilon}{q}} \frac{qt - a}{t^2 + t + 1} dt &= \int_{\gamma}^{\frac{a+\varepsilon}{q}} \frac{qt - a}{t^2 + t + 1} dt - \int_{\gamma}^{t_k} \frac{qt - a}{t^2 + t + 1} dt \\ &= \frac{(q_{k+2} - 2Q)(q_{k-2} + 2Q)}{8Q^2 q q_k^2 (\gamma^2 + \gamma + 1)} + O\left(\frac{1}{Q^3 q^2}\right). \end{aligned} \quad (10.12)$$

$$\int_{t_k}^{\frac{a+\varepsilon}{q}} \frac{w_{\mathcal{B}_k}(t) dt}{t^2 + t + 1} = \frac{(q_{k+2} - 2Q)^2}{8Q^2 q^2 q_k (\gamma^2 + \gamma + 1)} + O\left(\frac{1}{Q^2 q q_k^2}\right). \quad (10.13)$$

$$\int_{t_k}^{\frac{a+\varepsilon}{q}} \frac{2(a + \varepsilon - qt) dt}{t^2 + t + 1} = \frac{(q_{k+2} - 2Q)^2}{4Q^2 q q_k^2 (\gamma^2 + \gamma + 1)} + O\left(\frac{1}{Q q q' q_k^2}\right). \quad (10.14)$$

$$\begin{aligned} \int_{t_k}^{\frac{a+\varepsilon}{q}} \frac{w_{\mathcal{C}_k}(t) dt}{t^2 + t + 1} &= \int_{t_k}^{t_{k-1}} \frac{a_{k-1} - 2\varepsilon - q_{k-1}t}{t^2 + t + 1} dt - \int_{\frac{a+\varepsilon}{q}}^{t_{k-1}} \frac{a_{k-1} - 2\varepsilon - q_{k-1}t}{t^2 + t + 1} dt \\ &= \frac{q_{k+2} - 2Q}{4Q^2 q q_k (\gamma^2 + \gamma + 1)} \left(\frac{Q - q}{q_k} + \frac{2Q - q_{k+1}}{2q} \right) + O\left(\frac{1}{Q q q_k^3}\right) \quad \text{if } k \geq 1. \end{aligned} \quad (10.15)$$

$$\begin{aligned} \int_{t_0}^{\frac{a+\varepsilon}{q}} \frac{w_{\mathcal{C}_0}(t) dt}{t^2 + t + 1} &= \int_{t_0}^{\gamma'} \frac{a' - q't}{t^2 + t + 1} dt - \int_{\frac{a+\varepsilon}{q}}^{\gamma'} \frac{a' - q't}{t^2 + t + 1} dt \\ &\quad - \left(\int_{t_0}^{u_0} \frac{a + 2\varepsilon - qt}{t^2 + t + 1} dt - \int_{\frac{a+\varepsilon}{q}}^{u_0} \frac{a + 2\varepsilon - qt}{t^2 + t + 1} dt \right) \\ &= \frac{q_2 - 2Q}{4Q^2 q q' (\gamma^2 + \gamma + 1)} \left(\frac{Q - q}{q'} + \frac{2Q - q_1}{2q} \right) + O\left(\frac{1}{Q^2 q q'^2}\right). \end{aligned} \quad (10.16)$$

$$\begin{aligned} \int_{\frac{a+\varepsilon}{q}}^{\gamma_{k+1}} \frac{w_{\mathcal{B}_k}(t) dt}{t^2 + t + 1} &= \int_{t_k}^{\gamma_{k+1}} \frac{q_k t - a_k + 2\varepsilon}{t^2 + t + 1} dt - \int_{t_k}^{\frac{a+\varepsilon}{q}} \frac{q_k t - a_k + 2\varepsilon}{t^2 + t + 1} dt \\ &= \frac{2Q - q_{k+1}}{4Q^2 q q_{k+1} (\gamma^2 + \gamma + 1)} \left(\frac{q_{k+1} - Q}{q_{k+1}} + \frac{q_{k+2} - 2Q}{2q} \right) + O\left(\frac{1}{Q^2 q q_k q_{k+1}}\right). \end{aligned} \quad (10.17)$$

$$\int_{\frac{a+\varepsilon}{q}}^{\gamma_{k+1}} \frac{a_{k+1} - q_{k+1}t}{t^2 + t + 1} dt = \frac{(2Q - q_{k+1})^2}{8Q^2 q^2 q_{k+1} (\gamma^2 + \gamma + 1)} + O\left(\frac{1}{q^3 q_{k+1}^2}\right). \quad (10.18)$$

$$\int_{\frac{a+\varepsilon}{q}}^{\gamma_{k+1}} \frac{2(qt - a - \varepsilon) dt}{t^2 + t + 1} = \frac{(2Q - q_{k+1})^2}{4Q^2 q q_{k+1}^2 (\gamma^2 + \gamma + 1)} + O\left(\frac{1}{Qq^2 q_{k+1}^2}\right). \quad (10.19)$$

$$\int_{\frac{a+\varepsilon}{q}}^{\gamma_{k+1}} \frac{w_{C_k}(t) dt}{t^2 + t + 1} = \frac{(2Q - q_{k+1})^2 q_{k+3}}{8Q^2 q^2 q_{k+1}^2 (\gamma^2 + \gamma + 1)} + \begin{cases} O\left(\frac{1}{q^3 q_{k-1}^2}\right) & \text{if } k \geq 1, \\ O\left(\frac{1}{q^3 q^2}\right) & \text{if } k = 0. \end{cases} \quad (10.20)$$

11. APPENDIX 2

11.1. Estimates for the C_O contribution when $(r, r_k) = (0, 1)$. Here $W_{\gamma,k,n}^{(1)}$ and $W_{\gamma,k}^{(2)}$ are as in (7.3) and (7.4).

11.1.1. For $k \geq 1$ and $q_{k+1} \leq 2Q$:

$$\begin{aligned} \int_{\gamma_{k+1}}^{t_{k-1}} \frac{w_{\mathcal{A}_0}(t) dt}{t^2 + t + 1} &= \int_{\gamma_{k+1}}^{u_0} \frac{a + 2\varepsilon - qt}{t^2 + t + 1} dt - \int_{t_{k-1}}^{u_0} \frac{a + 2\varepsilon - qt}{t^2 + t + 1} dt \\ &= \frac{2Q - q_{k+1}}{2Q^2 q_{k-1} q_{k+1} (\gamma^2 + \gamma + 1)} \left(\frac{q_{k+1} - Q}{q_{k+1}} + \frac{q_k - Q}{q_{k-1}} \right) + O\left(\frac{1}{Qq^2 q_{k+1}^2}\right). \end{aligned} \quad (11.1)$$

Summing as in (5.2) and employing Lemma 4 we infer

$$\begin{aligned} \mathbb{G}_{I,Q}^{(2.1)}(\xi) &= \sum_{\beta \in \{-1,1\}} \sum_{\substack{1 \leq q \leq Q \\ q \equiv -\beta \pmod{3}}} \sum_{k=1}^{\infty} \sum_{\substack{x=3\bar{x} \in q(1-I), (\bar{x}, q)=1 \\ y=q_k \in I_{q,k}, y \leq 2Q-q \\ \bar{x}y \equiv \frac{\beta q + 1}{3} \pmod{q}}} (y + q - \xi Q)_+ \wedge q \int_{\gamma_{k+1}}^{t_{k-1}} \frac{w_{\mathcal{A}_0}(t) dt}{t^2 + t + 1} \\ &\approx \frac{c_I C(3)}{3} \sum_{\beta \in \{-1,1\}} \frac{\varphi(q)}{q} \int_Q^{2Q-q} \frac{2Q - q - y}{2Q^2 (y - q)(y + q)} \left(\frac{y + q - Q}{y + q} + \frac{y - Q}{y - q} \right) \cdot (y + q - \xi Q)_+ \wedge q dy. \end{aligned}$$

Estimate (7.1) follows applying Lemma 2 and making the change of variable $(q, y) = (Qu, Qw)$.

11.1.2. For $k \geq 1$ and $q_{k+1} > 2Q$:

$$\begin{aligned} \int_{t_k}^{t_{k-1}} \frac{w_{\mathcal{A}_0}(t) - w_{\mathcal{B}_k}(t)}{t^2 + t + 1} dt &= \int_{t_k}^{\gamma_{k+1}} \frac{a_{k+1} - q_{k+1}t}{t^2 + t + 1} dt - \int_{t_{k-1}}^{\gamma_{k+1}} \frac{a_{k+1} - q_{k+1}t}{t^2 + t + 1} dt \\ &= \frac{Q - q}{2Q^2 q_{k-1} q_k (\gamma^2 + \gamma + 1)} \left(\frac{q_{k+1} - Q}{q_k} + \frac{q_{k+1} - 2Q}{q_{k-1}} \right) + O\left(\frac{1}{Q^2 q q_k q_{k+1}}\right). \end{aligned} \quad (11.2)$$

11.1.3. When $n \geq 1$ and $n(Q - q) \leq q_k \leq (n + 1)(Q - q)$:

$$\begin{aligned} \int_{t_k}^{\gamma_{k+n}} \frac{W_{\gamma,k,n}^{(1)}(t) dt}{t^2 + t + 1} &= (q_{k+n+1} - \xi Q) \int_{t_k}^{\gamma_{k+n}} \frac{a_{k+n} - q_{k+n}t}{t^2 + t + 1} dt \\ &= \frac{(q_{k+n} - nQ)^2 (q_{k+n+1} - \xi Q)}{2Q^2 q_k^2 q_{k+n} (\gamma^2 + \gamma + 1)} + O_{\xi} \left(\frac{1}{q q_k^2 q_{k+n}} \right). \end{aligned} \quad (11.3)$$

Here and below \ll_{ξ} means uniformly for ξ in compact subsets of $[0, \infty)$.

11.1.4. When $n \geq 1$ and $(n+1)(Q-q) \leq q_k \leq Q+n(Q-q)$:

$$\begin{aligned} \int_{\gamma_{k+n+1}}^{\gamma_{k+n}} \frac{W_{\gamma,k,n}^{(1)}(t) dt}{t^2+t+1} &= (q_{k+n+1} - \xi Q) \int_{\gamma_{k+n+1}}^{\gamma_{k+n}} \frac{a_{k+n} - q_{k+n}t}{t^2+t+1} dt \\ &= \frac{q_{k+n+1} - \xi Q}{2q_{k+n}q_{k+n+1}(\gamma^2 + \gamma + 1)} + O_\xi \left(\frac{1}{qq_{k+n}q_{k+n+1}^2} \right). \end{aligned} \quad (11.4)$$

11.1.5. When $k \geq 1$ and $Q+n(Q-q) \leq q_k \leq Q+(n+1)(Q-q)$:

$$\begin{aligned} \int_{\gamma_{k+n+1}}^{t_{k-1}} \frac{W_{\gamma,k,n}^{(1)}(t) dt}{t^2+t+1} &= (q_{k+n+1} - \xi Q) \left(\int_{\gamma_{k+n+1}}^{\gamma_{k+n}} \frac{a_{k+n} - q_{k+n}t}{t^2+t+1} dt - \int_{t_{k-1}}^{\gamma_{k+n}} \frac{a_{k+n} - q_{k+n}t}{t^2+t+1} dt \right) \\ &= \frac{((n+2)Q - q_{k+n+1})(q_{k+n+1} - \xi Q)}{2Q^2q_{k-1}q_{k+n+1}(\gamma^2 + \gamma + 1)} \left(\frac{Q}{q_{k+n+1}} + \frac{q_{k+n} - (n+1)Q}{q_{k-1}} \right) + O_\xi \left(\frac{1}{qq_{k-1}q_{k+n}q_{k+n+1}} \right). \end{aligned} \quad (11.5)$$

11.1.6. When $n \geq 1$ and $(n+1)(Q-q) \leq q_k \leq Q+(n+1)(Q-q)$:

$$\begin{aligned} \int_{t_k}^{\gamma_{k+n+1}} \frac{dt}{t^2+t+1} &= \frac{q_k - (n+1)(Q-q)}{Qq_kq_{k+n+1}(\gamma^2 + \gamma + 1)} + O \left(\frac{1}{Qqk_{k+n+1}^2} \right), \\ \int_{t_k}^{\gamma_{n+k+1}} \frac{w_{\mathcal{B}_k}(t) + w_{\mathcal{C}_k}(t)}{t^2+t+1} dt &= \int_{\gamma}^{\gamma_{k+n+1}} \frac{qt-a}{t^2+t+1} dt - \int_{\gamma}^{t_k} \frac{qt-a}{t^2+t+1} dt \\ &= \frac{q_k - (n+1)(Q-q)}{2Q^2q_kq_{k+n+1}(\gamma^2 + \gamma + 1)} \left(\frac{Q}{q_{n+k+1}} + \frac{Q-q}{q_k} \right) + O \left(\frac{1}{Q^2q_{n+k+1}^3} \right), \end{aligned}$$

yielding

$$\int_{t_k}^{\gamma_{k+n+1}} \frac{W_{\gamma,k}^{(2)}(t) dt}{t^2+t+1} = \frac{q_{k+n+1} - (n+1)Q}{2Qq_kq_{k+n+1}(\gamma^2 + \gamma + 1)} \left(\frac{q_{k+n+1} - \xi Q}{q_{k+n+1}} + \frac{q_k - \xi(Q-q)}{q_k} \right) + O_\xi \left(\frac{1}{Qqk_{k+n+1}^2} \right). \quad (11.6)$$

11.1.7. When $q_k \geq Q+(n+1)(Q-q)$ formulas (5.8) and (5.9) yield (here $k \geq 1$)

$$\int_{t_k}^{t_{k-1}} \frac{W_{\gamma,k}^{(2)}(t) dt}{t^2+t+1} = \frac{Q-q}{2Qq_{k-1}q_k(\gamma^2 + \gamma + 1)} \left(2 - \xi \left(\frac{Q-q}{q_{k-1}} + \frac{Q-q}{q_k} \right) \right) + O_\xi \left(\frac{1}{qq_{k-1}^2q_k} \right). \quad (11.7)$$

11.2. Estimates for the C_{\leftarrow} contribution when $(r, r_k) = (0, 1)$. Here $\lambda_{k,n}$ is as in (7.7).

11.2.1. $(n-1)(Q-q) \leq q_k \leq n(Q-q)$. In this case $n \geq 2$. When $k \geq 1$ we have

$$\begin{aligned} \int_{t_k}^{\lambda_{k,n}} \frac{w_{\mathcal{C}_k}(t) dt}{t^2+t+1} &= \int_{t_k}^{t_{k-1}} \frac{a_{k-1} - 2\varepsilon - q_{k-1}t}{t^2+t+1} dt - \int_{\lambda_{k,n}}^{t_{k-1}} \frac{a_{k-1} - 2\varepsilon - q_{k-1}t}{t^2+t+1} dt \\ &= \frac{q_k - (n-1)(Q-q)}{2Q^2q_k(q_k + q_{k+n-1})(\gamma^2 + \gamma + 1)} \left(\frac{Q-q}{q_k} + \frac{(n+1)Q - q_{k+n}}{q_k + q_{k+n-1}} \right) + O \left(\frac{1}{qq_{k-1}^2q_k^2} \right). \end{aligned} \quad (11.8)$$

$$\begin{aligned} \int_{t_k}^{\lambda_{k,n}} \frac{w_{\mathcal{B}_k}(t) dt}{t^2+t+1} &= \int_{t_k}^{\lambda_{k,n}} \frac{q_k t - a_k + 2\varepsilon}{t^2+t+1} dt \\ &= \frac{(q_k - (n-1)(Q-q))^2}{2Q^2q_k(q_k + q_{k+n-1})^2(\gamma^2 + \gamma + 1)} + O \left(\frac{1}{qq_k^2q_{k+n}^2} \right). \end{aligned} \quad (11.9)$$

$$\begin{aligned}
\int_{t_k}^{\lambda_{k,n}} \frac{q_{k+n}t - a_{k+n}}{t^2 + t + 1} dt &= \int_{\gamma_{k+n}}^{\lambda_{k,n}} \frac{q_{k+n}t - a_{k+n}}{t^2 + t + 1} dt - \int_{\gamma_{k+n}}^{t_k} \frac{q_{k+n}t - a_{k+n}}{t^2 + t + 1} dt \\
&= \frac{q_k - (n-1)(Q-q)}{2Q^2 q_k (q_k + q_{k+n-1})(\gamma^2 + \gamma + 1)} \left(\frac{(n+1)Q - q_{k+n}}{q_k + q_{k+n-1}} + \frac{n(Q-q) - q_k}{q_k} \right) + O\left(\frac{1}{qq_k^3 q_{k+n}}\right).
\end{aligned} \tag{11.10}$$

When $k = 0$ formulas (11.9) and (11.10) still hold. The main term in (11.8) remains the same but we need a more careful estimate to control the error term, getting

$$\begin{aligned}
\int_{t_0}^{\lambda_{0,n}} \frac{w_{C_0}(t) dt}{t^2 + t + 1} &= \int_{\gamma}^{\lambda_{0,n}} \frac{qt - a}{t^2 + t + 1} dt - \int_{\gamma}^{t_0} \frac{qt - a}{t^2 + t + 1} dt - \int_{t_0}^{\lambda_{0,n}} \frac{q't - a' + 2\varepsilon}{t^2 + t + 1} dt \\
&= \frac{q_{n-1} - (n-1)Q}{2Q^2 q'(q' + q_{n-1})(\gamma^2 + \gamma + 1)} \left(\frac{(n+1)Q - q_n}{q' + q_{n-1}} + \frac{Q - q}{q'} \right) + O\left(\frac{1}{Qq^2 q_{n-1}^2}\right).
\end{aligned} \tag{11.11}$$

Since n only takes one value $n = \lfloor \frac{Q+q_{k-1}}{Q-q} \rfloor$ for fixed k , the error terms in (11.8)-(11.11) do not play a role in the final asymptotic formula.

11.2.2. When $k \geq 1$ and $n(Q-q) \leq q_k \leq Q + n(Q-q)$:

$$\begin{aligned}
\int_{\lambda_{k,n+1}}^{\lambda_{k,n}} \frac{w_{C_k}(t) dt}{t^2 + t + 1} &= \int_{\lambda_{k,n+1}}^{t_{k-1}} \frac{a_{k-1} - 2\varepsilon - q_{k-1}t}{t^2 + t + 1} dt - \int_{\lambda_{k,n}}^{t_{k-1}} \frac{a_{k-1} - 2\varepsilon - q_{k-1}t}{t^2 + t + 1} dt \\
&= \frac{2Q - q}{2Q^2 (q_k + q_{k+n-1})(q_k + q_{k+n})(\gamma^2 + \gamma + 1)} \left(\frac{(n+2)Q - q_{k+n+1}}{q_k + q_{k+n}} + \frac{(n+1)Q - q_{k+n}}{q_k + q_{k+n-1}} \right) \\
&\quad + O\left(\frac{1}{(n-1)^3 q^2 q_k^3}\right).
\end{aligned} \tag{11.12}$$

$$\begin{aligned}
\int_{\lambda_{k,n+1}}^{\lambda_{k,n}} \frac{w_{B_k}(t) dt}{t^2 + t + 1} &= \int_{t_k}^{\lambda_{k,n}} \frac{q_k t - a_k + 2\varepsilon}{t^2 + t + 1} dt - \int_{t_k}^{\lambda_{k,n+1}} \frac{q_k t - a_k + 2\varepsilon}{t^2 + t + 1} dt \\
&= \frac{2Q - q}{2Q^2 (q_k + q_{k+n-1})(q_k + q_{k+n})(\gamma^2 + \gamma + 1)} \left(\frac{q_{k+n-1} - (n-1)Q}{q_k + q_{k+n-1}} + \frac{q_{k+n} - nQ}{q_k + q_{k+n}} \right) \\
&\quad + O\left(\frac{1}{qq_k q_{k+n}^3}\right).
\end{aligned} \tag{11.13}$$

$$\int_{\lambda_{k,n+1}}^{\gamma_{k+n}} \frac{a_{k+n} - q_{k+n}t}{t^2 + t + 1} dt = \frac{(q_{k+n} - nQ)^2}{2Q^2 q_{k+n} (q_k + q_{k+n})^2 (\gamma^2 + \gamma + 1)} + O\left(\frac{1}{qq_{k+n}^4}\right). \tag{11.14}$$

$$\int_{\gamma_{k+n}}^{\lambda_{k,n}} \frac{q_{k+n}t - a_{k+n}}{t^2 + t + 1} dt = \frac{((n+1)Q - q_{k+n})^2}{2Q^2 q_{k+n} (q_{k-1} + q_{k+n})^2 (\gamma^2 + \gamma + 1)} + O\left(\frac{1}{qq_{k+n}^4}\right). \tag{11.15}$$

11.2.3. When $k = 0$ and $n \geq 2$ we have $t_0 < \lambda_{0,n+1} < \gamma_n < \lambda_{0,n} \leq t_{k-1}$. Analog formulas as (11.12)-(11.15) hold, with same main terms and

$$\begin{aligned} \int_{\lambda_{0,n+1}}^{\lambda_{0,n}} \frac{w_{C_0}(t) dt}{t^2 + t + 1} &= \int_{\gamma}^{\lambda_{0,n}} \frac{qt - a}{t^2 + t + 1} dt - \int_{\gamma}^{\lambda_{0,n+1}} \frac{qt - a}{t^2 + t + 1} dt \\ &\quad - \left(\int_{t_0}^{\lambda_{0,n}} \frac{q't - a' + 2\varepsilon}{t^2 + t + 1} dt - \int_{t_0}^{\lambda_{0,n+1}} \frac{q't - a' + 2\varepsilon}{t^2 + t + 1} dt \right) \\ &= \frac{2Q - q}{2Q^2(q' + q_{n-1})(q' + q_n)(\gamma^2 + \gamma + 1)} \left(\frac{(n+2)Q - q_{n+1}}{q' + q_n} + \frac{(n+1)Q - q_n}{q' + q_{n-1}} \right) + O\left(\frac{1}{qq'q_n^3}\right). \end{aligned} \quad (11.16)$$

11.2.4. When $k = 0$ and $n = 1$ we have $t_0 \leq \lambda_{0,2} < \gamma_1 \leq \lambda_{0,1}$. We have

$$\begin{aligned} \int_{\lambda_{0,2}}^{\gamma_1} \frac{w_{B_0}(t) dt}{t^2 + t + 1} &= \int_{t_0}^{\gamma_1} \frac{q't - a' + 2\varepsilon}{t^2 + t + 1} dt - \int_{t_0}^{\lambda_{0,2}} \frac{q't - a' + 2\varepsilon}{t^2 + t + 1} dt \\ &= \frac{(q_1 - Q)^2(q' + 2q_1)}{2Q^2q_1^2(q' + q_1)^2(\gamma^2 + \gamma + 1)} + O\left(\frac{1}{Q^3qq'}\right). \end{aligned} \quad (11.17)$$

$$\int_{\lambda_{0,2}}^{\gamma_1} \frac{a_1 - q_1 t}{t^2 + t + 1} dt = \frac{(q_1 - Q)^2}{2Q^2q_1(q' + q_1)^2(\gamma^2 + \gamma + 1)} + O\left(\frac{1}{Q^4q}\right). \quad (11.18)$$

$$\begin{aligned} \int_{\lambda_{0,2}}^{\gamma_1} \frac{w_{C_0}(t) dt}{t^2 + t + 1} &= \int_{\lambda_{0,2}}^{\gamma'} \frac{a' - q't}{t^2 + t + 1} dt - \int_{\gamma_1}^{\gamma'} \frac{a' - q't}{t^2 + t + 1} dt - \int_{\lambda_{0,2}}^{\frac{a+2\varepsilon}{q}} \frac{a + 2\varepsilon - qt}{t^2 + t + 1} dt \\ &\quad + \int_{\gamma_1}^{\frac{a+2\varepsilon}{q}} \frac{a + 2\varepsilon - qt}{t^2 + t + 1} dt \\ &= \frac{q_1 - Q}{2Q^2q_1(q' + q_1)(\gamma^2 + \gamma + 1)} \left(\frac{3Q - q_2}{q' + q_1} + \frac{2Q - q_1}{q_1} \right) + O\left(\frac{1}{Q^3qq'}\right). \end{aligned} \quad (11.19)$$

11.2.5. When $Q + n(Q - q) \leq q_k \leq Q + (n+1)(Q - q)$:

$$\int_{\lambda_{k,n+1}}^{t_{k-1}} \frac{w_{C_k}(t) dt}{t^2 + t + 1} = \frac{((n+2)Q - q_{k+n+1})^2}{2Q^2q_{k-1}(q_k + q_{k+n})^2(\gamma^2 + \gamma + 1)} + O\left(\frac{1}{Qqq_{k-1}q_{k+n}^2}\right). \quad (11.20)$$

$$\begin{aligned} \int_{\lambda_{k,n+1}}^{t_{k-1}} \frac{w_{B_k}(t) dt}{t^2 + t + 1} &= \int_{t_k}^{t_{k-1}} \frac{q_k t - a_k + 2\varepsilon}{t^2 + t + 1} dt - \int_{t_k}^{\lambda_{k,n+1}} \frac{q_k t - a_k + 2\varepsilon}{t^2 + t + 1} dt \\ &= \frac{(n+2)Q - q_{k+n+1}}{2Q^2q_{k-1}(q_k + q_{k+n})(\gamma^2 + \gamma + 1)} \left(\frac{Q - q}{q_{k-1}} + \frac{q_{k+n} - nQ}{q_k + q_{k+n}} \right) + O\left(\frac{1}{Q^2qq_k^2}\right). \end{aligned} \quad (11.21)$$

$$\begin{aligned} \int_{\lambda_{k,n+1}}^{t_{k-1}} \frac{a_{k+n} - q_{k+n}t}{t^2 + t + 1} dt &= \int_{\lambda_{k,n+1}}^{\gamma_{k+n}} \frac{a_{k+n} - q_{k+n}t}{t^2 + t + 1} dt - \int_{t_{k-1}}^{\gamma_{k+n}} \frac{a_{k+n} - q_{k+n}t}{t^2 + t + 1} dt \\ &= \frac{(n+2)Q - q_{k+n+1}}{2Q^2q_{k-1}(q_k + q_{k+n})(\gamma^2 + \gamma + 1)} \left(\frac{q_{k+n} - nQ}{q_k + q_{k+n}} + \frac{q_{k+n} - (n+1)Q}{q_{k-1}} \right) + O\left(\frac{1}{Q^2qq_{k+n}^2}\right). \end{aligned} \quad (11.22)$$

12. APPENDIX 3

12.1. Estimates for the C_0 contribution when $(r, r_k) = (1, 0)$. Here $\lambda_{k,n}$ is as in (8.3) and $W_{\gamma,k,n}^{(1)}$ and $W_{\gamma,k}^{(2)}$ as in (8.4).

12.1.1. For $k \geq 1$ and $q_{k+1} \leq 2Q$:

$$\int_{\gamma_{k+1}}^{t_{k-1}} \frac{w_{C_k}(t) dt}{t^2 + t + 1} = \frac{(2Q - q_{k+1})^2}{2Q^2 q_{k-1} q_{k+1}^2 (\gamma^2 + \gamma + 1)} + O\left(\frac{1}{qq_{k-1}^2 q_k^2}\right). \quad (12.1)$$

$$\begin{aligned} \int_{\gamma_{k+1}}^{t_{k-1}} \frac{w_{B_k}(t) - w_{A_0}(t)}{t^2 + t + 1} dt &= \int_{\gamma_{k+1}}^{t_{k-1}} \frac{q_{k+1}t - a_{k+1}}{t^2 + t + 1} dt \\ &= \frac{(2Q - q_{k+1})^2}{2Q^2 q_{k-1}^2 q_{k+1} (\gamma^2 + \gamma + 1)} + O\left(\frac{1}{qq_{k-1}^3 q_{k+1}}\right). \end{aligned} \quad (12.2)$$

12.1.2. For $k \geq 1$ and $n(q_k - Q) \leq Q - q \leq (N+1)(q_k - Q)$:

$$\int_{\lambda_{k,n}}^{t_{k-1}} \frac{(q + nq_k)t - (a + na_k)}{t^2 + t + 1} dt = \frac{((n+1)Q - (q + nq_k))^2}{2Q^2 q_{k-1}^2 (q + nq_k) (\gamma^2 + \gamma + 1)} + O\left(\frac{1}{qq_{k-1}^3 (q + nq_k)}\right). \quad (12.3)$$

12.1.3. For $k \geq 1$ and $(n+1)(q_k - Q) \leq Q - q$:

$$\int_{\lambda_{k,n}}^{\lambda_{k,n+1}} \frac{W_{\gamma,k,n}^{(1)}(t) dt}{t^2 + t + 1} = \frac{q_{k+1} + nq_k - \xi Q}{2(q + nq_k)(q_{k+1} + nq_k)^2 (\gamma^2 + \gamma + 1)} + O_\xi\left(\frac{1}{qq_k(q + nq_k)(q_{k+1} + nq_k)}\right). \quad (12.4)$$

$$\int_{\lambda_{k,n+1}}^{t_{k-1}} \frac{dt}{t^2 + t + 1} = \frac{(n+2)Q - q_{k+1} - nq_k}{Qq_{k-1}(q_{k+1} + nq_k) (\gamma^2 + \gamma + 1)} + O\left(\frac{1}{qq_{k-1}^2 q_k}\right). \quad (12.5)$$

$$\begin{aligned} \int_{\lambda_{k,n+1}}^{t_{k-1}} \frac{w_{A_0}(t) + w_{C_k}(t)}{t^2 + t + 1} dt &= \int_{\lambda_{k,n+1}}^{\gamma_k} \frac{a_k - q_k t}{t^2 + t + 1} dt - \int_{t_{k-1}}^{\gamma_k} \frac{a_k - q_k t}{t^2 + t + 1} dt \\ &= \frac{(n+2)Q - q_{k+1} - nq_k}{2Q^2 q_{k-1} (q_{k+1} + nq_k) (\gamma^2 + \gamma + 1)} \left(\frac{Q}{q_{k+1} + nq_k} + \frac{q_k - Q}{q_{k-1}} \right) + O\left(\frac{1}{q_{k-1}^3 q_{k+1}^2}\right). \end{aligned} \quad (12.6)$$

$$\begin{aligned} \int_{\lambda_{k,n+1}}^{t_{k-1}} \frac{W_{\gamma,k}^{(2)}(t)}{t^2 + t + 1} dt &= \frac{(n+2)Q - q_{k+1} - nq_k}{2Qq_{k-1}(q_{k+1} + nq_k) (\gamma^2 + \gamma + 1)} \\ &\quad \cdot \left(\frac{q_{k+1} + nq_k - \xi Q}{q_{k+1} + nq_k} + \frac{q_{k-1} - \xi(q_k - Q)}{q_{k-1}} \right) + O_\xi\left(\frac{1}{qq_{k-1}^3}\right). \end{aligned} \quad (12.7)$$

12.2. Estimates for the C_{\leftarrow} contribution when $(r, r_k) = (1, 0)$. Here $\mu_{k,n}$ and $\nu_{k,n}$ are as in (8.7).

12.2.1. For $q_2 > 2Q$:

$$\begin{aligned} \int_{\frac{a+\varepsilon}{q}}^{\gamma_1} \frac{w_{C_0}(t) dt}{t^2 + t + 1} &= - \left(\int_{t_0}^{\gamma_1} \frac{q't - a' + 2\varepsilon}{t^2 + t + 1} dt - \int_{t_0}^{\frac{a+\varepsilon}{q}} \frac{q't - a' + 2\varepsilon}{t^2 + t + 1} dt \right) \\ &\quad + \left(\int_{\gamma}^{\gamma_1} \frac{qt - a}{t^2 + t + 1} dt - \int_{\gamma}^{\frac{a+\varepsilon}{q}} \frac{qt - a}{t^2 + t + 1} dt \right) \\ &= \frac{(2Q - q_1)^2 q_3}{8Q^2 q^2 q_1^2 (\gamma^2 + \gamma + 1)} + O\left(\frac{1}{Q^2 q^2 q'}\right). \end{aligned} \quad (12.8)$$

$$\begin{aligned} \int_{\frac{a+\varepsilon}{q}}^{\gamma_1} \frac{w_{\mathcal{A}_0}(t) dt}{t^2 + t + 1} &= \int_{\frac{a+\varepsilon}{q}}^{u_0} \frac{w_{\mathcal{A}_0}(t) dt}{t^2 + t + 1} - \int_{\gamma}^{u_0} \frac{w_{\mathcal{A}_0}(t) dt}{t^2 + t + 1} \\ &= \frac{(2Q - q_1)(3q_1 - 2Q)}{8Q^2 q q_1^2 (\gamma^2 + \gamma + 1)} + O\left(\frac{1}{Q^3 q^2}\right). \end{aligned} \quad (12.9)$$

$$\int_{\frac{a+\varepsilon}{q}}^{\gamma_1} \frac{a_1 - q_1 t}{t^2 + t + 1} dt = \frac{(2Q - q_1)^2}{8Q^2 q^2 q_1 (\gamma^2 + \gamma + 1)} + O\left(\frac{1}{q^3 Q^2}\right). \quad (12.10)$$

12.2.2. When $n = 1$ and $\frac{2(Q-q)}{n+1} \leq q_k \leq \frac{2(Q-q)}{n} \wedge \left(Q + \frac{Q-q}{n+1}\right)$:

$$\begin{aligned} \int_{t_k}^{\mu_{k,n}} \frac{w_{\mathcal{A}_0}(t) dt}{t^2 + t + 1} &= \int_{t_k}^{u_0} \frac{a + 2\varepsilon - qt}{t^2 + t + 1} dt - \int_{\mu_{k,n}}^{u_0} \frac{a + 2\varepsilon - qt}{t^2 + t + 1} dt \\ &= \frac{(n+1)q_k - 2(Q-q)}{2Q^2 q_k (2q + nq_k) (\gamma^2 + \gamma + 1)} \left(\frac{q_{k+1} - Q}{q_k} + \frac{q + nq_k - nQ}{2q + nq_k} \right) + O\left(\frac{1}{Qq^2 q_k^2}\right). \end{aligned} \quad (12.11)$$

$$\begin{aligned} \int_{t_k}^{\mu_{k,n}} \frac{w_{C_k}(t) dt}{t^2 + t + 1} &= \int_{t_k}^{t_{k-1}} \frac{a_{k-1} - 2\varepsilon - q_{k-1}t}{t^2 + t + 1} dt - \int_{\mu_{k,n}}^{t_{k-1}} \frac{a_{k-1} - 2\varepsilon - q_{k-1}t}{t^2 + t + 1} dt \\ &= \frac{(n+1)q_k - 2(Q-q)}{2Q^2 q_k (2q + nq_k) (\gamma^2 + \gamma + 1)} \left(\frac{Q-q}{q_k} + \frac{(n+2)Q - q - (n+1)q_k}{2q + nq_k} \right) + O\left(\frac{1}{Qq q_{k-1} q_k^2}\right). \end{aligned} \quad (12.12)$$

$$\int_{t_k}^{\nu_{k,n}} \frac{a + na_k - (q + nq_k)t}{t^2 + t + 1} dt = \frac{(q + nq_k - Q)^2}{2Q^2 q_k^2 (q + nq_k) (\gamma^2 + \gamma + 1)} + O\left(\frac{1}{qq_k^4}\right). \quad (12.13)$$

$$\int_{\nu_{k,n}}^{\mu_{k,n}} \frac{(q + nq_k)t - (a + na_k)}{t^2 + t + 1} dt = \frac{(q + nq_k - Q)^2}{2Q^2 (q + nq_k) (2q + nq_k)^2 (\gamma^2 + \gamma + 1)} + O\left(\frac{1}{qq_k^4}\right). \quad (12.14)$$

12.2.3. When $\frac{2(Q-q)}{n} \leq q_k \leq Q + \frac{Q-q}{n+1}$, $n, k \geq 1$:

For $n \geq 2$ we have

$$\begin{aligned} \int_{\mu_{k,n-1}}^{\mu_{k,n}} \frac{w_{\mathcal{A}_0}(t) dt}{t^2 + t + 1} &= \int_{\mu_{k,n-1}}^{u_0} \frac{a + 2\varepsilon - qt}{t^2 + t + 1} dt - \int_{\mu_{k,n}}^{u_0} \frac{a + 2\varepsilon - qt}{t^2 + t + 1} dt \\ &= \frac{2Q - q_k}{2Q^2 (2q + nq_k) (2q + (n-1)q_k) (\gamma^2 + \gamma + 1)} \left(\frac{q + (n-1)(q_k - Q)}{2q + (n-1)q_k} + \frac{q + n(q_k - Q)}{2q + nq_k} \right) \\ &\quad + O\left(\frac{1}{(n-1)^3 q^2 q_k^3}\right). \end{aligned} \quad (12.15)$$

For $n = 1$ the error can be improved (since $2Q - q_k \leq 2q$ and $\mu_{k,1} - \gamma \leq \frac{1}{qq_k}$) as follows:

$$\begin{aligned} \int_{\mu_{k,0}}^{\mu_{k,1}} \frac{w_{\mathcal{A}_0}(t) dt}{t^2 + t + 1} &= - \int_{\mu_{k,0}}^{\mu_{k,1}} \frac{qt - a - \varepsilon}{t^2 + t + 1} dt + \int_{\mu_{k,0}}^{\mu_{k,1}} \frac{\varepsilon dt}{t^2 + t + 1} \\ &= \frac{2Q - q_k}{2Q^2 (2q + q_k) (2q) (\gamma^2 + \gamma + 1)} \left(\frac{q}{2q} + \frac{q + q_k - Q}{2q + q_k} \right) + O\left(\frac{1}{Q^2 q q_k^2}\right). \end{aligned} \quad (12.16)$$

Since $0 \leq (n+1)Q - q - nq_k \leq Q - q < q'$ and $0 \leq nq_k - (n+1)Q \leq 2Q$ we find:

$$\begin{aligned} \int_{\mu_{k,n-1}}^{\mu_{k,n}} \frac{w_{C_k}(t) dt}{t^2 + t + 1} &= \int_{\mu_{k,n-1}}^{t_{k-1}} \frac{a_{k-1} - 2\varepsilon - q_{k-1}t}{t^2 + t + 1} dt - \int_{\mu_{k,n}}^{t_{k-1}} \frac{a_{k-1} - 2\varepsilon - q_{k-1}t}{t^2 + t + 1} dt \\ &= \frac{2Q - q_k}{2Q^2(2q + nq_k)(2q + (n-1)q_k)(\gamma^2 + \gamma + 1)} \end{aligned} \quad (12.17)$$

$$\cdot \left(\frac{Q - q - n(q_k - Q)}{2q + (n-1)q_k} + \frac{Q - q - (n+1)(q_k - Q)}{2q + nq_k} \right) + O\left(\frac{1}{qq_{k-1}^2(q + (n-1)q_k)^2} \right).$$

$$\begin{aligned} \int_{\mu_{k,n-1}}^{\nu_{k,n}} \frac{a + na_k - (q + nq_k)t}{t^2 + t + 1} dt &= \frac{(Q - q - n(q_k - Q))^2}{2Q^2(q + nq_k)(2q + (n-1)q_k)^2(\gamma^2 + \gamma + 1)} \\ &+ O\left(\frac{1}{nqq_k^2(q + (n-1)q_k)^2} \right). \end{aligned} \quad (12.18)$$

$$\int_{\nu_{k,n}}^{\mu_{k,n}} \frac{(q + nq_k)t - (a + na_k)}{t^2 + t + 1} dt = \frac{(q + n(q_k - Q))^2}{2Q^2(q + nq_k)(2q + nq_k)^2(\gamma^2 + \gamma + 1)} + O\left(\frac{1}{n^3qq_k^4} \right). \quad (12.19)$$

We check that the contribution of error terms is negligible. Note that when $n = 1$ we must have $2q \geq 2Q - q_k \geq 2Q - \frac{3Q-q}{2} = \frac{Q+q}{2}$, so $q \geq \frac{Q}{3}$. The errors in (12.15)-(12.19) add up to

$$\begin{aligned} &\ll \sum_{n=2}^{\infty} \sum_{k=1}^{\infty} \sum_{\gamma \in \mathcal{F}(Q)} \frac{q}{(n-1)^3 q^2 q_k^3} + \sum_{k=1}^{\infty} \sum_{\gamma \in \mathcal{F}(Q)} \frac{1}{Q^2 q_k^2} + \sum_{n=2}^{\infty} \sum_{k=1}^{\infty} \sum_{\gamma \in \mathcal{F}(Q)} \frac{q_{k+1}}{qq_{k-1}^2 q_k^2} \\ &+ \sum_{k=1}^{\infty} \sum_{\gamma \in \mathcal{F}(Q)} \frac{q_{k+1}}{q^3 q_{k-1}^2} + \sum_{n=2}^{\infty} \sum_{k=1}^{\infty} \sum_{\gamma \in \mathcal{F}(Q)} \frac{q_{k+1}}{n(n-1)^2 qq_k^4} + \sum_{k=1}^{\infty} \sum_{\gamma \in \mathcal{F}(Q)} \frac{q_{k+1}}{q^3 q_k^2} + \sum_{n=1}^{\infty} \sum_{k=1}^{\infty} \frac{1}{n^3 q_k^4} + \frac{1}{|I|} \cdot \frac{1}{Q} \\ &\ll \sum_{\gamma \in \mathcal{F}(Q)} \frac{Q}{q^3 q'^2} + \sum_{\frac{Q}{3} \leq q \leq Q} \frac{\varphi(q)}{q^3} + Q^{c-1} \ll Q^{c-1}. \end{aligned}$$

12.2.4. For $k \geq 1$ and $q_{k+2} \leq 2Q$:

$$\int_{\gamma_{k+1}}^{t_{k-1}} \frac{q_{k+1}t - a_{k+1}}{t^2 + t + 1} dt = \frac{(2Q - q_{k+1})^2}{2Q^2 q_{k-1}^2 q_{k+1} (\gamma^2 + \gamma + 1)} + O\left(\frac{1}{qq_{k-1}^3 q_{k+1}} \right). \quad (12.20)$$

12.2.5. For $n, k \geq 1$ and $\frac{2(Q-q)}{n} \vee \left(Q + \frac{Q-q}{n+1} \right) \leq q_k \leq Q + \frac{Q-q}{n}$:

$$\begin{aligned} \int_{\mu_{k,n-1}}^{t_{k-1}} \frac{w_{\mathcal{A}_0}(t) dt}{t^2 + t + 1} &= \int_{\mu_{k,n-1}}^{u_0} \frac{a + 2\varepsilon - qt}{t^2 + t + 1} dt - \int_{t_{k-1}}^{u_0} \frac{a + 2\varepsilon - qt}{t^2 + t + 1} dt \\ &= \frac{(n+1)Q - q - nq_k}{2Q^2 q_{k-1} (2q + (n-1)q_k) (\gamma^2 + \gamma + 1)} \left(\frac{q + (n-1)(q_k - Q)}{2q + (n-1)q_k} + \frac{q_k - Q}{q_{k-1}} \right) \\ &+ O\left(\frac{1}{q(2q + (n-1)q_k)^2} \left(\frac{Q-q}{Q^2 q_{k-1}} + \frac{1}{q(2q + (n-1)q_k)} \right) \right). \end{aligned} \quad (12.21)$$

When $n \geq 2$ the error is $\leq \frac{2}{q^2 q_{k-1} q_k^2}$. When $n = 1$ we can improve on the error term:

$$\begin{aligned} \int_{\mu_{k,0}}^{t_{k-1}} \frac{a + 2\varepsilon - qt}{t^2 + t + 1} dt &= - \int_{\frac{a+\varepsilon}{q}}^{t_{k-1}} \frac{a + \varepsilon - qt}{t^2 + t + 1} dt + \int_{\frac{a+\varepsilon}{q}}^{t_{k-1}} \frac{\varepsilon dt}{t^2 + t + 1} \\ &= \frac{2Q - q_{k+1}}{4Q^2 q q_{k-1} (\gamma^2 + \gamma + 1)} \left(1 - \frac{2Q - q_{k+1}}{2q_{k-1}} \right) + O\left(\frac{1}{Qq^2 q_{k-1}^2} + \frac{1}{q^2 q_{k-1}^3} + \frac{1}{Q^2 q^2 q_{k-1}} \right). \end{aligned} \quad (12.22)$$

$$\int_{\mu_{k,n-1}}^{t_{k-1}} \frac{w_{C_k}(t) dt}{t^2 + t + 1} = \frac{((n+1)Q - q - nq_k)^2}{2Q^2 q_{k-1} (2q + (n-1)q_k)^2 (\gamma^2 + \gamma + 1)} + O\left(\frac{1}{qq_{k-1}^2 (2q + (n-1)q_k)^2} \right). \quad (12.23)$$

$$\int_{\mu_{k,n-1}}^{\nu_{k,n}} \frac{a + na_k - (q + nq_k)t}{t^2 + t + 1} dt = \frac{((n+1)Q - q - nq_k)^2}{2Q^2 (q + nq_k) (2q + (n-1)q_k)^2 (\gamma^2 + \gamma + 1)} + O\left(\frac{1}{q^3 q_k^2} \right). \quad (12.24)$$

$$\int_{\nu_{k,n}}^{t_{k-1}} \frac{(q + nq_k)t - (a + na_k)}{t^2 + t + 1} dt = \frac{((n+1)Q - q - nq_k)^2}{2Q^2 q_{k-1}^2 (q + nq_k) (\gamma^2 + \gamma + 1)} + O\left(\frac{1}{Q^2 q q_k^2} \right). \quad (12.25)$$

13. APPENDIX 4

When $k \geq 1$ and $q_{k+1} \leq 2Q$:

$$\begin{aligned} \int_{t_k}^{\gamma_{k+1}} \frac{w_{C_k}(t) dt}{t^2 + t + 1} &= \int_{t_k}^{t_{k-1}} \frac{a_{k-1} - 2\varepsilon - q_{k-1}t}{t^2 + t + 1} dt - \int_{\gamma_{k+1}}^{t_{k-1}} \frac{a_{k-1} - 2\varepsilon - q_{k-1}t}{t^2 + t + 1} dt \\ &= \frac{q_{k+1} - Q}{2Q^2 q_k q_{k+1} (\gamma^2 + \gamma + 1)} \left(\frac{Q - q}{q_k} + \frac{2Q - q_{k+1}}{q_{k+1}} \right) + O\left(\frac{1}{qq_{k-1} q_k^3} \right). \end{aligned} \quad (13.1)$$

$$\begin{aligned} \int_{\gamma_{k+1}}^{t_{k-1}} \frac{w_{\mathcal{A}_0}(t) dt}{t^2 + t + 1} &= \int_{\gamma_{k+1}}^{u_0} \frac{a + 2\varepsilon - qt}{t^2 + t + 1} dt - \int_{t_{k-1}}^{u_0} \frac{a + 2\varepsilon - qt}{t^2 + t + 1} dt \\ &= \frac{2Q - q_{k+1}}{2Q^2 q_{k-1} q_{k+1}} \left(\frac{q_{k+1} - Q}{q_{k+1}} + \frac{q_k - Q}{q_{k-1}} \right) + O\left(\frac{1}{q^3 q_{k+1}^2} \right). \end{aligned} \quad (13.2)$$

When $q_{k+1} > 2Q$:

$$\begin{aligned} \int_{t_k}^{\gamma_{k+1}} \frac{2(a + \varepsilon - qt) dt}{t^2 + t + 1} &= - \left(\int_{\gamma}^{\gamma_{k+1}} \frac{qt - a}{t^2 + t + 1} dt - \int_{\gamma}^{t_k} \frac{qt - a}{t^2 + t + 1} dt \right) + \int_{t_k}^{\gamma_{k+1}} \frac{2\varepsilon dt}{t^2 + t + 1} \\ &= \frac{q_{k+1} - Q}{2Q^2 q_k q_{k+1} (\gamma^2 + \gamma + 1)} \left(\frac{q_{k+2} - 2Q}{q_k} + \frac{q_{k+1} - 2Q}{q_{k+1}} \right) + O\left(\frac{1}{q^3 q_k^2} \right). \end{aligned} \quad (13.3)$$

13.1. Estimates for the C_O and the C_{\leftarrow} contributions when $(r, r_k) = (1, -1)$ and $w_{\mathcal{A}_0} > w_{\mathcal{B}_k}$. Here $\lambda_{k,n}$ is as in (9.3).

13.1.1. If $Q + \frac{Q-q}{n+1} \leq q_{k+1} \leq 2Q$ and $k \geq 1$, then

$$\begin{aligned} \int_{\lambda_{k,n+1}}^{\gamma_{k+1}} \frac{w_{C_k}(t) dt}{t^2 + t + 1} &= \int_{\lambda_{k,n+1}}^{t_{k-1}} \frac{a_{k-1} - 2\varepsilon - q_{k-1}t}{t^2 + t + 1} dt - \int_{\gamma_{k+1}}^{t_{k-1}} \frac{a_{k-1} - 2\varepsilon - q_{k-1}t}{t^2 + t + 1} dt \\ &= \frac{2Q - q_{k+1}}{2Q^2 q_{k+1} (nq_{k+1} + 2q) (\gamma^2 + \gamma + 1)} \left(\frac{(n+1)(2Q - q_{k+1})}{nq_{k+1} + 2q} + \frac{2Q - q_{k+1}}{q_{k+1}} \right) + O\left(\frac{1}{qq_{k-1}^2 q_{k+1}^2} \right). \end{aligned} \quad (13.4)$$

When $k = 0$ one can improve on the error as follows:

$$\begin{aligned} \int_{\lambda_{0,n+1}}^{\gamma_1} \frac{w_{C_0}(t) dt}{t^2 + t + 1} &= - \left(\int_{t_0}^{\gamma_1} \frac{q't - a' + 2\varepsilon}{t^2 + t + 1} dt - \int_{t_0}^{\lambda_{0,n+1}} \frac{q't - a' + 2\varepsilon}{t^2 + t + 1} dt \right) \\ &\quad + \left(\int_{\gamma}^{\gamma_1} \frac{qt - a}{t^2 + t + 1} dt - \int_{\gamma}^{\lambda_{0,n+1}} \frac{qt - a}{t^2 + t + 1} dt \right) \\ &= \frac{2Q - q_1}{2Q^2 q_1 (nq_1 + 2q)(\gamma^2 + \gamma + 1)} \left(\frac{(n+1)(2Q - q_1)}{nq_1 + 2q} + \frac{2Q - q_1}{q_1} \right) + O\left(\frac{1}{Q^2 q^2 q'}\right). \end{aligned} \quad (13.5)$$

13.1.2. When $n \geq 1$ and $Q + \frac{Q-q}{n+1} \leq q_{k+1} \leq 2Q$:

$$\int_{\lambda_{k,n+1}}^{\gamma_{k+1}} \frac{w_{\mathcal{A}_0}(t) - w_{\mathcal{B}_k}(t)}{t^2 + t + 1} dt = \frac{(2Q - q_{k+1})^2}{2Q^2 q_{k+1} (nq_{k+1} + 2q)^2 (\gamma^2 + \gamma + 1)} + O\left(\frac{1}{qq_{k+1}^4}\right). \quad (13.6)$$

$$\begin{aligned} \int_{\lambda_{k,n}}^{\lambda_{k,n+1}} \frac{(nq_{k+1} - q_{k-1})t - na_{k+1} + a_{k-1} - 2\varepsilon}{t^2 + t + 1} dt \\ = \frac{(2Q - q_{k+1})^2}{2Q^2 (nq_{k+1} + 2q)^2 ((n-1)q_{k+1} + 2q)(\gamma^2 + \gamma + 1)} + O\left(\frac{1}{Qq^2 q_{k+1}^2}\right). \end{aligned} \quad (13.7)$$

13.1.3. When $n \geq 1$ and $Q + \frac{Q-q}{n+1} \leq q_{k+1} \leq Q + \frac{Q-q}{n}$ we have $0 \leq (n+1)(q_{k+1} - Q) + q - Q \leq \frac{Q-q}{n}$ and

$$\begin{aligned} \int_{t_k}^{\lambda_{k,n+1}} \frac{(n+1)a_{k+1} - a_{k-1} + 2\varepsilon - ((n+1)q_{k+1} - q_{k-1})t}{t^2 + t + 1} dt \\ = \frac{((n+1)(q_{k+1} - Q) + q - Q)^2}{2Q^2 q_k^2 (nq_{k+1} + 2q)(\gamma^2 + \gamma + 1)} + O\left(\frac{1}{n^4 qq_k^2 q_{k+1}^2}\right). \end{aligned} \quad (13.8)$$

$$\begin{aligned} \int_{t_k}^{\lambda_{k,n+1}} \frac{(nq_{k+1} - q_{k-1})t - na_{k+1} + a_{k-1} - 2\varepsilon}{t^2 + t + 1} dt &= \int_{\lambda_{k,n}}^{\lambda_{k,n+1}} \dots - \int_{\lambda_{k,n}}^{t_k} \dots \\ &= \frac{(n+1)(q_{k+1} - Q) + q - Q}{2Q^2 q_k (nq_{k+1} + 2q)(\gamma^2 + \gamma + 1)} \left(\frac{2Q - q_{k+1}}{nq_{k+1} + 2q} + \frac{Q - q - n(q_{k+1} - Q)}{q_k} \right) + O\left(\frac{1}{n^2 Qqq_k q_{k+1}^2}\right). \end{aligned} \quad (13.9)$$

13.1.4. When $n \geq 1$ and $Q + \frac{Q-q}{n} \leq q_{k+1} \leq 2Q$:

$$\begin{aligned} \int_{\lambda_{k,n}}^{\lambda_{k,n+1}} \frac{(n+1)a_{k+1} - a_{k-1} + 2\varepsilon - ((n+1)q_{k+1} - q_{k-1})t}{t^2 + t + 1} dt \\ = \frac{(2Q - q_{k+1})^2}{2Q^2 (nq_{k+1} + 2q)((n-1)q_{k+1} + 2q)^2 (\gamma^2 + \gamma + 1)} + O\left(\frac{1}{(n^2 - n + 1)q^3 q_{k+1}^2}\right). \end{aligned} \quad (13.10)$$

$$\begin{aligned} \int_{\lambda_{k,n}}^{\lambda_{k,n+1}} \frac{(nq_{k+1} - q_{k-1})t - na_{k+1} + a_{k-1} - 2\varepsilon}{t^2 + t + 1} dt \\ = \frac{(2Q - q_{k+1})^2}{2Q^2 (nq_{k+1} + 2q)^2 ((n-1)q_{k+1} + 2q)(\gamma^2 + \gamma + 1)} + O\left(\frac{1}{n^2 Qq^2 q_{k+1}^2}\right). \end{aligned} \quad (13.11)$$

13.2. Estimates for the C_O and the C_\downarrow contributions when $(r, r_k) = (1, -1)$ and $w_{\mathcal{A}_0} < w_{\mathcal{B}_k}$. Here we take $\lambda_{k,n}$ as in (9.8), $k \geq 1$ and $q_{k+1} \leq 2Q$.

$$\begin{aligned} \int_{\gamma_{k+1}}^{\lambda_{k,n+1}} \frac{w_{C_k}(t) dt}{t^2 + t + 1} &= \int_{\gamma_{k+1}}^{t_{k-1}} \frac{a_{k-1} - 2\varepsilon - q_{k-1}t}{t^2 + t + 1} dt - \int_{\lambda_{k,n+1}}^{t_{k-1}} \frac{a_{k-1} - 2\varepsilon - q_{k-1}t}{t^2 + t + 1} dt \\ &= \frac{(2Q - q_{k+1})^2((2n+2)q_{k+1} + q_{k-1})}{2Q^2 q_{k+1}^2 ((n+1)q_{k+1} + q_{k-1})^2 (\gamma^2 + \gamma + 1)} + O\left(\frac{1}{qq_{k-1}^2 q_{k+1}^2}\right). \end{aligned} \quad (13.12)$$

$$\begin{aligned} \int_{\gamma_{k+1}}^{\lambda_{k,n+1}} \frac{w_{\mathcal{B}_k}(t) - w_{\mathcal{A}_0}(t)}{t^2 + t + 1} dt &= \int_{\gamma_{k+1}}^{\lambda_{k,n+1}} \frac{q_{k+1}t - a_{k+1}}{t^2 + t + 1} dt \\ &= \frac{(2Q - q_{k+1})^2}{2Q^2 q_{k+1} ((n+1)q_{k+1} + q_{k-1})^2 (\gamma^2 + \gamma + 1)} + O\left(\frac{1}{qq_{k+1}^4}\right). \end{aligned} \quad (13.13)$$

$$\begin{aligned} \int_{\lambda_{k,n+1}}^{\lambda_{k,n}} \frac{na_{k+1} + a_{k-1} - 2\varepsilon - (nq_{k+1} + q_{k-1})t}{t^2 + t + 1} dt \\ = \frac{(2Q - q_{k+1})^2}{2Q^2 (nq_{k+1} + q_{k-1}) ((n+1)q_{k+1} + q_{k-1})^2 (\gamma^2 + \gamma + 1)} + O\left(\frac{1}{(n^3 + 1)qq_{k-1}^2 q_{k+1}^2}\right). \end{aligned} \quad (13.14)$$

$$\begin{aligned} \int_{\lambda_{k,n+1}}^{\lambda_{k,n}} \frac{((n+1)q_{k+1} + q_{k-1})t - (n+1)a_{k+1} - a_{k-1} + 2\varepsilon}{t^2 + t + 1} dt \\ = \frac{(2Q - q_{k+1})^2}{2Q^2 (nq_{k+1} + q_{k-1})^2 ((n+1)q_{k+1} + q_{k-1}) (\gamma^2 + \gamma + 1)} + O\left(\frac{1}{(n^3 + 1)qq_{k-1}^2 q_{k+1}^2}\right). \end{aligned} \quad (13.15)$$

REFERENCES

- [1] S. Blank and N. Krikorian, *Thom's problem on irrational flows*, Internat. J. Math. **4** (1993), 721–726.
- [2] F. P. Boca, C. Cobeli and A. Zaharescu, *Distribution of lattice points visible from the origin*, Comm. Math. Phys. **213** (2000), 433–470.
- [3] F. P. Boca and R. N. Gologan, *On the distribution of the free path length of the linear flow in a honeycomb*, Ann. Inst. Fourier **59** (2009), 1043–1075.
- [4] F. P. Boca, R. N. Gologan and A. Zaharescu, *The average length of a trajectory in a certain billiard in a flat two-torus*, New York J. Math. **9** (2003), 303–330.
- [5] F. P. Boca, R. N. Gologan and A. Zaharescu, *The statistics of the trajectory of a billiard in a flat two-torus*, Comm. Math. Phys. **240** (2003), 53–73.
- [6] F. P. Boca and A. Zaharescu, *On the correlations of directions in the Euclidean plane*, Trans. Amer. Math. Soc. **358** (2006), 1797–1825.
- [7] F. P. Boca and A. Zaharescu, *The distribution of the free path lengths in the periodic two-dimensional Lorentz gas in the small-scatterer limit*, Comm. Math. Phys. **269** (2007), 425–471.
- [8] J. Bourgain, F. Golse and B. Wennberg, *On the distribution of free path lengths for the periodic Lorentz gas*, Comm. Math. Phys. **190** (1998), 491–508.
- [9] E. Caglioti and F. Golse, *On the distribution of free path lengths for the periodic Lorentz gas. III*, Comm. Math. Phys. **236** (2003), 199–221.
- [10] E. Caglioti and F. Golse, *The Boltzmann-Grad limit of the periodic Lorentz gas in two space dimensions*, C. R. Math. Acad. Sci. Paris **346** (2008), 477–482.
- [11] P. Dahlqvist, *The Lyapunov exponent in the Sinai billiard in the small scatterer limit*, Nonlinearity **10** (1997), 159–173.
- [12] F. Golse, *The periodic Lorentz gas in the Boltzmann-Grad limit*, Proc. ICM (Madrid, 2006), vol. 3, EMS, Zürich 2006, pp. 183–201.

- [13] F. Golse, *Recent results on the periodic Lorentz gas*, preprint arXiv:0906.0191.
- [14] H. A. Lorentz, *Le mouvement des électrons dans les métaux*. Arch. Néerl. **10** (1905), p. 336. Reprinted in *Collected papers*, Vol. **3**, The Hague: Martinus Nijhoff, 1936.
- [15] J. Marklof, *Kinetic transport in crystals*, preprint math-ph/0909.3463, Proceedings of the XVIth International Congress of Mathematical Physics, Prague 2009.
- [16] J. Marklof and A. Strömbergsson, *The distribution of free path lengths in the periodic Lorentz gas and related lattice point problems*, preprint arXiv:0706.4395, to appear in Ann. Math.
- [17] J. Marklof and A. Strömbergsson, *The Boltzmann-Grad limit of the periodic Lorentz gas*, preprint arXiv:0801.0612, to appear in Ann. Math.
- [18] J. Marklof and A. Strömbergsson, *Kinetic transport in the two-dimensional periodic Lorentz gas*, Nonlinearity **21** (2008), 1413–1422.
- [19] G. Pólya, *Zahlentheoretisches und wahrscheinlichkeitstheoretisches über die sichtweite im walde*, Arch. Math. Phys. **27** (1918), 135–142.
- [20] J. Smillie, C. Ulcigrai, *Symbolic coding for linear trajectories in the regular octagon*, preprint math.DS/0905.0871.

DEPARTMENT OF MATHEMATICS, UNIVERSITY OF ILLINOIS, 1409 W. GREEN STREET, URBANA, IL 61801, USA

INSTITUTE OF MATHEMATICS OF THE ROMANIAN ACADEMY, P.O. Box 1-764, RO-014700 BUCHAREST, ROMANIA
E-mail address: fboca@illinois.edu