

DIAMOND REPRESENTATIONS OF RANK TWO SEMISIMPLE LIE ALGEBRAS

BOUJEMAA AGREBAOUI, DIDIER ARNAL AND OLFA KHLIFI

ABSTRACT. The present work is a part of a larger program to construct explicit combinatorial models for the (indecomposable) regular representation of the nilpotent factor N in the Iwasawa decomposition of a semi-simple Lie algebra \mathfrak{g} , using the restrictions to N of the simple finite dimensional modules of \mathfrak{g} .

Such a description is given in [ABW], for the cas $\mathfrak{g} = \mathfrak{sl}(n)$. Here, we give the analog for the rank 2 semi simple Lie algebras (of type $A_1 \times A_1$, A_2 , C_2 and G_2). The algebra $\mathbb{C}[N]$ of polynomial functions on N is a quotient, called reduced shape algebra of the shape algebra for \mathfrak{g} . Basis for the shape algebra are known, for instance the so called semi standard Young tableaux (see [ADLMPPrW]). We select among the semi standard tableaux, the so called quasi standard ones which define a kind basis for the reduced shape algebra.

1. INTRODUCTION

We will study the diamond cone of representations for the nilpotent factor N^+ of any rank 2 semi simple Lie algebra \mathfrak{g} . This is the indecomposable regular representation onto $\mathbb{C}[N^-]$, described from explicit realizations of the restrictions to N^- of the simple \mathfrak{g} -modules V^λ .

In [ABW], this description is explicitly given in the case $\mathfrak{g} = \mathfrak{sl}(n)$, using the notion of quasi standard Young tableaux. Roughly speaking, a quasi standard Young tableau is an usual semi standard Young tableau such that, it is impossible to extract the top of the first column, either because this top of column is not ‘trivial’, *i.e.* it does not consist of numbers $1, 2, \dots, k$, or because, when we push out this top by pushing the k first rows of the tableau, we do not get a semi standard tableau.

1991 *Mathematics Subject Classification.* 05E10, 05A15, 17B10.

Key words and phrases. rank two semisimple Lie algebras, representations, Young tableaux.

This work was supported by the CMCU contract 06/S 1502 (Partenariat Hubert Curien Utique), O. Khlifi thanks the Université de Bourgogne and D. Arnal thanks the Faculté des Sciences de Sfax for their kind hospitalities they received during their visits.

Let us come back for the case of rank 2 Lie algebra \mathfrak{g} . The modules V^λ have well known explicit realizations (see for instance [FH]). They are characterized by their highest weight $\lambda = a\omega_1 + b\omega_2$. In [ADLMPPrW], there is a construction for a basis for each V^λ , as the collection of all semi standard tableaux with shape (a, b) . The definition and construction of semi standard tableaux for \mathfrak{g} uses the notion of grid poset and their ideals. It is possible to perform compositions of grid posets, the ideals of these compositions (of a grid posets associated to V^{ω_1} and b grid posets associated to V^{ω_2}) give a basis for V^λ if $\lambda = a\omega_1 + b\omega_2$.

Thus, we realize the Lie algebra \mathfrak{g} as a subalgebra of $\mathfrak{sl}(n)$ (with $n = 4, 3, 4, 7$), and we recall the notion of shape algebra for \mathfrak{g} , it is the direct sum of all the V^λ , but we can see it as the algebra $\mathbb{C}[G]^{N^+}$ of all the polynomial functions on the group G corresponding to \mathfrak{g} , which are invariant under right action by N^+ . This gives a very concrete interpretation of the semi standard tableaux for \mathfrak{g} .

The algebra $\mathbb{C}[N^-]$ is the restriction to N^- of the functions in $\mathbb{C}[G]$. But it is also a quotient of the shape algebra by the ideal generated by $\begin{bmatrix} 1 \\ 2 \end{bmatrix} - 1, \begin{bmatrix} 1 \end{bmatrix} - 1$. We call this quotient the reduced shape algebra for \mathfrak{g} . To give a basis for this quotient, we define, case by case, the quasi standard tableaux for \mathfrak{g} . They are semi standard Young tableaux, with an extra condition, which is very similar to the condition given in the $\mathfrak{sl}(n)$ case. We prove the quasi standard Young tableaux give a kind basis for the reduced shape algebra.

2. SEMI STANDARD YOUNG TABLEAUX - QUASI STANDARD YOUNG TABLEAUX OF $SL(n)$

2.1. Semi standard Young tableaux.

Recall that the Lie algebra $\mathfrak{sl}(n) = \mathfrak{sl}(n, \mathbb{C})$ is the set of $n \times n$ traceless matrices, it is the Lie algebra of the Lie group $SL(n)$ of $n \times n$ matrices, with determinant 1.

Denote N^+ the subgroup of all the matrices $n^+ = \begin{pmatrix} 1 & & * \\ & \ddots & \\ 0 & & 1 \end{pmatrix}$. Let us con-

sider the algebra $\mathbb{C}[SL(n)]^{N^+}$ of polynomial functions on the group $SL(n)$, which are invariant under the right multiplication by the subgroup N^+ .

Example 2.1.

Let $k < n$ and $1 \leq i_1 < i_2 < \dots < i_k \leq n$. We define :

$$\begin{array}{|c|} \hline i_1 \\ \hline i_2 \\ \hline \vdots \\ \hline i_k \\ \hline \end{array} : SL(n) \longrightarrow \mathbb{C}$$

$$g \longmapsto \det(\text{submatrix}(g, (i_1 \dots i_k, 1 \dots k)))$$

i.e. for an element $g \in SL(n)$, we associate the polynomial function which is the determinant of the submatrix of g obtained by considering the k first columns of g and the rows i_1, \dots, i_k .

If k is fixed, $SL(n)$ acts on the vector space of all columns $\begin{array}{|c|} \hline i_1 \\ \hline i_2 \\ \hline \vdots \\ \hline i_k \\ \hline \end{array}$ as on $\wedge^k \mathbb{C}^n$.

Thus we look for $Sym^\bullet(\wedge \mathbb{C}^n) = Sym^\bullet(\mathbb{C}^n \oplus \wedge^2 \mathbb{C}^n \oplus \dots \oplus \wedge^{n-1} \mathbb{C}^n)$. A basis for this algebra is given by the Young tableaux

$$\begin{array}{|c|c|c|c|} \hline i_1^1 & i_1^2 & \dots & i_1^r \\ \hline \vdots & \vdots & \vdots & \\ \hline & i_{k_2}^2 & & \\ \hline i_{k_1}^1 & & & \\ \hline \end{array}$$

such that $k_1 \geq k_2 \geq \dots \geq k_r$ and if $k_j = k_{j+1}$ then $\begin{pmatrix} i_1^j \\ \vdots \\ i_{k_j}^j \end{pmatrix} \leq \begin{pmatrix} i_1^{j+1} \\ \vdots \\ i_{k_j}^{j+1} \end{pmatrix}$ for the

lexicographic ordering.

Recall now that the fundamental representations of $\mathfrak{sl}(n)$ are the natural ones on $\mathbb{C}^n, \wedge^2 \mathbb{C}^n, \dots, \wedge^{n-1} \mathbb{C}^n$ and they have highest weights $\omega_1, \dots, \omega_{n-1}$.

From a Borel-Weyl theorem, we obtain that each simple $\mathfrak{sl}(n)$ -module has a highest weight λ , there are non negative integral numbers a_1, \dots, a_{n-1} such that

$$\lambda = a_1 \omega_1 + \dots + a_{n-1} \omega_{n-1}$$

and this highest weight characterizes the module. Note \mathbb{S}^λ (or $\Gamma_{a_1, \dots, a_{n-1}}$) this module, it is a submodule of the tensor product

$$Sym^{a_1}(\mathbb{C}^n) \otimes Sym^{a_2}(\wedge^2 \mathbb{C}^n) \otimes \dots \otimes Sym^{a_{n-1}}(\wedge^{n-1} \mathbb{C}^n).$$

The direct sum \mathbb{S}^\bullet of all the simple modules \mathbb{S}^λ is the shape algebra of $SL(n)$. As an algebra, it is isomorphic to $\mathbb{C}[SL(n)]^{N^+}$ (see [FH]).

Now, we have a natural mapping from $Sym^\bullet(\mathbb{C}^n \oplus \wedge^2 \mathbb{C}^n \oplus \dots \oplus \wedge^{n-1} \mathbb{C}^n)$ onto $\mathbb{C}[SL(n)]^{N^+}$ which is just the evaluation map:

$$\begin{array}{|c|c|c|c|} \hline i_1^1 & i_1^2 & \dots & i_1^r \\ \hline \vdots & \vdots & & \vdots \\ \hline & i_{k_2}^2 & & \\ \hline i_{k_1}^1 & & & \\ \hline \end{array} \mapsto \left(g \mapsto \begin{array}{|c|} \hline i_1^1 \\ \hline \vdots \\ \hline i_{k_1}^1 \\ \hline \end{array} (g) \cdot \begin{array}{|c|} \hline i_1^2 \\ \hline \vdots \\ \hline i_{k_2}^2 \\ \hline \end{array} (g) \dots \begin{array}{|c|} \hline i_1^r \\ \hline \end{array} (g) \right).$$

Thanks to the Gauss method, all the N^+ right invariant polynomial functions on

$SL(n)$ are polynomial functions in the polynomials $\begin{array}{|c|} \hline i_1 \\ \hline i_2 \\ \hline \vdots \\ \hline i_k \\ \hline \end{array}$, thus :

Proposition 2.2.

The map from $Sym^\bullet(\wedge \mathbb{C}^n) = Sym^\bullet(\mathbb{C}^n \oplus \wedge^2 \mathbb{C}^n \oplus \dots \oplus \wedge^{n-1} \mathbb{C}^n)$ onto $\mathbb{S}^\bullet = \mathbb{C}[SL(n)]^{N^+}$ is a surjective mapping.

Definition 2.3.

A Young tableau of shape λ is **semi standard** if its entries are increasing along each row (and strictly increasing along each column).

Definition 2.4.

Let T be a tableau. If T contains a_i columns with height i ($i = 1, \dots, n-1$), we call shape of T the $(n-1)$ -uplet $\lambda(T) = (a_1, \dots, a_{n-1})$. We consider the partial ordering on the family of shapes $\mu = (b_1, \dots, b_{n-1}) \leq \lambda = (a_1, \dots, a_{n-1})$ if and only if

$$b_1 \leq a_1, \dots, b_{n-1} \leq a_{n-1}.$$

Theorem 2.5.

- 1) The algebra $\mathbb{S}^\bullet = \bigoplus_\lambda \mathbb{S}^\lambda$, is isomorphic to the quotient of $Sym^\bullet(\wedge \mathbb{C}^n)$ by the kernel \mathcal{PL} of the evaluation mapping. This ideal is generated by the Plücker relations.
- 2) If $\lambda = a_1 \omega_1 + \dots + a_{n-1} \omega_{n-1}$, a basis for \mathbb{S}^λ is given by the set of semi standard Young tableaux T of shape λ .

Example 2.6. The $\mathfrak{sl}(3)$ case

We have one and only one Plücker relation:

$$\begin{array}{|c|c|} \hline 1 & 3 \\ \hline 2 & \\ \hline \end{array} - \begin{array}{|c|c|} \hline 2 & 1 \\ \hline 3 & \\ \hline \end{array} + \begin{array}{|c|c|} \hline 1 & 2 \\ \hline 3 & \\ \hline \end{array} = 0.$$

Then to obtain a basis for the algebra \mathbb{S}^\bullet , we reject exactly the non semi standard Young tableaux : the tableaux which contain $\begin{array}{|c|c|} \hline 2 & 1 \\ \hline 3 & \\ \hline \end{array}$ as a subtableau.

The Cartan subalgebra \mathfrak{h} of $\mathfrak{sl}(n)$ is the $(n-1)$ dimensional vector space consisting of diagonal, traceless matrices $H = (h_{ij})$. The usual basis $(\alpha_1, \dots, \alpha_{n-1})$ of \mathfrak{h}^* is given by simple roots $\alpha_i = \lambda_i - \lambda_{i+1}$ where $\lambda_i(H) = h_{ii}$.

\mathfrak{h}^* is an Euclidean vector space with a scalar product given by the Killing form. We shall draw pictures in the real vector space $\mathfrak{h}_{\mathbb{R}}^*$ generated by α_i .

For $\mathfrak{sl}(3)$, we note $\alpha = \alpha_1$ and $\beta = \alpha_2$.

Following [ABW], we look at the action of the nilpotent group ${}^tN^+$ onto the highest weight vector v_λ in \mathbb{S}^λ . This action generates the representation space \mathbb{S}^λ . Thus, as basis for the dual of the Cartan subalgebra, we choose the simple negative roots.

The action of $X_{-\alpha}$ on a weight vector is pictured by an arrow $\xrightarrow{\alpha}$.

Example 2.7.

With the convention above, we get the following weight diagrams of $\Gamma_{a,b}$ for $\mathfrak{sl}(3)$, for $a + b \leq 2$:

$\Gamma_{0,0} :$	$\overset{\circ}{0}$
$\Gamma_{1,0} :$	
$\Gamma_{0,1} :$	
$\Gamma_{2,0} :$	
$\Gamma_{0,2} :$	
$\Gamma_{1,1} :$	

2.2. Quasi standard Young tableaux for $\mathfrak{sl}(n)$.

We now are interested by the restriction of polynomial functions on $SL(n)$ to the subgroup $N^- = {}^tN^+$. This restriction leads to an exact sequence: (see [ABW])

$$0 \longrightarrow \left\langle \begin{array}{|c|} \hline 1 \\ \hline 2 \\ \hline \vdots \\ \hline k \\ \hline \end{array} - 1, k = 1, \dots, n - 1 \right\rangle \longrightarrow \mathbb{C}[SL(n)]^{N^+} \longrightarrow \mathbb{C}[N^-] \longrightarrow 0.$$

($\langle w_k \rangle$ denotes the ideal generated by the w_k).

Or :

$$0 \longrightarrow \left\langle \begin{array}{|c|} \hline 1 \\ \hline 2 \\ \hline \vdots \\ \hline k \\ \hline \end{array} - 1 \right\rangle + \mathcal{PL} = \mathcal{PL}_{red} \longrightarrow Sym^\bullet(\bigwedge \mathbb{C}^n) \longrightarrow \mathbb{C}[N^-] \longrightarrow 0.$$

For instance, in $SL(3)$, the Plücker relation becomes in \mathcal{PL}_{red} :

$$\boxed{3} - \begin{array}{|c|} \hline 2 \\ \hline 3 \\ \hline \end{array} + \begin{array}{|c|c|} \hline 1 & 2 \\ \hline 3 & \\ \hline \end{array} = 0.$$

Now, we look for a basis for $\mathbb{C}[N^-]$, by selecting some semi standard Young tableaux.

Definition 2.8.

Let T be a semi standard Young tableau such that its first column begins by $\begin{array}{|c|} \hline 1 \\ \hline 2 \\ \hline \vdots \\ \hline k \\ \hline \vdots \\ \hline \end{array}$.

We say that we can "push" T if we shift the k firsts rows of T to the left and we

delete the column $\begin{array}{|c|} \hline 1 \\ \hline 2 \\ \hline \vdots \\ \hline k \\ \hline \end{array}$ which spill out. We denote by $P(T)$ the new tableau obtained.

A tableau T is said **quasi standard** if T is a semi standard Young tableau and $P(T)$ is not a semi standard tableau.

Example 2.9. The $\mathfrak{sl}(3)$ case

The tableaux

$$\begin{array}{|c|c|} \hline 2 & 1 \\ \hline 3 & \\ \hline \end{array}, \begin{array}{|c|c|} \hline 1 & 3 \\ \hline 2 & \\ \hline \end{array} \text{ and } \begin{array}{|c|c|} \hline 1 & 2 \\ \hline 3 & \\ \hline \end{array}$$

are not quasi standards, but the tableaux

$$\boxed{3} \quad \text{and} \quad \begin{array}{|c|} \hline 2 \\ \hline 3 \\ \hline \end{array}$$

are quasi standard.

To find a basis of $\mathbb{C}[N^-]$, adapted to representations of $SL(n)$, we restrict ourselves to quasi standard Young tableaux.

Theorem 2.10.

The set of quasi standard Young tableaux form a basis for the algebra $\mathbb{C}[N^-]$.

Let us denote π the canonical mapping :

$$\pi : \mathbb{S}^\bullet = \text{Sym}^\bullet(\bigwedge \mathbb{C}^n) / \mathcal{PL} \longrightarrow \mathbb{C}[N^-] = \text{Sym}^\bullet(\bigwedge \mathbb{C}^n) / \mathcal{PL}_{red}.$$

The algebra of polynomial functions on N^- is an indecomposable N^+ -module. Indeed, the action of N^+ on $\mathbb{C}[N^-]$ is defined by :

$$n^+ f(n^-) = f({}^t n^+ n^-).$$

Each module $\pi(\mathbb{S}^\lambda) = \mathbb{S}^\lambda_{|N^-}$ is occurring in $\mathbb{C}[N^-]$.

$\pi(\mathbb{S}^\lambda)$ is generated by the lowest weight vector $\pi(w_\lambda)$ (we say it is a monogenic module). Suppose $\lambda = a_1\omega_1 + \dots + a_{n-1}\omega_{n-1}$, for each simple root α_i , we have :

$$X_{\alpha_i}^{a_i} \pi(w_\lambda) \neq 0 \quad \text{and} \quad X_{\alpha_i}^{a_i+1} \pi(w_\lambda) = 0.$$

Moreover, if W is any monogenic, finite dimensional, N^+ module generated by a vector w , for which the X_{α_i} are nilpotent, and if the integral numbers a_i are defined by :

$$X_{\alpha_i}^{a_i} w \neq 0 \quad \text{and} \quad X_{\alpha_i}^{a_i+1} w = 0,$$

then W is isomorphic to a quotient of $\pi(\mathbb{S}^\lambda)$. The result in [ABW] is :

Proposition 2.11.

A parametrization of a basis for the quotient $\pi(\mathbb{S}^\lambda) = \mathbb{S}^\lambda_{|N^+}$ is given by the set of quasi standard Young tableaux of shape $\leq \lambda$.

Example 2.12.

For the Lie algebra $\mathfrak{sl}(3)$, we get the picture :

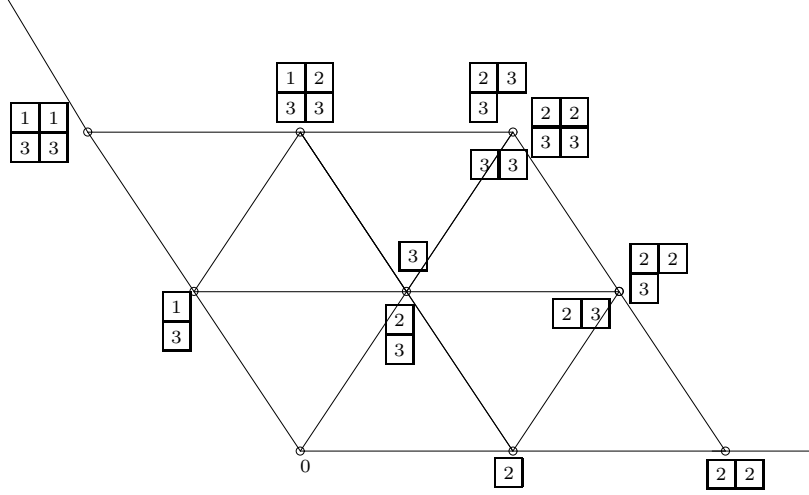

3. PRINCIPLE OF OUR CONSTRUCTION. FUNDAMENTAL REPRESENTATIONS

The purpose of this article is to address in the same way the rank two semisimple Lie algebras. We will describe first the semi standard Young tableaux for the algebras $A_1 \times A_1, A_2, C_2$ and G_2 then the quasi standard Young tableaux for these algebras. For this, we start to realize the rank two semisimple Lie algebras as subalgebras of $\mathfrak{sl}(n)$ for $n = 4, 3, 4, 7$ in such a way that the simples coroots $X_{-\alpha}$ and $X_{-\beta}$ (α denotes the first "short" simple root and β denotes the second "long" simple root) are matrices such as :

$$\begin{aligned}
 tX_{-\alpha} &\mapsto \text{first column of } tX_{-\alpha} \\
 tX_{-\alpha} + sX_{-\beta} &\mapsto \text{two firsts columns of } tX_{-\alpha} + sX_{-\beta}
 \end{aligned}
 \tag{*}$$

are one-to-one.
 Explicitely, we take the following realizations:

$A_1 \times A_1 = \mathfrak{sl}(2) \times \mathfrak{sl}(2) :$

Let $(g_1, g_2) \in \mathfrak{sl}(2) \times \mathfrak{sl}(2)$ where $g_i = \begin{pmatrix} a_i & b_i \\ c_i & d_i \end{pmatrix}$ such that $a_i + d_i = 0$. We thus modify

the natural realization of the Lie algebra $A_1 \times A_1$ as :

$$X = \begin{pmatrix} a_1 & b_1 & 0 & 0 \\ c_1 & d_1 & 0 & 0 \\ 0 & 0 & a_2 & b_2 \\ 0 & 0 & c_2 & d_2 \end{pmatrix} \mapsto \begin{pmatrix} a_1 & 0 & b_1 & 0 \\ 0 & a_2 & 0 & b_2 \\ c_1 & 0 & d_1 & 0 \\ 0 & c_2 & 0 & d_2 \end{pmatrix},$$

(we exchange basis vectors 2 and 3). Then

$$N^- = \left\{ \begin{pmatrix} 1 & 0 & 0 & 0 \\ 0 & 1 & 0 & 0 \\ x & 0 & 1 & 0 \\ 0 & y & 0 & 1 \end{pmatrix}, x, y \in \mathbb{C} \right\}.$$

$A_2 = \mathfrak{sl}(3)$:

Let $g \in \mathfrak{sl}(3)$ i.e

$$g = \begin{pmatrix} a_1 & b_1 & c_1 \\ a_2 & b_2 & c_2 \\ a_3 & b_3 & c_3 \end{pmatrix} \text{ such that } a_1 + b_2 + c_3 = 0.$$

then

$$N^- = \left\{ \begin{pmatrix} 1 & 0 & 0 \\ x & 1 & 0 \\ z & y & 1 \end{pmatrix}, x, y, z \in \mathbb{C} \right\}.$$

With this parametrization, we immediately see the Plücker relation in \mathcal{PL}_{red} :

$$\boxed{3} (g) - \frac{\boxed{2}}{\boxed{3}} (g) + \frac{\boxed{1}\boxed{2}}{\boxed{3}} (g) = z - (xy - z) + yx = 0.$$

$C_2 = \mathfrak{sp}(4)$:

The natural realization of the Lie algebra $\mathfrak{sp}(4)$ is given by $X = \begin{pmatrix} A & B \\ C & -{}^tA \end{pmatrix}$ with A, B, C 2×2 matrices, and ${}^tB = B$ and ${}^tC = C$. We modify this realization by permuting the basis vectors 3 and 4 :

$$X = \begin{pmatrix} a & b & u & v \\ c & d & v & w \\ x & y & -a & -c \\ y & z & -b & -d \end{pmatrix} \mapsto \begin{pmatrix} a & b & v & u \\ c & d & w & v \\ y & z & -d & -b \\ x & y & -c & -a \end{pmatrix}.$$

Then the group N^- becomes :

$$N^- = \left\{ \begin{pmatrix} 1 & 0 & 0 & 0 \\ x & 1 & 0 & 0 \\ z & u & 1 & 0 \\ y & z - xu & -x & 1 \end{pmatrix}, \quad x, y, z, u \in \mathbb{C} \right\}.$$

G_2 :

The natural realization of the Lie algebra G_2 is given by :

$$X = \begin{pmatrix} A & V & -j(\frac{W}{\sqrt{2}}) \\ -{}^tW & 0 & -{}^tV \\ -j(\frac{V}{\sqrt{2}}) & W & -{}^tA \end{pmatrix}$$

where V, W are 3×1 column-matrices, $j(U)$ is the 3×3 matrix of the exterior product in \mathbb{C}^3 : $j(U)V = U \wedge V$ and A is a 3×3 matrix such that $tr(A) = 0$.

To imbed \mathfrak{n}^- in the space of lower triangular matrices, we effect the permutation $\begin{pmatrix} 1 & 2 & 3 & 4 & 5 & 6 & 7 \\ 7 & 2 & 1 & 4 & 5 & 6 & 3 \end{pmatrix}$ on the vector basis. Then, we obtain the Lie algebra :

$$\mathfrak{n}^- = \left\{ \begin{pmatrix} 0 & 0 & 0 & 0 & 0 & 0 & 0 \\ -x & 0 & 0 & 0 & 0 & 0 & 0 \\ y & a & 0 & 0 & 0 & 0 & 0 \\ \sqrt{2}z & \sqrt{2}y & \sqrt{2}x & 0 & 0 & 0 & 0 \\ -b & -z & 0 & -\sqrt{2}x & 0 & 0 & 0 \\ -c & 0 & z & -\sqrt{2}y & -a & 0 & 0 \\ 0 & c & b & -\sqrt{2}z & -y & x & 0 \end{pmatrix} \right\}$$

and the following corresponding group : N^- is the set of matrices :

$$\begin{pmatrix} 1 & 0 & 0 & 0 & 0 & 0 & 0 \\ x & 1 & 0 & 0 & 0 & 0 & 0 \\ y & a & 1 & 0 & 0 & 0 & 0 \\ z & -\sqrt{2}ax + \sqrt{2}y & -\sqrt{2}x & 1 & 0 & 0 & 0 \\ b & -ax^2 + xy - \frac{\sqrt{2}}{2}z & -x^2 & \sqrt{2}x & 1 & 0 & 0 \\ c & axy + \frac{\sqrt{2}}{2}az - y^2 & xy + \frac{\sqrt{2}}{2}z & -\sqrt{2}y & -a & 1 & 0 \\ -yb - xc - \frac{z^2}{2} & \frac{\sqrt{2}}{2}axz - ab - \frac{\sqrt{2}}{2}yz - c & \frac{\sqrt{2}}{2}xz - b & -z & -y + ax & -x & 1 \end{pmatrix},$$

with a, b, c, x, y, z in \mathbb{C} .

In each case, we consider first the Young tableaux with 1 column and 1 or 2 rows, corresponding to particular subrepresentations in \mathbb{C}^n ($n = 4, 3, 4, 7$) and $\wedge^2 \mathbb{C}^n$, which are isomorphic to the fundamental representations $\Gamma_{1,0}$ and $\Gamma_{0,1}$ of the Lie algebra. This selection of tableaux can be viewed as the traduction of some ‘‘internal’’ Plücker

relations for our Lie algebra.

$$\underline{A_1 \times A_1 = \mathfrak{sl}(2) \times \mathfrak{sl}(2)} :$$

The $\Gamma_{1,0}$ representation occurs in \mathbb{C}^4 , we find the basis $\boxed{1}$, $\boxed{3}$ and 2 internal Plücker relations

$$\boxed{2} = 0, \quad \boxed{4} = 0.$$

The $\Gamma_{0,1}$ representation occurs in $\wedge^2 \mathbb{C}^4$, we find the basis $\boxed{\frac{1}{2}}$, and $\boxed{\frac{1}{4}}$ and 4 internal Plücker relations

$$\boxed{\frac{2}{4}} = 0, \quad \boxed{\frac{1}{3}} = 0, \quad \boxed{\frac{2}{3}} = -\boxed{3} \quad \text{and} \quad \boxed{\frac{3}{4}} = -\boxed{\frac{1}{4} \frac{3}}.$$

Thus we get the following Young semi standard tableaux with 1 column, for $\mathfrak{sl}(2) \times \mathfrak{sl}(2)$:

$$\boxed{1}, \boxed{3}, \boxed{\frac{1}{2}}, \quad \text{and} \quad \boxed{\frac{1}{4}}.$$

$$\underline{A_2 = \mathfrak{sl}(3)} :$$

By definition, there is no internal Plücker relations for A_2 , the semi standard Young tableaux with 1 column are :

$$\boxed{1}, \boxed{2}, \boxed{3}, \boxed{\frac{1}{2}}, \boxed{\frac{1}{3}}, \quad \text{and} \quad \boxed{\frac{2}{3}}.$$

$$\underline{C_2 = \mathfrak{sp}(4)} :$$

The $\Gamma_{1,0}$ representation occurs in \mathbb{C}^4 , we find the basis $\boxed{1}$, $\boxed{2}$, $\boxed{3}$ and $\boxed{4}$.

The $\Gamma_{0,1}$ representation is the quotient of $\wedge^2 \mathbb{C}^4$ by the invariant symplectic form. Then we have 1 internal Plücker relation which is written as follows:

$$\boxed{\frac{1}{4}} - \boxed{\frac{2}{3}} = 0.$$

Thus we choose the Young semi standard tableaux with 1 column, for $\mathfrak{sp}(4)$:

$$\boxed{1}, \boxed{2}, \boxed{3}, \boxed{4}, \boxed{\frac{1}{2}}, \boxed{\frac{1}{3}}, \boxed{\frac{2}{3}}, \boxed{\frac{2}{4}}, \quad \text{and} \quad \boxed{\frac{3}{4}}.$$

This choice does coincide with the choice made in [ADLMPPrW].

$$\underline{G_2} :$$

The $\Gamma_{1,0}$ representation occurs in \mathbb{C}^7 , we find the basis $\boxed{1}$, $\boxed{2}$, $\boxed{3}$, $\boxed{4}$, $\boxed{5}$, $\boxed{6}$ and $\boxed{7}$.

The $\Gamma_{0,1}$ representation is the quotient of $\wedge^2 \mathbb{C}^7$ by a seven dimensional module. Then we have 7 internal Plücker relation which is written as follows:

$$\begin{aligned} \frac{\boxed{1}}{\boxed{4}} + \sqrt{2} \frac{\boxed{2}}{\boxed{3}} = 0, \quad \frac{\boxed{2}}{\boxed{4}} - \sqrt{2} \frac{\boxed{1}}{\boxed{5}} = 0, \quad \frac{\boxed{3}}{\boxed{4}} + \sqrt{2} \frac{\boxed{1}}{\boxed{6}} = 0, \quad \frac{\boxed{4}}{\boxed{5}} + \sqrt{2} \frac{\boxed{2}}{\boxed{7}} = 0, \\ \frac{\boxed{4}}{\boxed{6}} - \sqrt{2} \frac{\boxed{3}}{\boxed{7}} = 0, \quad \frac{\boxed{4}}{\boxed{7}} + \sqrt{2} \frac{\boxed{5}}{\boxed{6}} = 0, \quad \text{and} \quad \frac{\boxed{1}}{\boxed{7}} - \frac{\boxed{2}}{\boxed{6}} - \frac{\boxed{3}}{\boxed{5}} = 0. \end{aligned}$$

Indeed, in view of the lower triangular matrices in G_2 , with 1 on the diagonal, we find directly those relations are holding for the corresponding functions. Moreover, these relations are covariant under the action of the diagonal matrices, there are holding for the corresponding functions on the lower triangular matrices in G_2 , with any non vanishing diagonal entries, thus by N^+ invariance, they hold on G_2 .

Thus we choose the Young semi standard tableaux with 1 column, for G_2 :

$$\begin{aligned} & \boxed{1}, \boxed{2}, \boxed{3}, \boxed{4}, \boxed{5}, \boxed{6}, \boxed{7} \\ & \frac{\boxed{1}}{\boxed{2}}, \frac{\boxed{1}}{\boxed{3}}, \frac{\boxed{1}}{\boxed{4}}, \frac{\boxed{1}}{\boxed{5}}, \frac{\boxed{1}}{\boxed{6}}, \frac{\boxed{1}}{\boxed{7}}, \frac{\boxed{2}}{\boxed{5}}, \frac{\boxed{2}}{\boxed{6}}, \frac{\boxed{2}}{\boxed{7}}, \frac{\boxed{3}}{\boxed{6}}, \frac{\boxed{3}}{\boxed{7}}, \frac{\boxed{4}}{\boxed{7}}, \frac{\boxed{5}}{\boxed{7}}, \text{ and } \frac{\boxed{6}}{\boxed{7}}. \end{aligned}$$

This choice does coincide with the choice made in [ADLMPPrW].

4. SEMI STANDARD YOUNG TABLEAUX FOR THE RANK TWO SEMISIMPLE LIE ALGEBRAS

Following [ADLMPPrW], we have a construction of semi standard Young tableaux for $\Gamma_{a,b}$, for any a and b , knowing those of $\Gamma_{0,1}$ and $\Gamma_{1,0}$. In fact, by a general result of Kostant (see [FH] for instance), each non semi standard Young tableau contains a non semi standard tableau with 2 columns. Thus, it is sufficient to determine all non semi standard tableaux with 2 columns. (In fact we shall get conditions of 1 or 2 successive columns $T^{(i)}$ and $T^{(i+1)}$ in the tableau T).

We begin to look the fundamental representations $\Gamma_{0,1}$ and $\Gamma_{1,0}$ for the rank two semisimple Lie algebras as spaces generated by a succession of action of $X_{-\alpha}$ and $X_{-\beta}$ on the highest weight vector.

$A_1 \times A_1$:

The fundamental representations look like :



We associate to these drawing the two following ordered sets (respectively) :



A_2 :

The fundamental representations look like :

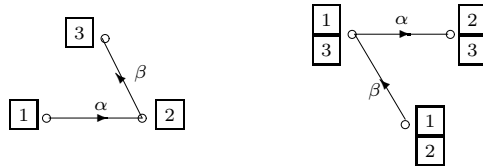

Then, we represent these drawing by the two following ordered sets (respectively):



C_2 :

The fundamental representations look like :

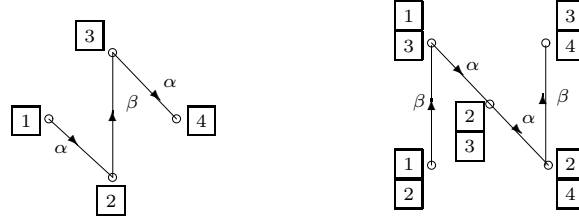

Then, We associate to these drawing the two following ordered sets (respectively) :

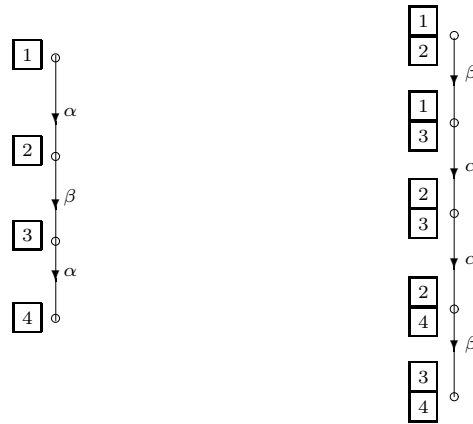

G_2 :

The fundamental representations look like :

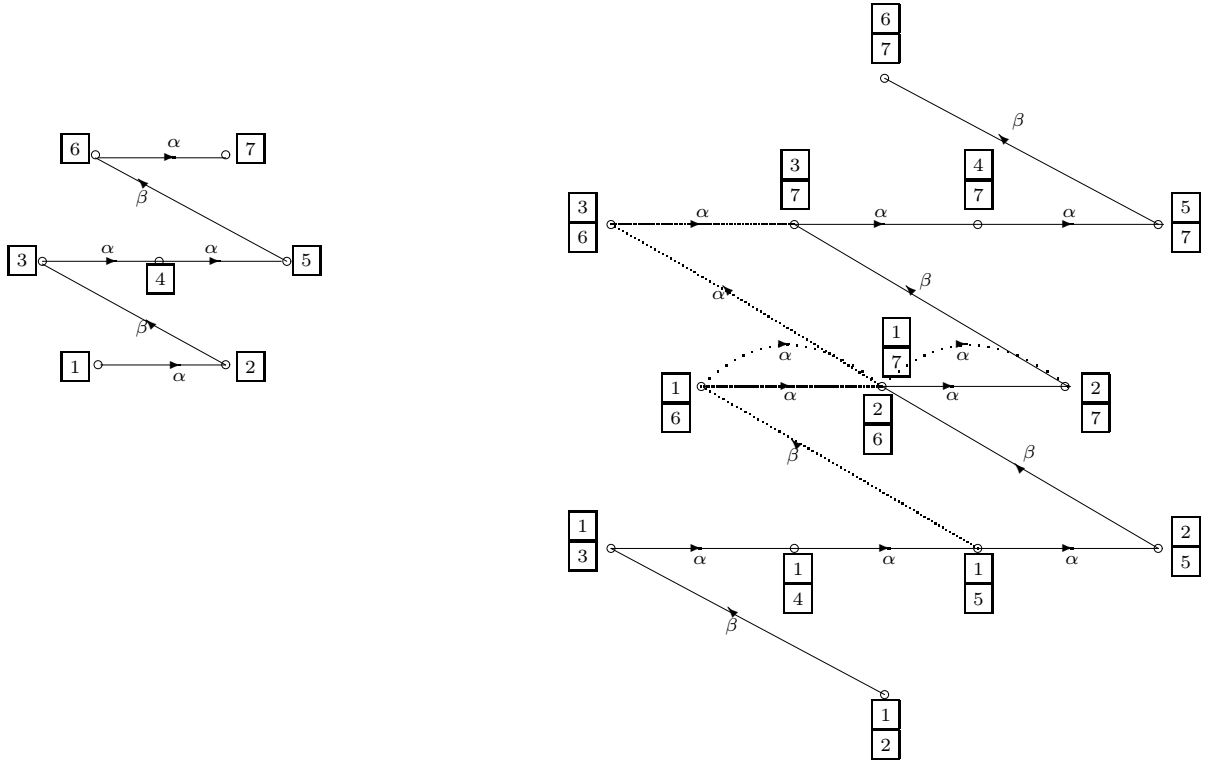

Then, we associate to these drawing the two following ordered sets (respectively) :

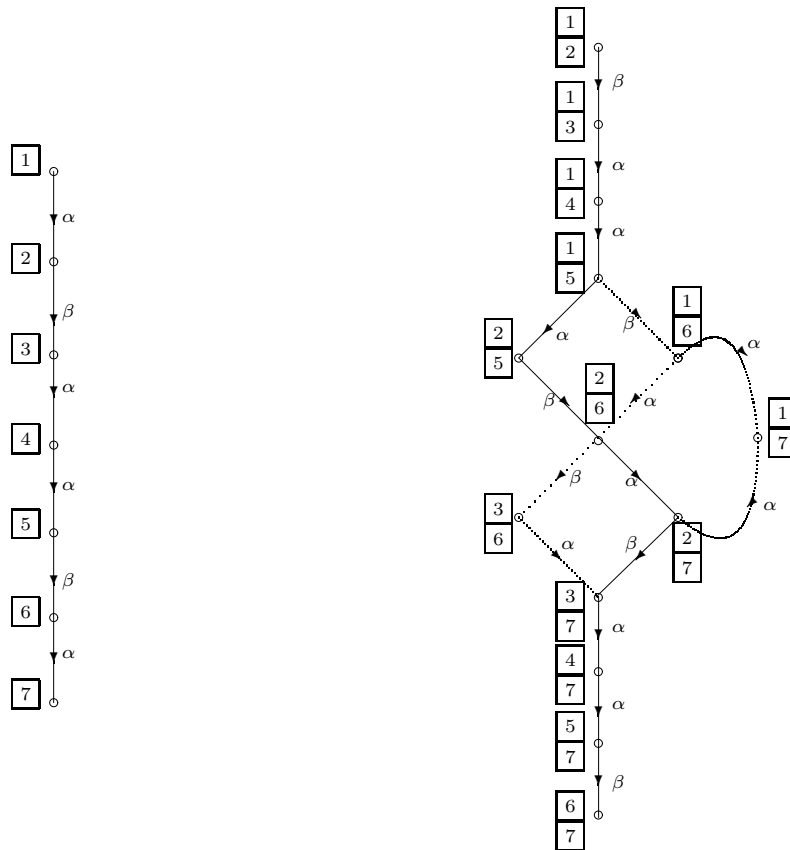

Then, we can realize these chosen paths as the family L of ideals of some partially ordered sets P (which are called **posets**). An ideal in P is a subset $I \subset P$ such that if $u \in P$ and $v \leq u$, then $v \in I$. With our choice, we take the following fundamental posets denoted $P_{1,0}$ and $P_{0,1}$ and we associate for each of them the correspondent distributive lattice of their ideals enoted $L_{1,0}$ and $L_{0,1}$ (respectively).

$A_1 \times A_1$:

$P_{1,0}$:



$P_{0,1}$:



$L_{1,0}$:

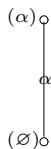

$L_{0,1}$:

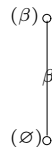

A_2 :

$P_{1,0}$:

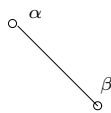

$P_{0,1}$:

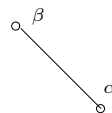

$L_{1,0}$:

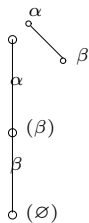

$L_{0,1}$:

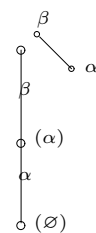

C_2 :

$P_{1,0}$:

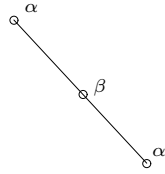

$P_{0,1}$:

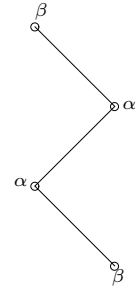

$L_{1,0}$:

$L_{0,1}$:

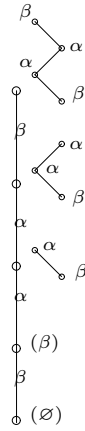
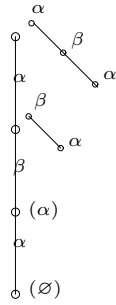

G_2 :

$P_{1,0}$:

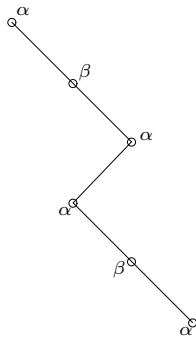

$P_{0,1}$:

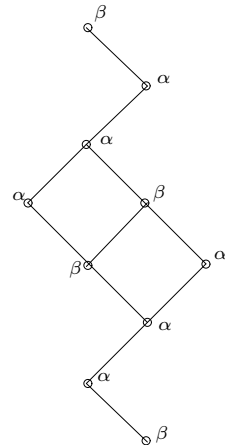

$\underline{L_{1,0}} :$

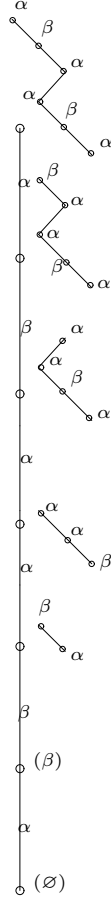

$\underline{L_{0,1}} :$

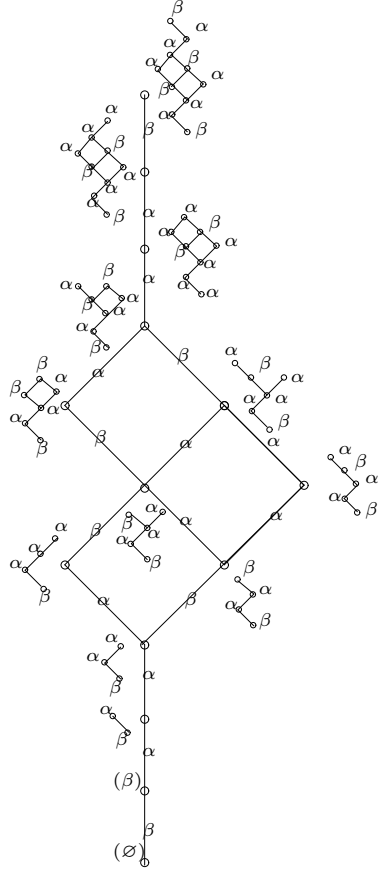

We will generalize this construction for all irreducible representations of any rank two semisimple Lie algebra. We want to define the poset $P_{a,b}$ associated to the representation $\Gamma_{a,b}$ in such a way that $L_{a,b}$ gives us the possible paths in $\Gamma_{a,b}$. We need some definitions (see [ADLMPPrW]).

Definitions 4.1.

- 1) Let (P, \leq) be a partially ordered set and $v, w \in P$ such that $v \leq w$. We define the interval $[v, w]$ as the set

$$[v, w] = \{x \in P : v \leq x \leq w\}.$$

We say that w covers v if $[v, w] = \{v, w\}$.

- 2) A two-color poset is a poset P for which we can associate for each vertex in P a color α or β . The function $v \mapsto \text{color}(v)$ is the **color** function .
- 3) We are going to select and numbered some chains in P . To do this, we define a chain function:

$$\mathbf{chain} : P \longrightarrow [[1, m]]$$

such that:

- i) for $1 \leq i \leq m$, $\text{chain}^{-1}(i)$ is a (possibly empty) chain in P .
- ii) $\forall u, v \in P$, if v covers u then either $\text{chain}(u) = \text{chain}(v)$ or $\text{chain}(u) = \text{chain}(v) + 1$.

We represent the function chain as follow:

If $\text{chain}(u) = \text{chain}(v) + 1 = k + 1$ then we draw:

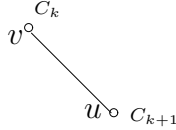

and if $\text{chain}(u) = \text{chain}(v) = k$ then we draw:

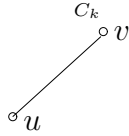

Examples 4.2.

For the C_2 case, we shall choose:

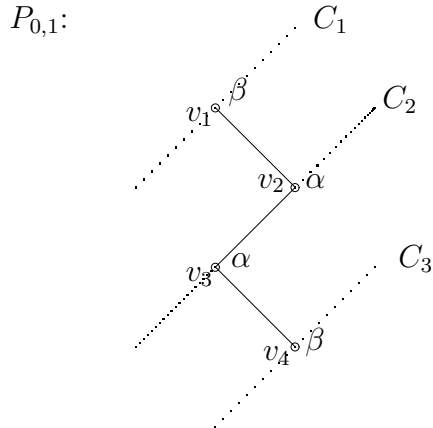

For the G_2 case, we choose:

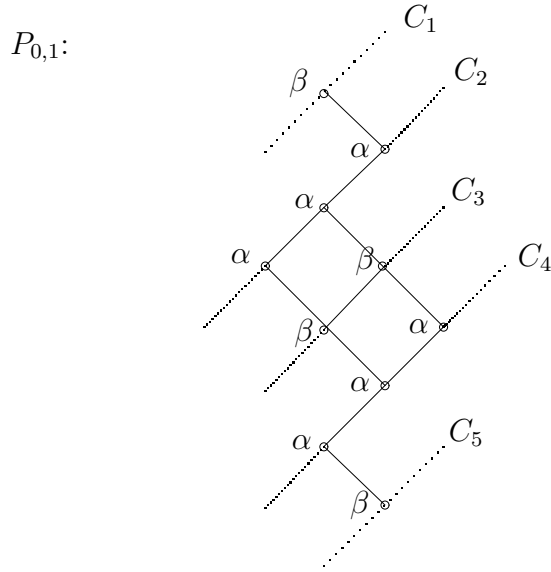

These pictures represent the fundamental posets with the function color and the function chain. They are uniquely defined with the grid property.

Definition 4.3.

A two-color grid poset is a poset (P, \leq) together with a chain function chain and a color function color such that : if u and v are two vertices in the same connected components of P and satisfying:

- i) if $chain(u) = chain(v) + 1$ then $color(u) \neq color(v)$,
- ii) if $chain(u) = chain(v)$ then $color(u) = color(v)$.

Remark 4.4.

On the fundamental posets, there is an unique chain map such that the result are the two-color grid posets. This choice corresponds to our drawing for each $P_{a,b}$ where $a + b = 1$.

Let us consider now the definition for posets $P_{a,b}$, $a + b \geq 1$.

Definition 4.5.

A **grid** is a two-color grid poset which has moreover the following max property :

- i) if u is any maximal element in the poset P , then

$$chain(u) \leq \inf_{x \in P} chain(x) + 1,$$
- ii) if $v \neq u$ is another maximal element in P , then

$$color(u) \neq color(v).$$

Remark 4.6.

The fundamental posets are grid posets.

From now on, we identify two grid posets with the same poset, the same color function and two chain maps: $chain(u)$ and $chain'(u)$, if there is k such that $chain'(u) = chain(u) + k$ for any u .

Definition 4.7. Given two grid posets P and Q , we denote by $P \triangleleft Q$ the grid poset with the following properties:

- i) The elements of $P \triangleleft Q$ is the union of elements of P and those of Q .
- ii) P is an ideal of $P \triangleleft Q$ i.e if $u \in P$ and $v \leq u$ in $P \triangleleft Q$ then $v \in P$, the functions color and chain of P are the restriction of the functions color and chain of $P \triangleleft Q$ (up to a renumbering of chains).
- iii) $(P \triangleleft Q) \setminus P$ with the restriction of functions color and chain on $P \triangleleft Q$ is isomorphic to Q (up to a renumbering of chains p).
- iv) The following holds :

if u (resp. v) is a maximal element in P (resp. in Q), then $chain(u) \leq chain(v)$,

and

if u (resp. v) is a minimal element in P (resp. in Q), then $chain(u) \leq chain(v)$.

If $P \triangleleft Q$ exists, thus $P \triangleleft Q$ is uniquely determined by these conditions, up to a renumbering of chain.

Remark 4.8.

Given three grid posets P , Q , and R then :

$$(P \triangleleft Q) \triangleleft R \simeq P \triangleleft (Q \triangleleft R).$$

We denote this $P \triangleleft Q \triangleleft R$.

Starting with the grid posets $P_{1,0}$ and $P_{0,1}$ defined for the rank two semisimple Lie algebra, for any natural numbers a and b , there exists one and only one grid poset

$$P_{a,b} = \underbrace{P_{0,1} \triangleleft \dots \triangleleft P_{0,1}}_b \triangleleft \underbrace{P_{1,0} \triangleleft \dots \triangleleft P_{1,0}}_a.$$

Now, given the grid poset $P_{a,b}$, we obtain a basis of $\Gamma_{a,b}$ by building the corresponding distributive lattice $L_{a,b}$ of ideals in $P_{a,b}$ and labelling the vertices of $L_{a,b}$ as follows:

we start with the highest weight Young tableaux of shape λ : b columns $\begin{bmatrix} 1 \\ 2 \end{bmatrix}$ and a columns $\begin{bmatrix} 1 \end{bmatrix}$. We put this tableau on the vertex of $L_{a,b}$ corresponding to the total ideal $P_{a,b}$. Now, we reach any vertex in $L_{a,b}$ by following a sequence of edges α or β . By construction, we know if this edge corresponds to a vertex in $P_{0,1}$ or in $P_{1,0}$. if the corresponding vertex is in a $P_{1,0}$ -component in $P_{a,b}$, we act with the edge on the

first possible column with size 1. And if it is in a $P_{0,1}$ -component in $P_{a,b}$, we act with the edge on the first possible column with size 2.

Now, we just draw the $L_{2,0}$, $L_{1,1}$ and $L_{0,2}$ pictures for each rank two Lie algebra and we call semi standard tableaux the obtained basis. We summarize the result here:

Proposition 4.9.

Let a, b be 2 natural numbers, and let $\lambda = (a, b)$. The set of semi standard tableaux for the Lie algebras of type 'type' with size λ is denoted $\mathcal{S}_{\text{type}}(\lambda)$. Then we get:

- $\mathcal{S}_{A_1 \times A_1}(\lambda) = \left\{ \text{usual semi standard tableaux } T \text{ of shape } \lambda \text{ with entries in } \{1, 2, 3, 4\} \right.$

$\left. \text{such that } \begin{bmatrix} 2 \\ 2 \end{bmatrix}, \begin{bmatrix} 4 \\ 4 \end{bmatrix}, \begin{bmatrix} 1 \\ 3 \end{bmatrix}, \begin{bmatrix} 2 \\ 3 \end{bmatrix}, \begin{bmatrix} 2 \\ 4 \end{bmatrix} \text{ and } \begin{bmatrix} 3 \\ 4 \end{bmatrix} \text{ are not a column of } T \right\}$.

- $\mathcal{S}_{A_2}(\lambda) = \left\{ \text{usual semi standard tableaux } T \text{ of shape } \lambda \text{ with entries in } \{1, 2, 3\} \right\}$.

- $\mathcal{S}_{C_2}(\lambda) = \left\{ \text{usual semi standard tableaux } T \text{ of shape } \lambda \text{ with entries in } \{1, 2, 3, 4\} \right.$

$\left. \text{such that } \begin{bmatrix} 1 \\ 4 \end{bmatrix} \text{ is not a column of } T \text{ and } \begin{bmatrix} 2 \\ 3 \end{bmatrix} \text{ appears at most once in } T \right\}$.

- $\mathcal{S}_{G_2}(\lambda) = \left\{ \text{usual semi standard tableaux } T \text{ of shape } \lambda \text{ with entries in } \{1, 2, 3, 4, 5, 6, 7\} \right.$

$\left. \text{such that the column } \begin{bmatrix} 4 \\ 4 \end{bmatrix} \text{ appears at most once in } T, \begin{bmatrix} 2 \\ 3 \end{bmatrix}, \begin{bmatrix} 2 \\ 4 \end{bmatrix}, \begin{bmatrix} 3 \\ 4 \end{bmatrix}, \begin{bmatrix} 3 \\ 5 \end{bmatrix}, \begin{bmatrix} 4 \\ 5 \end{bmatrix}, \begin{bmatrix} 4 \\ 6 \end{bmatrix} \right.$

$\left. \text{and } \begin{bmatrix} 5 \\ 6 \end{bmatrix} \text{ are not a column in } T \text{ plus the restriction given by the following table} \right\}$.

Column $T^{(i)}$ of T	Then the succeeding column $T^{(i+1)}$ of T cannot be...
$\begin{array}{ c } \hline 4 \\ \hline \end{array}$	$\begin{array}{ c } \hline 4 \\ \hline \end{array}$
$\begin{array}{ c } \hline 1 \\ \hline 4 \\ \hline \end{array}$	$\begin{array}{ c } \hline 1 \\ \hline 4 \\ \hline \end{array}, \begin{array}{ c } \hline 1 \\ \hline 5 \\ \hline \end{array}, \begin{array}{ c } \hline 1 \\ \hline 6 \\ \hline \end{array}, \begin{array}{ c } \hline 1 \\ \hline 7 \\ \hline \end{array}$
$\begin{array}{ c } \hline 1 \\ \hline 5 \\ \hline \end{array}$	$\begin{array}{ c } \hline 1 \\ \hline 5 \\ \hline \end{array}, \begin{array}{ c } \hline 1 \\ \hline 6 \\ \hline \end{array}, \begin{array}{ c } \hline 1 \\ \hline 7 \\ \hline \end{array}$
$\begin{array}{ c } \hline 1 \\ \hline 6 \\ \hline \end{array}$	$\begin{array}{ c } \hline 1 \\ \hline 6 \\ \hline \end{array}, \begin{array}{ c } \hline 2 \\ \hline 6 \\ \hline \end{array}, \begin{array}{ c } \hline 1 \\ \hline 7 \\ \hline \end{array}, \begin{array}{ c } \hline 2 \\ \hline 7 \\ \hline \end{array}$
$\begin{array}{ c } \hline 2 \\ \hline 6 \\ \hline \end{array}$	$\begin{array}{ c } \hline 2 \\ \hline 6 \\ \hline \end{array}, \begin{array}{ c } \hline 2 \\ \hline 7 \\ \hline \end{array}$
$\begin{array}{ c } \hline 1 \\ \hline 7 \\ \hline \end{array}$	$\begin{array}{ c } \hline 1 \\ \hline 7 \\ \hline \end{array}, \begin{array}{ c } \hline 2 \\ \hline 7 \\ \hline \end{array}, \begin{array}{ c } \hline 3 \\ \hline 7 \\ \hline \end{array}, \begin{array}{ c } \hline 4 \\ \hline 7 \\ \hline \end{array}$
$\begin{array}{ c } \hline 2 \\ \hline 7 \\ \hline \end{array}$	$\begin{array}{ c } \hline 2 \\ \hline 7 \\ \hline \end{array}, \begin{array}{ c } \hline 3 \\ \hline 7 \\ \hline \end{array}, \begin{array}{ c } \hline 4 \\ \hline 7 \\ \hline \end{array}$
$\begin{array}{ c } \hline 3 \\ \hline 7 \\ \hline \end{array}$	$\begin{array}{ c } \hline 3 \\ \hline 7 \\ \hline \end{array}, \begin{array}{ c } \hline 4 \\ \hline 7 \\ \hline \end{array}$
$\begin{array}{ c } \hline 4 \\ \hline 7 \\ \hline \end{array}$	$\begin{array}{ c } \hline 4 \\ \hline 7 \\ \hline \end{array}$

5. SHAPE AND REDUCED SHAPE ALGEBRAS

In section 2, We realize \mathfrak{g} as a space of $n \times n$ matrices ($n = 4, 3, 4, 7$), we consider the subgroup HN^- of matrices in G which are lower triangular, we look for polynomial functions in the entries of these matrices, the space of these functions is $\mathbb{C}[HN^-]$. We get:

For $A_1 \times A_1$:

$$g \in HN^- \text{ means } g = \begin{pmatrix} h_1 & 0 & 0 & 0 \\ 0 & h_2 & 0 & 0 \\ x & 0 & h_1^{-1} & 0 \\ 0 & y & 0 & h_2^{-1} \end{pmatrix} \text{ and } \mathbb{C}[HN^-] = \mathbb{C}[h_1, h_2, x, y],$$

For A_2 :

$$g \in HN^- \text{ means } g = \begin{pmatrix} h_1 & 0 & 0 \\ x & h_1^{-1}h_2 & 0 \\ z & y & h_2^{-1} \end{pmatrix} \text{ and } \mathbb{C}[HN^-] = \mathbb{C}[h_1, h_2, x, y, z],$$

For C_2 :

$$g \in HN^- \text{ means } g = \begin{pmatrix} h_1 & 0 & 0 & 0 \\ x & h_2 & 0 & 0 \\ z & u & h_2^{-1} & 0 \\ y & z & -x & h_1^{-1} \end{pmatrix} \text{ and } \mathbb{C}[HN^-] = \mathbb{C}[h_1, h_2, x, y, z, u],$$

For G_2 :

$$g \in HN^- \text{ means } g = \begin{pmatrix} h_1 & 0 & 0 & 0 & 0 & 0 & 0 \\ x & h_1^{-1}h_2 & 0 & 0 & 0 & 0 & 0 \\ y & a & h_2^{-1} & 0 & 0 & 0 & 0 \\ z & -\sqrt{2}ax + \sqrt{2}y & -\sqrt{2}x & 1 & 0 & 0 & 0 \\ b & -ax^2 + xy - \frac{\sqrt{2}}{2}z & -x^2 & \sqrt{2}x & h_1^{-1} & 0 & 0 \\ c & axy + \frac{\sqrt{2}}{2}az - y^2 & xy + \frac{\sqrt{2}}{2}z & -\sqrt{2}y & -a & h_1h_2^{-1} & 0 \\ -yb - xc - \frac{z^2}{2} & \frac{\sqrt{2}}{2}axz - ab - \frac{\sqrt{2}}{2}yz - c & \frac{\sqrt{2}}{2}xz - b & -z & -y + ax & -x & h_2 \end{pmatrix}$$

and $\mathbb{C}[HN^-] = \mathbb{C}[h_1, h_2, a, b, c, x, y, z]$.

As in the $SL(n)$ case, we can consider these polynomial functions as polynomial functions on the group G which are invariant under multiplication on the right side by N^+ . Thus, we get:

$$\mathbb{C}[HN^-] \simeq \mathbb{C}[G]^{N^+}$$

and the semi standard Young tableaux give a basis for $\mathbb{C}[HN^-]$.

Definition 5.1.

The **shape algebra** \mathbb{S}_G of G is by definition the vector space $\mathbb{S}_G = \bigoplus_{a,b} \Gamma_{a,b}$ equipped with the multiplication defined by the transposition of the natural maps:

$$\Gamma_{a+a', b+b'} \hookrightarrow \Gamma_{a,b} \otimes \Gamma_{a',b'}.$$

Then by construction, the set of semi standard tableaux forms a basis of the shape algebra and we get :

$$\mathbb{C}[G]^{N^+} \simeq \mathbb{S}_G \simeq \text{Sym}^\bullet(\mathbb{C} \wedge^2 / \mathcal{PL})$$

where \mathcal{PL} is the ideal generated by all the Plücker relations (internal or not). From now on, we consider the restriction of the functions in \mathbb{S}_G to the subgroup N^- . We get a quotient of \mathbb{S}_G which is, as a vector space, the space $\mathbb{C}[N^-]$.

The quotient has the form

$$\mathbb{C}[HN^-] / \langle \begin{bmatrix} 1 \\ 2 \end{bmatrix} - 1, \begin{bmatrix} 1 \end{bmatrix} - 1 \rangle \simeq \mathbb{C}[N^-].$$

Since the ideal is N^+ invariant, we get a structure of N^+ module on this space $\mathbb{C}[N^-]$. This structure is defined by:

$$(n^+.f)(n_1^-) = f({}^t n^+ n_1^-).$$

Definition 5.2.

We call **reduced shape algebra** and denote \mathbb{S}_G^{red} this quotient module, as a vector space, $\mathbb{S}_G^{red} \simeq \mathbb{C}[N^-]$.

Starting with the lowest weight vector in any $\Gamma_{a,b} \subset \mathbb{C}[HN^-]$, which is the Young tableau

$$\begin{array}{|c|c|c|c|c|c|} \hline n-1 & \cdots & n-1 & n & \cdots & n \\ \hline n & \cdots & n & & & \\ \hline \end{array},$$

acting with N^+ , we generate exactly $\Gamma_{a,b}$ thus the canonical mapping

$$\pi : \mathbb{S}_G \longrightarrow \mathbb{S}_G^{red}$$

induces a bijective map from $\Gamma_{a,b}$ onto $\pi(\Gamma_{a,b})$.

Now, since the heighest weight vector $\begin{array}{|c|c|c|c|c|c|} \hline 1 & \cdots & 1 & 1 & \cdots & 1 \\ \hline 2 & \cdots & 2 & & & \\ \hline \end{array}$ is the constant function 1 in \mathbb{S}_G^{red} , the N^+ module \mathbb{S}_G^{red} is indecomposable and $\pi(\Gamma_{a',b'}) \subset \pi(\Gamma_{a,b})$ if $a' \leq a$ and $b' \leq b$.

Thus we have:

$$\mathbb{S}_G^{red} = \bigcup_{a,b} \pi(\Gamma_{a,b})$$

and

$$\pi(\Gamma_{a,b}) = \bigcup_{\substack{a' \leq a \\ b' \leq b}} \pi(\Gamma_{a',b'}).$$

We look for a basis for \mathbb{S}_G^{red} which will be well adapted to this "decomposition" of $\mathbb{C}[N^-] = \mathbb{S}_G^{red}$.

6. QUASI STANDARD YOUNG TABLEAUX

Let us give now the definition of quasi standard Young tableaux, generalizing the $\mathfrak{sl}(3)$ case construction. The set of quasi standard tableaux for the Lie algebras of type 'type' with size λ is denoted $\mathcal{QS}_{type}(\lambda)$. We use a case-by-case argument.

First case : $A_1 \times A_1$:

There is no ‘external’ Plücker relation in this case, thus we just suppress the trivial column $\begin{bmatrix} 1 \\ 2 \end{bmatrix}$ and $\begin{bmatrix} 1 \end{bmatrix}$ in the semi standard Young tableaux for $A_1 \times A_1$. Thus we get :

$$\mathcal{QS}_{A_1 \times A_1}(\lambda) = \{T \in \mathcal{S}_{A_1 \times A_1}(\lambda), T \text{ without any trivial column}\},$$

and the picture

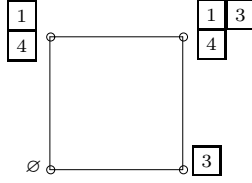

Second case : A_2 :

This case is completely described in section1.

Third case : C_2 :

Let T be a semi standard tableau for C_2 . If T does not contain the column $\begin{bmatrix} 2 \\ 3 \end{bmatrix}$, we say that T is quasi standard if and only if it is quasi standard for $\mathfrak{sl}(4)$. If T contains the column $\begin{bmatrix} 2 \\ 3 \end{bmatrix}$, we replace it by the column $\begin{bmatrix} 1 \\ 4 \end{bmatrix}$, getting a new tableau T' . T' is still semi standard for $\mathfrak{sl}(4)$.

We say that T is quasi standard if and only if T' is quasi standard for $\mathfrak{sl}(4)$.

Example 6.1.

For $\lambda = (2, 1)$, we get the following family of quasi standard tableaux with shape λ :

$$\mathcal{QS}_{C_2}(2, 1) = \left\{ \begin{array}{l} \begin{bmatrix} 1 & 3 & 3 \\ 3 \end{bmatrix}, \begin{bmatrix} 1 & 3 & 4 \\ 3 \end{bmatrix}, \begin{bmatrix} 1 & 4 & 4 \\ 3 \end{bmatrix}, \begin{bmatrix} 2 & 4 & 4 \\ 3 \end{bmatrix}, \begin{bmatrix} 2 & 2 & 2 \\ 4 \end{bmatrix}, \begin{bmatrix} 2 & 2 & 3 \\ 4 \end{bmatrix}, \\ \begin{bmatrix} 2 & 3 & 3 \\ 4 \end{bmatrix}, \begin{bmatrix} 2 & 2 & 4 \\ 4 \end{bmatrix}, \begin{bmatrix} 2 & 3 & 4 \\ 4 \end{bmatrix}, \begin{bmatrix} 2 & 4 & 4 \\ 4 \end{bmatrix}, \begin{bmatrix} 3 & 3 & 3 \\ 4 \end{bmatrix}, \begin{bmatrix} 3 & 3 & 4 \\ 4 \end{bmatrix}, \\ \begin{bmatrix} 3 & 4 & 4 \\ 4 \end{bmatrix} \end{array} \right\}.$$

Theorem 6.2.

For any $\lambda = (a, b)$, a basis for $\pi(\Gamma_{a,b})$ is parametrized by the disjoint union

$$\bigsqcup_{\substack{a' \leq a \\ b' \leq b}} \mathcal{QS}_{C_2}(a', b').$$

Then, the family of quasi standard Young tableaux forms a basis for the reduced shape algebra $\mathbb{S}_{C_2}^{red}$.

Proof :

We consider $\mathbb{S}_{C_2}^{red}$ as the quotient of the polynomial algebra in the variables:

$$X = \begin{array}{|c|} \hline 2 \\ \hline \end{array}, Y = \begin{array}{|c|} \hline 3 \\ \hline \end{array}, Z = \begin{array}{|c|} \hline 4 \\ \hline \end{array}, U = \begin{array}{|c|} \hline 1 \\ \hline 3 \\ \hline \end{array}, V = \begin{array}{|c|} \hline 2 \\ \hline 4 \\ \hline \end{array}, W = \begin{array}{|c|} \hline 2 \\ \hline 3 \\ \hline \end{array} \text{ and } T = \begin{array}{|c|} \hline 3 \\ \hline 4 \\ \hline \end{array}.$$

By the reduced Plücker relations : the ideal \mathcal{PL}_{red} generated by the relations:

$$V - XZ + X^2U + Y, T - Z^2 + ZXU + YU \text{ and } W + XU - Z.$$

Using the monomial ordering given by the lexicographic ordering on (X, Z, Y, W, V, U, T) , we get the following Groebner basis for \mathcal{PL}_{red} :

Groebner basis of \mathcal{PL}_{red} :

$$\left\{ W^2 + UV - T, WT + WYU + ZUV - ZT, -T - YU + ZW, -WY + XT - ZV, \right. \\ \left. W + XU - Z, -V - Y + XW \right\}$$

The leading monomials of these elements, with respect to our ordering are:

$$W^2, ZUV, ZW, XT, XU, XW.$$

Thus a basis for the quotient \mathbb{S}_G^{red} is given by the Young tableaux without any trivial column and which do not contain the following subtableaux:

$$\begin{array}{|c|c|} \hline 2 & 2 \\ \hline 3 & 3 \\ \hline \end{array}, \begin{array}{|c|c|c|} \hline 1 & 2 & 3 \\ \hline 3 & 4 & \\ \hline \end{array}, \begin{array}{|c|c|} \hline 2 & 3 \\ \hline 3 & \\ \hline \end{array}, \begin{array}{|c|c|} \hline 3 & 2 \\ \hline 4 & \\ \hline \end{array}, \begin{array}{|c|c|} \hline 1 & 2 \\ \hline 3 & \\ \hline \end{array}, \begin{array}{|c|c|} \hline 2 & 2 \\ \hline 3 & \\ \hline \end{array}.$$

The remaining Young tableaux are exactly the quasi standard Young tableaux.

Indeed, “ T is semi standard without any trivial column” is equivalent to “ T does not contain any trival column and does not contain $\begin{array}{|c|c|} \hline 2 & 2 \\ \hline 3 & 3 \\ \hline \end{array}$ nor $\begin{array}{|c|c|} \hline 3 & 2 \\ \hline 4 & \\ \hline \end{array}$ ”.

Moreover the remaining tableaux i.e $\begin{array}{|c|c|c|} \hline 1 & 2 & 3 \\ \hline 3 & 4 & \\ \hline \end{array}$, $\begin{array}{|c|c|} \hline 2 & 3 \\ \hline 3 & \\ \hline \end{array}$, $\begin{array}{|c|c|} \hline 1 & 2 \\ \hline 3 & \\ \hline \end{array}$, and $\begin{array}{|c|c|} \hline 2 & 2 \\ \hline 3 & \\ \hline \end{array}$ are by definition non quasi standards. Now, if T is a semi standard non quasi standard tableau, without any trivial column, T contains a minimal semi standard non quasi standard tableau without trivial column. Looking at all the possibilities for such minimal tableau with 2 columns, we get

$$\begin{array}{|c|c|} \hline 1 & 2 \\ \hline 3 & \\ \hline \end{array}, \begin{array}{|c|c|} \hline 2 & 2 \\ \hline 3 & \\ \hline \end{array} \text{ and } \begin{array}{|c|c|} \hline 2 & 3 \\ \hline 3 & \\ \hline \end{array}.$$

But there is also such minimal tableau with three columns. By minimality, such tableau has two columns of size 2 and one column of size 1, T being non quasi standard, the first column of T is $\begin{bmatrix} 1 \\ 3 \end{bmatrix}$ or $\begin{bmatrix} 2 \\ 3 \end{bmatrix}$.

If it is $\begin{bmatrix} 2 \\ 3 \end{bmatrix}$ then we get the non quasi standard tableaux :

$$\begin{bmatrix} 2 & 2 & u \\ 3 & 4 & \end{bmatrix}, \text{ and } \begin{bmatrix} 2 & 3 & v \\ 3 & 4 & \end{bmatrix} \text{ with } u \geq 2 \text{ or } v \geq 3.$$

These non quasi standard tableaux are not minimal. Thus the first column of T is $\begin{bmatrix} 1 \\ 3 \end{bmatrix}$ and T is

$$\begin{bmatrix} 1 & 2 & u \\ 3 & 4 & \end{bmatrix} \text{ or } \begin{bmatrix} 1 & 3 & v \\ 3 & 4 & \end{bmatrix}.$$

The tableau $\begin{bmatrix} 1 & 3 & v \\ 3 & 4 & \end{bmatrix}$ are quasi standard for any v . The tableau $\begin{bmatrix} 1 & 2 & 2 \\ 3 & 4 & \end{bmatrix}$ is non quasi standard non minimal, the tableau $\begin{bmatrix} 1 & 2 & 3 \\ 3 & 4 & \end{bmatrix}$ is non quasi standard minimal, the tableau $\begin{bmatrix} 1 & 2 & 3 \\ 3 & 4 & \end{bmatrix}$ is quasi standard.

The same type of argument shows that any non quasi standard Young tableaux with more than three columns is not minimal.

Finally, if T is any semi standard Young tableau containing a non quasi standard tableau, T is itself non quasi standard.

This proves that the monomial basis for the quotient coincides with the set of our quasi standard Young tableaux.

□

Here is the drawing for a part of the diamond cone of $\mathfrak{sp}(4)$

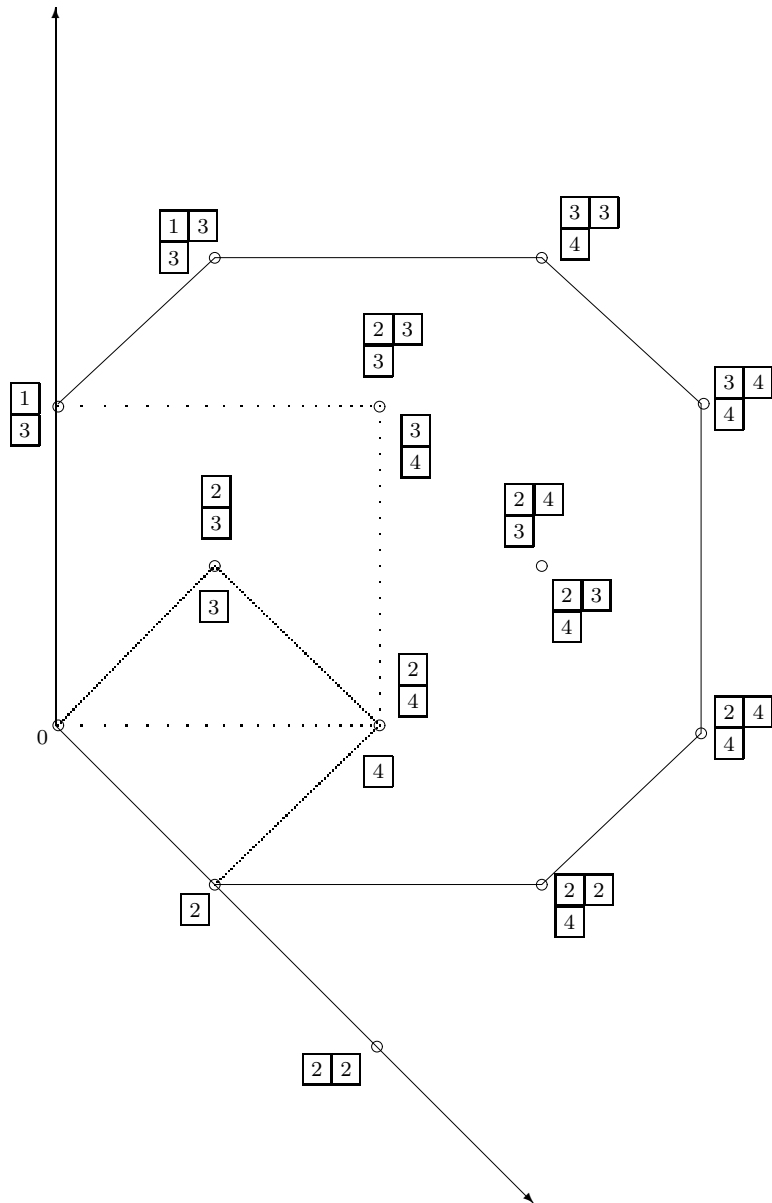

Fourth case : G_2 :

Definition 6.3. Let $T = \begin{array}{|c|c|c|c|c|} \hline a_1 & \cdots & a_p & a_{p+1} & \cdots & a_{p+q} \\ \hline b_1 & \cdots & b_p & & & \\ \hline \end{array}$ be a semi standard Young tableau of shape $\lambda = (p, q)$ for G_2 . We say that T is quasi standard if:

$$\left\{ \begin{array}{l} \begin{array}{|c|} \hline a_1 \\ \hline a_2 \\ \hline \end{array} \neq \begin{array}{|c|} \hline 1 \\ \hline 2 \\ \hline \end{array} \\ \text{and} \\ a_1 > 1 \text{ or there is } i = 1, \dots, p \text{ such that } a_{i+1} > b_i \text{ or } a_{i+1} = b_i \neq 4. \end{array} \right.$$

Let us denote by $\mathcal{QS}_{G_2}(p, q)$ the set of quasi standard tableaux with shape (p, q) , by $\mathcal{SNQS}_{G_2}(p, q)$ the set of semi standard non quasi standard tableaux with shape (p, q) . We first compute the cardinality of $\mathcal{QS}_{G_2}(p, q)$.

Let us define two operation on $T \in \mathcal{SNQS}_{G_2}(p, q)$.

a) The '**push**' operation:

Let us denote $T = \begin{array}{|c|c|c|c|c|} \hline a_1 & \cdots & a_p & a_{p+1} & \cdots & a_{p+q} \\ \hline b_1 & \cdots & b_p & & & \\ \hline \end{array} \in \mathcal{SNQS}_{G_2}(p, q)$.

• If $\begin{array}{|c|} \hline a_1 \\ \hline a_2 \\ \hline \end{array} = \begin{array}{|c|} \hline 1 \\ \hline 2 \\ \hline \end{array}$, we put

$$P(T) = \begin{array}{|c|c|c|c|c|} \hline a_2 & \cdots & a_p & a_{p+1} & \cdots & a_{p+q} \\ \hline b_2 & \cdots & b_p & & & \\ \hline \end{array}$$

• If $a_1 = 1$ or for any $i = 1, \dots, p$ such that $a_{i+1} < b_i$ or $a_{i+1} = b_i = 4$, we put

$$P(T) = \begin{array}{|c|c|c|c|c|} \hline a_2 & \cdots & a_{p+1} & a_{p+2} & \cdots & a_{p+q} \\ \hline b_1 & \cdots & b_p & & & \\ \hline \end{array} .$$

b) The '**rectification**' operation:

The tableau $P(T)$ is generally non semi standard. We define the rectification $R(P(T))$ of $P(T)$ as follows:

we read each 2 column of $P(T)$ and we replace any wrong 2 column by a corresponding acceptable one, following the table 1 :

Wrong column	acceptable column
$\begin{array}{ c } \hline 4 \\ \hline 4 \\ \hline \end{array}$	$\begin{array}{ c } \hline 1 \\ \hline 7 \\ \hline \end{array}$
$\begin{array}{ c } \hline 2 \\ \hline 3 \\ \hline \end{array}$	$\begin{array}{ c } \hline 1 \\ \hline 4 \\ \hline \end{array}$
$\begin{array}{ c } \hline 4 \\ \hline 6 \\ \hline \end{array}$	$\begin{array}{ c } \hline 3 \\ \hline 7 \\ \hline \end{array}$
$\begin{array}{ c } \hline 3 \\ \hline 5 \\ \hline \end{array}$	$\begin{array}{ c } \hline 2 \\ \hline 6 \\ \hline \end{array}$
$\begin{array}{ c } \hline 3 \\ \hline 4 \\ \hline \end{array}$	$\begin{array}{ c } \hline 1 \\ \hline 6 \\ \hline \end{array}$
$\begin{array}{ c } \hline 5 \\ \hline 6 \\ \hline \end{array}$	$\begin{array}{ c } \hline 4 \\ \hline 7 \\ \hline \end{array}$
$\begin{array}{ c } \hline 2 \\ \hline 4 \\ \hline \end{array}$	$\begin{array}{ c } \hline 1 \\ \hline 5 \\ \hline \end{array}$
$\begin{array}{ c } \hline 4 \\ \hline 5 \\ \hline \end{array}$	$\begin{array}{ c } \hline 3 \\ \hline 6 \\ \hline \end{array}$

Proposition 6.4.

For any $T \in \mathcal{SNQS}_{G_2}(p, q)$, $R(P(T))$ belongs to $\mathcal{S}_{G_2}(p-1, q) \sqcup \mathcal{S}_{G_2}(p, q-1)$.

Proof:

If $\begin{array}{|c|} \hline a_1 \\ \hline a_2 \\ \hline \end{array} = \begin{array}{|c|} \hline 1 \\ \hline 2 \\ \hline \end{array}$, this is evident. For the second case, using a computer, we consider case by case, all the possibilities for 3 successive columns in T and the corresponding result in $P(T)$. We have to consider 3 cases:

$$\begin{aligned}
 & \bullet \begin{array}{|cccc|} \hline \dots & a_i & a_{i+1} & a_{i+2} & \dots \\ \hline \dots & b_i & b_{i+1} & b_{i+2} & \dots \\ \hline \end{array} \xrightarrow{P} \begin{array}{|ccc|} \hline \dots & a_{i+1} & a_{i+2} & \dots \\ \hline \dots & b_i & b_{i+1} & \dots \\ \hline \end{array} \xrightarrow{R} \begin{array}{|ccc|} \hline \dots & a'_{i+1} & a'_{i+2} & \dots \\ \hline \dots & b'_i & b'_{i+1} & \dots \\ \hline \end{array} \\
 & \bullet \begin{array}{|ccc|} \hline \dots & a_i & a_{i+1} & a_{i+2} & \dots \\ \hline \dots & b_i & b_{i+1} & & \dots \\ \hline \end{array} \xrightarrow{P} \begin{array}{|ccc|} \hline \dots & a_{i+1} & a_{i+2} & \dots \\ \hline \dots & b_i & b_{i+1} & \\ \hline \end{array} \xrightarrow{R} \begin{array}{|ccc|} \hline \dots & a'_{i+1} & a'_{i+2} & \dots \\ \hline \dots & b'_i & b'_{i+1} & \\ \hline \end{array} \\
 & \bullet \begin{array}{|ccc|} \hline \dots & a_i & a_{i+1} & a_{i+2} & \dots \\ \hline \dots & b_i & & & \dots \\ \hline \end{array} \xrightarrow{P} \begin{array}{|ccc|} \hline \dots & a_{i+1} & a_{i+2} & \dots \\ \hline \dots & b_i & & \\ \hline \end{array} \xrightarrow{R} \begin{array}{|ccc|} \hline \dots & a'_{i+1} & a'_{i+2} & \dots \\ \hline \dots & b'_i & & \\ \hline \end{array}
 \end{aligned}$$

We verify, in each case, that the result is : $R(P(T)) \subset \mathcal{S}_{G_2}(p, q-1)$.

Indeed, for example in the third case, all tableaux T in $\mathcal{S}_{G_2}(1, 2)$ such that $a_2 < b_1$ define the following tableaux $R(P(T))$:

$$\left(\begin{array}{cccccccccccc} \begin{array}{|c|c|} \hline 1 & 2 \\ \hline 3 & \\ \hline \end{array}, & \begin{array}{|c|c|} \hline 1 & 1 \\ \hline 3 & \\ \hline \end{array}, & \begin{array}{|c|c|} \hline 1 & 2 \\ \hline 4 & \\ \hline \end{array}, & \begin{array}{|c|c|} \hline 1 & 3 \\ \hline 3 & \\ \hline \end{array}, & \begin{array}{|c|c|} \hline 1 & 3 \\ \hline 4 & \\ \hline \end{array}, & \begin{array}{|c|c|} \hline 1 & 4 \\ \hline 3 & \\ \hline \end{array}, & \begin{array}{|c|c|} \hline 1 & 4 \\ \hline 4 & \\ \hline \end{array}, & \begin{array}{|c|c|} \hline 1 & 5 \\ \hline 3 & \\ \hline \end{array}, & \begin{array}{|c|c|} \hline 1 & 5 \\ \hline 4 & \\ \hline \end{array}, & \begin{array}{|c|c|} \hline 1 & 6 \\ \hline 3 & \\ \hline \end{array}, & \begin{array}{|c|c|} \hline 1 & 6 \\ \hline 4 & \\ \hline \end{array}, \\ \begin{array}{|c|c|} \hline 1 & 7 \\ \hline 3 & \\ \hline \end{array}, & \begin{array}{|c|c|} \hline 1 & 7 \\ \hline 4 & \\ \hline \end{array}, & \begin{array}{|c|c|} \hline 1 & 2 \\ \hline 5 & \\ \hline \end{array}, & \begin{array}{|c|c|} \hline 1 & 3 \\ \hline 5 & \\ \hline \end{array}, & \begin{array}{|c|c|} \hline 1 & 3 \\ \hline 6 & \\ \hline \end{array}, & \begin{array}{|c|c|} \hline 1 & 4 \\ \hline 5 & \\ \hline \end{array}, & \begin{array}{|c|c|} \hline 1 & 4 \\ \hline 6 & \\ \hline \end{array}, & \begin{array}{|c|c|} \hline 1 & 5 \\ \hline 5 & \\ \hline \end{array}, & \begin{array}{|c|c|} \hline 1 & 5 \\ \hline 6 & \\ \hline \end{array}, & \begin{array}{|c|c|} \hline 1 & 6 \\ \hline 5 & \\ \hline \end{array}, & \begin{array}{|c|c|} \hline 1 & 6 \\ \hline 6 & \\ \hline \end{array}, \\ \begin{array}{|c|c|} \hline 1 & 7 \\ \hline 5 & \\ \hline \end{array}, & \begin{array}{|c|c|} \hline 1 & 7 \\ \hline 6 & \\ \hline \end{array}, & \begin{array}{|c|c|} \hline 2 & 2 \\ \hline 5 & \\ \hline \end{array}, & \begin{array}{|c|c|} \hline 2 & 3 \\ \hline 5 & \\ \hline \end{array}, & \begin{array}{|c|c|} \hline 2 & 3 \\ \hline 6 & \\ \hline \end{array}, & \begin{array}{|c|c|} \hline 2 & 4 \\ \hline 5 & \\ \hline \end{array}, & \begin{array}{|c|c|} \hline 2 & 4 \\ \hline 6 & \\ \hline \end{array}, & \begin{array}{|c|c|} \hline 2 & 5 \\ \hline 5 & \\ \hline \end{array}, & \begin{array}{|c|c|} \hline 2 & 5 \\ \hline 6 & \\ \hline \end{array}, & \begin{array}{|c|c|} \hline 2 & 5 \\ \hline 7 & \\ \hline \end{array}, & \begin{array}{|c|c|} \hline 2 & 6 \\ \hline 5 & \\ \hline \end{array}, \\ \begin{array}{|c|c|} \hline 2 & 6 \\ \hline 6 & \\ \hline \end{array}, & \begin{array}{|c|c|} \hline 2 & 6 \\ \hline 7 & \\ \hline \end{array}, & \begin{array}{|c|c|} \hline 2 & 7 \\ \hline 5 & \\ \hline \end{array}, & \begin{array}{|c|c|} \hline 2 & 7 \\ \hline 6 & \\ \hline \end{array}, & \begin{array}{|c|c|} \hline 2 & 7 \\ \hline 7 & \\ \hline \end{array}, & \begin{array}{|c|c|} \hline 3 & 3 \\ \hline 6 & \\ \hline \end{array}, & \begin{array}{|c|c|} \hline 3 & 4 \\ \hline 6 & \\ \hline \end{array}, & \begin{array}{|c|c|} \hline 3 & 5 \\ \hline 6 & \\ \hline \end{array}, & \begin{array}{|c|c|} \hline 3 & 5 \\ \hline 7 & \\ \hline \end{array}, & \begin{array}{|c|c|} \hline 4 & 5 \\ \hline 7 & \\ \hline \end{array}, & \begin{array}{|c|c|} \hline 3 & 6 \\ \hline 6 & \\ \hline \end{array}, \\ \begin{array}{|c|c|} \hline 3 & 6 \\ \hline 7 & \\ \hline \end{array}, & \begin{array}{|c|c|} \hline 4 & 6 \\ \hline 7 & \\ \hline \end{array}, & \begin{array}{|c|c|} \hline 3 & 7 \\ \hline 6 & \\ \hline \end{array}, & \begin{array}{|c|c|} \hline 3 & 7 \\ \hline 7 & \\ \hline \end{array}, & \begin{array}{|c|c|} \hline 4 & 7 \\ \hline 7 & \\ \hline \end{array}, & \begin{array}{|c|c|} \hline 5 & 5 \\ \hline 7 & \\ \hline \end{array}, & \begin{array}{|c|c|} \hline 5 & 6 \\ \hline 7 & \\ \hline \end{array}, & \begin{array}{|c|c|} \hline 6 & 6 \\ \hline 7 & \\ \hline \end{array}, & \begin{array}{|c|c|} \hline 5 & 7 \\ \hline 7 & \\ \hline \end{array}, & \begin{array}{|c|c|} \hline 6 & 7 \\ \hline 7 & \\ \hline \end{array}, & \begin{array}{|c|c|} \hline 1 & 2 \\ \hline 2 & \\ \hline \end{array}, \\ \begin{array}{|c|c|} \hline 1 & 1 \\ \hline 2 & \\ \hline \end{array}, & \begin{array}{|c|c|} \hline 1 & 3 \\ \hline 2 & \\ \hline \end{array}, & \begin{array}{|c|c|} \hline 1 & 4 \\ \hline 2 & \\ \hline \end{array}, & \begin{array}{|c|c|} \hline 1 & 5 \\ \hline 2 & \\ \hline \end{array}, & \begin{array}{|c|c|} \hline 1 & 6 \\ \hline 2 & \\ \hline \end{array}, & \begin{array}{|c|c|} \hline 1 & 7 \\ \hline 2 & \\ \hline \end{array} \end{array} \right).$$

All these tableaux are in $\mathcal{S}_{G_2}(1, 1)$.

□

Now we define a mapping f from $\mathcal{S}_{G_2}(p, q)$ into $\bigsqcup_{\substack{p' \leq p \\ q' \leq q}} \mathcal{QS}_{G_2}(p', q')$ as follows.

Let T be in $\mathcal{S}_{G_2}(p, q)$, if T is quasi standard, we put $f(T) = T$, if T is not quasi standard, we put $T' = R(P(T))$. If T' is quasi standard, we define $f(T) = T'$. If it is not the case, we put $T'' = R(P(T'))$, if T'' is quasi standard, we put $f(T) = T''$ and so one...

Proposition 6.5.

f is a one-to-one onto mapping from $\mathcal{S}_{G_2}(p, q)$ onto $\bigsqcup_{\substack{p' \leq p \\ q' \leq q}} \mathcal{QS}_{G_2}(p', q')$.

Proof:

We just define the inverse mapping of f . Let T be in $\mathcal{S}_{G_2}(p', q')$. Suppose that $q' \leq q$. We first compute $R^{-1}(T)$ i.e we replace each 2-column of T in the “acceptable columns” in the table 1 by the corresponding wrong columns. Let

$$R^{-1} = \begin{array}{|c|c|c|c|c|c|} \hline a'_1 & \cdots & a'_p & a'_{p+1} & \cdots & a'_{p+q} \\ \hline b'_1 & \cdots & b'_p & & & \\ \hline \end{array}$$

the resulting tableau. Then we ‘pull’ the resulting tableau, that is we define :

$$P^{-1}(R^{-1}(T)) = T' = \begin{array}{|c|c|c|c|c|c|c|} \hline 1 & a'_1 & \cdots & a'_{p-1} & a'_p & \cdots & a'_{p+q} \\ \hline b'_1 & b'_2 & \cdots & b_p & & & \\ \hline \end{array}.$$

We verify, case by case as above, that the resulting tableau T' is in $\mathcal{S}_{G_2}(p', q' + 1)$. If $q' + 1 < q$, we repeat this operation.

Finally, we get a tableau $T'' = (P^{-1} \circ R^{-1}) \circ \dots \circ (P^{-1} \circ R^{-1})(T) \in \mathcal{S}_{G_2}(p', q)$. If $p' < p$, we add to T'' $p - p'$ trivial 2-columns $\begin{array}{|c|} \hline 1 \\ \hline 2 \\ \hline \end{array}$. By construction, the mapping g so defined from $\bigsqcup_{\substack{p' \leq p \\ q' \leq q}} \mathcal{QS}_{G_2}(p', q')$ is the inverse mapping of f .

Let us recall the projection mapping $\pi : \mathbb{S}_{G_2} = \bigoplus_{p,q} \Gamma_{q,p} \longrightarrow \mathbb{S}_{G_2}^{red}$. We show that if $p' \leq p, q' \leq q$, then $\pi(\Gamma_{q',p'}) \subset \Gamma_{q,p}$. Now, our proposition proves by induction on p and q that:

$$\#\mathcal{QS}_{G_2}(p, q) = \dim(\pi(\Gamma_{q,p})) \Big/ \sum_{(p',q') < (p,q)} \pi(\Gamma_{q',p'})$$

where $(p', q') < (p, q)$ means $p' \leq p, q' \leq q$ and $(p', q') \neq (p, q)$.

Proposition 6.6.

The set $\mathcal{QS}_{G_2}(p, q)$ is a basis for a supplementary space $W_{p,q}$ in $\pi(\Gamma_{q,p})$ to the space $\sum_{(p',q') < (p,q)} \pi(\Gamma_{q',p'})$.

Proof:

Since the number of quasi standard tableaux is the dimension of our space, it is enough to prove that the family $\mathcal{QS}_{G_2}(p, q)$ is independant in the quotient

$$\pi(\Gamma_{q,p}) \Big/ \sum_{(p',q') < (p,q)} \pi(\Gamma_{q',p'}).$$

Suppose this is not the case, there is a linear relation $\sum_i a_i T_i$ between some T_i in

$\mathcal{QS}_{G_2}(p, q)$ which belongs to $\sum_{(p',q') < (p,q)} \pi(\Gamma_{q',p'})$ that means, there is a S in the ideal

\mathcal{PL}_{red} of reduced Plücker ideal, a family (T'_j) of tableaux in $\cup_{(p',q') < (p,q)} \mathcal{S}_{G_2}(p', q')$ and $b_j \in \mathbb{R}$ such that: $\sum_i a_i T_i = \sum_j b_j T'_j + S$. This means

$$\left(\sum_i a_i T_i - \sum_j b_j T'_j \right) |_{N^-} = 0. \quad (1)$$

But now the action of the diagonal matrices $H \in \mathfrak{h}$ in G_2 are diagonalized in $\mathbb{C}[\mathcal{C}]$

where \mathcal{C} is the set of the polynomial functions $\begin{matrix} \boxed{i_1} \\ \boxed{i_2} \\ \vdots \\ \boxed{i_r} \end{matrix}$ already defined in section 1.

Thus we decompose the preceding expression in a finite sum of weight vectors with weight $\mu \in \mathfrak{h}^*$. The relation (1) holds for any weight vector, thus we get:

$$\left(\sum_i a_i T_i - \sum_j b_j T'_j \right) |_{N^-} = 0,$$

$$H. \left(\sum_i a_i T_i - \sum_j b_j T'_j \right) = \mu(H) \left(\sum_i a_i T_i - \sum_j b_j T'_j \right).$$

The first relation means there is S_μ in the ideal \mathcal{PL}_{red} such that:

$$\sum_i a_i T_i - \sum_j b_j T'_j = S_\mu.$$

S_μ being in \mathcal{PL}_{red} can be written as:

$$S_\mu = \sum_k PL_k + \sum_l T'_l \left(\begin{matrix} \boxed{1} \\ \boxed{2} \end{matrix} - 1 \right) + \sum_m T''_m \left(\begin{matrix} \boxed{1} \\ \boxed{2} \end{matrix} - 1 \right)$$

where PL_k are Plücker relations which are homogeneous, with weight μ , with respect to the \mathfrak{h} action. Let us put

$$U = \sum_i a_i T_i - \sum_j b_j T'_j - \sum_k PL_k.$$

U is a linear combination of Young tableaux $U = \sum_\ell c_\ell U_\ell$, it is homogeneous with weight μ . If we suppress the trivial columns of each the U_ℓ tableau, we get a tableau U'_ℓ of weight $\mu - a\omega_1 - b\omega_2$, if there is a columns $\begin{matrix} \boxed{1} \\ \boxed{2} \end{matrix}$ and b columns $\begin{matrix} \boxed{1} \\ \boxed{2} \end{matrix}$. Now to suppress these columns corresponds exactly to the restriction of the corresponding polynomial functions to N^- . Denoting by $'$ the restriction to N^- , we get :

$$U' = \sum_\ell c_\ell U'_\ell = 0.$$

For any (a, b) , we put $M_{(a,b)} = \{\ell, \text{ such that } U'_\ell \text{ has weight } \mu - a\omega_1 - b\omega_2\}$ then for any (a, b) , by homogeneity,

$$\sum_{\ell \in M_{(a,b)}} c_\ell U_\ell = 0.$$

Finally,

$$U = \sum_{a,b} \left(\begin{array}{c} 1 \\ 2 \end{array} \right)^b \sum_{\ell \in M_{(a,b)}} c_\ell U_\ell \left(\begin{array}{c} 1 \\ 1 \end{array} \right)^a = 0.$$

This proves our proposition. □

Finally we can compute the semi standard non quasi standard minimal tableaux for G_2 , without any trivial column :

$$\left\{ \begin{array}{l} \begin{array}{c} 1\ 2 \\ 3 \end{array}, \begin{array}{c} 1\ 2 \\ 4 \end{array}, \begin{array}{c} 1\ 2 \\ 5 \end{array}, \begin{array}{c} 1\ 3 \\ 4 \end{array}, \begin{array}{c} 1\ 3 \\ 5 \end{array}, \begin{array}{c} 1\ 3 \\ 6 \end{array}, \begin{array}{c} 1\ 4 \\ 4 \end{array}, \begin{array}{c} 1\ 4 \\ 5 \end{array}, \begin{array}{c} 1\ 4 \\ 6 \end{array}, \begin{array}{c} 1\ 5 \\ 6 \end{array}, \\ \begin{array}{c} 1\ 5 \\ 7 \end{array}, \begin{array}{c} 1\ 6 \\ 7 \end{array}, \begin{array}{c} 1\ 2\ 3 \\ 3\ 5 \end{array}, \begin{array}{c} 1\ 2\ 4 \\ 3\ 5 \end{array}, \begin{array}{c} 1\ 2\ 3 \\ 3\ 6 \end{array}, \begin{array}{c} 1\ 2\ 4 \\ 3\ 6 \end{array}, \begin{array}{c} 1\ 2\ 5 \\ 3\ 3 \end{array}, \begin{array}{c} 1\ 2\ 5 \\ 3\ 7 \end{array}, \\ \begin{array}{c} 1\ 2\ 6 \\ 3\ 7 \end{array}, \begin{array}{c} 1\ 2\ 4 \\ 4\ 5 \end{array}, \begin{array}{c} 1\ 2\ 4 \\ 4\ 6 \end{array}, \begin{array}{c} 1\ 2\ 5 \\ 4\ 6 \end{array}, \begin{array}{c} 1\ 3\ 4 \\ 4\ 6 \end{array}, \begin{array}{c} 1\ 3\ 5 \\ 4\ 6 \end{array}, \begin{array}{c} 1\ 2\ 5 \\ 4\ 7 \end{array}, \begin{array}{c} 1\ 2\ 6 \\ 4\ 7 \end{array}, \\ \begin{array}{c} 1\ 3\ 5 \\ 4\ 7 \end{array}, \begin{array}{c} 1\ 3\ 6 \\ 4\ 7 \end{array}, \begin{array}{c} 1\ 2\ 5 \\ 5\ 6 \end{array}, \begin{array}{c} 1\ 3\ 5 \\ 5\ 6 \end{array}, \begin{array}{c} 1\ 2\ 5 \\ 5\ 7 \end{array}, \begin{array}{c} 1\ 2\ 6 \\ 5\ 7 \end{array}, \begin{array}{c} 1\ 3\ 5 \\ 5\ 7 \end{array}, \begin{array}{c} 1\ 3\ 6 \\ 5\ 7 \end{array}, \\ \begin{array}{c} 1\ 4\ 5 \\ 5\ 7 \end{array}, \begin{array}{c} 1\ 4\ 6 \\ 5\ 7 \end{array}, \begin{array}{c} 1\ 3\ 6 \\ 6\ 7 \end{array}, \begin{array}{c} 1\ 4\ 6 \\ 6\ 7 \end{array}, \begin{array}{c} 1\ 5\ 6 \\ 6\ 7 \end{array}, \begin{array}{c} 1\ 2\ 3\ 5 \\ 3\ 5\ 6 \end{array}, \begin{array}{c} 1\ 2\ 3\ 6 \\ 3\ 6\ 7 \end{array}, \\ \begin{array}{c} 1\ 2\ 4\ 6 \\ 3\ 6\ 7 \end{array}, \begin{array}{c} 1\ 2\ 5\ 6 \\ 3\ 6\ 7 \end{array}, \begin{array}{c} 1\ 2\ 3\ 5 \\ 3\ 5\ 7 \end{array}, \begin{array}{c} 1\ 2\ 4\ 5 \\ 3\ 5\ 7 \end{array}, \begin{array}{c} 1\ 2\ 3\ 6 \\ 3\ 5\ 7 \end{array}, \begin{array}{c} 1\ 2\ 4\ 6 \\ 3\ 5\ 7 \end{array}, \\ \begin{array}{c} 1\ 2\ 4\ 5 \\ 4\ 5\ 7 \end{array}, \begin{array}{c} 1\ 2\ 4\ 6 \\ 4\ 5\ 7 \end{array}, \begin{array}{c} 1\ 2\ 4\ 7 \\ 4\ 5\ 7 \end{array}, \begin{array}{c} 1\ 2\ 4\ 6 \\ 4\ 6\ 7 \end{array}, \begin{array}{c} 1\ 2\ 5\ 6 \\ 4\ 6\ 7 \end{array}, \begin{array}{c} 1\ 3\ 4\ 6 \\ 4\ 6\ 7 \end{array}, \\ \begin{array}{c} 1\ 3\ 5\ 6 \\ 4\ 6\ 7 \end{array}, \begin{array}{c} 1\ 2\ 5\ 6 \\ 5\ 6\ 7 \end{array}, \begin{array}{c} 1\ 3\ 5\ 6 \\ 5\ 6\ 7 \end{array}, \begin{array}{c} 1\ 2\ 3\ 5\ 6 \\ 3\ 5\ 6\ 7 \end{array} \end{array} \right\}.$$

Now, for G_2 , the picture of a part of the diamond cone is as follows :

REFERENCES

- [ABW] D. Arnal, N. Bel Baraka, N. Wildberger : “Diamond representations of $\mathfrak{sl}(n)$ ”, International Journal of Algebra and Computation, **13** n°2 (2006), 381–429
- [ADLMPPrW] L. W. Alverson II, R. G. Donnelly, S. J. Lewis, M. McClard, R. Pervine, R. A. Proctor, N. J. Wildberger, “Distributive lattice defined for representations of rank two semisimple Lie algebras” ArXiv 0707.2421 v 1 (2007)
- [FH] W. Fulton and J. Harris, “Representation theory”; Readings in Mathematics. **129**(1991) Springer- Verlag, New York.
- [V] V.S. Varadarajan “Lie groups, Lie algebras, and their representations“; Springer-Verlag, New York ; Berlin (1984).
- [W] N. J. Wildberger “A combinatorial construction of G_2 ”, J. of Lie theory, vol 13 (2003)

DÉPARTEMENT DE MATHÉMATIQUES, FACULTÉ DES SCIENCES DE SFAX, ROUTE DE SOUKRA, KM 3,5, B.P. 1171, 3000 SFAX, TUNISIE.

E-mail address: bagrebaoui@yahoo.fr

INSTITUT DE MATHÉMATIQUE DE BOURGOGNE, UMR CNRS 5584, UNIVERSITÉ DE BOURGOGNE, U. F. R. SCIENCES ET TECHNIQUES, B. P. 47870, F- 21078 DIJON CEDEX, FRANCE.

E-mail address: Didier.Arnal@u-bourgogne.fr

DÉPARTEMENT DE MATHÉMATIQUES, FACULTÉ DES SCIENCES DE SFAX, ROUTE DE SOUKRA, KM 3,5, B.P. 1171, 3000 SFAX, TUNISIE.

E-mail address: khlifi_olfa@yahoo.fr