

Concordant Chemical Reaction Networks and the Species-Reaction Graph

Guy Shinar* Martin Feinberg^{†‡}

April 3, 2018

Abstract

In a recent paper it was shown that, for chemical reaction networks possessing a subtle structural property called *concordance*, dynamical behavior of a very circumscribed (and largely stable) kind is enforced, so long as the kinetics lies within the very broad and natural *weakly monotonic* class. In particular, multiple equilibria are precluded, as are degenerate positive equilibria. Moreover, under certain circumstances, also related to concordance, all real eigenvalues associated with a positive equilibrium are negative. Although concordance of a reaction network can be decided by readily available computational means, we show here that, when a nondegenerate network's *Species-Reaction Graph* satisfies certain mild conditions, concordance and its dynamical consequences are ensured. These conditions are weaker than earlier ones invoked to establish kinetic system injectivity, which, in turn, is just one ramification of network concordance. Because the Species-Reaction Graph resembles pathway depictions often drawn by biochemists, results here expand the possibility of inferring significant dynamical information directly from standard biochemical reaction diagrams.

*InBrain Therapeutics Ltd., 12 Metzada St., Ramat Gan 52235, Israel. E-mail: shinar@gmail.com. Work initiated while GS was in the Department of Molecular Cell Biology, Weizmann Institute of Science, Rehovot 76100, Israel.

[†]The William G. Lowrie Department of Chemical & Biomolecular Engineering and Department of Mathematics, Ohio State University, 140 W. 19th Avenue, Columbus, OH, USA 43210. E-mail: feinberg.14@osu.edu. MF was supported by NSF grant EF-1038394 and NIH grant 1R01GM086881-01.

[‡]Corresponding author. Phone: 614-688-4883.

Contents

1	Introduction	4
1.1	Background	4
1.2	The role of the Species-Reaction Graph	4
1.2.1	The Species-Reaction Graph and the concordance of “fully open” networks	5
1.2.2	The Species-Reaction Graph and the concordance of networks that are not “fully open”	6
1.3	The Species-Reaction Graph and consequences of concordance	8
2	Main theorems	8
3	Reaction network theory preliminaries	15
3.1	Notation	15
3.2	Some definitions	17
4	Concordant reaction networks	22
5	Proof of Theorem 2.1	24
5.1	Preliminaries	25
5.2	The sign-causality graph and causal units	25
5.3	The sign-causality graph must contain a directed cycle, and all of its directed cycles are even.	28
5.4	Inequalities associated with a source; stoichiometric coeffi- cients associated with edges in the sign-causality graph	29
5.5	The decomposition of a source into its blocks; the block-tree of a source	32
5.6	Properties of source-blocks	34
5.7	Properties of an end S-block	35
5.7.1	Possibilities 1 and 2: ESB contains no separating ver- tex of the source or it contains a separating reaction vertex of the source	35
5.7.2	Possibility 3: ESB contains a separating species vertex of the source	36
5.8	Properties of an end R-block	37

5.8.1	Possibilities 1 and 2: ERB contains no separating vertex of the source or it contains a separating reaction vertex of the source	38
5.8.2	Possibility 3: ERB contains a separating species vertex of the source	39
5.9	The concluding argument: Leaf removal	39
6	Proof of Theorem 2.6	41
7	Extensions of the main theorems to networks that are not fully open	42
7.1	Network normality, weak normality, and nondegeneracy	43
7.2	Concordance of a network and of its fully open extension . . .	46
7.3	Tests for network normality, weak normality, and nondegeneracy	47
8	A Concluding Remark	50
	Appendices	51
A	Proof of Propositions 5.8 and 5.10	51
A.1	Some graph theoretical preliminaries: Ears	51
A.2	Two lemmas about R-to-R and S-to-S intersections of even cycles	52
A.3	Proof of Proposition 5.8	55
A.4	Proof of Proposition 5.10	60
B	Proof of Proposition 5.12.	63
C	Proof of Lemma 6.2	67

1 Introduction

1.1 Background

This article is intended as a supplement to another one [18], in which we defined the large class of *concordant chemical reaction networks*¹ and deduced many of the striking properties common to all members of that class. We argued that, so long as the kinetics is weakly monotonic (§3.2), network concordance enforces behavior of a very circumscribed kind.

Among other things, we showed that the class of concordant networks coincides *precisely* with the class of networks which, when taken with any weakly monotonic kinetics, invariably give rise to kinetic systems that are *injective* — a quality that precludes, for example, the possibility of switch-like transitions between distinct positive stoichiometrically compatible steady states. Moreover, we showed that certain properties of concordant networks taken with weakly monotonic kinetics extend to still broader categories of kinetics — including kinetics that involve product inhibition — provided that the networks considered are not only concordant but also *strongly concordant* [18].

Although reaction network concordance is a subtle structural property, determination of whether or not a network is concordant (or strongly concordant) is readily accomplished with the help of easy-to-use and freely available software [15], at least if the network is of moderate size.² In this way, one can easily determine whether the several dynamical consequences of concordance or strong concordance accrue to a particular reaction network of interest.

1.2 The role of the Species-Reaction Graph

The *Species-Reaction Graph* (SR Graph), defined in Section 2, is a graphical depiction of a chemical reaction network resembling pathway diagrams often drawn by biochemists. For so-called “fully open” systems (§1.2.1), earlier work [1,2,7,9] indicated that, when the SR Graph satisfies certain structural conditions and when the kinetics is within a specified class, the governing differential equations can only admit behavior of a restricted kind. A survey of some of that earlier work, beginning with the Ph.D. research of Paul

¹The formal definitions of concordance and strong concordance appear here in Sections 4 and 6.

²Some of the underlying algorithms are given in [14].

Schlosser [16,17] is provided in [18]. Although most of the initial SR Graph results for fully open networks were focused on mass action kinetics, that changed with the surprising work of Banaji and Craciun [1,2]. (In contrast to the SR Graph results, however, the network analysis tools in [15] are indifferent to whether the network is fully open.)

With this as background, in [18] we asserted without proof that attributes of the SR Graph shown earlier to be sufficient for other network properties [1,2,7,9] are, in fact, sufficient to ensure not only concordance but also strong concordance, at least in the “fully open” setting. In turn, those other properties (e.g., the absence of multiple steady states when the kinetics is weakly monotonic) largely *derive* from concordance. *That certain SR Graph attributes might ensure concordance seems, then, to be the fundamental idea, with attendant dynamical consequences of those same SR Graph attributes ultimately descending from concordance.*

Although handy computational tools in [15] will generally be more incisive than the SR Graph in determining a network’s concordance properties and although those computational tools are indifferent to whether the network is fully open, the SR Graph nevertheless has its strong attractions. Not least of these is the close relationship that the SR Graph bears to reaction network diagrams often drawn by biochemists. For this reason alone, far-from-obvious dynamical consequences that might be inferred from these ubiquitous diagrams take on considerable interest. Moreover, theorems that tie network concordance to properties of the SR Graph point to consequences of reaction network structure that are not easily gleaned from implementation of computational tests on a case-by-case basis.

Thus, our primary purpose here is to prove the assertions made in [18] about connections between concordance of a network and the nature of its SR Graph. In fact, we go further in two directions, directions that would have been somewhat askew to the main thrusts of [18]:

1.2.1 The Species-Reaction Graph and the concordance of “fully open” networks

First, we show that one can infer concordance of a so-called “fully open” network when its SR graph satisfies conditions, stated in Theorem 2.1, that are substantially weaker than those stated in [18] (or in [1,2,7,9]); Corollary 2.4 invokes the SR Graph conditions stated in [18]. A fully open network is one containing a “degradation reaction” $s \rightarrow 0$ for each species s in the net-

work.³ Proof of concordance when the aforementioned SR Graph conditions are satisfied is by far the main undertaking of this article.

1.2.2 The Species-Reaction Graph and the concordance of networks that are not “fully open”

Second, we examine more completely concordance information that the SR Graph gives for reaction networks that are *not* fully open.

For a network that is not fully open, its *fully open extension* is the network obtained from the original one by adding degradation reactions for all species for which such degradation reactions are not already present. In [18] we proved that a *normal* network is concordant (respectively, strongly concordant) if its fully open extension is concordant (strongly concordant). A normal network is one satisfying a very mild condition described in [8], [18], and, here again, in §7.1. *The large class of normal networks includes all weakly reversible networks and, in particular, all reversible networks [8].*

Thus, if inspection of the SR Graph can serve to establish, by means of theorems crafted for *fully open networks*, that a *normal* network’s fully open extension is concordant or strongly concordant, *then the original network itself has that same property.* In this way, the seemingly restricted power of “fully open” SR graph theorems extends far beyond the fully open setting.

This has some importance, especially in relation to reversible networks. Consider a reaction network whose SR Graph ensures, by virtue of Corollary 2.4, concordance of the network’s fully open extension. Then the original network can *fail* to be concordant only if it is not reversible. But a kinetic system based on a network that is not reversible is usually deemed to be an approximation of a more exact “nearby” kinetic system in which all reactions are reversible, perhaps with some reverse reactions having extremely small rates.

To the extent that this is the case, lack of concordance in the original network is an artifact of the approximation: The reversible network underlying the more exact kinetic system is concordant, so that system inherits all of the dynamical properties in [18] that are consequences of network concordance. (In particular, it inherits those properties listed as items (i) – (iii) in Theorem 2.8.) Thus, any absence of these attributes in a kinetic system based on the original network is, again, an artifact of the approximation.

³Nevertheless, the SR graph is drawn for the so-called “true” chemistry, devoid of degradation-synthesis reactions such as $s \rightarrow 0$ or $0 \rightarrow s$.

Even so, kinetic system models based on networks that are not reversible (or, more generally, weakly reversible) have an intrinsic interest. They are ubiquitous, and one would like to understand their inherent properties. Results in [18] about network normality and concordance already go a long way in this direction, for the class of normal networks extends well beyond the weakly reversible class.

Here we argue that these same results extend to the still larger class of *nondegenerate* reaction networks, a class that includes all normal networks and, in particular, all weakly reversible networks. A network is nondegenerate if, taken with *some* differentially monotonic kinetics [18], the resulting kinetic system admits *even one* positive composition at which the derivative of the species-formation-function is nonsingular⁴; otherwise we say that the network is *degenerate* (Definition 7.6).

In fact, degenerate reaction networks are *never* concordant (§7.1), so for them questions about the possibility of concordance are moot. On the other hand, a *nondegenerate* network is concordant (strongly concordant) if the network's fully open extension is concordant (strongly concordant) (§7.2). *Thus, SR Graph theorems that give information about the concordance or strong concordance of a nondegenerate network's fully open extension give that same information about the network itself.*

Implications of network normality were considered in some depth in [18]. Because corresponding considerations of the broader notion of nondegeneracy are similar and because those considerations are rather different in spirit from the largely graph-theoretical aspects of most of this article, we chose to defer the entire discussion of nondegeneracy to Section 7, which includes computational tests whereby normality and nondegeneracy of a network can be affirmed.

In any case, it should be kept in mind that the computational tools provided in [15] are indifferent to whether the network under study is fully open (or nondegenerate).

⁴A positive composition is one at which all species concentrations are (strictly) positive. When we say that the derivative (Jacobian matrix) of the species-formation rate function is nonsingular we mean that its null space contains no nonzero vector of the stoichiometric subspace.

1.3 The Species-Reaction Graph and consequences of concordance

For the most part the theorems in this article have as their objective the drawing of connections between the concordance of a reaction network and properties of the network's Species-Reaction Graph. However, it is important to keep in mind the dynamical consequences of these theorems. When an SR Graph theorem asserts concordance of a particular network, *the same theorem is also asserting that the network inherits all of the properties shown in [18] to accrue to all concordant networks.*

Thus, for example, a theorem that asserts concordance for any reaction network whose SR Graph has Property X is *also* asserting that, for any reaction network whose SR Graph has Property X, *there is no possibility of two distinct stoichiometrically compatible equilibria, at least one of which is positive, no matter what the kinetics might be, so long as it is weakly monotonic.*

A theorem that does make explicit connections between the SR Graph and dynamical consequences is offered at the close of the next section.

2 Main theorems

The *Species-Reaction Graph (SR Graph)* of a chemical reaction network is a bipartite graph constructed in the following way: The vertices are of two kinds — *species vertices* and *reaction vertices*. The species vertices are simply the species of the network. The reaction vertices are the reactions of the network but with the understanding that a reversible reaction pair such as $A + B \rightleftharpoons P$ is identified with a single vertex. If a species appears in a particular reaction, then an edge is drawn that connects the species with that reaction, and the edge is labeled with the name of the complex in which the species appears. (The *complexes* of a reaction network are the objects that appear before and after the reaction arrows. Thus, the complexes of reaction $A + B \rightarrow P$ are $A + B$ and P .) The *stoichiometric coefficient of an edge* is the stoichiometric coefficient of the adjacent species in the labeling complex. We show the Species-Reaction Graph for network (1) in Figure 1. The arrows on some of the edges will be explained shortly.

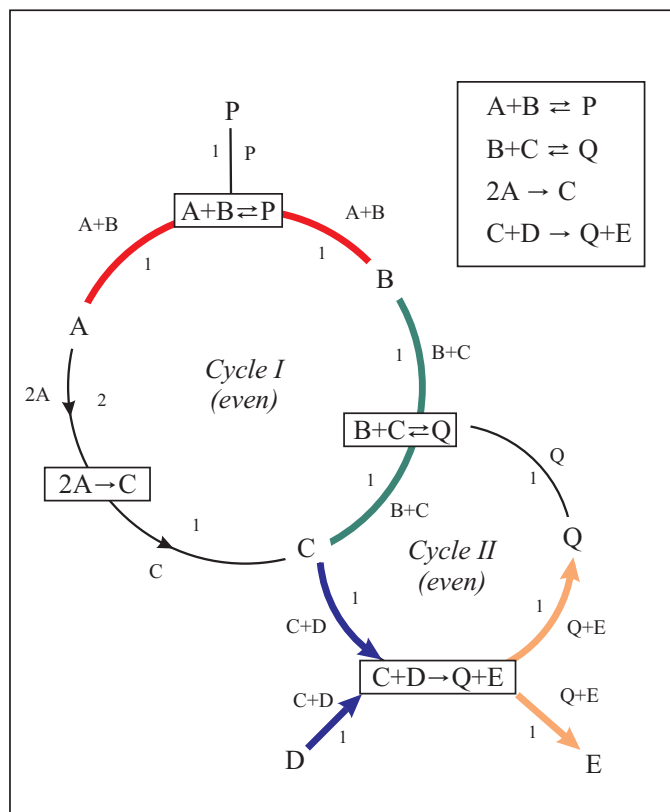

Figure 1: An example of a Species-Reaction Graph

It will be understood that our focus is on concordance of a “fully open” reaction network $\{\mathcal{S}, \mathcal{C}, \mathcal{R}\}$. To say that the network is fully open is to say that, for each species s in the network there is a “degradation reaction” of the form $s \rightarrow 0$. (There might also be “synthesis reactions” of the form $0 \rightarrow s$.) Moreover, we shall also suppose hereafter that a species can appear on only one side of a reaction. The first of these requirements was invoked in [2, 5, 7], while the second was invoked only in [2].

Even in consideration of fully open reaction networks we will always restrict our attention to the Species-Reaction Graph for the “true chemistry” — that is, the Species-Reaction Graph for the original fully open network but with degradation-synthesis “reactions” such as $A \rightarrow 0$ or $0 \rightarrow A$ omitted. As a reminder we will sometimes refer to the “true-chemistry Species-Reaction Graph,” but this understanding will always be implicit even when it is not made explicit.

By the *intersection of two cycles* in the Species-Reaction Graph, we mean the subgraph consisting of all vertices and edges common to the two cycles. We say that two cycles have a *species-to-reaction intersection (S-to-R intersection)* if their intersection is not empty and each of the connected components of the intersection is a path having a species at one end and a reaction at the other. In the phrase “S-to-R intersection” no directionality is implied. In Figure 1, Cycle I and Cycle II have an S-to-R intersection consisting of the edge connecting species C to reactions $B + C \rightleftharpoons Q$. There is a third unlabeled “outer” cycle, hereafter called Cycle III, that traverses species A, C, Q, B and returns to A . It has an S-to-R intersection with Cycle I, in particular, the long outer path connecting reactions $B + C \rightleftharpoons Q$ to species C via species A . Cycle III also has an S-to-R intersection with Cycle II.

An *edge-pair* in the SR Graph is a pair of edges adjacent to a common *reaction* vertex. A *c-pair* (abbreviation for *complex-pair*) is an edge-pair whose edges carry the same complex label. For readers with access to color, the c-pairs in Figure 1 are given distinct colors.

An *even cycle* in the SR Graph is a cycle whose edges contain an even number of c-pairs.⁵ Cycle I contains two c-pairs and Cycle II contains none, so both are even. Cycle III, the large outer cycle, contains one c-pair, so it is not even.

A *fixed-direction edge-pair* is an edge-pair that is not a c-pair and for which the reaction of the edge-pair is irreversible. In this case, we assign a *fixed direction* to each of the two edges in the intuitively obvious way: The edge adjacent to the reactant species (i.e., the species appearing in the reactant complex) is directed away from that species, and the edge adjacent to the product species (i.e., the species appearing in the product complex) points toward that species. Thus, for example, a fixed-direction edge-pair

⁵In the graph theory literature, the term “even cycle” sometimes refers to a cycle containing an even number of edges. That is never the usage here. In a bipartite graph — in particular in an SR graph — cycles *always* have an even number of edges.

such as

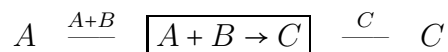

has the fixed direction

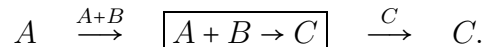

In Figure 1 there are fixed-direction edge-pairs centered at the reactions $2A \rightarrow C$ and $C + D \rightarrow Q + E$; the corresponding fixed-directions for the adjacent edges are shown in the figure.

An *orientation* for a simple cycle $s_1 R_1 s_2 R_2 \dots s_n R_n s_1$ in the SR Graph is an assignment of one of two directions to the edges, either

$$s_1 \rightarrow R_1 \rightarrow s_2 \rightarrow R_2 \dots \rightarrow s_n \rightarrow R_n \rightarrow s_1$$

or

$$s_1 \leftarrow R_1 \leftarrow s_2 \leftarrow R_2 \dots \leftarrow s_n \leftarrow R_n \leftarrow s_1,$$

that is consistent with any fixed directions the cycle might contain. A cycle is *orientable* if it admits at least one orientation. By an *oriented cycle* in the SR Graph we mean an orientable cycle taken with a choice of orientation.

Note that a cycle that has no fixed-direction edge-pair will be orientable and have two orientations. (This happens when every reaction in the cycle is either reversible or else is contained in a c-pair within the cycle.) A cycle that has just one fixed-direction edge-pair is orientable and has a unique orientation. A cycle that has more than one fixed-direction edge-pair might or might not be orientable, depending on whether the fixed-direction edge-pairs all point “clockwise” or “counterclockwise,” but if there is an orientation it will be unique. All cycles in Figure 1 are orientable, with each cycle having a unique orientation.

A set of cycles in an SR graph *admits a consistent orientation* if the cycles can all be assigned orientations such that each edge contained in one of the cycles has the same orientation-direction in every cycle of the set in which that edge appears. To see that a set of cycles might not admit a consistent orientation, consider a pair of cycles sharing a common edge, each cycle having the same compulsory orientation (e.g., “clockwise”). In fact, this is precisely the situation for Cycles I and II, so the set consisting of those two cycles does not admit a consistent orientation. On the other hand the set

consisting of Cycles I and III (the large outer cycle) does admit a consistent orientation, as does the set consisting of Cycles II and III.

A *critical subgraph* of an SR Graph is a union of a set of *even* cycles taken from the SR Graph that admits a consistent orientation. Because Cycle III is not even, it is easy to see that there are only two critical subgraphs in Figure 1: One consists only of Cycle I and the other consists only of Cycle II.

Consider an oriented cycle in the SR Graph, $s_1 \rightarrow R_1 \rightarrow s_2 \rightarrow R_2 \dots \rightarrow s_n \rightarrow R_n \rightarrow s_1$. For each directed reaction-to-species edge $R \rightarrow s$ we denote by $f_{R \rightarrow s}$ the stoichiometric coefficient associated with that edge. For each directed species-to-reaction edge, we denote by $e_{s \rightarrow R}$ the stoichiometric coefficient associated with it. The cycle is *stoichiometrically expansive* relative to the given orientation if

$$\frac{f_{R_1 \rightarrow s_2} f_{R_2 \rightarrow s_3} \cdots f_{R_n \rightarrow s_1}}{e_{s_1 \rightarrow R_1} e_{s_2 \rightarrow R_2} \cdots e_{s_n \rightarrow R_n}} > 1. \quad (2)$$

One of the major goals of this article is proof of the following theorem:

Theorem 2.1. *A fully open reaction network is concordant if its true-chemistry Species-Reaction Graph has the following properties:*

- (i) *No even cycle admits a stoichiometrically expansive orientation.*
- (ii) *In no critical subgraph do two even cycles have a species-to-reaction intersection.*

Remark 2.2. If there are no critical subgraphs — in particular if there are no orientable even cycles — then the conditions of the theorem are satisfied trivially, and the network is concordant.

Remark 2.3. Determination of which subgraphs of the Species-Reaction Graph are critical requires consideration of orientability. However, it should be understood that condition (ii) of Theorem 2.1 is imposed on every *undirected* critical subgraph of the *undirected* Species-Reaction Graph. In particular, account should be taken of all even cycles in the subgraph, whether or not they be orientable. (Although, a critical subgraph is the union of a set of even cycles that admit a consistent orientation, the resulting subgraph might also contain cycles that are not orientable.) Again, no directionality should be associated with the phrase “species-to-reaction” intersection.

With regard to condition (i), note that a cycle that admits two orientations can be non-expansive relative to both orientations only if, relative to

one of the orientations, the number on the left side of (2) is *equal to one* (in which case it will also have that same value with respect to the opposite orientation).

In the language of [2,6,9], we say that a (not necessarily orientable) cycle in the SR Graph is an *s-cycle* if relative to an arbitrarily imposed “clockwise” direction, the calculation on the left side of (2) yields the value *one*. With this in mind we can state an “orientation-free” corollary of Theorem 2.1:

Corollary 2.4. *A fully open reaction network is concordant if its true-chemistry Species-Reaction Graph has the following properties:*

- (i) *Every even cycle is an s-cycle.*
- (ii) *No two even cycles have a species-to-reaction intersection.*

Especially for networks in which there are several irreversible reactions, Theorem 2.1 is likely to be more incisive than its corollary. Consider, for example, the Species-Reaction Graph for network (1). *Both* conditions of Corollary 2.4 fail. Nevertheless, *both* of the (weaker) conditions of Theorem 2.1 are satisfied, so a fully open network having (1) as its true chemistry is concordant.

Remark 2.5. We shall see very easily in Section 7 that network (1) is normal. Because every normal network with a concordant fully open extension is itself concordant, we can conclude that network (1), like its fully open extension, is concordant.

When a fully open network *does* satisfy the stronger conditions of Corollary 2.4 we can say more, this time about *strong* concordance.

Theorem 2.6. *A fully open reaction network is strongly concordant if its true-chemistry Species-Reaction Graph has the following properties:*

- (i) *Every even cycle is an s-cycle.*
- (ii) *No two even cycles have a species-to-reaction intersection.*

Although the fully open extension of network (1) is concordant, it is not strongly concordant. (This can be quickly determined by the freely available *Chemical Reaction Network Toolbox* [15].) The Species-Reaction Graph for network (1) does not satisfy the conditions of Theorem 2.6.

Remark 2.7. Although these theorems nominally speak in terms of concordance or strong concordance of a fully open network, they are even more generous than they seem: Recall that in Section 7 we indicate why the concordance properties ensured by the theorems actually extend beyond the fully open setting to a far wider class of reaction networks. In particular, they extend to the class of *nondegenerate* networks described earlier in §1.2.2 (including *all* weakly reversible networks). For nondegenerate networks, then, the fully open requirement of Theorems 2.1 and 2.6 becomes moot.

In the spirit of §1.3 we close this section with the statement of a theorem that ties the hypothesis of Theorem 2.1 not to concordance itself but, instead, to dynamical consequences of concordance proved in [18]. The following theorem is essentially a corollary of Theorem 2.6, theorems in [18], and material to be discussed in Section 7. Language in the theorem is that used in [18]. Much of it is reviewed in Section 3 of this article.

Theorem 2.8. *For any nondegenerate reaction network whose true chemistry Species-Reaction Graph satisfies conditions (i) and (ii) of Theorem 2.1 the following statements hold true:*

(i) *For each choice of weakly monotonic kinetics, every positive equilibrium is unique within its stoichiometric compatibility class. That is, no positive equilibrium is stoichiometrically compatible with a different equilibrium, positive or otherwise.*

(ii) *If the network is weakly reversible then, for each choice of kinetics (not necessarily weakly monotonic), no nontrivial stoichiometric compatibility class has an equilibrium on its boundary. In fact, at each boundary composition in any non-trivial stoichiometric compatibility class the species-formation-rate vector points into the stoichiometric compatibility class in the sense that there is an absent species produced at strictly positive rate. If, in addition, the network is conservative then, for any choice of a continuous weakly monotonic kinetics, there is precisely one equilibrium in each nontrivial stoichiometric compatibility class, and it is positive.*

(iii) *If the kinetics is differentially monotonic then every positive equilibrium is nondegenerate. Moreover, every real eigenvalue associated with a positive equilibrium is negative.*

As in [18], it is understood that eigenvalues in the theorem statement are those associated with eigenvectors in the stoichiometric subspace. Similarly, when we say that a positive equilibrium is nondegenerate, we mean that, for the equilibrium, zero is not an eigenvalue corresponding to an eigenvector in the stoichiometric subspace. A stoichiometric compatibility class is nontrivial if it contains at least one positive composition.

Remark 2.9. Consider a (not necessarily nondegenerate) reaction network whose true chemistry SR Graph satisfies conditions (i) and (ii) of Theorem 2.1. With respect to the possibility of nondegenerate positive equilibria, Theorem 2.8 describes something of an all or nothing situation: If there is *some* differentially monotonic kinetics that gives rise to *even one* nondegenerate positive equilibrium, then the network itself is nondegenerate, in which case *every* positive equilibrium arising from *any* differentially monotonic kinetics is nondegenerate (and unique within its stoichiometric compatibility class).

Remark 2.10. Consider a nondegenerate reaction network that is not necessarily fully open. If its true-chemistry SR Graph satisfies the conditions of Theorem 2.6, then considerations in Section 7 will indicate that the network is strongly concordant. In this case, the dynamical properties of strongly concordant networks given in [18] accrue to the network at hand, and one can again deduce a theorem which, in the spirit of Theorem 2.8, makes statements about general properties of kinetic systems the network engenders, this time including those that derive from so-called “two-way monotonic kinetics.”

3 Reaction network theory preliminaries

This section is, for the most part, is a compendium of the definitions and infrastructure used in [18], repeated here for the reader’s convenience. Reference [18] has more in the way of discussion, and [10] has still more in the way of motivation. We begin with notation.

3.1 Notation

When I is a finite set (for example, a set of species or a set of reactions), we denote the vector space of real-valued functions with domain I by \mathbb{R}^I . If N is the number of elements in the set I , then \mathbb{R}^I is, in effect, a copy of the standard vector space \mathbb{R}^N , with the components of a vector $x \in \mathbb{R}^I$ indexed by the names of the members of I instead of the integers $1, 2, \dots, N$. For $x \in \mathbb{R}^I$

and $i \in I$, the symbol x_i denotes the value (component) of x corresponding to the element $i \in I$.

For example, if $\mathcal{S} = \{NO, O_2, NO_2\}$ is the set of species in a chemical system and if c_{NO}, c_{O_2} , and c_{NO_2} are the molar concentrations of the three species in a particular mixture state, then that state can be represented by a “composition vector” c in the vector space $\mathbb{R}^{\mathcal{S}}$. That is, c represents an assignment to each species of a number, the corresponding molar concentration. Readers who wish to do so can, in this case, simply regard c to be the 3-vector $[c_{NO}, c_{O_2}, c_{NO_2}]$, with the understanding that the arrangement of the three numbers in such an *ordered* array is superfluous to the mathematics at hand.

Vector representations in spaces such as \mathbb{R}^I rather than \mathbb{R}^N have advantages in consideration of graphs and networks, where one wants to avoid nomenclature that imparts an artificial numerical order to vertices or edges. See, for example, [3].

The subset of \mathbb{R}^I consisting of vectors having only positive (nonnegative) components is denoted \mathbb{R}_+^I ($\overline{\mathbb{R}_+^I}$). For each $x \in \mathbb{R}^I$ and for each $z \in \overline{\mathbb{R}_+^I}$, the symbol x^z denotes the real number defined by

$$x^z := \prod_{i \in I} (x_i)^{z_i},$$

where it is understood that $0^0 = 1$. For each $x, x' \in \mathbb{R}^I$, the symbol $x \circ x'$ denotes the vector of \mathbb{R}^I defined by

$$(x \circ x')_i := x_i x'_i, \quad \forall i \in I.$$

For each $i \in I$, we denote by ω_i the vector of \mathbb{R}^I such that $(\omega_i)_j = 1$ whenever $j = i$ and $(\omega_i)_j = 0$ whenever $j \neq i$.

The *standard basis* for \mathbb{R}^I is the set $\{\omega_i \in \mathbb{R}^I : i \in I\}$. Thus, for each $x \in \mathbb{R}^I$, we can write $x = \sum_{i \in I} x_i \omega_i$. The *standard scalar product* in \mathbb{R}^I is defined as follows: If x and x' are elements of \mathbb{R}^I , then

$$x \cdot x' = \sum_{i \in I} x_i x'_i.$$

The standard basis of \mathbb{R}^I is orthonormal with respect to the standard scalar product. It will be understood that \mathbb{R}^I carries the standard scalar product and the norm derived from the standard scalar product. It will also be understood that \mathbb{R}^I carries the corresponding norm topology.

If U is a linear subspace of \mathbb{R}^I , we denote by U^\perp the orthogonal complement of U in \mathbb{R}^I with respect to the standard scalar product.

By the *support* of $x \in \mathbb{R}^I$, denoted $\text{supp } x$, we mean the set of indices $i \in I$ for which x_i is different from zero. When ξ is a real number, the symbol $\text{sgn}(\xi)$ denotes the sign of ξ . When x is a vector of \mathbb{R}^I , $\text{sgn}(x)$ denotes the function with domain I defined by

$$(\text{sgn}(x))_i := \text{sgn } x_i, \quad \forall i \in I.$$

3.2 Some definitions

As indicated in Section 2, the objects in a reaction network that appear at the heads and tails of the reaction arrows are the *complexes* of the network. Thus, in network (3), the complexes are $2A, B, C, C + D$ and E . A reaction network can then be viewed as a directed graph, with complexes playing the role of the vertices and reaction arrows playing the role of the edges.



Remark 3.1. Let \mathcal{S} be the set of species in a network. In chemical reaction network theory, it is sometimes the custom to replace symbols for the standard basis of $\mathbb{R}^{\mathcal{S}}$ with the names of the species themselves. For example, in network (3), with $\mathcal{S} = \{A, B, C, D, E\}$, a vector such as $\omega_C + \omega_D \in \mathbb{R}^{\mathcal{S}}$ can instead be written as $C + D$, and $2\omega_A$ can be written as $2A$. In this way, $\mathbb{R}^{\mathcal{S}}$ can be identified with the vector space of formal linear combinations of the species. As a result, the complexes of a reaction network with species set \mathcal{S} can be identified with vectors in $\mathbb{R}^{\mathcal{S}}$.

Definition 3.2. A *chemical reaction network* consists of three finite sets:

1. a set \mathcal{S} of distinct *species* of the network;
2. a set $\mathcal{C} \subset \bar{\mathbb{R}}_+^{\mathcal{S}}$ of distinct *complexes* of the network;
3. a set $\mathcal{R} \subset \mathcal{C} \times \mathcal{C}$ of distinct *reactions*, with the following properties:

- (a) $(y, y) \notin \mathcal{R}$ for any $y \in \mathcal{C}$;
- (b) for each $y \in \mathcal{C}$ there exists $y' \in \mathcal{C}$ such that $(y, y') \in \mathcal{R}$ or such that $(y', y) \in \mathcal{R}$.

If (y, y') is a member of the reaction set \mathcal{R} , we say that y *reacts to* y' , and we write $y \rightarrow y'$ to indicate the reaction whereby complex y reacts to complex y' . The complex situated at the tail of a reaction arrow is the *reactant complex* of the corresponding reaction, and the complex situated at the head is the reaction's *product complex*.

For network (3), $\mathcal{S} = \{A, B, C, D, E\}$, $\mathcal{C} = \{2A, B, C, C + D, E\}$, and $\mathcal{R} = \{2A \rightarrow B, B \rightarrow 2A, B \rightarrow C, C \rightarrow 2A, C + D \rightarrow E, E \rightarrow C + D\}$. The diagram in (3) is an example of a *standard reaction diagram*: each complex in the network is displayed precisely once, and each reaction in the network is indicated by an arrow in the obvious way.

In the context of the present paper and its predecessor [18] the idea of *weak reversibility* plays an important role. The following definition provides some preparation.

Definition 3.3. A complex $y \in \mathcal{C}$ *ultimately reacts* to a complex $y' \in \mathcal{C}$ if any of the following conditions is satisfied:

1. $y \rightarrow y' \in \mathcal{R}$;
2. There is a sequence of complexes $y(1), y(2), \dots, y(k)$ such that

$$y \rightarrow y(1) \rightarrow y(2) \rightarrow \dots \rightarrow y(k) \rightarrow y'.$$

In network (3) the complex $2A$ ultimately reacts to the complex C , but the complex C does not ultimately react to the complex $C + D$.

Definition 3.4. A reaction network $\{\mathcal{S}, \mathcal{C}, \mathcal{R}\}$ is *reversible* if $y' \rightarrow y \in \mathcal{R}$ whenever $y \rightarrow y' \in \mathcal{R}$. The network is *weakly reversible* if for each $y, y' \in \mathcal{C}$, y' ultimately reacts to y whenever y ultimately reacts to y' .

Network (3) is weakly reversible but not reversible. On the other hand, every reversible network is also weakly reversible. A reaction network is weakly reversible if and only if in its standard reaction diagram every arrow resides in a directed arrow-cycle.

Definition 3.5. The *reaction vectors* for a reaction network $\{\mathcal{S}, \mathcal{C}, \mathcal{R}\}$ are the members of the set

$$\{y' - y \in \mathbb{R}^{\mathcal{S}} : y \rightarrow y' \in \mathcal{R}\}.$$

The *rank* of a reaction network is the rank of its set of reaction vectors.

For network (3) the reaction vector corresponding to the reaction $2A \rightarrow B$ is $B - 2A$. The reaction vector corresponding to the reaction $C + D \rightarrow E$ is $E - C - D$.

Definition 3.6. The *stoichiometric subspace* S of a reaction network $\{\mathcal{S}, \mathcal{C}, \mathcal{R}\}$ is the linear subspace of $\mathbb{R}^{\mathcal{S}}$ defined by

$$S := \text{span} \{y' - y \in \mathbb{R}^{\mathcal{S}} : y \rightarrow y' \in \mathcal{R}\}. \quad (4)$$

The dimension of the stoichiometric subspace is identical to the network's rank. The stoichiometric subspace is a proper linear subspace of $\mathbb{R}^{\mathcal{S}}$ whenever the network is *conservative*:

Definition 3.7. A reaction network $\{\mathcal{S}, \mathcal{C}, \mathcal{R}\}$ is *conservative* if the orthogonal complement S^\perp of the stoichiometric subspace S contains a strictly positive member of $\mathbb{R}^{\mathcal{S}}$:

$$S^\perp \cap \mathbb{R}_+^{\mathcal{S}} \neq \emptyset.$$

Network (3) is conservative: The strictly positive vector $(A + 2B + 2C + D + 3E) \in \mathbb{R}_+^{\mathcal{S}}$ is orthogonal to each of the reaction vectors of (3).

For a reaction network $\{\mathcal{S}, \mathcal{C}, \mathcal{R}\}$ a mixture state is generally represented by a *composition vector* $c \in \overline{\mathbb{R}}_+^{\mathcal{S}}$, where, for each $s \in \mathcal{S}$, we understand c_s to be the molar concentration of s . By a *positive composition* we mean a strictly positive composition — that is, a composition in $\mathbb{R}_+^{\mathcal{S}}$.

Definition 3.8. A *kinetics* \mathcal{K} for a reaction network $\{\mathcal{S}, \mathcal{C}, \mathcal{R}\}$ is an assignment to each reaction $y \rightarrow y' \in \mathcal{R}$ of a *rate function* $\mathcal{K}_{y \rightarrow y'} : \overline{\mathbb{R}}_+^{\mathcal{S}} \rightarrow \overline{\mathbb{R}}_+$ such that

$$\mathcal{K}_{y \rightarrow y'}(c) > 0 \text{ if and only if } \text{supp } y \subset \text{supp } c.$$

Definition 3.9. A *kinetic system* $\{\mathcal{S}, \mathcal{C}, \mathcal{R}, \mathcal{K}\}$ is a reaction network $\{\mathcal{S}, \mathcal{C}, \mathcal{R}\}$ taken with a kinetics \mathcal{K} for the network.

Many of the dynamical consequences of network concordance require that the kinetics be *weakly monotonic* or *differentiably monotonic*. Both are formally defined below:

Definition 3.10. A kinetics \mathcal{K} for reaction network $\{\mathcal{S}, \mathcal{C}, \mathcal{R}\}$ is *weakly monotonic* if, for each pair of compositions c^* and c^{**} , the following implications hold for each reaction $y \rightarrow y' \in \mathcal{R}$ such that $\text{supp } y \subset \text{supp } c^*$ and $\text{supp } y \subset \text{supp } c^{**}$:

- (i) $\mathcal{K}_{y \rightarrow y'}(c^{**}) > \mathcal{K}_{y \rightarrow y'}(c^*) \Rightarrow$ there is a species $s \in \text{supp } y$ with $c_s^{**} > c_s^*$.
- (ii) $\mathcal{K}_{y \rightarrow y'}(c^{**}) = \mathcal{K}_{y \rightarrow y'}(c^*) \Rightarrow c_s^{**} = c_s^*$ for all $s \in \text{supp } y$ or else there are species $s, s' \in \text{supp } y$ with $c_s^{**} > c_s^*$ and $c_{s'}^{**} < c_{s'}^*$.

We say that the kinetic system $\{\mathcal{S}, \mathcal{C}, \mathcal{R}, \mathcal{K}\}$ is weakly monotonic when its kinetics \mathcal{K} is weakly monotonic.

Definition 3.11. A kinetics \mathcal{K} for a reaction network $\{\mathcal{S}, \mathcal{C}, \mathcal{R}\}$ is *differentiably monotonic* at $c^* \in \mathbb{R}_+^{\mathcal{S}}$ if, for every reaction $y \rightarrow y' \in \mathcal{R}$, $\mathcal{K}_{y \rightarrow y'}(\cdot)$ is differentiable at c^* and, moreover, for each species $s \in \mathcal{S}$,

$$\frac{\partial \mathcal{K}_{y \rightarrow y'}}{\partial c_s}(c^*) \geq 0, \tag{5}$$

with inequality holding if and only if $s \in \text{supp } y$. A *differentiably monotonic kinetics* is one that is differentiably monotonic at every positive composition.

When a kinetics \mathcal{K} for a reaction network $\{\mathcal{S}, \mathcal{C}, \mathcal{R}\}$ is differentiably monotonic at $c^* \in \mathbb{R}_+^{\mathcal{S}}$, we denote by the symbol $\nabla \mathcal{K}_{y \rightarrow y'}(c^*)$ the member of $\mathbb{R}^{\mathcal{S}}$ defined by

$$\nabla \mathcal{K}_{y \rightarrow y'}(c^*) := \sum_{s \in \mathcal{S}} \frac{\partial \mathcal{K}_{y \rightarrow y'}}{\partial c_s}(c^*) s.$$

Note that every mass action kinetics is both weakly monotonic and differentiably monotonic. Recall that a *mass action kinetics* is a kinetics in which the rate function corresponding to each reaction $y \rightarrow y'$ takes the form $\mathcal{K}_{y \rightarrow y'}(c) = k_{y \rightarrow y'} c^y$, $\forall c \in \overline{\mathbb{R}}_+^{\mathcal{S}}$, where $k_{y \rightarrow y'}$ is a positive *rate constant* for the reaction $y \rightarrow y'$.

Definition 3.12. The *species formation rate function* for a kinetic system $\{\mathcal{S}, \mathcal{C}, \mathcal{R}, \mathcal{K}\}$ with stoichiometric subspace S is the map $f : \overline{\mathbb{R}}_+^{\mathcal{S}} \rightarrow S$ defined by

$$f(c) = \sum_{y \rightarrow y' \in \mathcal{R}} \mathcal{K}_{y \rightarrow y'}(c)(y' - y). \quad (6)$$

Definition 3.13. The *differential equation* for a kinetic system with species formation rate function $f(\cdot)$ is given by

$$\dot{c} = f(c). \quad (7)$$

From equations (4), (6), and (7), it follows that, for a kinetic system $\{\mathcal{S}, \mathcal{C}, \mathcal{R}, \mathcal{K}\}$, the vector \dot{c} will invariably lie in the stoichiometric subspace S for the network $\{\mathcal{S}, \mathcal{C}, \mathcal{R}\}$. Thus, two compositions $c \in \overline{\mathbb{R}}_+^{\mathcal{S}}$ and $c' \in \overline{\mathbb{R}}_+^{\mathcal{S}}$ can lie along the same solution of (7) only if their difference $c' - c$ lies in S . This motivates the following definition:

Definition 3.14. Let $\{\mathcal{S}, \mathcal{C}, \mathcal{R}\}$ be a reaction network with stoichiometric subspace S . Two compositions c and c' in $\overline{\mathbb{R}}_+^{\mathcal{S}}$ are *stoichiometrically compatible* if $c' - c$ lies in S .

For a network $\{\mathcal{S}, \mathcal{C}, \mathcal{R}\}$, the stoichiometric compatibility relation serves to partition $\overline{\mathbb{R}}_+^{\mathcal{S}}$ into equivalence classes called the *stoichiometric compatibility classes* for the network. Thus, the stoichiometric compatibility class containing an arbitrary composition c , denoted $(c + S) \cap \overline{\mathbb{R}}_+^{\mathcal{S}}$, is given by

$$(c + S) \cap \overline{\mathbb{R}}_+^{\mathcal{S}} = \{c' \in \overline{\mathbb{R}}_+^{\mathcal{S}} : c' - c \in S\}. \quad (8)$$

The notation is intended to suggest that $(c + S) \cap \overline{\mathbb{R}}_+^{\mathcal{S}}$ is the intersection of $\overline{\mathbb{R}}_+^{\mathcal{S}}$ with the parallel of S containing c . A stoichiometric compatibility class is *nontrivial* if it contains at least one (strictly) positive composition.

Definition 3.15. An *equilibrium* of a kinetic system $\{\mathcal{S}, \mathcal{C}, \mathcal{R}, \mathcal{K}\}$ is a composition $c \in \overline{\mathbb{R}}_+^{\mathcal{S}}$ for which $f(c) = 0$. A *positive equilibrium* is an equilibrium that lies in $\mathbb{R}_+^{\mathcal{S}}$.

Because compositions along solutions of (7) are stoichiometrically compatible, one is typically interested in changes in values of the species formation rate function that result from changes in composition that are stoichiometrically compatible. In particular, if $f(c^*)$ is the value of the species formation rate function at composition c^* , then one might be interested in the value of $f(c)$ for a composition c very close to c^* and stoichiometrically compatible with it. Thus, for a kinetic system $\{\mathcal{S}, \mathcal{C}, \mathcal{R}, \mathcal{K}\}$ with stoichiometric subspace S , with smooth reaction rate functions, and with species formation rate function $f: \overline{\mathbb{R}}_+^{\mathcal{S}} \rightarrow S$, we will want to work with the derivative $df(c^*): S \rightarrow S$, defined by

$$df(c^*)\sigma = \left. \frac{df(c^* + \theta\sigma)}{d\theta} \right|_{\theta=0}, \quad \forall \sigma \in S. \quad (9)$$

We say that $c^* \in \mathbb{R}_+^{\mathcal{S}}$ is a *nondegenerate equilibrium* if c^* is an equilibrium and if, moreover, $df(c^*)$ is nonsingular. An *eigenvalue associated with a positive equilibrium* $c^* \in \mathbb{R}_+^{\mathcal{S}}$ is an eigenvalue of the derivative $df(c^*)$.

4 Concordant reaction networks

Here we recall the definition of reaction network concordance [18]. We consider a reaction network $\{\mathcal{S}, \mathcal{C}, \mathcal{R}\}$ with stoichiometric subspace $S \subset \mathbb{R}^{\mathcal{S}}$, and we let $L: \mathbb{R}^{\mathcal{R}} \rightarrow S$ be the linear map defined by

$$L\alpha = \sum_{y \rightarrow y' \in \mathcal{R}} \alpha_{y \rightarrow y'} (y' - y). \quad (10)$$

Definition 4.1. The reaction network $\{\mathcal{S}, \mathcal{C}, \mathcal{R}\}$ is *concordant* if there do not exist an $\alpha \in \ker L$ and a nonzero $\sigma \in S$ having the following properties:

(i) For each $y \rightarrow y'$ such that $\alpha_{y \rightarrow y'} \neq 0$, $\text{supp } y$ contains a species s for which $\text{sgn } \sigma_s = \text{sgn } \alpha_{y \rightarrow y'}$.

(ii) For each $y \rightarrow y'$ such that $\alpha_{y \rightarrow y'} = 0$, $\sigma_s = 0$ for all $s \in \text{supp } y$ or else $\text{supp } y$ contains species s and s' for which $\text{sgn } \sigma_s = -\text{sgn } \sigma_{s'}$, both not zero.

A network that is not concordant is *discordant*.

Note that for a fully open network with species set \mathcal{S} the stoichiometric subspace coincides with $\mathbb{R}^{\mathcal{S}}$. The following lemma will prove useful later on:

Lemma 4.2. *If a fully open network is discordant, it is always possible to choose from each reversible pair of non-degradation reactions at least one (and sometimes both) of the reactions for removal such that the resulting fully open subnetwork is again discordant.*

Proof. Suppose that a fully open network $\{\mathcal{S}, \mathcal{C}, \mathcal{R}\}$ is discordant. Then there are $\alpha \in \ker L$ and nonzero σ that together satisfy conditions (i) and (ii) in Definition 4.1. In particular, we have

$$\sum_{y \rightarrow y' \in \mathcal{R}} \alpha_{y \rightarrow y'}(y' - y) = 0. \quad (11)$$

Let $\bar{y} \rightleftharpoons \bar{y}'$ be a pair of reversible non-degradation reactions in \mathcal{R} , and suppose that $\alpha_{\bar{y} \rightarrow \bar{y}'} \neq \alpha_{\bar{y}' \rightarrow \bar{y}}$ with the complexes labeled such that $|\alpha_{\bar{y} \rightarrow \bar{y}'}| > |\alpha_{\bar{y}' \rightarrow \bar{y}}|$. In this case, let $\mathcal{R}^\dagger := \mathcal{R} \setminus \{\bar{y}' \rightarrow \bar{y}\}$, let $\alpha_{\bar{y} \rightarrow \bar{y}'}^\dagger := \alpha_{\bar{y} \rightarrow \bar{y}'} - \alpha_{\bar{y}' \rightarrow \bar{y}}$, and, for all other $y \rightarrow y'$ in \mathcal{R}^\dagger , let $\alpha_{y \rightarrow y'}^\dagger := \alpha_{y \rightarrow y'}$. From (11) it follows easily that

$$\sum_{y \rightarrow y' \in \mathcal{R}^\dagger} \alpha_{y \rightarrow y'}^\dagger(y' - y) = 0. \quad (12)$$

If, on the other hand, $\alpha_{\bar{y} \rightarrow \bar{y}'} = \alpha_{\bar{y}' \rightarrow \bar{y}}$, then we can choose $\mathcal{R}^\dagger := \mathcal{R} \setminus \{\bar{y}' \rightleftharpoons \bar{y}\}$, and, for all $y \rightarrow y'$ in \mathcal{R}^\dagger , we can let $\alpha_{y \rightarrow y'}^\dagger := \alpha_{y \rightarrow y'}$. In this case, (12) will again obtain.

In either case, it is easy to see that α^\dagger , taken with the original σ , suffices to establish the discordance of the subnetwork associated with the reaction set \mathcal{R}^\dagger . \square

Remark 4.3. In effect, Lemma 4.2 tells us that every fully open discordant network with reversible non-degradation reactions has a discordant fully open subnetwork in which no non-degradation reaction is reversible. Note that, apart from minor changes in labels within the reaction nodes (i.e., replacement of $y \rightleftharpoons y'$ by $y \rightarrow y'$) the Species-Reaction Graph derived from the indicated discordant subnetwork is a subgraph of the Species-Reaction Graph drawn for the original network. As we explain at the beginning of Section 5, that subgraph will satisfy the conditions of Theorem 2.1 and its corollary if the parent Species-Reaction Graph does. These observations will help us simplify certain arguments that are otherwise complicated by the presence of reversible reactions.

5 Proof of Theorem 2.1

The proof will be by contradiction. With this in mind, we assume hereafter the true-chemistry Species-Reaction Graph (SR Graph) for the fully open network under consideration has both attributes of the theorem statement and that, contrary to the assertion of the theorem, the fully open network is discordant.

In this case, Lemma 4.2 tells us that, when the true chemistry has reversible reaction pairs, then each such pair can be replaced by a certain irreversible reaction of the pair (or else removed completely) such that the resulting fully open network is again discordant. The SR Graph for the altered (totally irreversible) true chemistry might have fewer cycles than in the original SR Graph (but never more) because of removal of reversible reaction pairs. Similarly, there might be fewer *orientable* cycles (but never more) than in the original SR Graph as a result of replacement of reversible reaction pairs by single irreversible reactions. Moreover, there might be fewer critical subgraphs (but never more) than in the original SR Graph because of a loss of orientable cycles or because more cycles have acquired compulsory orientations. (Cycles that were even in the original SR Graph and persist in the new SR Graph remain even.) For all of these reasons, *the SR Graph for the totally irreversible subnetwork of the original “true” chemical reaction network will, like the SR Graph for the original network, satisfy the requirements of Theorem 2.1.*

This is to say that there is no loss of generality in assuming, for the purposes of contradiction, that there is a “true” chemical reaction network, containing no reversible reactions, for which the SR Graph satisfies both requirements of Theorem 2.1 but for which the fully open extension is discordant.

Hereafter in the proof of Theorem 2.1, then, *we assume that all reactions in the “true” chemistry are irreversible, that the corresponding SR Graph satisfies both conditions of Theorem 2.1, and that, contrary to what the theorem asserts, the fully open extension of the true chemistry is discordant.*

Thus there exist fixed $\alpha \in \ker L$ and nonzero $\sigma \in \mathbb{R}^{\mathcal{S}}$ satisfying the requirements of Definition 4.1. (Recall that the stoichiometric subspace for a fully open network is $\mathbb{R}^{\mathcal{S}}$.) *It will be understood throughout the proof that all references to α and σ are relative to this fixed pair, so chosen.*

It will be helpful to divide the proof into subsections:

5.1 Preliminaries

We associate a sign with each species in the following way: A species $s \in \mathcal{S}$ is *positive*, *negative*, or *zero* according to whether σ_s is positive, negative, or zero. By a *signed species* we mean one that is either positive or negative. Similarly, a reaction $y \rightarrow y' \in \mathcal{R}$ is *positive*, *negative*, or *zero* according to whether $\alpha_{y \rightarrow y'}$ is positive, negative, or zero. A *signed reaction* is one that is either positive or negative.

Remark 5.1. Note in particular, that for any “degradation reaction” of the kind $s \rightarrow 0$, Definition 4.1 requires that $\text{sgn } \alpha_{s \rightarrow 0} = \text{sgn } \sigma_s$, so $\text{sgn } s \rightarrow 0 = \text{sgn } s$ for every $s \in \mathcal{S}$. (A similar situation obtains for any reaction of the form $ns \rightarrow y$, where n is a positive number.) For any “synthesis reaction” $0 \rightarrow s$, Definition 4.1 requires that $\alpha_{0 \rightarrow s} = 0$, so such reactions are unsigned.

5.2 The sign-causality graph and causal units

Hereafter we denote by \mathcal{R}^* the set of all reactions not of the form $s \rightarrow 0$, $s \in \mathcal{S}$. That is, \mathcal{R}^* is the set of reactions that are not degradation reactions. Because α is a member of $\ker L$ we can write

$$\sum_{y \rightarrow y' \in \mathcal{R}^*} \alpha_{y \rightarrow y'} (y' - y) - \sum_{s \in \mathcal{S}} \alpha_{s \rightarrow 0} s = 0. \quad (13)$$

Thus, for any particular choice of species $s \in \mathcal{S}$, we have

$$\sum_{y \rightarrow y' \in \mathcal{R}^*} \alpha_{y \rightarrow y'} (y'_s - y_s) = \alpha_{s \rightarrow 0}. \quad (14)$$

Now *suppose that in (14), the species s is positive*. From (14) and Remark 5.1 we have

$$\sum_{y \rightarrow y' \in \mathcal{R}^*} \alpha_{y \rightarrow y'} (y'_s - y_s) > 0, \quad (15)$$

in which case at least one term on the left must be positive. (At least one term on the left is “causal” for the inequality.⁶) Terms of this kind can arise in precisely two ways:

(i) There is a *positive* reaction $y \rightarrow y'$ (i.e., $\alpha_{y \rightarrow y'}$ is positive) with $s \in \text{supp } y'$ (so that $y'_s > 0, y_s = 0$). Recall, however, that for $\alpha_{y \rightarrow y'}$ to be positive, the

⁶When we say that X is causal for the outcome Y, we mean to suggest that X abets Y, not necessarily that X, by itself, determines the outcome Y.

conditions of Definition 4.1 require that there be a *positive* species s' in $\text{supp } y$.

In this case, reaction $y \rightarrow y'$ is “causal” for the sign of species s , while species s' is “causal” for the sign of reaction $y \rightarrow y'$. With this in mind, we write

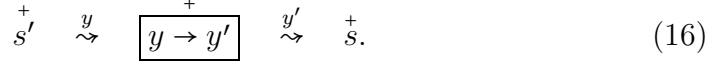

The signs above the species and the reactions indicate their respective signs. The complex labels above the “causal” arrows (\rightsquigarrow) indicate the complex in whose support the adjacent species resides.

(ii) There is a *negative* reaction $y \rightarrow y'$ (i.e., $\alpha_{y \rightarrow y'}$ is negative) with $s \in \text{supp } y$ (so that $y_s > 0, y'_s = 0$). But for $\alpha_{y \rightarrow y'}$ to be negative, the conditions of Definition 4.1 require that there be a *negative* species s' in $\text{supp } y$. As in case (i), reaction $y \rightarrow y'$ is causal for the sign of species s , while species s' is causal for the sign of reaction $y \rightarrow y'$. This time we write

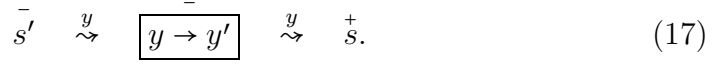

On the other hand, *suppose that in (14), the species s is negative*. From (14) and Remark 5.1 we have

$$\sum_{y \rightarrow y' \in \mathcal{R}^*} \alpha_{y \rightarrow y'} (y'_s - y_s) < 0, \quad (18)$$

in which case at least one term on the left must be negative. (At least one term on the left is causal for the inequality.) Here again, terms of this kind can arise in precisely two ways:

(i)' There is a *negative* reaction $y \rightarrow y'$ (i.e., $\alpha_{y \rightarrow y'}$ is negative) with $s \in \text{supp } y'$ (so that $y'_s > 0, y_s = 0$). For $\alpha_{y \rightarrow y'}$ to be negative, the conditions of Definition 4.1 require that there be a *negative* species s' in $\text{supp } y$. Here we write

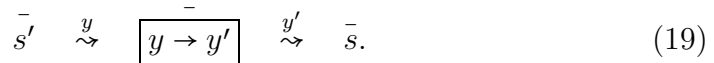

(ii)' There is a *positive* reaction $y \rightarrow y'$ (i.e., $\alpha_{y \rightarrow y'}$ is positive) with $s \in \text{supp } y$ (so that $y_s > 0, y'_s = 0$). For $\alpha_{y \rightarrow y'}$ to be positive, the conditions of Definition 4.1 require that there be a *positive* species s' in $\text{supp } y$. We write

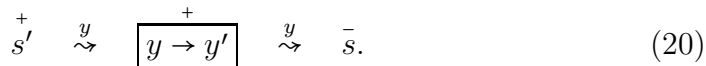

The diagrams drawn in (16), (17), (19) and (20) can be viewed as edge-pairs in a bipartite directed graph:

The *sign-causality graph*, drawn for the network (relative to the α , σ pair under consideration) is constructed according to the following prescription: The vertices are the signed species and signed (non-degradation) reactions. An edge \rightsquigarrow is drawn from a signed species s' to a signed reaction $y \rightarrow y'$ whenever s' is contained in $\text{supp } y$ and the two signs agree; the edge is then labeled with the complex y . An edge \rightsquigarrow is drawn from a signed reaction $y \rightarrow y'$ to a signed species s in either of the following situations: (i) s is contained in $\text{supp } y'$ and the sign of s agrees with the sign of the reaction; in this case the edge carries the label y' or (ii) s is contained in $\text{supp } y$ and the sign of s disagrees with the sign of the reaction; in this case the edge carries the label y . It is understood that the signed species and the signed reactions are labeled by their corresponding signs.

By a *causal unit* we mean a directed two-edge subgraph of the sign-causality graph of the kind $s' \rightsquigarrow R \rightsquigarrow s$, where R denotes a reaction. (We will often designate a reaction by the symbol R when there is no need to indicate the reactant and product complexes.) The species s' is the *initiator* of the causal unit $s' \rightsquigarrow R \rightsquigarrow s$, while s is its *terminator*. It is not difficult to see that the initiator and terminator of a causal unit must be *distinct* species.⁷

Causal units are of the four varieties shown in (16), (17), (19) and (20). Of these, (16) and (19) carry distinct complex labels on the two edges. On the other hand, (17) and (20) carry identical labels on the edges. By a *c-pair causal unit* we mean a causal unit of the second kind. (As with the Species-Reaction Graph, the term is meant to be mnemonic for *complex pair*.)

Remark 5.2. It is important to note that a c-pair causal unit results in a *change* of sign as the edges are traversed from the initiator species to the terminator species. Otherwise, a causal unit is characterized by *retention* of the sign.

Remark 5.3. It should be clear that, apart from the direction \rightsquigarrow imparted to its edges, the sign-causality graph corresponding to α and σ can be identified

⁷Recall that, by supposition, a species can appear on only one side of a reaction.

with a subgraph of the undirected Species-Reaction Graph (which we will sometimes refer to as the sign-causality graph’s “counterpart” in the Species-Reaction Graph). Moreover, every fixed-direction edge-pair in the SR Graph has direction consistent with that imparted by the \rightsquigarrow -relation (because each proceeds from a reactant species to an irreversible reaction to a product species).

5.3 The sign-causality graph must contain a directed cycle, and all of its directed cycles are even.

By supposition σ is not zero, so there is at least one signed species, say s_1 . From the discussion in Section 5.2 it is clear that s_1 is the terminator of a causal unit $s_2 \rightsquigarrow R_2 \rightsquigarrow s_1$, where s_2 is distinct from the initiator s_1 . Because s_2 is also signed, it too must be the terminator of a causal unit $s_3 \rightsquigarrow R_3 \rightsquigarrow s_2$, where the signed species s_3 is distinct from s_2 . Continuing in this way, we can see that there is a directed sequence of the form

$$\dots \rightsquigarrow s_n \rightsquigarrow R_n \rightsquigarrow s_{n-1} \rightsquigarrow R_{n-1} \dots \rightsquigarrow s_3 \rightsquigarrow R_3 \rightsquigarrow s_2 \rightsquigarrow R_2 \rightsquigarrow s_1, \quad (21)$$

with $s_i \neq s_{i+1}$.

Because the number of species is finite, two non-consecutive species in the sequence must in fact coincide, which is to say that *the sign-causality graph must contain a directed cycle*. Moreover, it is easy to see that each vertex in the sign-causality graph resides in a cycle or else there is a cycle \rightsquigarrow -upstream from it.

With this in mind, we record here some vocabulary that will be useful in the next section: A *source* is a strong component of the sign-causality graph whose vertices have no incoming edges originating at vertices outside that strong component. Clearly, every component of the sign-causality graph contains a source, and every vertex in a source resides in a directed cycle.

As with the SR Graph, we say that a (not necessarily directed) cycle in the sign-causality graph is *even* if it contains an even number of c-pairs.

Lemma 5.4. *A (not necessarily directed) cycle in the sign-causality graph that is the union of causal units is even. In particular, every directed cycle in the sign-causality graph is even.*

Proof. If we traverse the cycle beginning at a species s^0 and count the number of species-sign changes when we have returned to s^0 , that number clearly

must be even. But, if the cycle is the union of causal units, the number of sign changes is identical to the number of c-pair causal units the cycle contains (Remark 5.2). Clearly, every directed cycle in the sign-causality graph is the union of causal units. \square

Because a directed cycle in the sign-causality graph is even, its (orientable) cycle counterpart in the undirected Species-Reaction Graph (Remark 5.3) will also have an even number of c-pairs. Because the sign-causality graph must contain a source, which in turn must contain a directed cycle, we now know that *a reaction network is concordant if its Species-Reaction Graph contains no orientable even cycles.*

Remark 5.5. In fact, a source in the sign-causality graph, when viewed in the SR Graph, must be a critical subgraph. That this is so follows from the fact that a source is a strong component of the sign-causality graph and therefore is the union of \rightsquigarrow -directed cycles. These even cycles, viewed in the SR Graph, have a consistent orientation, the orientation conferred by the directed-cycle \rightsquigarrow -orientation in the sign-causality graph, which in turn is consistent with any fixed-direction edge-pairs the SR Graph might contain.

In the next section we begin to consider what happens when the Species-Reaction Graph does contain at least one orientable even cycle (and therefore at least one critical subgraph). We will want to show that if the fully open network under consideration satisfies the hypothesis of Theorem 2.1 then the very existence of a source in the putative sign-causality graph becomes impossible.⁸

5.4 Inequalities associated with a source; stoichiometric coefficients associated with edges in the sign-causality graph

Consider a source in the sign-causality graph having $\mathcal{S}_0 \subset \mathcal{S}$ as its set of species nodes and $\mathcal{R}_0 \subset \mathcal{R}^*$ as its set of reaction nodes. If s is a *positive* species in the source, then (15) can be written

⁸As a matter of vocabulary, a strong component of a directed graph — in particular a source — is, formally, a set of vertices in the graph, but here, less formally, we will also associate the source with the subgraph of the sign-causality graph obtained by joining the vertices of the source with directed edges inherited from the parent graph.

$$\sum_{y \rightarrow y' \in \mathcal{R}_0} \alpha_{y \rightarrow y'}(y'_s - y_s) + \sum_{y \rightarrow y' \in \mathcal{R}^* \setminus \mathcal{R}_0} \alpha_{y \rightarrow y'}(y'_s - y_s) > 0. \quad (22)$$

Now suppose that a term in the second sum on the left, corresponding to reaction $\bar{y} \rightarrow \bar{y}'$, is not zero. Because $\bar{y} \rightarrow \bar{y}'$ is not a vertex of the source, any edge of the sign-causality graph that connects species s to reaction $\bar{y} \rightarrow \bar{y}'$ must point *away* from s . Thus, the reaction $\bar{y} \rightarrow \bar{y}'$ cannot be causal for the positive sign of species s , so the term

$$\alpha_{\bar{y} \rightarrow \bar{y}'}(\bar{y}'_s - \bar{y}_s)$$

must be negative. This implies that (22) can obtain only if we have

$$\sum_{y \rightarrow y' \in \mathcal{R}_0} \alpha_{y \rightarrow y'}(y'_s - y_s) > 0. \quad (23)$$

When s is a *negative* species in the source, we can reason similarly to write

$$\sum_{y \rightarrow y' \in \mathcal{R}_0} \alpha_{y \rightarrow y'}(y'_s - y_s) < 0. \quad (24)$$

Remark 5.6. Note that, for a particular $s \in \mathcal{S}_0$ a nonzero term in (23) or (24) might not correspond to any edge of the sign-causality graph (as when, for a particular reaction $y \rightarrow y'$, s is a member of $\text{supp } y'$ and disagrees in sign with $\alpha_{y \rightarrow y'}$). If s is a positive species, then the term in question must be negative, and hence it can be removed from (23) without changing the sense of that inequality. Similarly, if s is a negative species, the term in question is positive and can be removed from (24) without changing the inequality's sense. *In what follows below, we shall assume that such removals have been made, so that every term in (23) or (24) corresponds to an edge in the sign-causality graph.*

Recall that a directed edge of the sign-causality graph from a species s to a reaction $y \rightarrow y'$ is always of the form

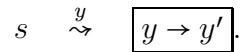

That is, the edge-label of such a species-to-reaction edge is invariably the reactant complex, y . Note that species s has a positive stoichiometric coefficient, y_s , in that complex. On the other hand, reaction-to-species edges of the sign-causality graph are of two kinds:

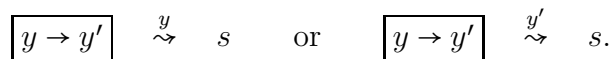

In either case, the species s has a positive stoichiometric coefficient (either y_s or y'_s) in the edge-labeling complex.

Hereafter, for a species-to-reaction edge $s \rightsquigarrow R$ of the sign-causality graph we denote by $e_{s \rightsquigarrow R}$ the (positive) stoichiometric coefficient of species s in the corresponding edge-labeling complex. For a reaction-to-species edge $R \rightsquigarrow s$ we denote by $f_{R \rightsquigarrow s}$ the (positive) stoichiometric coefficient of species s in its edge-labeling complex.

For the sign-causality graph source under consideration, we will in fact need a small amount of additional notation: For each species $s \in \mathcal{S}_0$ we denote by $\mathcal{R}_0 \rightsquigarrow s$ the set of all edges of the source that are incoming to s and by $s \rightsquigarrow \mathcal{R}_0$ the set of all edges of the source that are outgoing from s . In light of Remark 5.6 and in view of notation we now have available, some analysis will indicate that the inequalities given by (23) and (24) can be written as a single system:

$$\boxed{\sum_{\mathcal{R}_0 \rightsquigarrow s} f_{R \rightsquigarrow s} |\alpha_R| - \sum_{s \rightsquigarrow \mathcal{R}_0} e_{s \rightsquigarrow R} |\alpha_R| > 0, \quad \forall s \in \mathcal{S}_0.} \quad (25)$$

Our aim will be to show that when the conditions of Theorem 2.1 obtain, the inequality system (25) cannot be satisfied. The following remark will play an important role.

Remark 5.7. Consider a source in the sign-causality graph, and suppose that

$$s_1 \rightsquigarrow R_1 \rightsquigarrow s_2 \rightsquigarrow R_2 \cdots \rightsquigarrow s_n \rightsquigarrow R_n \rightsquigarrow s_1 \quad (26)$$

is one of its \rightsquigarrow -directed (and therefore even) cycles. Note that the \rightsquigarrow -orientation of the cycle also provides an orientation of the cycle's counterpart in the Species-Reaction Graph, for it is consistent with directions of the fixed-direction edge-pairs in the SR Graph. (Remark 5.3)

Thus, when condition (i) of Theorem 2.1 is satisfied, the stoichiometric coefficients of the directed cycle (26) must satisfy the condition

$$\frac{f_{R_1 \rightsquigarrow s_2} f_{R_2 \rightsquigarrow R_3} \cdots f_{R_n \rightsquigarrow s_1}}{e_{s_1 \rightsquigarrow R_1} e_{s_2 \rightsquigarrow R_2} \cdots e_{s_n \rightsquigarrow R_n}} \leq 1. \quad (27)$$

5.5 The decomposition of a source into its blocks; the block-tree of a source

Here we draw on graph theory vocabulary that is more-or-less standard [4].⁹ A *separation* of a connected graph is a decomposition of the graph into two edge-disjoint connected subgraphs, each having at least one edge, such that the two subgraphs have just one vertex in common. If a connected graph admits a separation (in which case it is *separable*), then the common vertex of the separation is called a *separating vertex* of the graph. A graph is *nonseparable* if it is connected and has no separating vertices. A maximal nonseparable subgraph of a graph is called a *block* of the graph. In rough terms, a connected graph is made up of its blocks, pinned together at the graph's separating vertices.

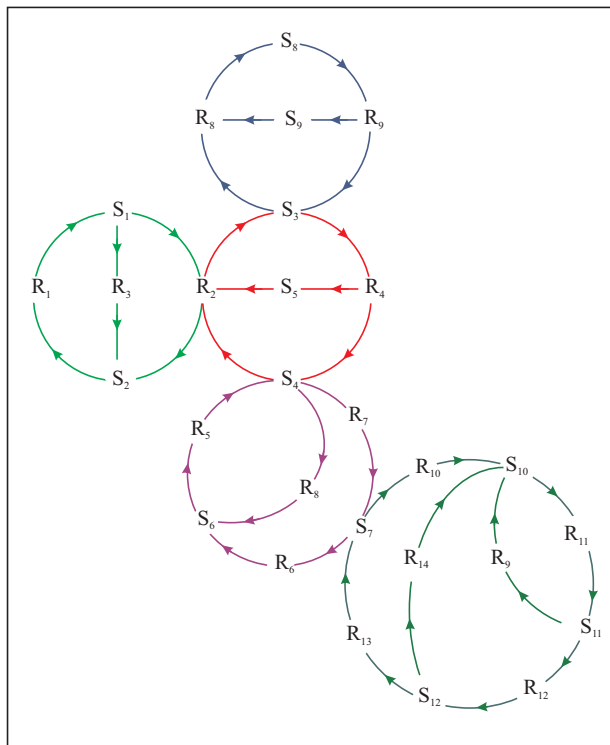

Figure 2: A hypothetical source with five blocks

⁹Our focus is on bipartite graphs, so in the discussion of terminology it will be understood that no vertex is adjacent to itself via a self-loop edge.

A source in the sign-causality graph can be decomposed into its blocks, which we call *source-blocks*. Because a source is strongly connected, each of its blocks is strongly connected (and non-separable). To illustrate some of these ideas we show in Figure 2 a hypothetical source with five blocks. (Although they are inconsequential to the block decomposition, the arrows in the figure are meant to connote the \rightsquigarrow -relation.) The separating vertices in the figure are R_2, S_3, S_4 , and S_7 . An example of a block is the subgraph having vertices $\{S_1, S_2, R_1, R_2, R_3\}$ and edges $\{S_1 \rightsquigarrow R_2, R_2 \rightsquigarrow S_2, S_2 \rightsquigarrow R_1, R_1 \rightsquigarrow S_1, S_1 \rightsquigarrow R_3, R_3 \rightsquigarrow S_2\}$.

The *block-tree* of a connected graph depicts the way in which the various blocks of the graph are joined at its separating vertices. More precisely, the block-tree [4] of a connected graph is a bipartite graph whose vertices are of two kinds: symbols for the graph's blocks and symbols for the graph's separating vertices. In Figure 3 we show the block-tree for the hypothetical source depicted in Figure 2. For reasons that will be made clear later on, we have denoted the five blocks in the block-tree by the symbols $RB1, SB1, SB2, RB2$, and $RB3$. (We note that Figures 2 and 3 are somewhat unrepresentative, for it might happen that three or more source-blocks are adjacent to the same separating vertex.)

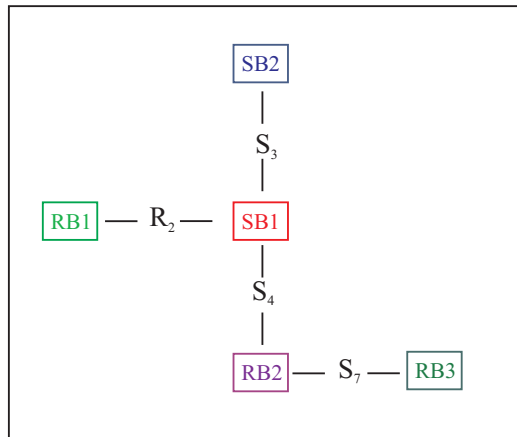

Figure 3: The block-tree for Figure 2

A block is an *end block* if it contains no more than one separating vertex of the original graph. In this case, the block's symbol is a *leaf* of the block-

tree graph. The end-blocks (leaves) in our example are those represented by $RB1$, $SB2$, and $RB3$.

5.6 Properties of source-blocks

Our aim in this subsection is to show that when condition (ii) of Theorem 2.1 is satisfied, the internal structure of source-blocks must have a certain degree of simplicity. Condition (ii) will exert itself primarily through the following proposition, which is proved in Appendix A.

Proposition 5.8. *Suppose that, for the reaction network under consideration, the Species-Reaction Graph satisfies condition (ii) of Theorem 2.1. Then, in any source-block of the sign-causality graph, at most one of the following can obtain:*

(i) *There is a reaction vertex having more than two adjacent species vertices.*

(ii) *There is a species vertex having more than two adjacent reaction vertices.*

The proposition provides motivation for the following definition:

Definition 5.9. A source-block in the sign-causality graph is a *species block* (*S-block*) if each species node is adjacent to precisely two reaction nodes. A source-block in the sign-causality graph is a *reaction block* (*R-block*) if each reaction node is adjacent to precisely two species nodes.

Proposition 5.8 tells us that when condition (ii) of Theorem 2.6 is satisfied, every block within the sign-causality graph source is either an S-block or an R-block (or both in the case that the source-block is simply a single cycle). Note that in Figure 3 we have labeled the hypothetical source-blocks as RBn or SBn according to whether the corresponding source-block in Figure 2 is an R-block or an S-block.

We conclude this section with two more propositions. Neither is essential to the proofs of the main theorems of this paper, but they provide some additional and not-so-obvious properties of a sign-causality graph source.

The following proposition, proved in Appendix A, does not presuppose that condition (ii) of Theorem 2.1 is satisfied. Rather, it tells us about

properties of R-blocks or S-blocks that might exist within a sign-causality-graph source. We already know that every directed cycle is even, but the proposition tells us that *all* cycles within a source’s R-blocks and S-blocks are even.

Proposition 5.10. *Every (not necessarily directed) cycle that lies within an S-block or an R-block of a sign-causality graph source is even.*

The following proposition is a direct consequence of the two preceding ones:

Proposition 5.11. *Suppose that, for the reaction network under consideration, the Species-Reaction Graph satisfies condition (ii) of Theorem 2.1. Then in any source of the sign-causality graph every cycle is even.*

5.7 Properties of an end S-block

Recall that an *end* S-block in a source is an S-block that contains at most one separating vertex of the source. We consider properties of such an end S-block, designated ESB. There are three mutually exclusive possibilities: ESB contains no separating vertex at all; it contains just one separating vertex, and it is a reaction vertex; or it contains just one separating vertex, and it is a species vertex. For our purposes the first two possibilities can be treated together, while the third requires other considerations.

In fact, we show that when condition (i) of Theorem 2.1 holds, the first two possibilities cannot obtain; moreover, if the third obtains, we get sharpened information about the inequality in (25) corresponding to species at the block’s separating vertex.

5.7.1 Possibilities 1 and 2: ESB contains no separating vertex of the source or it contains a separating reaction vertex of the source

Because it is strongly connected, ESB must contain a directed (and even) cycle, which we take to be

$$s_1 \rightsquigarrow R_1 \rightsquigarrow s_2 \rightsquigarrow R_2 \cdots \rightsquigarrow s_n \rightsquigarrow R_n \rightsquigarrow s_1. \quad (28)$$

Because ESB is a species-block and because the block contains no separating species-vertex of the source, each of the species in the block (and in the

chosen cycle) is adjacent to at most two reactions of the block. Thus, the inequalities (25) corresponding to s_1, s_2, \dots, s_n reduce to

$$\begin{aligned} f_{R_n \rightsquigarrow s_1} |\alpha_{R_n}| - e_{s_1 \rightsquigarrow R_1} |\alpha_{R_1}| &> 0, \\ f_{R_1 \rightsquigarrow s_2} |\alpha_{R_1}| - e_{s_2 \rightsquigarrow R_2} |\alpha_{R_2}| &> 0, \\ &\vdots \\ f_{R_{n-1} \rightsquigarrow s_n} |\alpha_{R_{n-1}}| - e_{s_n \rightsquigarrow R_n} |\alpha_{R_n}| &> 0. \end{aligned} \tag{29}$$

(Recall that, for a species-to-reaction edge $s \rightsquigarrow R$ of the sign-causality graph we denote by $e_{s \rightsquigarrow R}$ the stoichiometric coefficient of species s in the corresponding edge-labeling complex. For a reaction-to-species edge $R \rightsquigarrow s$ we denote by $f_{R \rightsquigarrow s}$ the stoichiometric coefficient of species s in its edge-labeling complex.) By sequentially invoking these inequalities from top to bottom, we can deduce from the last of them that

$$\left(\frac{f_{R_1 \rightsquigarrow s_2} f_{R_2 \rightsquigarrow R_3} \cdots f_{R_n \rightsquigarrow s_1}}{e_{s_1 \rightsquigarrow R_1} e_{s_2 \rightsquigarrow R_2} \cdots e_{s_n \rightsquigarrow R_n}} - 1 \right) |\alpha_{R_n}| > 0. \tag{30}$$

However, when condition (i) of Theorem 2.1 holds, (30) cannot obtain: By supposition $|\alpha_{R_n}|$ is positive. Given the \rightsquigarrow -orientation in the SR Graph, the even cycle (28) (viewed in the SR Graph) cannot be stoichiometrically expansive, so the first factor on the left of (30) is either zero or negative. (Recall (27).) Thus, we have a contradiction of (30).

We conclude, then, that when condition (i) of Theorem 2.1 holds, an end S-block must contain a separating *species* vertex of the source. We investigate next what happens in that case.

5.7.2 Possibility 3: ESB contains a separating species vertex of the source

Here again we consider a directed cycle in ESB, labeled as in (28). If ESB's (unique) separating species vertex is not in the cycle, then we would again obtain a contradiction, just as in § 5.7.1. We suppose, then, that species s_n is the separating vertex. Because ESB is a species-block, all other species vertices of the cycle are adjacent to precisely two reaction vertices, and those are in the cycle. Thus, all inequalities but the last in (29) remain unchanged.

On the other hand, s_n is adjacent not only to R_{n-1} and R_n but also to certain reactions from nearby blocks sharing s_n as a species. Recall that \mathcal{R}_0 is the set of all reactions in the source under study. We denote by \mathcal{R}_{ESB} the

set of reactions in ESB and by $\mathcal{R}_0 \setminus \mathcal{R}_{ESB}$ the set of all source reactions not in ESB. Moreover, we let $\mathcal{R}_0 \setminus \mathcal{R}_{ESB} \rightsquigarrow s_n$ and $s_n \rightsquigarrow \mathcal{R}_0 \setminus \mathcal{R}_{ESB}$ be the sets of source edges residing outside of ESB that are, respectively, directed toward and away from species s_n .

In this case, the last inequality in (29) must be replaced by

$$\begin{aligned} & f_{R_{n-1} \rightsquigarrow s_n} |\alpha_{R_{n-1}}| - e_{s_n \rightsquigarrow R_n} |\alpha_{R_n}| + \\ & \sum_{\mathcal{R}_0 \setminus \mathcal{R}_{ESB} \rightsquigarrow s_n} f_{R \rightsquigarrow s_n} |\alpha_R| - \sum_{s_n \rightsquigarrow \mathcal{R}_0 \setminus \mathcal{R}_{ESB}} e_{s_n \rightsquigarrow R} |\alpha_R| > 0. \end{aligned} \quad (31)$$

Instead of (30), this time we deduce the inequality

$$\begin{aligned} & \left(\frac{f_{R_1 \rightsquigarrow s_2} f_{R_2 \rightsquigarrow R_3} \cdots f_{R_n \rightsquigarrow s_1}}{e_{s_1 \rightsquigarrow R_1} e_{s_2 \rightsquigarrow R_2} \cdots e_{s_n \rightsquigarrow R_n}} - 1 \right) |\alpha_{R_n}| + \\ & \sum_{\mathcal{R}_0 \setminus \mathcal{R}_{ESB} \rightsquigarrow s_n} f_{R \rightsquigarrow s_n} |\alpha_R| - \sum_{s_n \rightsquigarrow \mathcal{R}_0 \setminus \mathcal{R}_{ESB}} e_{s_n \rightsquigarrow R} |\alpha_R| > 0. \end{aligned} \quad (32)$$

When condition (i) of Theorem 2.1 obtains, however, the first term on the left cannot be positive for reasons given in §5.7.1. Thus, we arrive at the following inequality, *which relates entirely to source edges disjoint from ESB*:

$$\sum_{\mathcal{R}_0 \setminus \mathcal{R}_{ESB} \rightsquigarrow s_n} f_{R \rightsquigarrow s_n} |\alpha_R| - \sum_{s_n \rightsquigarrow \mathcal{R}_0 \setminus \mathcal{R}_{ESB}} e_{s_n \rightsquigarrow R} |\alpha_R| > 0. \quad (33)$$

For species s_n this amounts to a sharpened form of its counterpart in (25), a form we will draw upon later on.

5.8 Properties of an end R-block

We begin this subsection with an important proposition about R-blocks. A proof is provided in Appendix B.

Proposition 5.12. *Suppose that, in a sign-causality graph source, an R-block has species set \mathcal{S}^* , and suppose that no directed cycle in the block is stoichiometrically expansive relative to the \rightsquigarrow orientation. Then there is a set of positive numbers $\{M_s\}_{s \in \mathcal{S}^*}$ such that, for each causal unit $s \rightsquigarrow R \rightsquigarrow s'$ in the block, the following relation is satisfied:*

$$f_{R \rightsquigarrow s'} M_{s'} - e_{s \rightsquigarrow R} M_s \leq 0. \quad (34)$$

Now we consider an end R-block in the source under consideration, designated ERB. We denote by \mathcal{S}^* the set of species in ERB. In consideration of the source inequality system (25), we restrict our attention to just those inequalities corresponding to species in \mathcal{S}^* :

$$\sum_{\mathcal{R}_0 \rightsquigarrow s} f_{R \rightsquigarrow s} |\alpha_R| - \sum_{s \rightsquigarrow \mathcal{R}_0} e_{s \rightsquigarrow R} |\alpha_R| > 0, \quad \forall s \in \mathcal{S}^*. \quad (35)$$

We suppose that condition (i) of Theorem 2.1 is satisfied, so, by virtue of Remark 5.7, we can choose $\{M_s\}_{s \in \mathcal{S}^*}$ as in Proposition 5.12. If we multiply each inequality in (35) by the corresponding M_s and sum, we get the single inequality shown in (36).

$$\sum_{s \in \mathcal{S}^*} \left(\sum_{\mathcal{R}_0 \rightsquigarrow s} f_{R \rightsquigarrow s} M_s |\alpha_R| - \sum_{s \rightsquigarrow \mathcal{R}_0} M_s e_{s \rightsquigarrow R} |\alpha_R| \right) > 0 \quad (36)$$

As in §5.7 there are three possibilities: ERB contains no separating vertex; it contains just one separating vertex, and it is a reaction vertex; or it contains just one separating vertex, and it is a species vertex. We will show that neither of the first two possibilities can obtain. Then, as in §5.7.2, we will show that, if the third possibility is realized, the inequality in (25) corresponding to the species at the separating vertex can be sharpened to considerable advantage.

5.8.1 Possibilities 1 and 2: ERB contains no separating vertex of the source or it contains a separating reaction vertex of the source

Because ERB is an R-block, each reaction is adjacent to precisely two species in the set \mathcal{S}^* , which is to say that each reaction in ERB sits at the center of precisely one causal unit in ERB. (Recall that ERB is strongly connected.) Moreover, if either of the first two possibilities should obtain, no species is adjacent to a reaction not in ERB. In these cases, the inequality (36) can be rewritten. Let \mathcal{U} be the set of causal units within ERB. Then (36) can be made to take the form shown in (37).

$$\sum_{s \rightsquigarrow R \rightsquigarrow s' \in \mathcal{U}} (f_{R \rightsquigarrow s'} M_{s'} - e_{s \rightsquigarrow R} M_s) |\alpha_R| > 0 \quad (37)$$

However, (37) is contradicted by the attributes given to the set $\{M_s\}_{s \in \mathcal{S}^*}$ in Proposition 5.12.

Thus, neither of the first two possibilities can obtain. ERB must contain a separating species vertex of the source. We examine next what can be said in that case.

5.8.2 Possibility 3: ERB contains a separating species vertex of the source

Suppose that ERB contains a species vertex s^* that is a separating vertex of the source under consideration. When condition (i) of Theorem 2.1 obtains, we can again choose positive numbers $\{M_s\}_{s \in \mathcal{S}^*}$ to satisfy the requirements of Proposition 5.12, and the inequality (36) remains in force. On the other hand the passage from (36) to (37) becomes confounded by the fact that species vertex s^* is now adjacent to source edges not residing in ERB. We denote by \mathcal{R}_{ERB} the set of reactions in ERB and by $\mathcal{R}_0 \setminus \mathcal{R}_{ERB}$ the set of all source reactions not in ERB. Moreover, we let $\mathcal{R}_0 \setminus \mathcal{R}_{ERB} \rightsquigarrow s^*$ and $s^* \rightsquigarrow \mathcal{R}_0 \setminus \mathcal{R}_{ERB}$ be the sets of source edges residing outside of ERB that are, respectively, directed toward and away from species s^* . As before, we let \mathcal{U} be the set of causal units in ERB. In this case, (36) can be recast as (38).

$$\begin{aligned} & \sum_{s \rightsquigarrow R \rightsquigarrow s' \in \mathcal{U}} (f_{R \rightsquigarrow s'} M_{s'} - e_{s \rightsquigarrow R} M_s) |\alpha_R| + \\ & M_{s^*} \left(\sum_{\mathcal{R}_0 \setminus \mathcal{R}_{ERB} \rightsquigarrow s^*} f_{R \rightsquigarrow s^*} |\alpha_R| - \sum_{s^* \rightsquigarrow \mathcal{R}_0 \setminus \mathcal{R}_{ERB}} e_{s^* \rightsquigarrow R} |\alpha_R| \right) > 0 \end{aligned} \quad (38)$$

Recall that the set $\{M_s\}_{s \in \mathcal{S}^*}$ was chosen to satisfy the requirements of Proposition 5.12, so the first sum in (38) cannot be positive. Then, because M_{s^*} is positive, we must have

$$\sum_{\mathcal{R}_0 \setminus \mathcal{R}_{ERB} \rightsquigarrow s^*} f_{R \rightsquigarrow s^*} |\alpha_R| - \sum_{s^* \rightsquigarrow \mathcal{R}_0 \setminus \mathcal{R}_{ERB}} e_{s^* \rightsquigarrow R} |\alpha_R| > 0. \quad (39)$$

Note that this is a strengthened counterpart of the inequality in (25) corresponding to species s^* , *a counterpart that makes reference only to reactions external to the end reaction block ERB.*

5.9 The concluding argument: Leaf removal

We begin this subsection with a review of what was established in §5.7 and §5.8: An end block in a sign-causality graph source, be it an S-block or an

R-block, must contain a *species* separating vertex of the source. This implies that the hypothetical source depicted in Figure 2 (and having block-tree depicted in Figure 3) cannot in fact be a source, for it has an end block, corresponding to RB1 in Figure 3, that does not contain a separating *species* vertex of the putative source. (Each of the remaining end blocks does contain a separating species vertex.)

Moreover, we have established that the inequality in (25) corresponding to a separating species vertex s^* in an end block EB, be it an S-block or an R-block, can be strengthened to a form that makes no mention of reaction inside EB:

$$\sum_{\mathcal{R}_0 \setminus \mathcal{R}_{EB} \rightsquigarrow s^*} f_{R \rightsquigarrow s^*} |\alpha_R| - \sum_{s^* \rightsquigarrow \mathcal{R}_0 \setminus \mathcal{R}_{EB}} e_{s^* \rightsquigarrow R} |\alpha_R| > 0. \quad (40)$$

Here \mathcal{R}_{EB} is the set of reactions in EB, and $\mathcal{R}_0 \setminus \mathcal{R}_{EB}$ the set of source reactions not in EB. Moreover, $\mathcal{R}_0 \setminus \mathcal{R}_{EB} \rightsquigarrow s^*$ and $s^* \rightsquigarrow \mathcal{R}_0 \setminus \mathcal{R}_{EB}$ are the sets of source edges residing outside of EB that are, respectively, directed toward and away from species s^* .

Now if EB is an end block in the source under consideration, we can replace the inequality in (25) corresponding to the unique separating species vertex s^* in EB with its strengthened form shown in (40). Thereafter, we can restrict the now-modified inequality system (25) to just those inequalities corresponding to s^* and to species residing outside EB. In effect, the resulting reduced system of inequalities corresponds to a subgraph of the source with the end block EB removed, but with s^* retained. Viewed in the source's block tree, this corresponds to removal of a leaf along with that leaf's adjacent species separating vertex (when that separating vertex is not adjacent to a different leaf).

It is not difficult to see that the arguments in §5.7 or §5.8 can then be applied to any end block EB' of the resulting source subgraph to produce a still smaller but strengthened inequality system corresponding to a still smaller source subgraph, a subgraph resulting from removal of EB'.

The process can be continued, amounting to a sequential pruning of the source's block-tree, with each stage corresponding to removal of a (perhaps new) leaf and perhaps its adjacent species separating vertex. The process will terminate when only one block remains, with the final source subgraph having no separating vertex at all. In this case, by arguments of §5.7.1 or §5.8.1 the corresponding reduced inequality system cannot be satisfied, and we have a contradiction.

This completes the proof of Theorem 2.1.

6 Proof of Theorem 2.6

Here we prove Theorem 2.6, which is repeated below:

Theorem 2.6 *A fully open reaction network is strongly concordant if its true-chemistry Species-Reaction Graph has the following properties:*

- (i) *Every even cycle is an s-cycle.*
- (ii) *No two even cycles have a species-to-reaction intersection.*

We begin by recalling the definition of strong concordance for an arbitrary reaction network $\{\mathcal{S}, \mathcal{C}, \mathcal{R}\}$, not necessarily fully open, with stoichiometric subspace $S \subset \mathbb{R}^{\mathcal{S}}$. Again we let $L : \mathbb{R}^{\mathcal{R}} \rightarrow S$ be the linear map defined by

$$L\alpha = \sum_{y \rightarrow y' \in \mathcal{R}} \alpha_{y \rightarrow y'} (y' - y). \quad (41)$$

Definition 6.1. A reaction network $\{\mathcal{S}, \mathcal{C}, \mathcal{R}\}$ with stoichiometric subspace S is *strongly concordant* if there do not exist $\alpha \in \ker L$ and a non-zero $\sigma \in S$ having the following properties:

- (i) For each $y \rightarrow y'$ such that $\alpha_{y \rightarrow y'} > 0$ there exists a species $s \in \text{supp}(y - y')$ for which $\text{sgn } \sigma_s = \text{sgn}(y - y')_s$.
- (ii) For each $y \rightarrow y'$ such that $\alpha_{y \rightarrow y'} < 0$ there exists a species $s \in \text{supp}(y - y')$ for which $\text{sgn } \sigma_s = -\text{sgn}(y - y')_s$.
- (iii) For each $y \rightarrow y'$ such that $\alpha_{y \rightarrow y'} = 0$, either (a) $\sigma_s = 0$ for all $s \in \text{supp } y$, or (b) there exist species $s, s' \in \text{supp}(y - y')$ for which $\text{sgn } \sigma_s = \text{sgn}(y - y')_s$ and $\text{sgn } \sigma_{s'} = -\text{sgn}(y - y')_{s'}$.

The following lemma will take us just short of a proof of Theorem 2.6. Proof of the lemma is given in Appendix C.

Lemma 6.2. *Suppose that a fully open reaction network with true chemistry $\{\mathcal{S}, \mathcal{C}, \mathcal{R}\}$ is not strongly concordant. Then there is another true chemistry $\{\mathcal{S}, \mathcal{C}, \bar{\mathcal{R}}\}$ whose fully open extension is discordant and whose SR Graph is identical to a subgraph of the SR Graph for $\{\mathcal{S}, \mathcal{C}, \mathcal{R}\}$, apart perhaps from changes in certain arrow directions within the reaction vertices.*

Proof of Theorem 2.6 proceeds from Lemma 6.2 in the following way:

Proof of Theorem 2.6. Suppose that the SR Graph for a true chemistry $\{\mathcal{S}, \mathcal{C}, \mathcal{R}\}$ satisfies conditions (i) and (ii) of the theorem but that, contrary to what is to be proved, the fully open extension of $\{\mathcal{S}, \mathcal{C}, \mathcal{R}\}$ is not strongly concordant. Note that when the SR Graph of a true chemistry $\{\mathcal{S}, \mathcal{C}, \mathcal{R}\}$ satisfies conditions (i) and (ii) of Theorem 2.6, so will any subgraph of that SR Graph. On the other hand, neither of those conditions depends upon the direction of arrows in the reaction nodes. Thus, the SR Graph of the true chemistry $\{\mathcal{S}, \mathcal{C}, \mathcal{R}\}$ given by the lemma will also satisfy conditions (i) and (ii). But then, by Corollary 2.4 of Theorem 2.1, the fully open extension of $\{\mathcal{S}, \mathcal{C}, \mathcal{R}\}$ could not be discordant, and we have a contradiction. \square

7 Extensions of the main theorems to networks that are not fully open

It is the purpose of this Section to elaborate on remarks made in §1.2.2.

When the SR Graph drawn for a true chemical reaction network satisfies the hypotheses of Theorems 2.1 or 2.6, these theorems tell us that the network’s fully open extension is concordant (or strongly concordant). In this case, the fully open network inherits the many attributes described in [18] that accrue to all concordant (or strongly concordant) networks. We would like to know circumstances under which these theorems can be extended in their range to give concordance information about networks that are not fully open.

More generally, we would like to know conditions under which, for a given network, concordance or strong concordance of the network’s fully open extension implies concordance or strong concordance of the network itself.¹⁰ This is a question quite separate from SR Graph considerations. However, when the network satisfies such conditions and its underlying true chemistry SR Graph satisfies the hypothesis of Theorems 2.1 or 2.6, then the concordance properties ensured by those theorems for the fully open extension will be inherited by the original network.

In [18] we showed that a *normal* network is concordant (strongly concordant) if its fully open extension is concordant (strongly concordant). Nor-

¹⁰We do not preclude the possibility that the original network contain *some* degradation reactions of the form $s \rightarrow 0$.

mality is a mild structural condition given in Definition 7.1 below. In [8] it was shown that *every weakly reversible network is normal*.

Theorems 7.10 and 7.11 below tell us that these same results also obtain for the still larger class of *weakly normal* networks. (See Definition 7.3.) In particular, a weakly normal network is concordant (strongly concordant) if its fully open extension is concordant (strongly concordant).

This improvement on results in [18] is helpful in itself, but it also has significance in another direction: We show in §7.1 that the class of weakly normal networks is synonymous with the very broad class of *nondegenerate* networks (Definition 7.6), which was described in the Introduction. Thus, *any nondegenerate reaction network with a concordant (strongly concordant) fully open extension is itself concordant (strongly concordant)*. Moreover, we also show that, with respect to the possibility of concordance, *degenerate* reaction networks are not worth considering, for they are never concordant.

In §7.3 we provide computational tests that serve to affirm network normality and weak normality (or, equivalently nondegeneracy).

7.1 Network normality, weak normality, and nondegeneracy

Definition 7.1. Consider a reaction network $\{\mathcal{S}, \mathcal{C}, \mathcal{R}\}$ with stoichiometric subspace S . The network is *normal* if there are $q \in \mathbb{R}_+^{\mathcal{S}}$ and $\eta \in \mathbb{R}_+^{\mathcal{R}}$ such that the linear transformation $T : S \rightarrow S$ defined by

$$T\sigma := \sum_{y \rightarrow y' \in \mathcal{R}} \eta_{y \rightarrow y'} (y * \sigma)(y' - y) \quad (42)$$

is nonsingular, where “ $*$ ” is the scalar product in $\mathbb{R}^{\mathcal{S}}$ defined by

$$x * x' := \sum_{s \in \mathcal{S}} q_s x_s x'_s. \quad (43)$$

Remark 7.2. As indicated earlier, it was shown in [8] that every weakly reversible network is normal. Reference [8] also contains structural conditions that ensure normality for certain “partially open” networks that are not weakly reversible.

In preparation for the next definition we note that (42) can be written as

$$T\sigma := \sum_{y \rightarrow y' \in \mathcal{R}} (\eta_{y \rightarrow y'} y \circ q) \cdot \sigma (y' - y), \quad (44)$$

where “ \cdot ” indicates the standard scalar product in $\mathbb{R}^{\mathcal{S}}$.

Definition 7.3. Consider a reaction network $\{\mathcal{S}, \mathcal{C}, \mathcal{R}\}$ with stoichiometric subspace S . The network is *weakly normal* if, for each reaction $y \rightarrow y'$, there is a vector $p_{y \rightarrow y'} \in \overline{\mathbb{R}}_+^{\mathcal{S}}$ with $\text{supp } p_{y \rightarrow y'} = \text{supp } y$ such that the linear transformation $\bar{T} : S \rightarrow S$ defined by

$$\bar{T}\sigma := \sum_{y \rightarrow y' \in \mathcal{R}} p_{y \rightarrow y'} \cdot \sigma (y' - y) \quad (45)$$

is nonsingular. Here “ \cdot ” is the standard scalar product in $\mathbb{R}^{\mathcal{S}}$.

Remark 7.4. A reaction network that is normal is also weakly normal. In fact, if $q \in \mathbb{R}_+^{\mathcal{S}}$ and $\eta \in \mathbb{R}_+^{\mathcal{R}}$ satisfy the requirements of Definition 7.1, then the choice $p_{y \rightarrow y'} := \eta_{y \rightarrow y'} y \circ q, \forall y \rightarrow y' \in \mathcal{R}$ will satisfy the requirements of Definition 7.3. On the other hand, a weakly normal network need not be normal. An example is given by

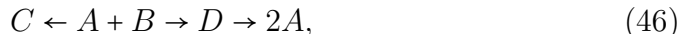

which is weakly normal but not normal. Because every weakly reversible network is normal, it follows that every weakly reversible network is also weakly normal.

Remark 7.5. For readers familiar with standard language of chemical reaction network theory [10], a network cannot be normal if

$$t - \ell - \delta > 0, \quad (47)$$

where t is the number of terminal strong linkage classes, ℓ is the number of linkage classes, and δ is the deficiency. This follows without much difficulty from [12]; see also [10]. For network (46), $t = 2$, $\ell = 1$, and $\delta = 0$, so normality is precluded by condition (47). Network (46) illustrates, however, that the same condition does not also preclude weak normality.

Definition 7.6. A reaction network is *nondegenerate* if there exists for it differentially monotonic kinetics (§3.2) such that at some positive composition c^* the derivative of the species-formation-rate function $df(c^*) : S \rightarrow S$ is nonsingular. Otherwise, the network is *degenerate*.

Proposition 7.7. *A reaction network is nondegenerate if and only if it is weakly normal.*

Proof. Suppose that a network $\{\mathcal{S}, \mathcal{C}, \mathcal{R}\}$ is nondegenerate. Then there is for the network a kinetics \mathcal{K} such that, at some composition $c^* \in \mathbb{R}_+^{\mathcal{S}}$, the kinetics is differentially monotonic and, moreover, the derivative of the species-formation-rate function, $df(c^*) : S \rightarrow S$, is nonsingular. In this case, for each $\sigma \in S$

$$df(c^*)\sigma = \sum_{y \rightarrow y' \in \mathcal{R}} \nabla \mathcal{K}_{y \rightarrow y'}(c^*) \cdot \sigma(y' - y), \quad (48)$$

where the components of $\nabla \mathcal{K}_{y \rightarrow y'}(c^*)$ have the non-negativity properties that follow from differentiable monotonicity (§3.2). By taking

$$p_{y \rightarrow y'} = \nabla \mathcal{K}_{y \rightarrow y'}(c^*), \quad \forall y \rightarrow y' \in \mathcal{R}$$

we can establish that the network is weakly normal.

On the other hand, suppose that the network $\{\mathcal{S}, \mathcal{C}, \mathcal{R}\}$ is weakly normal and, in particular, that the set $\{p_{y \rightarrow y'}\}_{y \rightarrow y' \in \mathcal{R}}$ satisfies the requirements of Definition 7.3. Let \mathcal{K} be the (differentially monotonic) kinetics defined by

$$\mathcal{K}_{y \rightarrow y'}(c) := c^{p_{y \rightarrow y'}}, \quad \forall y \rightarrow y' \in \mathcal{R},$$

and let $c^* \in \mathbb{R}_+^{\mathcal{S}}$ be such that $c_s^* = 1$ for each $s \in \mathcal{S}$. Note that

$$\nabla \mathcal{K}_{y \rightarrow y'}(c^*) = p_{y \rightarrow y'}, \quad \forall y \rightarrow y' \in \mathcal{R}.$$

From this, (48), and the properties of the set $\{p_{y \rightarrow y'}\}_{y \rightarrow y' \in \mathcal{R}}$ given by Definition 7.3 it follows that $df(c^*) : S \rightarrow S$, is nonsingular, whereupon the network is nondegenerate. \square

Remark 7.8. Note that in the proof that nondegeneracy implies weak normality we did not actually require that the network be nondegenerate. In particular, we did not require that the kinetics \mathcal{K} be differentially monotonic at *all* positive compositions, only that it be differentially monotonic at *one* composition, c^* (and, of course, that $df(c^*)$ be nonsingular). However, when these apparently milder conditions are invoked, the network *must* be nondegenerate nevertheless: The seemingly milder conditions result in weak normality, and, as the second part of the proof indicates, weak normality implies nondegeneracy.

The following proposition indicates that a network that is not weakly normal (or, equivalently, is degenerate) has no chance of being concordant.

Proposition 7.9. *A reaction network that is not weakly normal is discordant. Equivalently, every degenerate network is discordant.*

Proof. Suppose that a reaction network $\{\mathcal{S}, \mathcal{C}, \mathcal{R}\}$ is not weakly normal (and, in particular, is not normal). From Definition 7.3 it follows that, for the special choice $p_{y \rightarrow y'} = y$, $\forall y \rightarrow y' \in \mathcal{R}$, the corresponding map $\bar{T} : S \rightarrow S$ given by (45) must be singular. This is to say that there is a nonzero $\sigma^* \in S$ such that

$$\sum_{y \rightarrow y' \in \mathcal{R}} y \cdot \sigma^*(y' - y) = 0.$$

Now let $\alpha \in \mathbb{R}^{\mathcal{R}}$ be defined by $\alpha_{y \rightarrow y'} = y \cdot \sigma^*$, $\forall y \rightarrow y' \in \mathcal{R}$. Then, in view of Definition 4.1, the pair consisting of α and σ^* serve to establish discordance of the network under consideration. \square

7.2 Concordance of a network and of its fully open extension

The following theorems about weakly normal networks amount to straightforward extensions of theorems in [18] about normal networks; the proofs are almost identical. Although these theorems give the former ones a somewhat greater range, their main interest lies in the fact that they can be stated in terms of the more tangible, but equivalent, notion of network nondegeneracy.

Theorem 7.10. *A weakly normal (or, equivalently, nondegenerate) network is concordant if its fully open extension is concordant. In particular, a weakly reversible network is concordant if its fully open extension is concordant.*

Theorem 7.11. *A weakly normal (or, equivalently, nondegenerate) network is strongly concordant if its fully open extension is strongly concordant. In particular, a weakly reversible network is strongly concordant if its fully open extension is strongly concordant.*

Taken together, Proposition 7.7, Proposition 7.9, Theorem 7.10, and Theorem 7.11 tell us that, in the class of networks that have a concordant (strongly concordant) fully open extension, the concordant (strongly concordant) ones are *precisely* the nondegenerate ones:

Corollary 7.12. *Consider a reaction network that has a concordant (strongly concordant) fully open extension. Then the original network is concordant (strongly concordant) if and only if it is nondegenerate.*

Remark 7.13. It is a consequence of Theorem 7.10 and results in [18] that the dynamical statements (i) - (iii) of Theorem 2.8 hold true for any nondegenerate reaction network whose fully open extension is concordant, not merely those that satisfy the SR Graph conditions of Theorem 2.1. In particular, the “all or nothing” observation of Remark 2.9 still obtains. The SR Graph conditions of Theorem 2.1 merely suffice to ensure concordance of the fully open extension.

7.3 Tests for network normality, weak normality, and nondegeneracy

Here we provide some computational means to affirm normality and weak normality (or, equivalently, nondegeneracy) of a reaction network. Recall that the rank of a network is the rank of its set of reaction vectors.

Proposition 7.14. *A reaction network $\{\mathcal{S}, \mathcal{C}, \mathcal{R}\}$ of rank r is weakly normal (or, equivalently, nondegenerate) if there is a set of r reactions $\{y_i \rightarrow y'_i\}_{i=1\dots r}$ and a set of vectors $\{p_i\}_{i=1\dots r} \subset \overline{\mathbb{R}}_+^{\mathcal{S}}$ with $\text{supp } p_i = \text{supp } y_i$, $i = 1 \dots r$, such that the matrix*

$$[p_i \cdot (y'_j - y_j)]_{i,j=1\dots r} \quad (49)$$

has nonzero determinant.

Proof of the proposition is provided at the end of this subsection. For a particular choice of r reactions one can readily construct the matrix (49) in terms of symbols for the species-wise components of the vectors $\{p_i\}_{i=1\dots r}$, and one can then calculate the determinant of the matrix as a polynomial in those same symbols. If, for *even one* choice of r reactions, the resulting determinant is not *identically* zero, then the network is weakly normal.

We remark in passing that a nonzero determinant will require that the r reaction vectors $\{y'_i - y_i\}_{i=1\dots r}$ be linearly independent. Of course, such independent reaction vector sets will invariably exist for a network of rank r .

A special choice of $\{p_i\}_{i=1\dots r}$, one that obviates the need for symbolic computation, is invoked in the following corollary. This choice will often suffice to establish weak normality. In fact, when the condition in Corollary

7.15 below is satisfied, the network will not only be weakly normal but also normal. (See Remark 7.18 following the proof of Proposition 7.14.)

Corollary 7.15. *A reaction network $\{\mathcal{S}, \mathcal{C}, \mathcal{R}\}$ of rank r is weakly normal (and, in fact, normal) if there is a set of r reactions $\{y_i \rightarrow y'_i\}_{i=1\dots r}$ such that the matrix*

$$\left[y_i \cdot (y'_j - y_j) \right]_{i,j=1\dots r} \quad (50)$$

has nonzero determinant.

Example 7.16. Here we apply Corollary 7.15 to network (1), the rank of which is 4. For the four-reaction set

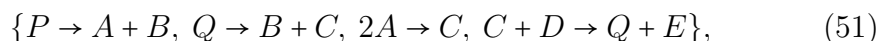

it is easy to calculate that the matrix in the corollary has a determinant of 4, so the network is weakly normal. Recall that Theorem 2.1 established the concordance of the fully open extension of network (1). Because network (1) is weakly normal, concordance of its fully open extension extends to network (1) itself.

Remark 7.17. Corollary 7.15 is only one consequence of Proposition 7.14. There are other, more interesting ones (some with a graphical flavor) that we intend to take up in another article. For example, a network $\{\mathcal{S}, \mathcal{C}, \mathcal{R}\}$ of rank r is weakly normal if there exist r reactions $\{y_i \rightarrow y'_i\}_{i=1\dots r}$ with the following property: There is a set of distinct species $\mathcal{S}_* = \{s_1, \dots, s_r\}$ with $s_i \in \text{supp } y_i$, $i = 1 \dots r$, such that

$$\det \left[s_i \cdot (y'_j - y_j) \right]_{i,j=1\dots r} \neq 0. \quad (52)$$

It is not difficult to see that (52) has the following interpretation: Let $\{\bar{y}_i \rightarrow \bar{y}'_i\}_{i=1\dots r}$ denote the set of “reactions” obtained from $\{y_i \rightarrow y'_i\}_{i=1\dots r}$ by stripping away all species not in \mathcal{S}_* . Then (52) is satisfied (whereupon the original network is weakly normal) precisely when the resulting set of “reaction vectors” $\{\bar{y}'_i - \bar{y}_i\}_{i=1\dots r}$ is linearly independent.

Proof of Proposition 7.14. Suppose that the reaction vector set $\{y'_i - y_i\}_{i=1\dots r}$ and the set $\{p_i\}_{i=1\dots r} \subset \overline{\mathbb{R}}_+^{\mathcal{S}}$ satisfy the conditions of the Proposition 7.14. In this case, it is not difficult to see that each of these sets must be linearly independent. In particular, the set $\{y'_i - y_i\}_{i=1\dots r}$ is a basis for S , the stoichiometric subspace for the network under consideration.

We begin by constructing the linear transformation $\bar{T}_0 : S \rightarrow S$ defined by

$$\bar{T}_0 \sigma = \sum_{i=1}^r p_i \cdot \sigma(y'_i - y_i), \quad \forall \sigma \in S, \quad (53)$$

which can be seen to be nonsingular in the following way: Suppose on the contrary that there is a nonzero $\sigma^* \in S$ such that $\bar{T}_0 \sigma^* = 0$. Because the set $\{y'_i - y_i\}_{i=1 \dots r}$ is linearly independent, we must have

$$p_i \cdot \sigma^* = 0, \quad i = 1 \dots r. \quad (54)$$

Because $\{y'_j - y_j\}_{j=1 \dots r}$ is a basis for S and σ^* is a nonzero member of S , there must be ξ_j , $j = 1 \dots r$, not all zero, such that

$$\sigma^* = \sum_{j=1}^r \xi_j (y'_j - y_j). \quad (55)$$

Insertion of this into (54) results in the system of r homogeneous equations

$$\sum_{j=1}^r p_i \cdot (y'_j - y_j) \xi_j = 0, \quad i = 1 \dots r \quad (56)$$

that must be satisfied by the set $\{\xi_j\}_{j=1 \dots r}$. Since the determinant of the matrix (49) is nonzero, the only solution is $\xi_j = 0$, $j = 1 \dots r$, which amounts to a contradiction. Thus, \bar{T}_0 is nonsingular, and, as a result, $\det \bar{T}_0 \neq 0$.

It remains to be shown that the requirements of weak normality are met by the network $\{\mathcal{S}, \mathcal{C}, \mathcal{R}\}$. For this purpose, let \mathcal{R}_0 be the set of aforementioned reactions $\{y_i \rightarrow y'_i\}_{i=1 \dots r}$. Moreover, let $p_{y \rightarrow y'} \in \bar{\mathbb{R}}_+^{\mathcal{S}}$ be chosen to satisfy

$$\begin{aligned} p_{y_i \rightarrow y'_i} &:= p_i, & \forall y_i \rightarrow y'_i \in \mathcal{R}_0 \\ p_{y \rightarrow y'} &:= \epsilon y, & \forall y \rightarrow y' \in \mathcal{R} \setminus \mathcal{R}_0, \end{aligned}$$

where ϵ is a small positive number. Now let $\bar{T}_\epsilon : S \rightarrow S$ be defined by

$$\begin{aligned} \bar{T}_\epsilon \sigma &:= \sum_{y \rightarrow y' \in \mathcal{R}} p_{y \rightarrow y'} \cdot \sigma(y' - y) \\ &= \bar{T}_0 \sigma + \epsilon \left[\sum_{y \rightarrow y' \in \mathcal{R} \setminus \mathcal{R}_0} y \cdot \sigma(y' - y) \right]. \end{aligned}$$

Note that $\bar{T}_\epsilon|_{\epsilon=0} = \bar{T}_0$. Because $\det \bar{T}_0 \neq 0$ and because $\det \bar{T}_\epsilon$ is continuous in ϵ , it follows that $\det \bar{T}_\epsilon \neq 0$ for ϵ sufficiently small. Thus, for sufficiently small ϵ , \bar{T}_ϵ is nonsingular, whereupon the network $\{\mathcal{S}, \mathcal{C}, \mathcal{R}\}$ is weakly normal. \square

Remark 7.18. Corollary 7.15 derives from Proposition 7.14 by invoking the special choice $p_i = y_i$, $i = 1 \dots r$. When the resulting condition in Corollary 7.15 is satisfied, the network at hand is not only weakly normal but also normal. To see this, it is enough to replace p_i by y_i everywhere in the proof of Proposition 7.14 and then invoke Definition 7.1 with $q_s = 1$, $\forall s \in \mathcal{S}$.

8 A Concluding Remark

When their hypotheses are satisfied, the central theorems of this article permit one to affirm concordance of a particular reaction network from inspection of its Species Reaction Graph and, then, to invoke all of the powerful dynamical consequences that concordance implies [18]. At the same time, these theorems provide delicately nuanced insight into network attributes that give rise to concordance. And, because their hypotheses are fairly easy to satisfy, the theorems tell us more — that concordance in realistic chemical reaction networks is likely to be common. Moreover, the theorems also serve to make connections between concordance results in [18] and earlier, somewhat different SR-Graph-related results contained in [1, 2, 7, 9, 17].

It should be remembered, however, that computational means for direct determination of whether a particular network — *fully open or otherwise* — is concordant *or discordant*, strongly concordant *or not strongly concordant*, are already available in user-friendly, freely-provided software [15] prepared in connection with [18]. In most instances, this software or a variant of it, will be the tool of choice.

Appendices

A Proof of Propositions 5.8 and 5.10

A.1 Some graph theoretical preliminaries: Ears

In this sub-section we describe a small amount of graph-theoretical material, all of which is available in [4]. In a directed graph G let F be a proper subgraph of G (with edge-directions inherited from G). A *directed ear* of F in G is a directed path in G whose end vertices lie in F but whose other vertices do not. In Figure 4 we show a hypothetical source block, and we consider the proper subgraph with vertices S_1, S_2, R_1, R_2, R_3 and the directed edges connecting them. Within the full graph, the path $S_1 \rightsquigarrow R_4 \rightsquigarrow S_3 \rightsquigarrow R_2$ is a directed ear of that subgraph.

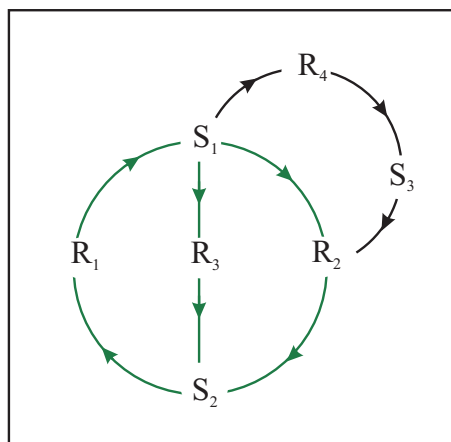

Figure 4: A directed ear

Three propositions will be helpful later on, all applicable to nonseparable strongly connected directed graphs, of which a source-block in the sign-causality graph is an example. The first two propositions culminate in the third.

Proposition A.1. [4] *Let F be a (nontrivial) strongly connected nonseparable proper subgraph of a nonseparable strongly connected directed graph G . Then F has a directed ear in G .*

Proposition A.2. [4] *Let F be a strongly connected subgraph of a directed graph G , and let P be directed ear of F in G . Then $F \cup P$ is strongly connected.*

A *directed ear decomposition* of a nonseparable strongly connected directed graph G is a sequence of nonseparable strongly connected directed subgraphs of G , say G_0, G_1, \dots, G_k , such that $G_i \subset G_{i+1}$, $i = 0, \dots, k - 1$ and such that

1. G_0 is a directed cycle,
2. $G_{i+1} = G_i \cup P_i$, where P_i is a directed ear of G_i in G , $i = 0, \dots, k - 1$,
3. $G_k = G$.

In effect, the following proposition tells us that a nonseparable strongly connected directed graph — in particular, a source block — can be built up by beginning with a directed cycle and successively adding directed ears. (It is left understood that we have in mind graphs with more than one vertex.)

Proposition A.3. [4] *Every nonseparable strongly connected directed graph has a directed ear decomposition.*

A.2 Two lemmas about R-to-R and S-to-S intersections of even cycles

Here we will argue that when, in the sign-causality graph or the SR Graph, two (not-necessarily directed) even cycles intersect in either an R-to-R path or an S-to-S path, then the third cycle so-formed is also even. We begin by considering the harder case, involving an R-to-R intersection. In the following lemma, when we indicate a path by a symbol such as R^*AR^{**} , the A does not denote a species. Rather R^*AR^{**} indicates a perhaps long path connecting reactions R^* and R^{**} .

Lemma A.4. *Suppose that in the sign-causality graph (or in the SR Graph) there are distinct reactions R^* and R^{**} and three edge-disjoint (not-necessarily-directed) paths, denoted R^*AR^{**} , R^*BR^{**} , and R^*CR^{**} , connecting R^* to R^{**} . If the cycles $R^*BR^{**}AR^*$ and $R^*CR^{**}BR^*$ are both even, then so is the cycle $R^*CR^{**}AR^*$.*

Proof. We begin by noting that both R^* and R^{**} will each have adjacent to them three distinct edges. Because there are only two possible labels for each edge (the reactant and product complexes of the adjacent reaction), there must be at least one c-pair centered at R^* and at least one centered at R^{**} . (There might be more than one c-pair at R^* or R^{**} if all three adjacent edges carry the same complex label, but this can happen only in chemistries for which three or more species can appear in the same complex; we do not preclude this possibility.)

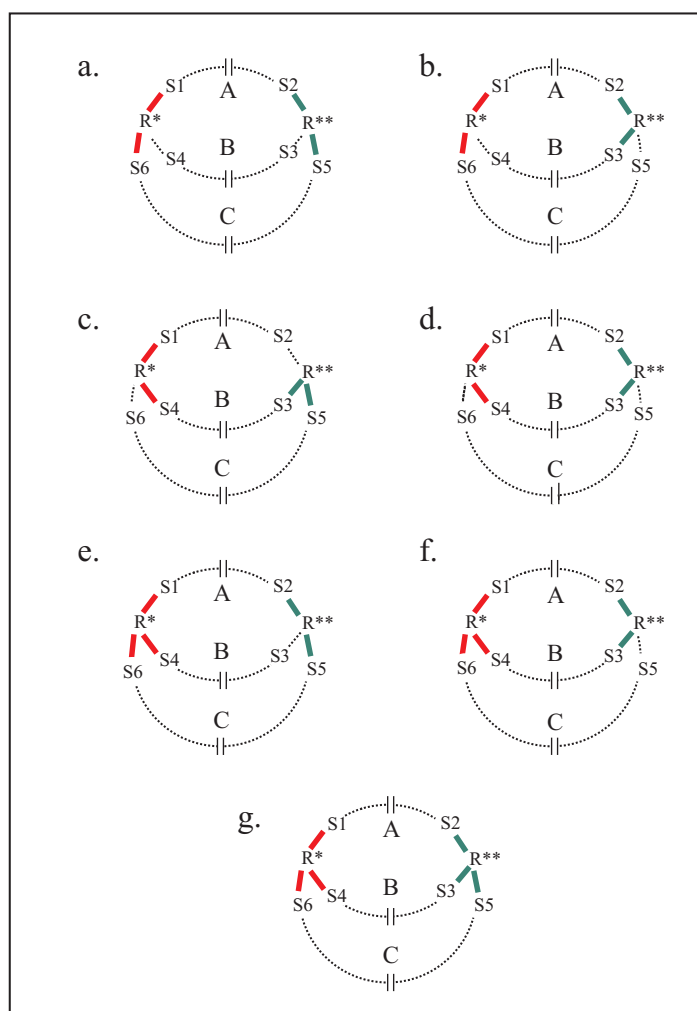

Figure 5: Illustration for the proof of Lemma A.4

We show the essentially distinct possibilities for distribution of c-pairs adjacent to R^* and R^{**} , relative to the paths R^*AR^{**} , R^*BR^{**} , and R^*CR^{**} , in Figure 5. (We have omitted from the figure cases in which S_1 coincides with S_2 , S_3 coincides with S_4 , or S_5 coincides with S_6 , but analyses of these are not substantially different from those of the cases shown.)

The proof essentially amounts to studying each case in Figure 5, beginning with an examination of the relative parity of the number of c-pairs within the species-to-species sub-paths connecting S_1 to S_2 , S_3 to S_4 , and S_5 to S_6 . From these considerations, it can be established in each case that the cycle $R^*CR^{**}AR^*$ has an even number of c-pairs.

Case (b) of the figure is typical: Because the cycle $R^*BR^{**}AR^*$ is even, because within the cycle there is a c-pair centered at R^{**} , and because within the cycle there is no c-pair centered at R^* , the parity of the number of c-pairs in the S_1 -to- S_2 path must be opposite from the parity of the number of c-pairs within the S_3 -to- S_4 path. Because the cycle $R^*CR^{**}BR^*$ is even and because there are no c-pairs in the cycle centered at R^* or R^{**} , the parity of the number of c-pairs in the S_5 -to- S_6 path is identical to the parity of the number of c-pairs in the S_3 -to- S_4 path. Thus the parity of the number of c-pairs in the S_1 -to- S_2 path is opposite to the parity of the number of c-pairs in the S_5 -to- S_6 , and we can conclude that the number of c-pairs in those two disjoint paths is odd. In the cycle $R^*CR^{**}AR^*$ there is precisely one additional c-pair — the one centered at R^* — so the cycle is even.

The remaining cases can be examined in the same way. \square

Lemma A.5. *Suppose that in the sign-causality graph (or in the SR Graph) there are distinct species S^* and S^{**} and three edge-disjoint (not-necessarily-directed) paths, denoted S^*AS^{**} , S^*BS^{**} , and S^*CS^{**} , connecting S^* to S^{**} . If the cycles $S^*BS^{**}AS^*$ and $S^*CS^{**}BS^*$ are both even, then so is the cycle $S^*CS^{**}AS^*$.*

Proof. Proof of this lemma is similar to the proof of Lemma A.4, but it is substantially simpler: Because c-pairs are centered at reaction vertices, all c-pairs will be interior to the paths S^*AS^{**} , S^*BS^{**} , and S^*CS^{**} . In fact, the hypothesis ensures that the number of c-pairs along all three paths will be even (respectively, odd) if that number is even (respectively, odd) along any one of them. From this it follows that the cycle $S^*CS^{**}AS^*$ is even. \square

A.3 Proof of Proposition 5.8

In this subsection we provide proof of Proposition 5.8, which is repeated below:

Proposition 5.8. *Suppose that, for the reaction network under consideration, the Species-Reaction Graph satisfies condition (ii) of Theorem 2.1. Then, in any source-block of the sign-causality graph, at most one of the following can obtain:*

- (i) *There is a reaction vertex having more than two adjacent species vertices.*
- (ii) *There is a species vertex having more than two adjacent reaction vertices.*

Throughout this subsection we assume that the Species-Reaction Graph of the network under consideration satisfies condition (ii) of Theorem 2.1. Because the putative source under consideration, viewed in the SR Graph, is a critical subgraph (Remark 5.5), it follows that no two even cycles in the source have an S-to-R intersection.

Consider a source-block G , which by its very nature is strongly connected and nonseparable, and let G_0, G_1, \dots, G_k be a directed ear decomposition of the block (§A.1). If the block consists of just a single directed cycle (i.e., if $G = G_0$), then each reaction is adjacent to precisely two species, and each species is adjacent to precisely two reactions. Thus the block is both an S-block and an R-block.

Suppose, then, that the block consists of more than a single directed cycle. Then G_1 is a directed cycle G_0 together with an adjoined directed ear P_0 of that cycle residing within the source-block. If that ear joins a reaction vertex to a species vertex of the cycle, then it is easy to see that G_1 will have two directed (and hence even) cycles with an S-to-R intersection, in which case condition (ii) of Theorem 2.1 would be violated.

Thus, there are two possibilities: Either the ear P_0 is a directed path joining two reactions of the original directed cycle G_0 or else the ear P_0 is a directed path that joins two species of that cycle. We shall suppose the former case and then argue in Lemma A.6 that all subsequent ears in the ear-decomposition must also be reaction-to-reaction paths. Thus, at each stage of the decomposition, new edges are adjoined to old vertices only at R-vertices. *In this case, the block can contain no species vertex adjacent to more than two edges. That is, the block is an S-block.*

If, on the other hand, the ear P_0 is a species-to-species path, then the block is an R-block by an almost identical argument, via Lemma A.7 below, with the roles of species and reactions reversed.)

Lemma A.6. *Suppose that, in a directed ear decomposition G_0, G_1, \dots, G_k of a source block G , no species vertex of G_i , $0 < i < k - 1$, is adjacent to more than two edges. Then the directed ear P_i , $0 < i < k - 1$, joins a reaction vertex of G_i to another reaction vertex of G_i .*

Lemma A.7. *Suppose that, in a directed ear decomposition G_0, G_1, \dots, G_k of a source block G , no reaction vertex of G_i , $0 < i < k - 1$, is adjacent to more than two edges. Then the directed ear P_i , $0 < i < k - 1$, joins a species vertex of G_i to another species vertex of G_i .*

We provide only the proof of Lemma A.6, for the proof of Lemma A.7 is the same, apart from a reversal of the roles of species and reactions.

Proof of Lemma A.6. The ear P_i can connect (1) a reaction vertex of G_i with a species vertex of G_i , (2) a species vertex of G_i with a species vertex of G_i , or (3) a reaction vertex of G_i with a reaction vertex of G_i . We will eliminate the first two possibilities.

(Case 1) Suppose that the directed ear P_i connects a reaction vertex of G_i , say R^* , with a species vertex of G_i , say S^* . We will suppose also that P_i is directed from S^* toward R^* ; if P_i is oppositely directed the argument is similar. See Figure 6. Because G_i is strongly connected there is a directed path (labeled A in the figure) entirely within G_i connecting S^* to R^* and also a directed path (labeled B) entirely within G_i connecting R^* to S^* .

If, apart from S^* and R^* , these paths have no vertex in common, then they form a directed (and therefore even) cycle within G_i , and one of them (path A), when taken with the directed ear P_i , forms a second directed (and therefore even) cycle that has an S-to-R intersection with the first cycle. This constitutes a violation of condition (ii) of Theorem 2.1. See Figure 6(a).

Suppose, then, that paths A and B have internal vertices in common. See Figure 6(b).¹¹ Adjacent to S^* there is an outgoing edge on path A and an incoming edge on path B . Thus, the reaction vertices adjacent to S^* on paths A and B are distinct. Now trace path B backward from S^*

¹¹To simplify the drawing in both Figures 6 and 7 we do not show paths A and B having common edges, but we do not preclude this possibility. The argument for Lemma A.6 does not require that paths A and B be edge-disjoint.

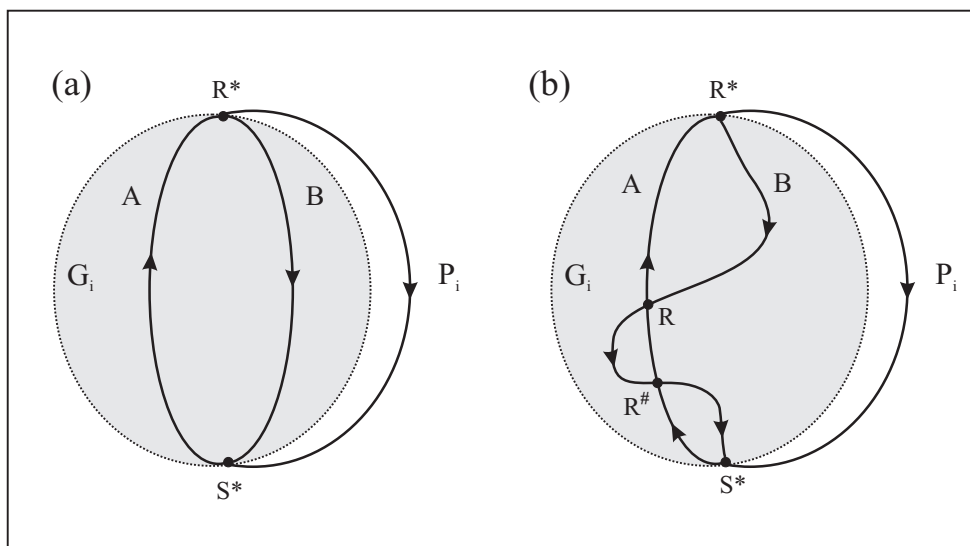

Figure 6: Case 1 in the proof of Lemma A.6

until its first intersection with path A at a vertex common to both paths. Because at least three edges within G_i meet in this common vertex, it must be a reaction vertex, which we call $R^\#$. We denote by $R^\#BS^*$ the directed sub-path along B connecting $R^\#$ to S^* and by $S^*AR^\#$ the directed sub-path along A connecting S^* to $R^\#$. By virtue of their construction, these two sub-paths have no internal vertices in common, so together they form a directed (and therefore even) cycle $S^*AR^\#BS^*$. Note that this cycle has the S-to-R intersection $S^*AR^\#$ with the directed (and therefore even) cycle formed from path A and the ear P_i . This contradicts condition (ii) of Theorem 2.1. Thus, the directed ear P_i cannot connect a reaction vertex of G_i with a species vertex of G_i .

(Case 2) Suppose that the directed ear P_i connects a species vertex of G_i , say S^* , with a different species vertex of G_i , say S^{**} , and that these vertices have been labeled so that the ear P_i is directed from S^* to S^{**} . Because G_i is strongly connected, there is a directed path (labeled A) within G_i that connects S^{**} to S^* and also a directed path (labeled B) within G_i that connects S^* to S^{**} . Should these two paths have internal vertices in common (Figure 7(a)) then, by an argument almost identical to one in Case 1, there would be a contradiction of condition (ii) of Theorem 2.1.

If, however, paths A and B have no internal vertices in common (Figure

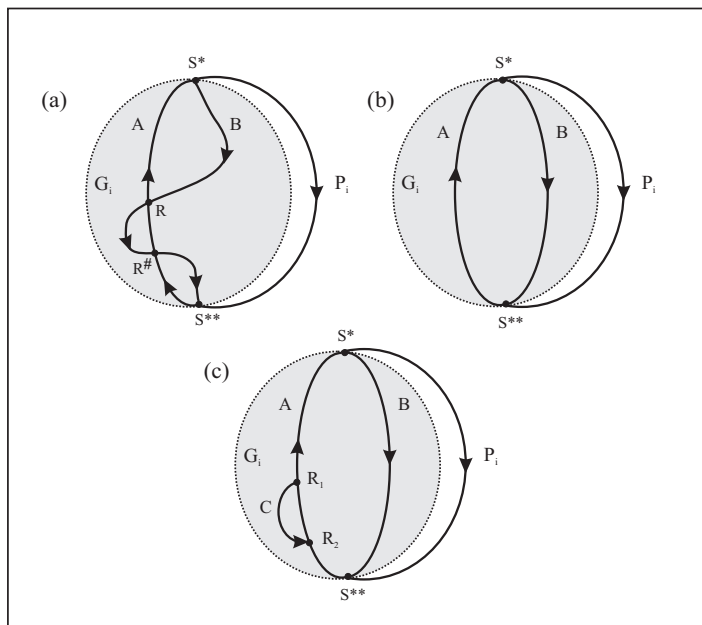

Figure 7: Case 2 in the proof of Lemma A.6

7(b)), then this by itself does not constitute a contradiction of condition (ii) of Theorem 2.1. On the other hand, G_i is a nonseparable and strongly connected directed graph that is not merely a directed cycle, so the directed cycle $S^{**}AS^*BS^{**}$ must have a directed ear within G_i , which we label C (Proposition A.1). Moreover, that ear can only connect two reaction vertices of the cycle because, by hypotheses, within G_i it is only reaction vertices that can be adjacent to more than two edges. (See Figure 7(c).) Thus the cycle $S^{**}AS^*BS^{**}$ has two disjoint directed ears, one (P_i) connecting a species vertex to a species vertex, and another (C) connecting a reaction vertex to a reaction vertex.

Note that in Figure 7(c) we show only one of several arrangements whereby the directed R-to-R and S-to-S ears can join to the directed cycle. We show in Figure 8 the essentially different arrangements. (In Figure 8, R_O and S_O are the cycle-vertices from which the ears are outgoing from the cycle, while R_I and S_I are the cycle-vertices to which the ears are incoming.) In each case there are two cycles — one containing the R-to-R ear and the other containing the S-to-S ear — that have an S-to-R intersection. (For readers with access to color these cycles are colored red and green.) Moreover, each

of these cycles is even, either because the cycle is directed or as a consequence of Lemma A.4 or A.5. Thus, condition (ii) of Theorem 2.1 is again violated.

We have shown that Cases 1 and 2 cannot obtain, so P_i must in fact join two R-vertices of G_i . □

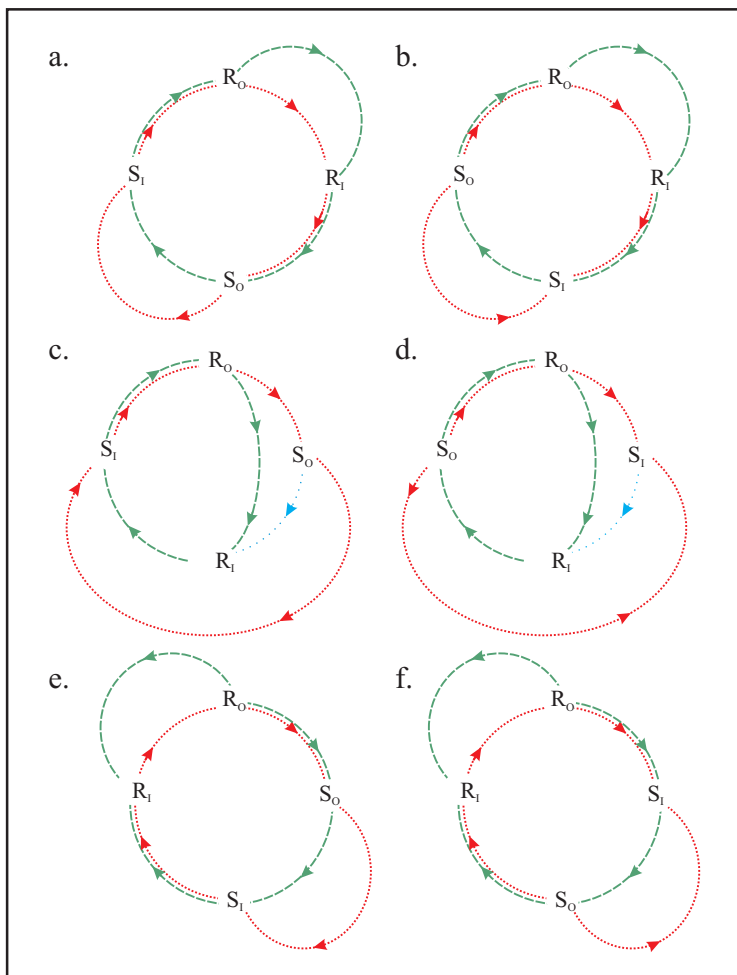

Figure 8: A directed cycle with disjoint directed R-to-R and S-to-S ears

Taken together, Lemmas A.6 and A.7 ensure that each source-block is either an S-block, an R-block, or a cycle, in which case it is both an S-block and an R-block.

A.4 Proof of Proposition 5.10

Here we prove Proposition 5.10, which is repeated below:

Proposition 5.10. *Every (not necessarily directed) cycle that lies within an S-block or an R-block of a sign-causality graph source is even.*

We consider a sign-causality graph source-block, G , which we will suppose to be an S-block. (Apart from a reversal of the roles of species and reactions, there is no difference in the proof if the source-block is an R-block.¹²) If G consists of a single cycle, that cycle is directed and therefore even. Suppose, then, that G consists of more than a single cycle.

Let G_0, G_1, \dots, G_k be a directed ear decomposition of G , so that G_0 is a directed (and therefore even) cycle and $G_k = G$. Proceeding inductively, we suppose that for a given value of i , $0 \leq i < k$, every cycle in G_i is even. We want to show that G_{i+1} has this same property. Note that G_{i+1} results from the addition to G_i of a directed ear P_i , which must join a reaction vertex of G_i , say R^* , to another reaction vertex of G_i , say R^{**} . (Recall that G is an S-block, so a species vertex can be adjacent to no more than two edges.)

Any cycle in G_{i+1} that is entirely within G_i is already even by the inductive hypothesis. A cycle in G_{i+1} that is not entirely within G_i must contain the ear P_i and is the union of P_i with a not-necessarily-directed path in G_i , denoted A , that connects R^* to R^{**} and that is (necessarily) edge-disjoint from P_i . Our aim is to show that the cycle $\mathcal{C}^\dagger := R^*P_iR^{**}AR^*$ is even.

Hereafter, if C is a path in G connecting R^* and R^{**} , and if R and R' are vertices along that path, we denote by RCR' the sub-path of C that connects R with R' . No direction is implied.

Because G_i is strongly connected, there is a directed path, labeled B_0 , that lies entirely within G_i and connects R^{**} to R^* . (See Figure 9(a).) Note that the cycle $\mathcal{C}_0 := R^*P_iR^{**}B_0R^*$ is even because it is directed. If the path B_0 has no edge in common with the path A , then the cycle $R^*AR^{**}B_0R^*$, which lies entirely within G_i is also even by the inductive hypothesis. In this case, Lemma A.4 ensures that the cycle $\mathcal{C}^\dagger = R^*P_iR^{**}AR^*$ is even, which is what we wanted to show.

On the other hand, suppose that the path B_0 does have one or more

¹²For an R-block, however, there is a substantially simpler argument. In an R-block every reaction vertex is adjacent to precisely two species vertices. From this and the fact that the block is strongly connected it follows that every cycle in the block is the union of causal units, so each must be even by an argument given in §5.3.

edges in common with the path A . If B_0 coincides with A then the cycle $\mathcal{C}^\dagger = R^*P_iR^{**}AR^*$ coincides with the even cycle $\mathcal{C}_0 = R^*P_iR^{**}B_0R^*$, in which case we are finished.

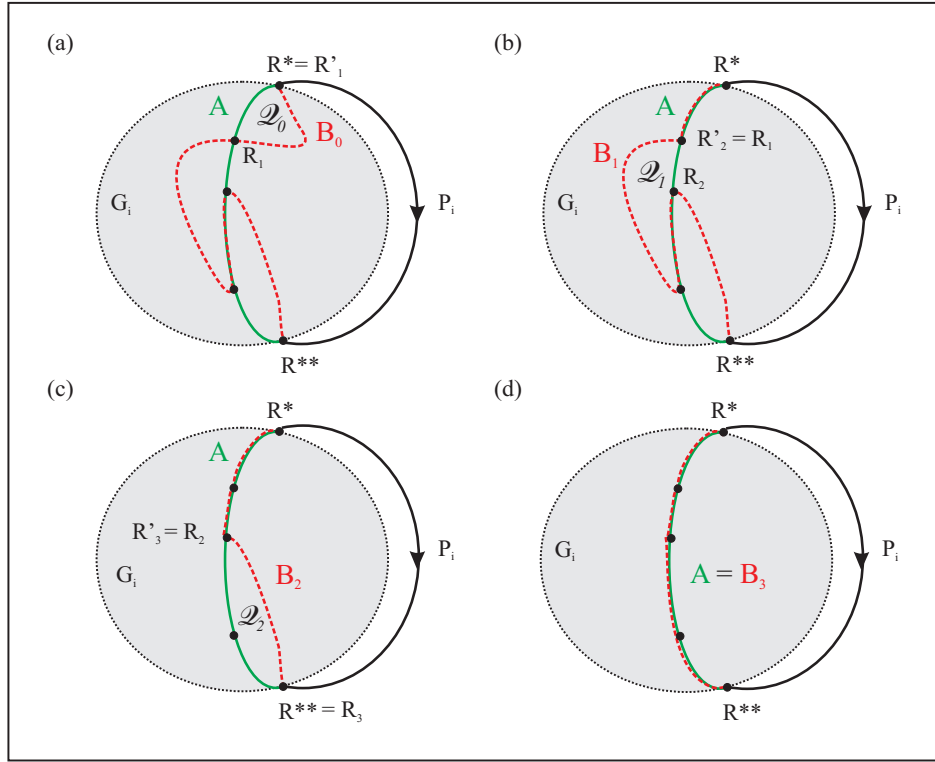

Figure 9: Schematic illustration for proof of Proposition 5.10

Suppose, therefore, that the path A contains an edge that is not contained in path B_0 , so the cycle \mathcal{C}^\dagger is different from the even cycle \mathcal{C}_0 . In this case we will argue that there is a sequence of cycles $\mathcal{C}_0, \mathcal{C}_1, \mathcal{C}_2, \dots, \mathcal{C}_p$ with the following properties:

- (i) \mathcal{C}_θ is even, $\theta = 0, \dots, p$.
- (ii) \mathcal{C}_θ is the union of P_i and a path B_θ that connects R^{**} with R^* and that lies entirely within G_i .
- (iii) The path B_θ contains a sub-path $R^*B_\theta R_\theta$ that lies entirely within path

A ; that is, $R^*B_\theta R_\theta = R^*AR_\theta$.¹³ Moreover, for $\theta > 0$, $R^*B_{\theta-1}R_{\theta-1}$ ($= R^*AR_{\theta-1}$) is properly contained within $R^*B_\theta R_\theta$ ($= R^*AR_\theta$).

(iv) $B_p = A$ (so that $\mathcal{C}_p = \mathcal{C}^\dagger$, whereupon \mathcal{C}^\dagger is even).

Because of the construction of \mathcal{C}_0 it satisfies conditions (i)-(iii). Suppose, then, that for a particular $\theta > 0$, \mathcal{C}_θ satisfies conditions (i)-(iii). We want to show that if path B_θ is not identical to path A , then there is a cycle $\mathcal{C}_{\theta+1}$ (and, in particular, a path $B_{\theta+1}$) such that the requirements of (i)-(iii) are met.

Suppose that path B_θ is not identical to path A . Moving away from R^* along path A , choose the first edge in A that is not in B_θ , and consider the longest sub-path of A that contains this edge and that has no edge in common with B_θ . It is not difficult to see that the end-vertices of this sub-path must be members of both A and B_θ and that each such end-vertex will be adjacent to at least three edges of G_{i+1} . Because G is an S-block, those end-vertices must be reaction vertices, denoted $R_{\theta+1}$ and $R'_{\theta+1}$, with $R_{\theta+1}$ denoting the end-vertex furthest from R^* along path A . (See Figure 9(a)-(c).) Note that the sub-path $R^*B_\theta R_\theta$ ($= R^*AR_\theta$) must be contained properly within $R^*AR_{\theta+1}$. Were it not, then $R'_{\theta+1}AR_{\theta+1}$ would lie entirely in B_θ , contradicting what has been assumed.

Because no edge of $R_{\theta+1}AR'_{\theta+1}$ is an edge of B_θ , the sub-paths $R_{\theta+1}B_\theta R'_{\theta+1}$ and $R_{\theta+1}AR'_{\theta+1}$ are edge-disjoint. Together they form a cycle,

$$\mathcal{Q}_\theta := R_{\theta+1}B_\theta R'_{\theta+1}AR_{\theta+1},$$

that is contained entirely within G_i and is therefore even by the inductive hypothesis.

Note that the even cycle \mathcal{C}_θ is not only the union of P_i and B_θ , it is also the union of the path $R'_{\theta+1}B_\theta R_{\theta+1}$ and its complementary path within \mathcal{C}_θ , the one connecting $R_{\theta+1}$ to $R'_{\theta+1}$ via path P_i . This last path we denote $R_{\theta+1}DR'_{\theta+1}$. Thus, we can write $\mathcal{C}_\theta = R'_{\theta+1}B_\theta R_{\theta+1}DR'_{\theta+1}$. Apart from vertices and edges that lie in P_i , all vertices and edges in $R_{\theta+1}DR'_{\theta+1}$ reside in B_θ .

Because the paths $R_{\theta+1}AR'_{\theta+1}$, $R_{\theta+1}B_\theta R'_{\theta+1}$ and $R_{\theta+1}DR'_{\theta+1}$ are edge-disjoint and because the cycles \mathcal{C}_θ and \mathcal{Q}_θ are even, it follows from Lemma A.4 that the cycle $\mathcal{C}_{\theta+1} := R'_{\theta+1}AR_{\theta+1}DR'_{\theta+1}$ is even. Thus, the cycle $\mathcal{C}_{\theta+1}$ satisfies condition (i) above.

¹³For $\theta = 0$, the sub-path mentioned might be the trivial one containing only the vertex R^* , in which case $R_0 = R^*$

Note that cycle $\mathcal{C}_{\theta+1}$ is union of P_i with the path

$$\begin{aligned} B_{\theta+1} &:= R^* B_\theta R'_{\theta+1} A R_{\theta+1} B_\theta R^{**} \\ &= R^* A R'_{\theta+1} A R_{\theta+1} B_\theta R^{**} \\ &= R^* A R_{\theta+1} B_\theta R^{**}. \end{aligned}$$

Thus, $\mathcal{C}_{\theta+1}$ satisfies condition (ii). Note too that, as indicated earlier, $R^* B_\theta R_\theta$ ($= R^* A R_\theta$) is properly contained within $R^* A R_{\theta+1}$. Thus, condition (iii) is also satisfied.

So long as B_θ is not identical to A these iterations can continue, with every new $B_{\theta+1}$ obtained by replacing a sub-path $R^* B_\theta R_{\theta+1}$ of B_θ with a sub-path $R^* A R_{\theta+1}$ of A , with each such sub-path of A strictly longer than its predecessor, $R^* A R_\theta$. Because A has a finite number of edges, the process must terminate with some B_p identical to A .

Thus, the cycle \mathcal{C}^\dagger , which is identical to \mathcal{C}_p , is even.

B Proof of Proposition 5.12.

In this appendix we prove Proposition 5.12, which is repeated below. The argument here has interesting connections to the mathematics in [11], a paper about detailed balance in mass action systems.

Proposition 5.12. *Suppose that, in a sign-causality graph source, an R-block has species set \mathcal{S}^* , and suppose that no directed cycle in the block is stoichiometrically expansive relative to the \rightsquigarrow orientation. Then there is a set of positive numbers $\{M_s\}_{s \in \mathcal{S}^*}$ such that, for each causal unit $s \rightsquigarrow R \rightsquigarrow s'$ in the block, the following relation is satisfied:*

$$f_{R \rightsquigarrow s'} M_{s'} - e_{s \rightsquigarrow R} M_s \leq 0. \quad (\text{B.1})$$

Proof. Hereafter we let \mathcal{U} denote the set of causal units in the R-block under consideration. Given the hypothesis, we want to show the existence of positive numbers $\{M_s\}_{s \in \mathcal{S}^*}$ such that

$$\frac{M_{s'}}{M_s} \leq \frac{e_{s \rightsquigarrow R}}{f_{R \rightsquigarrow s'}}, \quad \forall s \rightsquigarrow R \rightsquigarrow s' \in \mathcal{U} \quad (\text{B.2})$$

or, equivalently,

$$\ln M_{s'} - \ln M_s \leq \ln \frac{e_{s \rightsquigarrow R}}{f_{R \rightsquigarrow s'}}, \quad \forall s \rightsquigarrow R \rightsquigarrow s' \in \mathcal{U}. \quad (\text{B.3})$$

Now let $\{\omega_s\}_{s \in \mathcal{S}^*}$ be the standard basis for $\mathbb{R}^{\mathcal{S}^*}$, let $\{\epsilon_{s \rightsquigarrow R \rightsquigarrow s'}\}_{s \rightsquigarrow R \rightsquigarrow s' \in \mathcal{U}}$ be the standard basis for $\mathbb{R}^{\mathcal{U}}$, let $T : \mathbb{R}^{\mathcal{S}^*} \rightarrow \mathbb{R}^{\mathcal{U}}$ be defined by

$$Tq := \sum_{s \rightsquigarrow R \rightsquigarrow s' \in \mathcal{U}} (\omega_{s'} - \omega_s) \cdot q \epsilon_{s \rightsquigarrow R \rightsquigarrow s'}, \quad (\text{B.4})$$

and let $z \in \mathbb{R}^{\mathcal{U}}$ be defined by

$$z := \sum_{s \rightsquigarrow R \rightsquigarrow s' \in \mathcal{U}} \ln \frac{e_{s \rightsquigarrow R}}{f_{R \rightsquigarrow s'}} \epsilon_{s \rightsquigarrow R \rightsquigarrow s'}. \quad (\text{B.5})$$

The existence of positive numbers $\{M_s\}_{s \in \mathcal{S}^*}$ satisfying (B.3) is readily seen to be equivalent to the existence of $q^* \in \mathbb{R}^{\mathcal{S}^*}$ satisfying

$$Tq^* \leq z, \quad (\text{B.6})$$

for then we can take $M_s = \exp q_s^*$, $\forall s \in \mathcal{S}^*$ to meet the requirements of (B.3).

However, by a theorem of Gale [13, p. 46], the existence of such a q^* is equivalent to the *non-existence* of $p \in \ker T^T \cap \overline{\mathbb{R}}_+^{\mathcal{U}}$ satisfying

$$p \cdot z < 0. \quad (\text{B.7})$$

In our case, $T^T : \mathbb{R}^{\mathcal{U}} \rightarrow \mathbb{R}^{\mathcal{S}^*}$ is given by

$$T^T x := \sum_{s \rightsquigarrow R \rightsquigarrow s' \in \mathcal{U}} x_{s \rightsquigarrow R \rightsquigarrow s'} (\omega_{s'} - \omega_s). \quad (\text{B.8})$$

We will say that $c \in \overline{\mathbb{R}}_+^{\mathcal{U}}$ is a *directed cycle vector* if, in the R-block under study, there is a directed cycle such that $c_{s' \rightsquigarrow R \rightsquigarrow s} = 1$ if $s' \rightsquigarrow R \rightsquigarrow s$ is a causal unit in the cycle and is zero otherwise. It is easy to see that every directed cycle vector is a member of $\ker T^T \cap \overline{\mathbb{R}}_+^{\mathcal{U}}$. In fact, as we show in Lemma B.1 below, every nonzero member of $\ker T^T \cap \overline{\mathbb{R}}_+^{\mathcal{U}}$ is a positive linear combination of directed cycle vectors.

Suppose that $p \in \ker T^T \cap \overline{\mathbb{R}}_+^{\mathcal{U}}$ satisfies condition (B.7), and let

$$p = \sum_{\theta=1}^k \alpha_\theta c_\theta \quad (\text{B.9})$$

be a representation of p as a positive linear combination of directed cycle vectors. Then we must have

$$p \cdot z = \sum_{\theta=1}^k \alpha_\theta (c_\theta \cdot z) < 0, \quad (\text{B.10})$$

where all the α_θ are positive. On the other hand, (B.10) is contradicted by the fact that each $c_\theta \cdot z$ is non-negative: To see this, suppose that, for a particular θ , the directed cycle corresponding to c_θ is

$$s_1 \rightsquigarrow R_1 \rightsquigarrow s_2 \rightsquigarrow R_2 \cdots \rightsquigarrow s_n \rightsquigarrow R_n \rightsquigarrow s_1. \quad (\text{B.11})$$

Then

$$c_\theta \cdot z = \sum_{i=1}^n \ln \frac{e_{s_i \rightsquigarrow R_i}}{f_{R_i \rightsquigarrow s_{i+1}}} = -\ln \prod_{i=1}^n \frac{f_{R_i \rightsquigarrow s_{i+1}}}{e_{s_i \rightsquigarrow R_i}} \geq 0, \quad (\text{B.12})$$

with the last inequality coming from the fact that no directed cycle in the R-block is stoichiometrically expansive. Apart from proof of Lemma B.1, which appears below, this concludes the proof of Proposition 5.12. \square

Lemma B.1. *Every nonzero member of $\ker T^T \cap \overline{\mathbb{R}}_+^{\mathcal{U}}$ is a positive linear combination of directed cycle vectors.*

Proof. Here we use the terminology and results in [13, Chapter 2]. A vector in $\ker T^T \cap \overline{\mathbb{R}}_+^{\mathcal{U}}$ is *extreme* if it cannot be written as the sum of two linearly independent vectors of $\ker T^T \cap \overline{\mathbb{R}}_+^{\mathcal{U}}$. Because $\ker T^T \cap \overline{\mathbb{R}}_+^{\mathcal{U}}$ is a pointed finite cone (sometimes called a pointed polyhedral cone), any vector within it is the sum of extreme vectors of $\ker T^T \cap \overline{\mathbb{R}}_+^{\mathcal{U}}$. We will be finished if we can show that every nonzero extreme vector of $\ker T^T \cap \overline{\mathbb{R}}_+^{\mathcal{U}}$ is a positive multiple of a directed cycle vector.

Suppose, then, that x^* is a nonzero extreme vector of $\ker T^T \cap \overline{\mathbb{R}}_+^{\mathcal{U}}$. Thus, x^* must be non-negative and satisfy the equation

$$T^T x^* = \sum_{s \rightsquigarrow R \rightsquigarrow s' \in \mathcal{U}} x_{s \rightsquigarrow R \rightsquigarrow s'}^* (\omega_{s'} - \omega_s) = 0. \quad (\text{B.13})$$

Let \mathcal{U}^* denote the support of x^* , and let $\mathbb{R}_*^{\mathcal{U}}$ be the linear subspace of $\mathbb{R}^{\mathcal{U}}$ consisting of all vectors whose support is a subset of \mathcal{U}^* . That is,

$$\mathbb{R}_*^{\mathcal{U}} := \{x \in \mathbb{R}^{\mathcal{U}} : x_{s \rightsquigarrow R \rightsquigarrow s'} = 0 \text{ when } s \rightsquigarrow R \rightsquigarrow s' \notin \mathcal{U}^*\}. \quad (\text{B.14})$$

Moreover, let $\overline{\mathbb{R}}_{+*}^{\mathcal{U}}$ denote the set of vectors of $\mathbb{R}_*^{\mathcal{U}}$ having exclusively non-negative components. We denote by $T_*^T : \mathbb{R}_*^{\mathcal{U}} \rightarrow \mathbb{R}^{\mathcal{S}}$ the linear map defined by

$$T_*^T x := \sum_{s \rightsquigarrow R \rightsquigarrow s' \in \mathcal{U}^*} x_{s \rightsquigarrow R \rightsquigarrow s'} (\omega_{s'} - \omega_s). \quad (\text{B.15})$$

Because the support of x^* is \mathcal{U}^* , it is easy to see that $T_*^T x^* = T^T x^* = 0$. Thus, the dimension of $\ker T_*^T$ is at least one.

In fact if, as has been supposed, x^* is an extreme vector of $\ker T^T \cap \overline{\mathbb{R}}_+^{\mathcal{U}}$, then the dimension of $\ker T_*^T$ must be precisely one: If not, then there is nonzero vector $d \in \ker T_*^T \subset \mathbb{R}_+^{\mathcal{U}}$ that is not collinear with x^* . By choosing $\epsilon > 0$ sufficiently small, we can construct another vector $x^1 := x^* + \epsilon d$ that also resides in $\ker T_*^T$ and that has $x_{s \rightsquigarrow R \rightsquigarrow s'}^1 > 0$ for each $s \rightsquigarrow R \rightsquigarrow s' \in \mathcal{U}^*$. Because d is not collinear with x^* , neither is x^1 . By choosing $\rho > 0$ sufficiently small, the vector $x^2 := x^* - \rho x^1 \in \ker T_*^T$ can also be made to have positive components on \mathcal{U}^* . Since both x_1 and x_2 are members of $\overline{\mathbb{R}}_{+*}^{\mathcal{U}}$ (and hence of $\overline{\mathbb{R}}_+^{\mathcal{U}}$) and since both are members of $\ker T_*^T$ (and hence of $\ker T^T$), both are members of $\ker T^T \cap \overline{\mathbb{R}}_+^{\mathcal{U}}$. Moreover, since $x^* = \rho x_1 + x_2$, x^* is the sum of two vectors in $\ker T^T \cap \overline{\mathbb{R}}_+^{\mathcal{U}}$ that are not collinear with it (and, therefore, not collinear with each other). This implies that x^* is not extreme, which contradicts what we had supposed. Thus, $\dim \ker T_*^T = 1$.

Now T_*^T can be identified with the *incidence map* [3] of a directed graph \bar{G} having as its vertices the species of \mathcal{U}^* and as edges the directed causal units contained in \mathcal{U}^* . It follows from standard graph theoretical arguments — see Chapters 4 and 5 in [3] — that the kernel of the incidence map of a directed graph (when it is singular) has a basis consisting of *cycle vectors*. Each vector c of such a basis has support on the edges of a distinct (not necessarily directed) cycle of the graph and has components related to the cycle in following way: The cycle is given an orientation (e.g. “clockwise”) and the component of c corresponding to a particular edge in the cycle is +1 [respectively, -1] if the edge’s direction agrees [disagrees] with the chosen orientation.

Because $\dim \ker T_*^T = 1$, every vector in $\ker T_*^T$ is a multiple of a single cycle vector c^* , corresponding to a cycle in \bar{G} made up of edges (causal units) in \mathcal{U}^* . Because x^* is a member $\ker T_*^T$, it is a non-zero multiple of c^* . Moreover, because the components of x^* corresponding to members of \mathcal{U}^* are all positive, it must be the case that all components of c^* corresponding to members of \mathcal{U}^* also have the same sign, which is to say that the directions of members of \mathcal{U}^* are consistent with a fixed cycle orientation (clockwise or counterclockwise). That is, the cycle in \bar{G} formed by members of \mathcal{U}^* is directed. Thus, we can write $x^* = \alpha c^*$, where α is positive and c^* is the directed cycle vector corresponding to the underlying cycle in \bar{G} , taken with

its native \rightsquigarrow orientation. □

C Proof of Lemma 6.2

Here we prove Lemma 6.2, which is repeated below:

Lemma 6.2. *Suppose that a fully open reaction network with true chemistry $\{\mathcal{S}, \mathcal{C}, \mathcal{R}\}$ is not strongly concordant. Then there is another true chemistry $\{\mathcal{S}, \bar{\mathcal{C}}, \bar{\mathcal{R}}\}$ whose fully open extension is discordant and whose SR Graph is identical to a subgraph of the SR Graph for $\{\mathcal{S}, \mathcal{C}, \mathcal{R}\}$, apart perhaps from changes in certain arrow directions within the reaction vertices.*

Suppose that, for a fully open network, the true chemistry $\{\mathcal{S}, \mathcal{C}, \mathcal{R}\}$ is not strongly concordant. We let \mathcal{R}_{aug} denote the set of all reactions in the fully open network whose true chemistry is $\{\mathcal{S}, \mathcal{C}, \mathcal{R}\}$, including synthesis-degradation reactions of the form $0 \rightarrow s$ and $s \rightarrow 0$. To say that the fully open network is not strongly concordant is to say that there is a non-zero $\sigma \in \mathbb{R}^{\mathcal{S}}$ and numbers $\{\alpha_{y \rightarrow y'}\}_{y \rightarrow y' \in \mathcal{R}_{aug}}$ such that

$$\sum_{y \rightarrow y' \in \mathcal{R}_{aug}} \alpha_{y \rightarrow y'} (y' - y) = 0, \quad (\text{C.1})$$

and, in addition,

- (i) For each $y \rightarrow y' \in \mathcal{R}_{aug}$ such that $\alpha_{y \rightarrow y'} > 0$ there exists a species $s \in \text{supp}(y - y')$ for which $\text{sgn } \sigma_s = \text{sgn}(y - y')_s$.
- (ii) For each $y \rightarrow y' \in \mathcal{R}_{aug}$ such that $\alpha_{y \rightarrow y'} < 0$ there exists a species $s \in \text{supp}(y - y')$ for which $\text{sgn } \sigma_s = -\text{sgn}(y - y')_s$.
- (iii) For each $y \rightarrow y' \in \mathcal{R}_{aug}$ such that $\alpha_{y \rightarrow y'} = 0$, either (a) $\sigma_s = 0$ for all $s \in \text{supp } y$, or (b) there exist species $s, s' \in \text{supp}(y - y')$ for which $\text{sgn } \sigma_s = \text{sgn}(y - y')_s$ and $\text{sgn } \sigma_{s'} = -\text{sgn}(y - y')_{s'}$.

Our aim will be to construct a true chemistry $\{\mathcal{S}, \bar{\mathcal{C}}, \bar{\mathcal{R}}\}$ with a discordant fully open extension and with $\bar{\mathcal{R}}$ resulting from removal of certain reactions in \mathcal{R} , retention of certain other reactions in \mathcal{R} , and replacement of still other reactions in \mathcal{R} by their reverses. It is easy to see that the resulting true chemistry $\{\mathcal{S}, \bar{\mathcal{C}}, \bar{\mathcal{R}}\}$ will have an SR Graph that is identical to a subgraph of the SR Graph for $\{\mathcal{S}, \mathcal{C}, \mathcal{R}\}$, up to modification of arrow directions within the reaction vertices.

To produce the discordance we will want to show that, with $\bar{\mathcal{R}}_{aug}$ denoting the reaction set $\bar{\mathcal{R}}$ augmented by the degradation reactions $\{s \rightarrow 0, \forall s \in \mathcal{S}\}$, there exist numbers $\{\bar{\alpha}_{y \rightarrow y'}\}_{y \rightarrow y' \in \bar{\mathcal{R}}_{aug}}$ satisfying

$$\sum_{y \rightarrow y' \in \bar{\mathcal{R}}_{aug}} \bar{\alpha}_{y \rightarrow y'} (y' - y) = 0, \quad (\text{C.2})$$

and, in addition (with σ as before),

- (i) For each $y \rightarrow y' \in \bar{\mathcal{R}}_{aug}$ such that $\bar{\alpha}_{y \rightarrow y'} \neq 0$, $\text{supp } y$ contains a species s for which $\text{sgn } \sigma_s = \text{sgn } \bar{\alpha}_{y \rightarrow y'}$.
- (ii) For each $y \rightarrow y' \in \bar{\mathcal{R}}_{aug}$ such that $\bar{\alpha}_{y \rightarrow y'} = 0$, $\sigma_s = 0$ for all $s \in \text{supp } y$ or else $\text{supp } y$ contains species s and s' for which $\text{sgn } \sigma_s = -\text{sgn } \sigma_{s'}$, both not zero.

The resulting fully open reaction network, with reaction set $\bar{\mathcal{R}}_{aug}$, will then be discordant. (Recall Definition 4.1, keeping in mind that the stoichiometric subspace of the fully open network is $\mathbb{R}^{\mathcal{S}}$.)

The construction of $\bar{\mathcal{R}}_{aug}$, which draws on conditions (i) – (iii) just below (C.1), proceeds through sequential retention, removal, or reversal of reactions in \mathcal{R}_{aug} in a procedure we will now describe, along with an indication of how the numbers $\{\bar{\alpha}_{y \rightarrow y'}\}_{y \rightarrow y' \in \bar{\mathcal{R}}_{aug}}$ are to be assigned:

1. For each $y \rightarrow y' \in \mathcal{R}$ that is irreversible do the following:
 - (A) If $\alpha_{y \rightarrow y'} \neq 0$ and there exists $s \in \text{supp } y$ with $\text{sgn } \sigma_s = \text{sgn } \alpha_{y \rightarrow y'}$ retain $y \rightarrow y'$ and set $\bar{\alpha}_{y \rightarrow y'} = \alpha_{y \rightarrow y'}$.
 - (B) If $\alpha_{y \rightarrow y'} \neq 0$ and there does not exist $s \in \text{supp } y$ with $\text{sgn } \sigma_s = \text{sgn } \alpha_{y \rightarrow y'}$ (in which case there exists $s' \in \text{supp } y'$ with $\text{sgn } \sigma_{s'} = -\text{sgn } \alpha_{y \rightarrow y'}$) replace $y \rightarrow y'$ by $y' \rightarrow y$, and set $\bar{\alpha}_{y' \rightarrow y} = -\alpha_{y \rightarrow y'}$.
 - (C) If $\alpha_{y \rightarrow y'} = 0$ remove $y \rightarrow y'$.
2. For each reversible reaction pair $y \rightleftharpoons y' \in \mathcal{R}$ do the following:
 - (A) If $\alpha_{y \rightarrow y'} \neq \alpha_{y' \rightarrow y}$ and the complexes have been labeled so that $|\alpha_{y \rightarrow y'}| > |\alpha_{y' \rightarrow y}|$ (whereupon $\text{sgn}(\alpha_{y \rightarrow y'} - \alpha_{y' \rightarrow y}) = \text{sgn } \alpha_{y \rightarrow y'}$) then

- (i) If there exists $s \in \text{supp } y$ with $\text{sgn } \sigma_s = \text{sgn } \alpha_{y \rightarrow y'}$ then retain $y \rightarrow y'$, remove $y' \rightarrow y$, and set $\bar{\alpha}_{y \rightarrow y'} = \alpha_{y \rightarrow y'} - \alpha_{y' \rightarrow y}$.
 - (ii) If there does not exist $s \in \text{supp } y$ with $\text{sgn } \sigma_s = \text{sgn } \alpha_{y \rightarrow y'}$ (in which case there exists $s' \in \text{supp } y'$ with $\text{sgn } \sigma_{s'} = -\text{sgn } \alpha_{y \rightarrow y'}$) then retain $y' \rightarrow y$, remove $y \rightarrow y'$, and set $\bar{\alpha}_{y' \rightarrow y} = \alpha_{y' \rightarrow y} - \alpha_{y \rightarrow y'}$.
- (B) If $\alpha_{y \rightarrow y'} = \alpha_{y' \rightarrow y}$ then remove both $y \rightarrow y'$ and $y' \rightarrow y$.
3. For each degradation reaction $s \rightarrow 0$ that is irreversible in \mathcal{R}_{aug} , retain $s \rightarrow 0$ and set $\bar{\alpha}_{s \rightarrow 0} = \alpha_{s \rightarrow 0}$.
4. For each reversible pair $s \rightleftharpoons 0 \in \mathcal{R}_{aug}$, do the following:
- (A) If $\alpha_{s \rightarrow 0} \neq 0$ (in which case $\alpha_{0 \rightarrow s} = 0$ or $\text{sgn } \alpha_{0 \rightarrow s} = -\text{sgn } \alpha_{s \rightarrow 0}$), retain $s \rightarrow 0$, remove $0 \rightarrow s$, and set $\bar{\alpha}_{s \rightarrow 0} = \alpha_{s \rightarrow 0} - \alpha_{0 \rightarrow s}$.
 - (B) If $\alpha_{s \rightarrow 0} = 0$ (in which case $\alpha_{0 \rightarrow s} = 0$), retain $s \rightarrow 0$, remove $0 \rightarrow s$, and set $\bar{\alpha}_{s \rightarrow 0} = 0$.

That (C.2) is satisfied follows from the construction and (C.1). That the two conditions just below (C.2) are satisfied also follows from the construction.

Acknowledgment

We are grateful to Daniel Knight for helpful discussions and to Uri Alon for his support and encouragement of this work.

References

- [1] Banaji, M., Craciun, G.: Graph-theoretic approaches to injectivity and multiple equilibria in systems of interacting elements. *Communications in Mathematical Sciences* **7**(4), 867–900 (2009)
- [2] Banaji, M., Craciun, G.: Graph-theoretic criteria for injectivity and unique equilibria in general chemical reaction systems. *Advances in Applied Mathematics* **44**(2), 168–184 (2010)

- [3] Biggs, N.: Algebraic Graph Theory, second edn. Cambridge University Press (1993)
- [4] Bondy, A., Murty, U.: Graph Theory. Springer (2010)
- [5] Craciun, G., Feinberg, M.: Multiple equilibria in complex chemical reaction networks. I. the injectivity property. *SIAM Journal on Applied Mathematics* **65**, 1526–1546 (2005)
- [6] Craciun, G., Feinberg, M.: Multiple equilibria in complex chemical reaction networks: extensions to entrapped species models. *IEE Proc. Syst. Biol* **153**, 179–186 (2006)
- [7] Craciun, G., Feinberg, M.: Multiple equilibria in complex chemical reaction networks. II. the species-reaction graph. *SIAM Journal on Applied Mathematics* **66**, 1321–1338 (2006)
- [8] Craciun, G., Feinberg, M.: Multiple equilibria in complex chemical reaction networks: Semiopen mass action systems. *SIAM Journal on Applied Mathematics* **70**(6), 1859–1877 (2010)
- [9] Craciun, G., Tang, Y., Feinberg, M.: Understanding bistability in complex enzyme-driven reaction networks. *Proceedings of the National Academy of Sciences* **103**, 8697–8702 (2006)
- [10] Feinberg, M.: Lectures on chemical reaction networks (1979). Written version of lectures given at the Mathematical Research Center, University of Wisconsin, Madison, WI Available at www.chbmeng.ohio-state.edu/~feinberg/LecturesOnReactionNetworks
- [11] Feinberg, M.: Necessary and sufficient conditions for detailed balancing in mass action systems of arbitrary complexity. *Chemical Engineering Science* **44**, 1819–1827 (1989)
- [12] Feinberg, M., Horn, F.J.M.: Chemical mechanism structure and the coincidence of the stoichiometric and kinetic subspaces. *Archive for Rational Mechanics and Analysis* **66**, 83–97 (1977)
- [13] Gale, D.: The Theory of Linear Economic Models. University of Chicago Press (1960)

- [14] Ji, H.: Uniqueness of equilibria for complex chemical reaction networks. Ph.D. thesis, Department of Mathematics, The Ohio State University (2011)
- [15] Ji, H., Ellison, P., Knight, D., Feinberg, M.: The chemical reaction network toolbox, version 2.1 (2011). Available at <http://www.chbmeng.ohio-state.edu/~feinberg/crntwin/>
- [16] Schlosser, P.M.: A graphical determination of the possibility of multiple steady states in complex isothermal CFSTRs. Ph.D. thesis, University of Rochester (1988)
- [17] Schlosser, P.M., Feinberg, M.: A theory of multiple steady states in isothermal homogeneous CFSTRs with many reactions. *Chemical Engineering Science* **49**(11), 1749–1767 (1994)
- [18] Shinar, G., Feinberg, M.: Concordant chemical reaction networks. arXiv:1109.2923 (2011). URL <http://arxiv.org/abs/1109.2923>. Under revision for *Mathematical Biosciences* at the request of the editor (2012).